



DEPARTMENT OF REGULATORY AND ECONOMIC RESOURCES (RER)
BOARD AND CODE ADMINISTRATION DIVISION

NOTICE OF ACCEPTANCE (NOA)

MIAMI-DADE COUNTY
PRODUCT CONTROL SECTION
11805 SW 26 Street, Room 208
Miami, Florida 33175-2474
T (786) 315-2590 F (786) 315-2599

www.miamidade.gov/economy

Nichiha USA, Inc.
6465 E. Johns Crossing
Johns Creek, GA 30097

SCOPE:

This NOA is being issued under the applicable rules and regulations governing the use of construction materials. The documentation submitted has been reviewed and accepted by Miami-Dade County RER-Product Control Section to be used in Miami Dade County and other areas where allowed by the Authority Having Jurisdiction (AHJ).

This NOA shall not be valid after the expiration date stated below. The Miami-Dade County Product Control Section (In Miami Dade County) and/or the AHJ (in areas other than Miami Dade County) reserve the right to have this product or material tested for quality assurance purposes. If this product or material fails to perform in the accepted manner, the manufacturer will incur the expense of such testing and the AHJ may immediately revoke, modify, or suspend the use of such product or material within their jurisdiction. RER reserves the right to revoke this acceptance, if it is determined by Miami-Dade County Product Control Section that this product or material fails to meet the requirements of the applicable building code.

This product is approved as described herein, and has been designed to comply with the Florida Building Code, including the High Velocity Hurricane Zone.

DESCRIPTION: NichiProducts™ Fiber-Cement Siding

APPROVAL DOCUMENT: Drawing No. ITS N1090403, titled "NichiBoard", sheets 1 and 2 of 2 and Drawing No. ITS N2090403, titled "NichiPanel", sheets 1 and 2 of 2, both dated 03/16/2009, prepared by Nichiha USA, Inc, signed and sealed by Carl D. Fussner, P.E. on 10/13/2015, bearing the Miami-Dade County Product Control revision stamp with the Notice of Acceptance number and expiration date by the Miami-Dade County Product Control Section.

MISSILE IMPACT RATING: Large and Small Missile Impact Resistant

LABELING: Each unit shall bear a permanent label with the manufacturer's name or logo, city, state and following statement: "Miami-Dade County Product Control Approved", unless otherwise noted herein.

RENEWAL of this NOA shall be considered after a renewal application has been filed and there has been no change in the applicable building code negatively affecting the performance of this product.

TERMINATION of this NOA will occur after the expiration date or if there has been a revision or change in the materials, use, and/or manufacture of the product or process. Misuse of this NOA as an endorsement of any product, for sales, advertising or any other purposes shall automatically terminate this NOA. Failure to comply with any section of this NOA shall be cause for termination and removal of NOA.

ADVERTISEMENT: The NOA number preceded by the words Miami-Dade County, Florida, and followed by the expiration date may be displayed in advertising literature. If any portion of the NOA is displayed, then it shall be done in its entirety.

INSPECTION: A copy of this entire NOA shall be provided to the user by the manufacturer or its distributors and shall be available for inspection at the job site at the request of the Building Official.

This NOA revises NOA # 14-0715.03 and consists of this page 1 and evidence pages E-1 and E-2, as well as approval document mentioned above.

The submitted documentation was reviewed by **Carlos M. Utrera, P.E.**



Handwritten signature and date: 02/11/2016

NOA No. 15-1102.14
Expiration Date: July 22, 2019
Approval Date: February 18, 2016
Page 1

NOTICE OF ACCEPTANCE: EVIDENCE SUBMITTED

A. DRAWINGS

1. Drawing No. **ITS N1090403**, titled "NichiBoard", sheets 1 and 2 of 2 and Drawing No. **ITS N2090403**, titled "NichiPanel", sheets 1 and 2 of 2, both dated 03/16/2009, prepared by Nichiha USA, Inc, signed and sealed by Carl D. Fussner, P.E. on 10/13/2015.

B. TESTS "Submitted under NOA # 09-0511.01"

1. Test reports on 1) Air Infiltration Test, per FBC, TAS 202-94
2) Uniform Static Air Pressure Test, Loading per FBC TAS 202-94
3) Water Resistance Test, per FBC, TAS 202-94
4) Large Missile Impact Test per FBC, TAS 201-94
5) Cyclic Wind Pressure Loading per FBC, TAS 203-94
along with marked-up drawings and installation diagram of NichiProducts Fiber-Cement Panels, prepared by Intertek Testing Services NA LTD, Report No. **3145127COQ-004A**, dated 08/07/08, signed and sealed by Rick Curkeet, P.E.
2. Test reports on 1) Uniform Static Air Pressure Test, Loading per FBC TAS 202-94
2) Large Missile Impact Test per FBC, TAS 201-94
3) Cyclic Wind Pressure Loading per FBC, TAS 203-94
along with marked-up drawings and installation diagram of NichiBoards and EcoPlanks, prepared by Intertek Testing Services NA LTD, Report No. **3145127COQ-004B**, dated 10/24/08, signed and sealed by Rick Curkeet, P.E.
3. Test report on Standard Specification for Flat Non-Asbestos Fiber-Cement Sheets of NichiProducts Fiber-Cement Panels, per ASTM C1186-07, prepared by Intertek Testing Services NA LTD, Report No. **3145123COQ-005**, dated 05/20/08, with a revision dated 02/02/09, signed and sealed by Rick Curkeet, P.E.
4. Test report on Surface Burning Characteristics of NichiPanel Fiber-Cement Panels, per ASTM E84-08, prepared by Intertek Testing Services NA LTD, Report No. **3145123COQ-006**, dated 06/25/08, with a revision dated 04/03/09, signed and sealed by Rick Curkeet, P.E.
5. Test report on Standard Test Method for Behavior of Materials in a Vertical Tube Furnace at 750°C of Nichiha M series unprimed cementitious, per ASTM E136-99, prepared by Intertek Testing Services NA LTD, Report No. **3105885COQ-002**, dated 10/26/06, with a revision dated 03/30/09, signed and sealed by Rick Curkeet, P.E.



02/11/2016

Carlos M. Utrera, P.E.
Product Control Examiner
NOA No. 15-1102.14
Expiration Date: July 22, 2019
Approval Date: February 18, 2016

NOTICE OF ACCEPTANCE: EVIDENCE SUBMITTED

C. CALCULATIONS “Submitted under NOA # 14-0715.03”

1. Anchor calculations prepared by Progressive Engineering, Inc., dated 10/22/2014, signed and sealed by Carl D. Fussner, P.E.

“Submitted under NOA # 09-0511.01”

2. Anchor analyses prepared by Category 5 Engineering Services, Inc., dated 04/03/2009, signed and sealed by Emma T. Mellinger, P.E.

D. QUALITY ASSURANCE

1. Miami-Dade Department of Regulatory and Economic Resources (RER)

E. MATERIAL CERTIFICATIONS

1. None.

F. STATEMENTS

1. Drawing No. ITS N1090403 and ITS N2090403 statements of code conformance to the 5th edition (2014) FBC issued by Nichiha USA, Inc, dated 03/16/2009, signed and sealed by Carl D. Fussner, P.E. on 10/13/2015.
2. Statement letter of no financial interest issued by Progressive Engineering, Inc., dated 10/13/2015, signed and sealed by Carl D. Fussner, P.E.



02/11/2016

Carlos M. Utrera, P.E.
Product Control Examiner
NOA No. 15-1102.14
Expiration Date: July 22, 2019
Approval Date: February 18, 2016

12" Panels Shown

5 1/4" Panels Shown

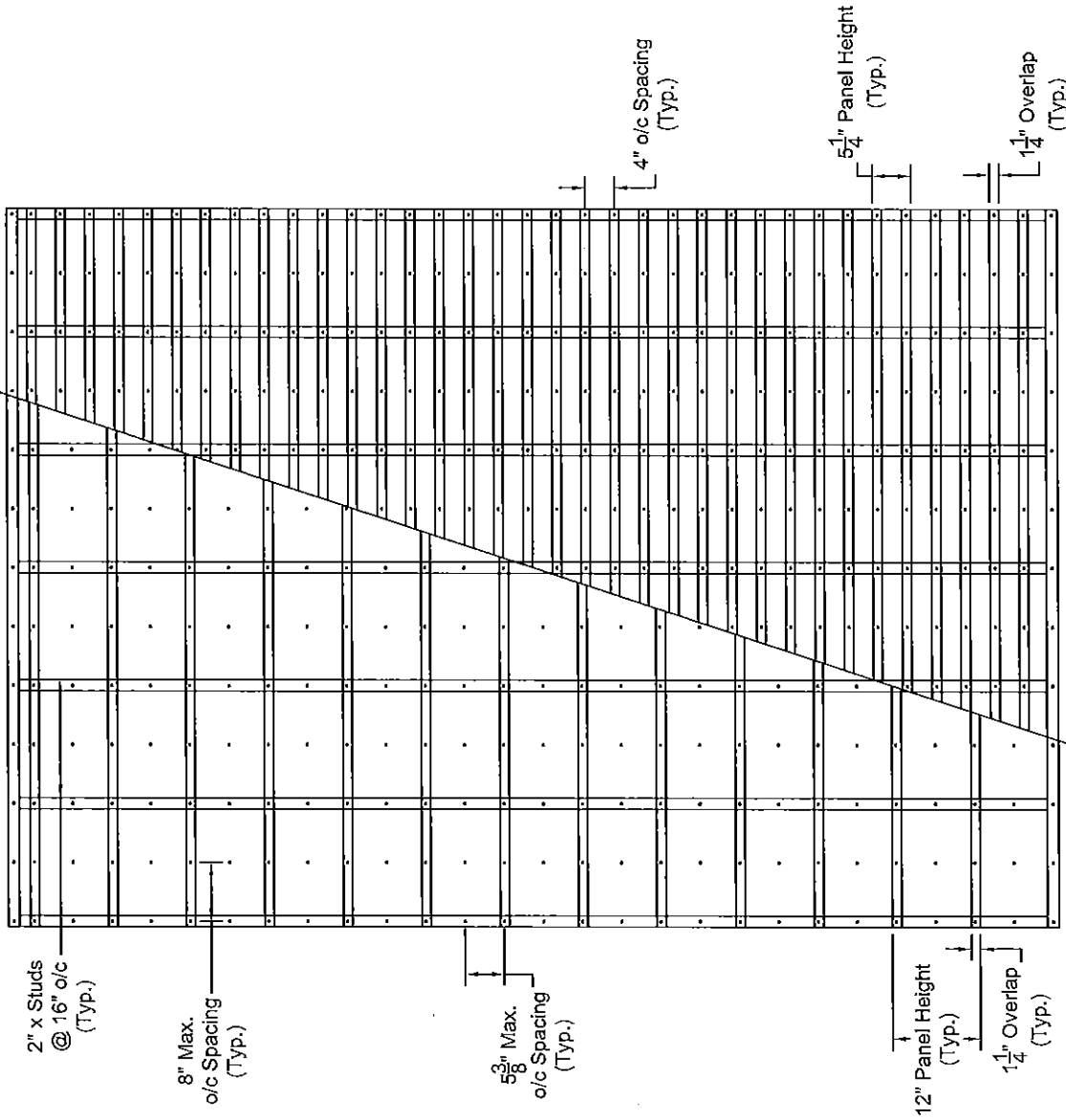

DESCRIPTION and SPECIFICATION NichiBoard lap siding material is a non-asbestos fiber cement product tested in accordance with ASTM C-1185 & ASTM C-1186 Type A meeting the requirements of the 2014 Florida Building Code (HVHZ). Boards are available in a variety of widths within the maximum and minimum dimensions specified below.

Plank Dimensions		
Width	Length	Thickness
5 1/4" Min.	12'	5/16"
12" Max.	12'	5/16"

Design Pressure Rating -125 psf

LIMITATIONS

- All installation shall be done in accordance with this Notice of Acceptance, the manufacturer's installation recommendations, and the applicable sections of the 2014 Florida Building Code including High Velocity Hurricane Zone where Required.
- Wood studs and plywood sheathing supporting NichiBoard and EcoPlank siding shall conform to the 2014 Florida Building Code (including the HVHZ where required), and the requirements of this Notice of Acceptance (See Note Sheet 2).
- Siding installed as specified herein shall be classified as Large Missile Impact Resistant.

PRODUCT REVISED
 as complying with the Florida Building Code
 Acceptance No 15-1102.14
 Expiration Date 01/22/2019
 By *[Signature]*
 Michael T. Clark Product Control

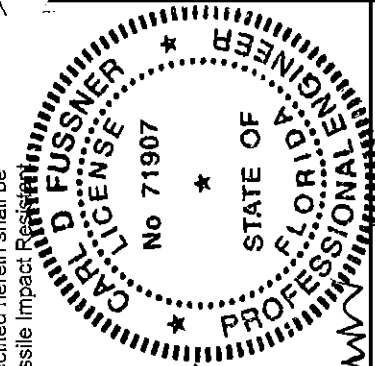

[Signature]
 Manufacturer:
NICHIHA USA, INC.
 6465 E. Johns Crossing, Johns Creek, GA. 30097

Dwg: ITS N1090403
 Sheet: 1 of 2
 Revision: 0
 Date: March 16, 2009



NichiBoard
 Fiber Cement Siding

OCT 13 2015
 FL CCA 27447

NICHIBOARD SIDING INSTALLATION

- The boards shall be applied horizontally commencing from the bottom course of the wall.
- Each successive course shall overlap the prior course by 1 ¼".
- Any vertical joints shall be over framing members, with fasteners either side of the joint.
- The planks shall be installed over 5/8" APA rated exterior-grade plywood (SG = 0.50 min.) supported by 2" x 4" minimum wood studs spaced a maximum of 16" o.c.
- The siding shall be fastened through over-lapping planks with 8d x 2 1/2" long common nails over wood studs.
- A row of fasteners shall be placed in the overlap of each course, spaced 8" o/c in the horizontal direction.
- Successive rows of fasteners shall be spaced not more than 5 3/8" o/c. (boards greater than 6 5/8" in width shall require an additional row of fasteners in the center of the plank).
- A distance of between 3/4" and 2" from the edges shall always be observed.

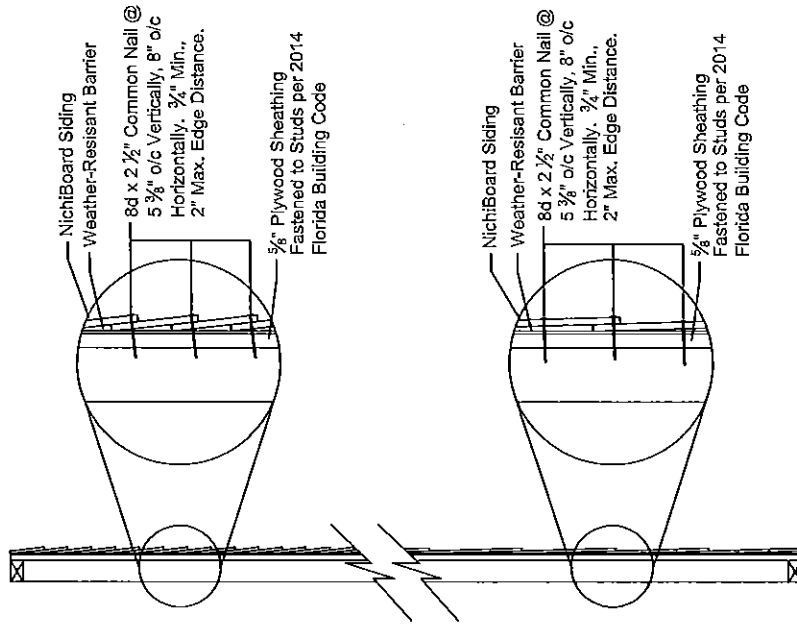

PLYWOOD SHEATHING NOTE

NichiBoard Fiber-Cement Lap Siding is designed to be installed to plywood sheathing. Such plywood shall be 5/8" (5-ply) minimum, APA rated sheathing, Structural 1 grade, with a specified specific gravity of 0.50 or greater (e.g. Douglas Fir-Larch or Southern Pine). Use of other grade plywood shall require a site-specific fastener design for the siding attachment, signed and sealed by a Florida Registered Professional Engineer.

Such plywood sheathing shall be supported by framing consisting of 2" x 4" minimum wood studs, or 2" x 6" 18ga metal studs, each at 16" o/c. Plywood shall be attached to the framing studs in accordance with the 2014 Florida Building Code (High Velocity Hurricane Zone).

PRODUCT REVISED
as complying with the Florida
Building Code
Acceptance No 15-1102-14
Expiration Date 01/22/2019

By *[Signature]*
NichiBoard Product Control



DWG: ITS N1090403
Sheet: 2 of 2
Revision: 0
Date: March 16, 2009

Product: NichiBoard
Fiber Cement Siding

Manufacturer:
NICHIBA USA, INC.
6465 E. Johns Crossing, Johns Creek, GA, 30097

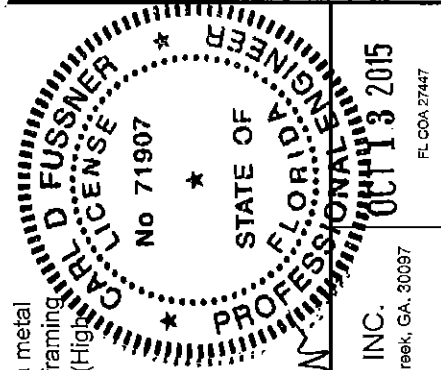

[Signature]

FL-CCA-27447

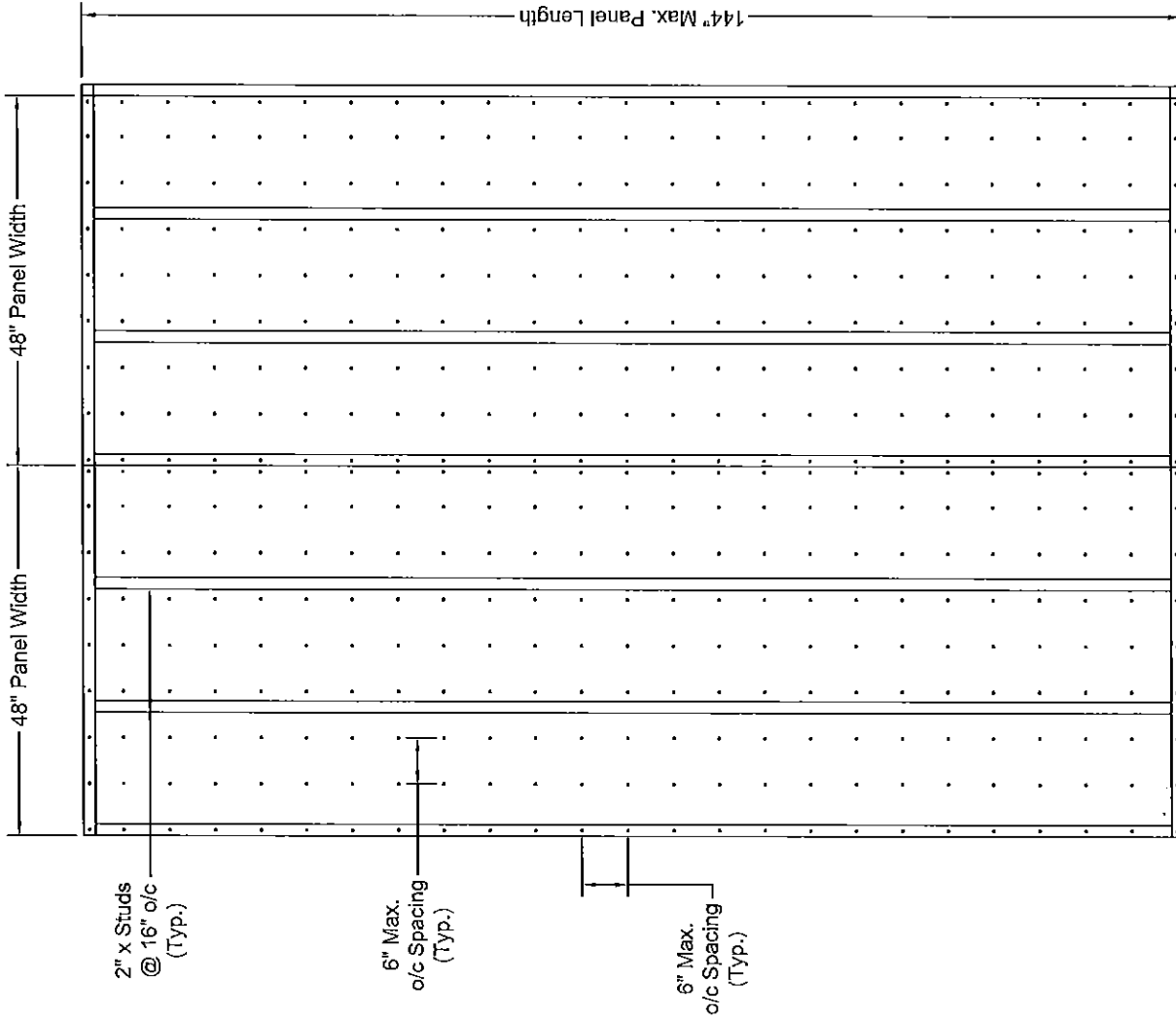

DESCRIPTION and SPECIFICATION
 NichiPanel siding material is a non-asbestos fiber cement product tested in accordance with ASTM C-1185 & ASTM C-1186 Type A meeting the requirements of the 2014 Florida Building Code (HVHZ). Panels are available in four-foot widths within the maximum and minimum dimensions specified below.

Plank Dimensions		
Width	Length	Thickness
48"	8'	5/16"
48"	10'	5/16"
48"	12'	5/16"

Design Pressure Rating -104 psf

LIMITATIONS

- All installation shall be done in accordance with this Notice of Acceptance, the manufacturer's installation recommendations, and the applicable sections of the 2014 Florida Building Code including High Velocity Hurricane Zone where Required.
- Wood studs and plywood sheathing supporting NichiPanel siding shall conform to the 2014 Florida Building Code (including the HVHZ where required), and the requirements of this Notice of Acceptance (See Note Sheet 2).
- Siding installed as specified herein shall be classified as Large Missile Impact Resistant.

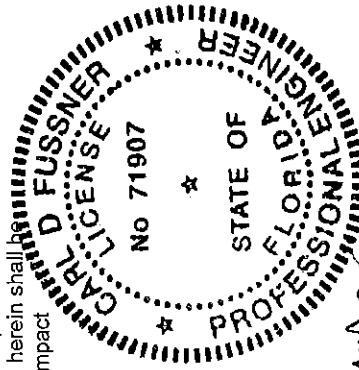

PRODUCT REVISED
 as complying with the Florida Building Code
 Acceptance No. 15-102-14
 Expiration Date: 01/22/2019
 By: [Signature]
 Manual Trade Product Control

[Signature]

	Dwg: ITS N2090403 Sheet: 1 of 2 Revision: 0 Date: March 16, 2009	Product: NichiPanel Fiber Cement Siding	Manufacturer: NICHHA USA, INC. 6465 E. Johns Crossing, Johns Creek, GA, 30097	OCT 13 2015 FL COA 27447
	Design Pressure Rating: -104 psf			

NICHIPANEL SIDING INSTALLATION

- The panels shall be applied vertically, avoiding horizontal joints.
- The panels shall be installed over 5/8" APA rated exterior-grade plywood (SG = 0.50 min.) supported by 2"x4" minimum wood studs spaced a maximum of 16" o.c.
- Fasteners shall be placed at 6" o/c in the vertical direction and 6" o/c in the horizontal direction.
- A distance of between 3/4" and 3" from the edges shall always be observed.

PLYWOOD SHEATHING NOTE

NichiPanel Fiber-Cement Siding is designed to be installed to plywood sheathing. Such plywood shall be 5/8" (5-ply) minimum, APA rated sheathing, Structural 1 grade, with a specified specific gravity of 0.50 or greater (e.g. Douglas Fir-Larch or Southern Pine). Use of other grade plywood shall require a site-specific fastener design for the siding attachment, signed and sealed by a Florida Registered Professional Engineer.

Such plywood sheathing shall be supported by framing consisting of 2" x 4" minimum wood studs, or 2" x 6" 18ga metal studs, each at 16" o/c. Plywood shall be attached to the framing studs in accordance with the 2014 Florida Building Code (High Velocity Hurricane Zone).

PRODUCT REVISED
 as complying with the Florida
 Building Code
 Acceptance No 15-1107-14
 Expiration Date 07/27/2019
 By *[Signature]*
 Means That Product Conform

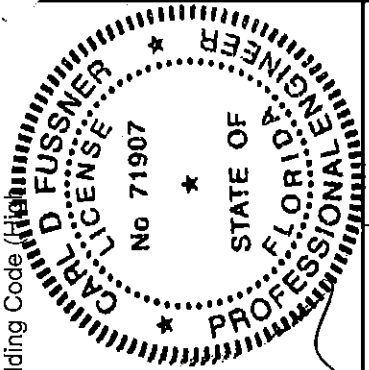

[Signature]
 Manufacturer

NICHIHA USA, INC.

6465 E. Johns Crossing, Johns Creek, GA, 30097

OCT 13 2015

FL OCA 27447

Dwg: ITS N2090403	Product:
Sheet: 2 of 2	
Revised: 0	
Date: March 16, 2009	



NichiPanel
 Fiber Cement Siding

