



DEPARTMENT OF REGULATORY AND ECONOMIC RESOURCES (RER)
BOARD AND CODE ADMINISTRATION DIVISION

NOTICE OF ACCEPTANCE (NOA)

MIAMI-DADE COUNTY
PRODUCT CONTROL SECTION

11805 SW 26 Street, Room 208
Miami, Florida 33175-2474
T (786) 315-2590 F (786) 315-2599

www.miamidade.gov/economy

Berridge Manufacturing Company
6515 Fratt Road
San Antonio, TX 78218

SCOPE:

This NOA is being issued under the applicable rules and regulations governing the use of construction materials. The documentation submitted has been reviewed and accepted by Miami-Dade County RER-Product Control Section to be used in Miami Dade County and other areas where allowed by the Authority Having Jurisdiction (AHJ).

This NOA shall not be valid after the expiration date stated below. The Miami-Dade County Product Control Section (In Miami Dade County) and/or the AHJ (in areas other than Miami Dade County) reserve the right to have this product or material tested for quality assurance purposes. If this product or material fails to perform in the accepted manner, the manufacturer will incur the expense of such testing and the AHJ may immediately revoke, modify, or suspend the use of such product or material within their jurisdiction. RER reserves the right to revoke this acceptance, if it is determined by Miami-Dade County Product Control Section that this product or material fails to meet the requirements of the applicable building code.

This product is approved as described herein and has been designed to comply with the Florida Building Code, including the High Velocity Hurricane Zone.

DESCRIPTION: Berridge "HR-16" Steel Wall & Soffit Panel System

APPROVAL DOCUMENT: Engineering Report No. 17-128-HR16-ER, titled "Berridge "HR-16" Steel Wall & Soffit Panel", sheets 1 through 9 of 9, dated 11/13/2017, prepared by C-Buck Engineering, signed and sealed by James L. Buckner, P.E., bearing the Miami-Dade County Product Control renewal stamp with the Notice of Acceptance number and expiration date by the Miami-Dade County Product Control Section.

MISSILE IMPACT RATING: Large and Small Missile Impact Resistant

LABELING: Each panel shall bear a permanent label with the manufacturer's name or logo, Houston, San Antonio or Seguin, TX, model/series, and following statement: "Miami-Dade County Product Control Approved", unless otherwise noted herein.

LIMITATION: This panel system has not been tested for water and air infiltration.

RENEWAL of this NOA shall be considered after a renewal application has been filed and there has been no change in the applicable building code negatively affecting the performance of this product.

TERMINATION of this NOA will occur after the expiration date or if there has been a revision or change in the materials, use, and/or manufacture of the product or process. Misuse of this NOA as an endorsement of any product, for sales, advertising or any other purposes shall automatically terminate this NOA. Failure to comply with any section of this NOA shall be cause for termination and removal of NOA.

ADVERTISEMENT: The NOA number preceded by the words Miami-Dade County, Florida, and followed by the expiration date may be displayed in advertising literature. If any portion of the NOA is displayed, then it shall be done in its entirety.

INSPECTION: A copy of this entire NOA shall be provided to the user by the manufacturer or its distributors and shall be available for inspection at the job site at the request of the Building Official.

This NOA **renews** NOA #17-1211.14 and consists of this page 1 and evidence pages E-1 and E-2, as well as approval document mentioned above.

The submitted documentation was reviewed by **Carlos M. Utrera, P.E.**



Handwritten signature and date: 02/13/2020

NOA No. 20-0128.05
Expiration Date: March 24, 2025
Approval Date: February 20, 2020
Page 1

NOTICE OF ACCEPTANCE: EVIDENCE SUBMITTED

1. Evidence submitted under previous NOA's
 - A. DRAWINGS "*Submitted under NOA # 15-0421.13*"
 1. Engineering Report No. **09-192-HR16-ER.3**, titled "Berridge "HR-16" Steel Wall & Soffit Panel", sheets 1 through 9 of 9, dated 02/09/2010, with revision 2 dated 04/16/2015, prepared by C-Buck Engineering, signed and sealed by James L. Buckner, P.E.
 - B. TESTS "*Submitted under NOA # 09-1028.07*"
 1. Test reports on 1) Uniform Static Air Pressure Test, Loading per FBC TAS 202-94
2) Large Missile Impact Test per FBC, TAS 201-94
3) Cyclic Wind Pressure Loading per FBC, TAS 203-94
4) Tensile Test per ASTM E8-08
along with marked-up drawings and installation diagram of three HR-16 Steel Siding/Soffit Panels, prepared by Architectural Testing, Inc., Test Report No. **78918.02-801-18**, dated 08/20/2009, signed and sealed by Joseph A. Reed, P.E.
 - C. CALCULATIONS "*Submitted under NOA # 09-1028.07*"
 1. Fastener evaluation calculations, prepared by C-Buck Engineering, dated 10/22/2009, signed and sealed by James L. Buckner, P.E.
 - D. QUALITY ASSURANCE
 1. Miami-Dade Department of Regulatory and Economic Resources (RER)
 - E. MATERIAL CERTIFICATIONS
 1. None.
 - F. STATEMENTS "*Submitted under NOA # 15-0421.13*"
 1. Drawing No. **09-192-HR16-ER.3** statement of code conformance to the 5th edition (2014) FBC issued by C-Buck Engineering, dated 02/09/2012, with revision 2 dated 04/16/2015, signed and sealed by James L. Buckner, P.E.

"Submitted under NOA # 12-0329.10"
 2. Drawing No. **09-192-2** statement of code conformance to 2010 FBC issued by C-Buck Engineering, dated 02/29/2012, signed and sealed by James L. Buckner, P.E.

 - "Submitted under NOA # 09-1028.07"*
 3. Statement letter of no financial interest issued by C-Buck Engineering, dated 10/23/2009, signed and sealed by James L. Buckner, P.E.



Carlos M. Utrera, P.E.
Product Control Examiner
NOA No. 20-0128.05
Expiration Date: March 24, 2025
Approval Date: February 20, 2020

NOTICE OF ACCEPTANCE: EVIDENCE SUBMITTED

2. Evidence submitted under NOA #17-1211.14

A. DRAWINGS

1. Engineering Report No. **17-128-HR16-ER**, titled "Berridge "HR-16" Steel Wall & Soffit Panel", sheets 1 through 9 of 9, dated 11/13/2017, prepared by C-Buck Engineering, signed and sealed by James L. Buckner, P.E.

B. TESTS

1. None.

C. CALCULATIONS

1. None.

D. QUALITY ASSURANCE

1. Miami-Dade Department of Regulatory and Economic Resources (RER)

E. MATERIAL CERTIFICATIONS

1. None.

F. STATEMENTS

1. Statements of code conformance on drawing No. **17-128-HR16-ER**, Section 2.1.1 and 9.1, stating conformance to the 6th edition (2017) FBC issued by C-Buck Engineering, dated 11/13/2017, signed and sealed by James L. Buckner, P.E.



Carlos M. Utrera, P.E.
Product Control Examiner
NOA No. 20-0128.05
Expiration Date: March 24, 2025
Approval Date: February 20, 2020

Engineering Report & Drawings
of
Berridge Manufacturing Company
"HR-16"
Wall & Soffit Panel Assembly
for
Miami-Dade Notice of Acceptance (N.O.A.)

Category: Panels
Sub - Category: Wall

Product: "HR-16" Structural Steel Wall Panel
Material: Steel
Panel Thickness: 24 gauge

Prepared by:
James L. Buckner, P.E.
Florida Professional Engineer # 31242
Project Manager: Diana Galloway
Report No.: 17-128-HR16-ER
Date: 11/13/2017

PRODUCT RENEWED
as complying with the Florida
Building Code
NOA-No. 20-0128.05
Expiration Date 03/24/2025
By 
Miami-Dade Product Control

Contents:

Cover Page	Page 1
Product Details	Page 2
Performance/Installation	Page 3
Limitations/Reference Data	Page 4
Product Components	Page 5
Product Drawings & Details	Page 6-9

PRODUCT REVISED
as complying with the Florida
Building Code
NOA-No. 17-1211.14
Expiration Date 03/24/2020
By 
Miami-Dade Product Control

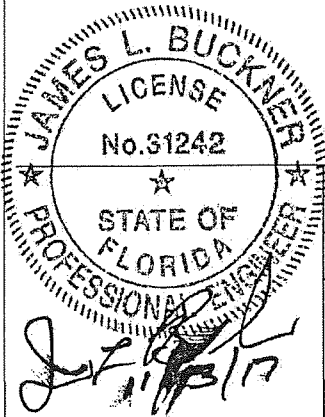

**BERRIDGE "HR-16" STEEL WALL & SOFFIT PANEL
ENGINEERING REPORT**

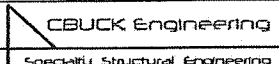
 Specialty Structural Engineering CBUGK, Inc. COA #8064 1374 Community Drive Jupiter, FL 33458 (561) 491-9927	MANUFACTURER: Berridge Manufacturing Company 6515 Fratt Rd. San Antonio, TX 78218	DATE:	11/13/2017
		PAGE #:	1 OF 9
		REPORT #:	17-128-HR16-ER
		REVISES #:	09-192-HR16-ER.3
		DRAWN BY:	DG
		REVISIONS:	(2/9/12),(4/16/15),(11/13/17)

1.0 Product:

- 1.1 **Manufacturer:** Berridge Manufacturing Company
- 1.2 **Product Name:** "HR-16" Structural Steel Wall & Soffit Panel
- 1.3 **Category:** Panels
- 1.4 **Subcategory:** Wall

2.0 Evaluation Scope:

2.1 Evaluation Criteria:

- 2.1.1 Florida Building Code (FBC) 6th Edition (2017)
 - 2.1.1.1 Code Section: High Velocity Hurricane Zone (HVHZ)
 - 2.1.1.2 Miami-Dade Department Of Regulatory And Economic Resources, Product Control Section Checklist # 0250

2.2 Properties Evaluated:

- 2.2.1 Wind Resistance Properties
 - 2.2.1.1 Uniform Static Air Pressure
(Structural only. This panel system has not been tested for water & air infiltration.)
 - 2.2.1.2 Cyclic Wind Pressure
 - 2.2.1.3 Large Missile Impact
- 2.2.2 Material Properties
 - 2.2.2.1 Tensile strength

PRODUCT RENEWED
 as complying with the Florida
 Building Code
 NOA-No. 20-0128.05
 Expiration Date 03/24/2025
 By [Signature]
 Miami-Dade Product Control

2.3 Limits of Evaluation:

This product is limited to compliance with the criteria in section 2.1 and properties in section 2.2 of this report.

PRODUCT REVISED
 as complying with the Florida
 Building Code
 NOA-No. 17-1211.14
 Expiration Date 03/24/2020
 By [Signature]
 Miami-Dade Product Control

3.0 Evaluated Uses:

"HR-16" Wall panels are evaluated for use as exterior wall or soffit panels.

4.0 Product Description:

4.1 General:

"HR-16" panels are structural steel wall panels with concealed fasteners, a flush seam appearance and an interlocking seam edge. Panels are installed horizontally to vertical steel supports with screws.

4.2 Product Dimensions:

- 4.2.1 Thickness: 24 gauge
- 4.2.2 Coverage Width: 16 in.
- 4.2.3 Rib height: 7/8 in.
- 4.2.4 Length: Roll formed, continuous up to 40 ft.

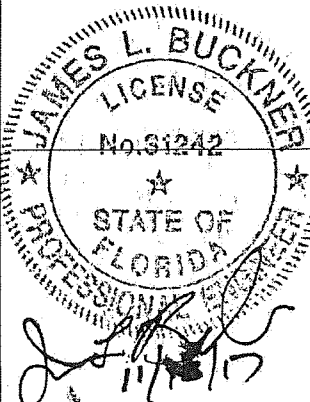

**BERRIDGE "HR-16" STEEL WALL & SOFFIT PANEL
 ENGINEERING REPORT**

CBUCK Engineering Specialty Structural Engineering CBUCK, Inc. COA #8064 1374 Community Drive Jupiter, FL 33458 (561) 491-9927	MANUFACTURER:	DATE:	11/13/2017
	Berridge Manufacturing Company	PAGE #:	2 OF 9
	6515 Fratt Rd.	REPORT #:	17-128-HR16-ER
	San Antonio, TX 78218	REVISES #:	09-192-HR16-ER.3
		DRAWN BY:	DG
		REVISIONS:	(2/9/12),(4/16/15),(11/13/17)

5.0 Support:

The Support assembly is designed by others and shall have the following minimum Characteristics:

- 5.1 Type: Girts
- 5.2 Material: Steel
- 5.3 Thickness: 16 Gauge min.
- 5.4 Yield Strength: 50 ksi
- 5.5 Girt Size: 2" min. flange bearing

6.0 Performance:

6.1 Wind Resistance:

Design Pressure: Positive + 65 psf
 Negative - 115 psf

Based on the following conditions:

6.1.1 Support:

- 6.1.1.1 Type: Vertical Girts
- 6.1.1.2 Shape: Cee
- 6.1.1.3 Dimensions: 4" x 2-1/2"
- 6.1.1.4 Material: Steel
- 6.1.1.5 Thickness: 16 Ga.
- 6.1.1.6 Yield Strength: 50 ksi
- 6.1.1.7 Spacing: 24" o.c.
- 6.1.1.8 Span Condition: 4 or more

6.1.2 Attachment of "HR-16" panel per Section 7.0

6.2 Uniform Static Air Infiltration:

Standard TAS 202
 Results: Per Section 6.1

6.3 Cyclic Wind Loading:

Standard: TAS 203
 Results: Passed

6.4 Impact Rating: Large Missile Impact

Standard: TAS 201
 Results: Passed

PRODUCT RENEWED
 as complying with the Florida Building Code
 NOA-No. **20-0128.05**
 Expiration Date **03/24/2025**
 By [Signature]
 Miami-Dade Product Control

PRODUCT REVISED
 as complying with the Florida Building Code
 NOA-No. **17-1211.14**
 Expiration Date **03/24/2020**
 By [Signature]
 Miami-Dade Product Control

7.0 Installation:

Install per the following:

"HR-16" wall panel to supports:

Two screws per Section 12.2.1, located at the horizontal joints to the vertical supports (every 24 in.) and at every panel end (every 16 in.) Fasteners shall penetrate the steel supports by 1/2 in. minimum.

See Drawings on pages 6 through 9 of this report. Refer to manufacturer's installation instructions as a supplemental guide for attachment.

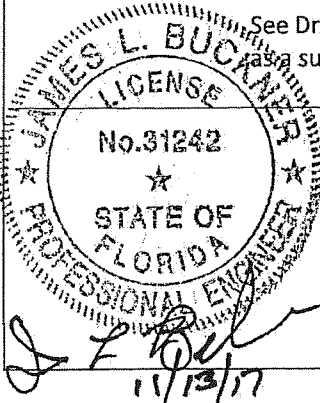

BERRIDGE "HR-16" STEEL WALL & SOFFIT PANEL ENGINEERING REPORT

CBUCK Engineering Specialty Structural Engineering CBUCK, Inc. COA #8064 1374 Community Drive Jupiter, FL 33458 (561) 491-9927	MANUFACTURER:	DATE:	11/13/2017
	Berridge Manufacturing Company	PAGE #:	3 OF 9
	6515 Fratt Rd.	REPORT #:	17-128-HR16-ER
	San Antonio, TX 78218	REVISES #:	09-192-HR16-ER.3
		DRAWN BY:	DG
		REVISIONS:	(2/9/12),(4/16/15),(11/13/17)

PRODUCT RENEWED
 as complying with the Florida
 Building Code
 NOA-No. 20-0128.05
 Expiration Date 03/24/2025
 By [Signature]
 Miami-Dade Product Control

8.0 Limitations of Use:

- 8.1 Performance data is based on minimum characteristics per Section 6.1.1.
- 8.2 Design of support system is outside the scope of this report. Support shall be structural framing members complying with the Miami-Dade (Florida High velocity zone) code and shall be designed by others.
- 8.3 Panel shall not be used as axial load bearing components and shall not be intended / designed to act as a diaphragm.
- 8.4 This evaluation is limited to the wall panel, wall panel fasteners and its attachment to the supports. The structural properties and design of all other items are outside the scope of this evaluation and should be submitted to the permitting jurisdiction for review and approval.

9.0 Code Compliance:

- 9.1 Product meets the High Velocity Hurricane Zone (HVHZ) Requirements of the Florida Building Code (FBC) 6th Edition (2017) for the properties evaluated.

10.0 Identification:

- 10.1 Each Panel shall bear a permanent one of the following permanent labels:

Berridge Manufacturing Co.	Berridge Manufacturing Co.	Berridge Manufacturing Co.
1720 Maury Street	6515 Fratt Road	2201 Rudeloff Road
Houston, TX 77026	San Antonio, TX 78218	Seguin, TX 78155

And the Statement: "Miami-Dade County Product Control Approved".

- 10.2 Labeling shall comply with FBC 6th Edition (2017), Section 1709.10.

PRODUCT REVISED
 as complying with the Florida
 Building Code
 NOA-No. 17-1211.14
 Expiration Date 03/24/2020
 By [Signature]
 Miami-Dade Product Control

11.0 Referenced Data:

- 11.1 Test Report on:
 TAS 201-94, Impact Test Procedures
 TAS 202-94, Criteria for Testing Impact and Non-impact Resistant Building Envelope Components Using Uniform Static Air Pressure
 TAS 203-94, Criteria for Testing Products Subject to Cyclic Wind Pressure Loading
 ASTM E8-08, Standard Test Methods for Tensile Testing of Metallic Materials
 For: "HR-16" Panel
 By: Architectural Testing, Inc., Southlake, TX
 Report No.: 78918-02-801-18, Dated: 8/20/09. Signed & Sealed 8/24/09 by Joseph A. Reed, P.E.

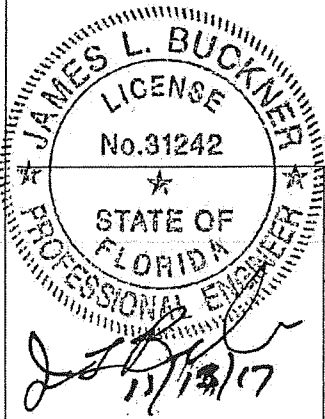

**BERRIDGE "HR-16" STEEL WALL & SOFFIT PANEL
 ENGINEERING REPORT**

CBUCK Engineering <small>Specialty Structural Engineering</small> CBUCK, Inc. COA #8064 1374 Community Drive Jupiter, FL 33458 (561) 491-9927	MANUFACTURER: Berridge Manufacturing Company 6515 Fratt Rd. San Antonio, TX 78218	DATE:	11/13/2017
		PAGE #:	4 OF 9
		REPORT #:	17-128-HR16-ER
		REVISES #:	09-192-HR16-ER.3
		DRAWN BY:	DG
		REVISIONS:	(2/9/12),(4/16/15),(11/13/17)

12.0 Product Components:

12.1 "HR-16" Panel:

12.1.1 Dimensions:

- 12.1.1.1 Panel Gauge: 24 gauge
- 12.1.1.2 Coverage Width: 16 in.
- 12.1.1.3 Rib height: 7/8 in.
- 12.1.1.4 Length: Roll formed, continuous up to 40 ft.

12.1.2 Properties:

- 12.1.2.1 Material: Steel
- 12.1.2.2 Yield Strength: 50 ksi
- 12.1.2.3 Thickness: 24 Gauge (t = 0.026" painted, as tested)
- 12.1.2.4 Corrosion Resistance/Standards:
 - 12.1.2.4.1 Galvanized G90 per ASTM A924
 - 12.1.2.4.2 Galvalume per ASTM A792 AZ 55 with Kynar 500

12.2 Fasteners:

12.2.1 Panel to Support Fasteners

- 12.2.1.1 Manufacturer: Generic
- 12.2.1.2 Type: Self Drilling Sheet Metal Screw
- 12.2.1.3 Size: #12 x 3/4"
- 12.2.1.4 Corrosion Resistance: Galvanized or Stainless Steel

PRODUCT RENEWED
 as complying with the Florida
 Building Code
 NOA-No. 20-0128.05
 Expiration Date 03/24/2025
 By [Signature]
 Miami-Dade Product Control

PRODUCT REVISED
 as complying with the Florida
 Building Code
 NOA-No. 17-1211.14
 Expiration Date 03/24/2020
 By [Signature]
 Miami-Dade Product Control

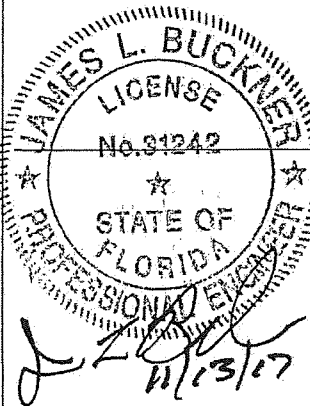

**BERRIDGE "HR-16" STEEL WALL & SOFFIT PANEL
 ENGINEERING REPORT**

CBUCK Engineering Specialty Structural Engineering CBUCK, Inc. COA #8064 1374 Community Drive Jupiter, FL 33458 (561) 491-9927	MANUFACTURER: Berridge Manufacturing Company 6515 Fratt Rd. San Antonio, TX 78218	DATE:	11/13/2017
		PAGE #:	5 OF 9
		REPORT #:	17-128-HR16-ER
		REVISES #:	09-192-HR16-ER.3
		DRAWN BY:	DG
		REVISIONS:	(2/9/12),(4/16/15),(11/13/17)

BERRIDGE MANUFACTURING COMPANY

"HR-16" DRAWINGS

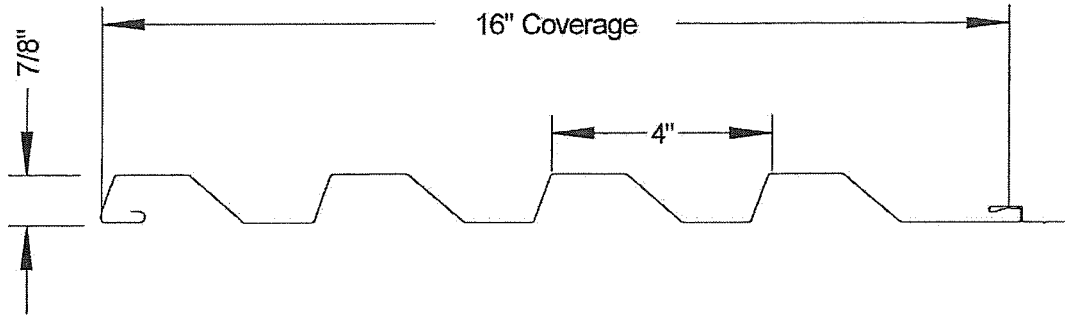

TYPICAL PANEL PROFILE

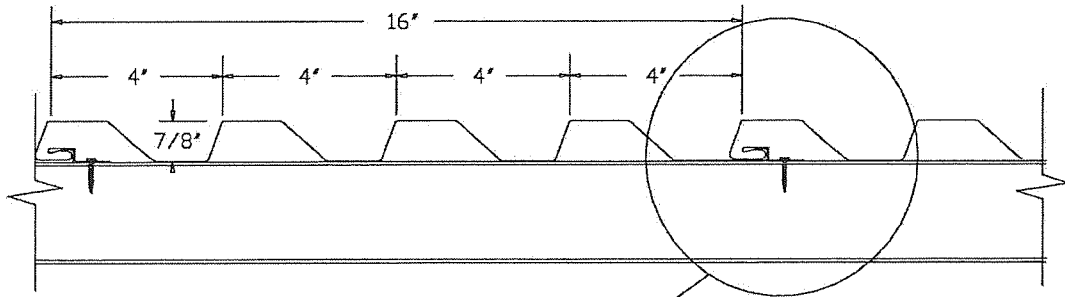

"HR-16"
Wall Panel

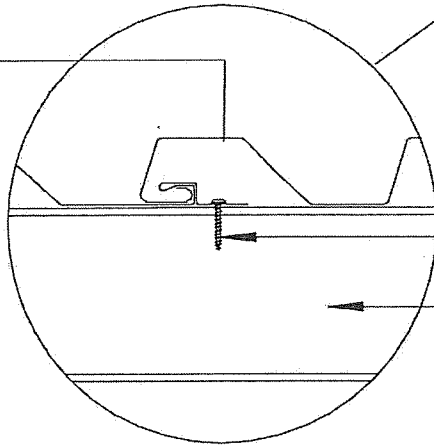

Two #12 X 3/4"
Self-Drilling Screws
Steel Support

**TYPICAL PANEL ASSEMBLY
SECTION VIEW**

PRODUCT RENEWED
as complying with the Florida
Building Code
NOA-No. 20-0128.05
Expiration Date 03/24/2025
By [Signature]
Miami-Dade Product Control

PRODUCT REVISED
as complying with the Florida
Building Code
NOA-No. 17-1211.14
Expiration Date 03/24/2020
By [Signature]
Miami-Dade Product Control

**BERRIDGE "HR-16" STEEL WALL & SOFFIT PANEL
PROFILE & TYPICAL ASSEMBLY SECTION VIEW**

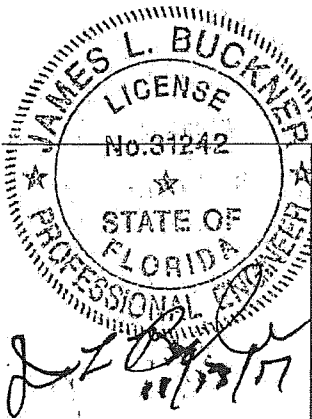

CBUCK Engineering Specialty Structural Engineering CBUCK, Inc. COA #8064 1374 Community Drive Jupiter, FL 33458 (561) 491-9927	MANUFACTURER: Berridge Manufacturing Company 6515 Fratt Rd. San Antonio, TX 78218	DATE:	11/13/2017
		PAGE #:	6 OF 9
		REPORT #:	17-128-HR16-ER
		REVISES #:	09-192-HR16-ER.3
		DRAWN BY:	DG
		REVISIONS:	(2/9/12),(4/16/15),(11/13/17)

BERRIDGE MANUFACTURING COMPANY

"HR-16" DRAWINGS

PRODUCT RENEWED
as complying with the Florida
Building Code

NOA-No. **20-0128.05**

Expiration Date **03/24/2025**

By *[Signature]*
Miami-Dade Product Control

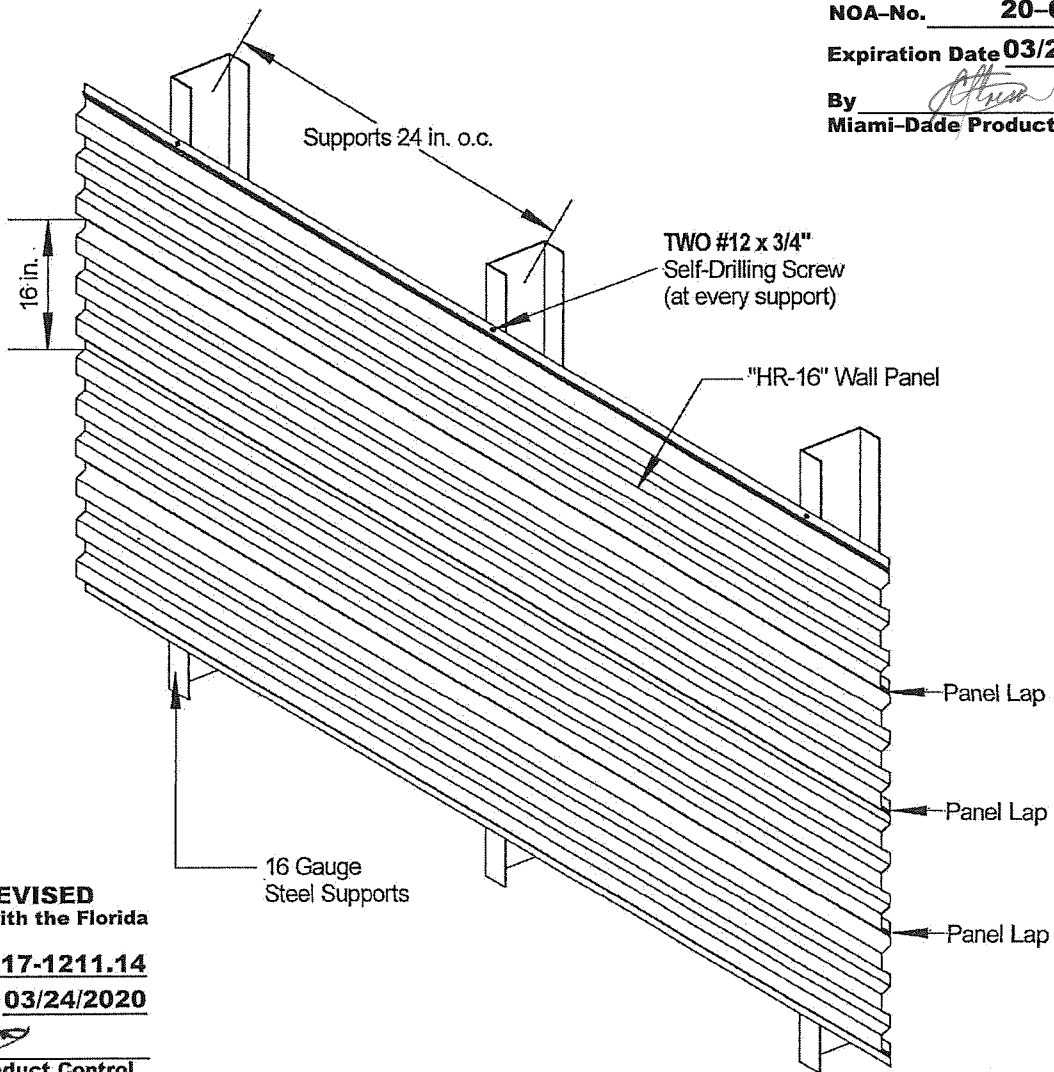

PRODUCT REVISED
as complying with the Florida
Building Code

NOA-No. **17-1211.14**

Expiration Date **03/24/2020**

By *[Signature]*
Miami-Dade Product Control

TYPICAL ELEVATION VIEW
OUTSIDE OF WALL ASSEMBLY

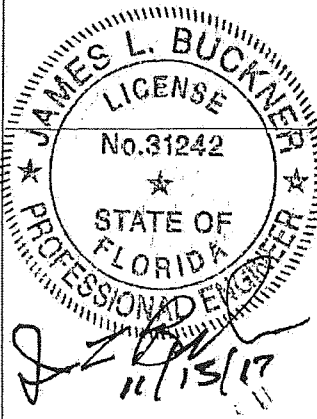

BERRIDGE "HR-16" STEEL WALL & SOFFIT PANEL
TYPICAL ELEVATION VIEW

CBUCK Engineering
Specialty Structural Engineering
CBUCK, Inc. COA #8064
1374 Community Drive
Jupiter, FL 33458
(561) 491-9927

MANUFACTURER:
Berridge Manufacturing
Company
6515 Fratt Rd.
San Antonio, TX 78218

DATE:	11/13/2017
PAGE #:	7 OF 9
REPORT #:	17-128-HR16-ER
REVISES #:	09-192-HR16-ER.3
DRAWN BY:	DG
REVISIONS:	(2/9/12),(4/16/15),(11/13/17)

BERRIDGE MANUFACTURING COMPANY

"HR-16" DRAWINGS

PRODUCT RENEWED
as complying with the Florida
Building Code

NOA-No. **20-0128.05**

Expiration Date **03/24/2025**

By *[Signature]*
Miami-Dade Product Control

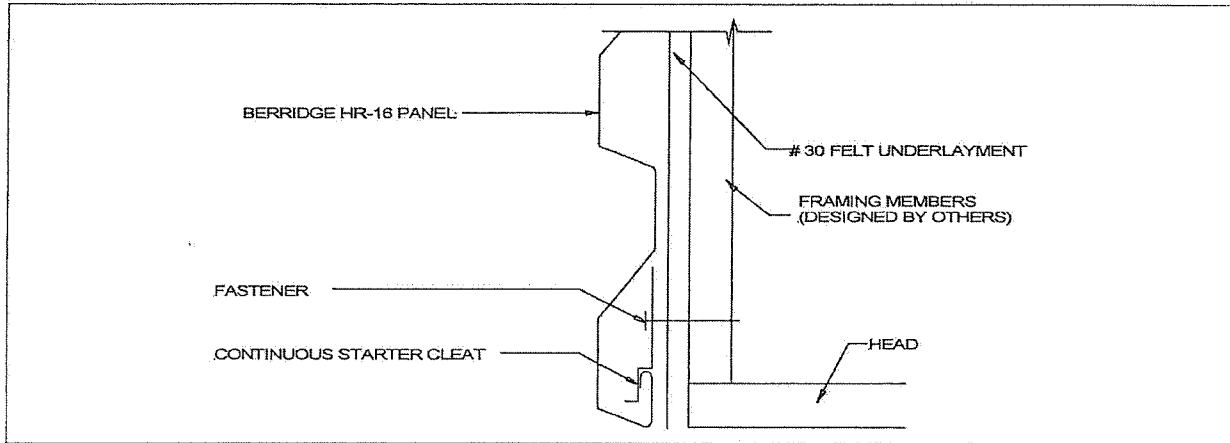

TYPICAL HEADER DETAIL

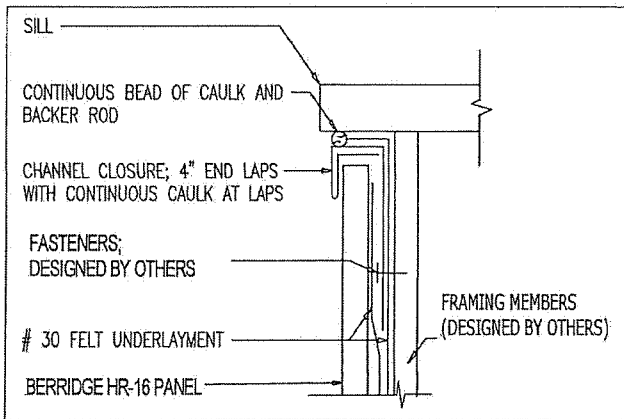

TYPICAL SILL DETAIL

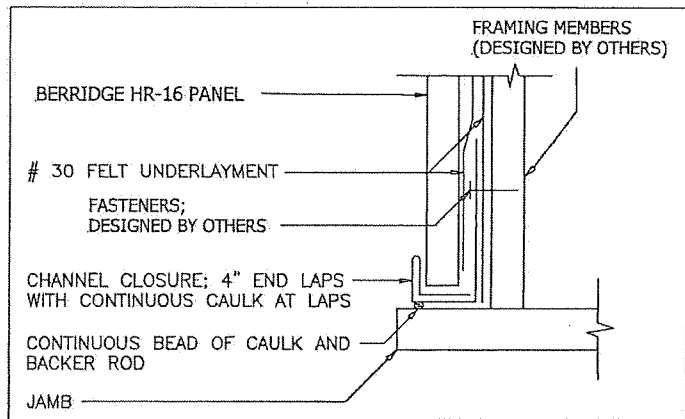

TYPICAL JAMB DETAIL

PRODUCT REVISED
as complying with the Florida
Building Code

NOA-No. **17-1211.14**

Expiration Date **03/24/2020**

By *[Signature]*
Miami-Dade Product Control

NOTES:

1. SUPPLEMENTAL ATTACHMENT DETAILS
DESIGNED BY OTHERS
2. REFER TO MANUFACTURER FOR FASTENER,
CAULKING SPECIFICATIONS &
SUPPLEMENTAL ATTACHMENT DETAILS

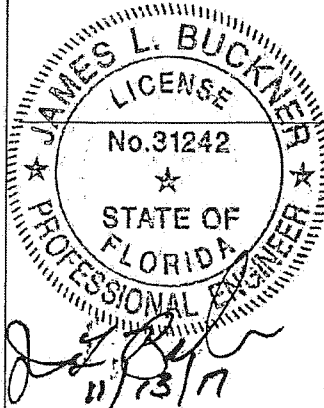

BERRIDGE "HR-16" STEEL WALL & SOFFIT PANEL (SUPPLEMENTAL DETAILS)
TYPICAL HEADER, SILL & JAMB DETAILS

CBUCK Engineering <i>Specialty Structural Engineering</i> CBUCK, Inc. COA #8064 1374 Community Drive Jupiter, FL 33458 (561) 491-9927	MANUFACTURER: Berridge Manufacturing Company 6515 Fratt Rd. San Antonio, TX 78218		DATE: 11/13/2017
			PAGE #: 8 OF 9
		REPORT #: 17-128-HR16-ER	REVISES #: 09-192-HR16-ER.3
		DRAWN BY: DG	REVISIONS: (2/9/12),(4/16/15),(11/13/17)

BERRIDGE MANUFACTURING COMPANY

"HR-16" DRAWINGS

PRODUCT RENEWED
as complying with the Florida
Building Code
NOA-No. **20-0128.05**

Expiration Date **03/24/2025**

By *[Signature]*
Miami-Dade Product Control

PRODUCT REVISED
as complying with the Florida
Building Code
NOA-No. **17-1211.14**
Expiration Date **03/24/2020**
By *[Signature]*
Miami-Dade Product Control

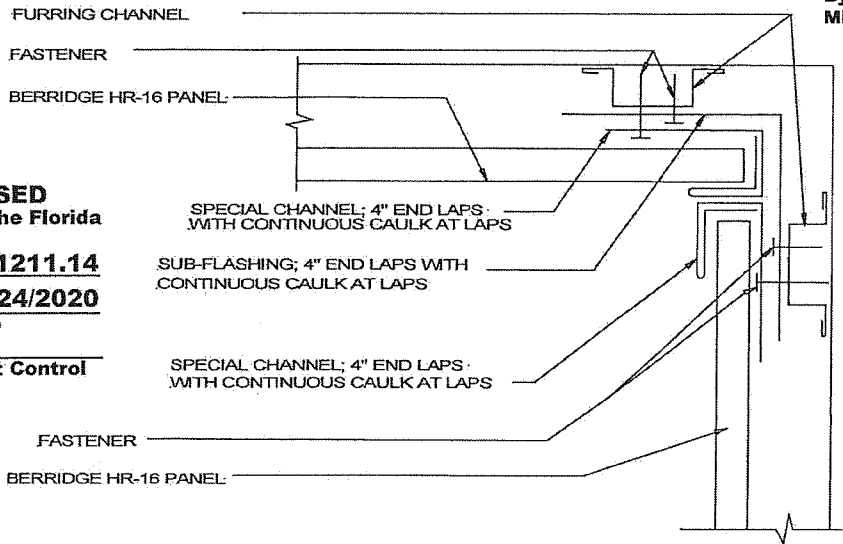

TYPICAL INSIDE CORNER DETAIL

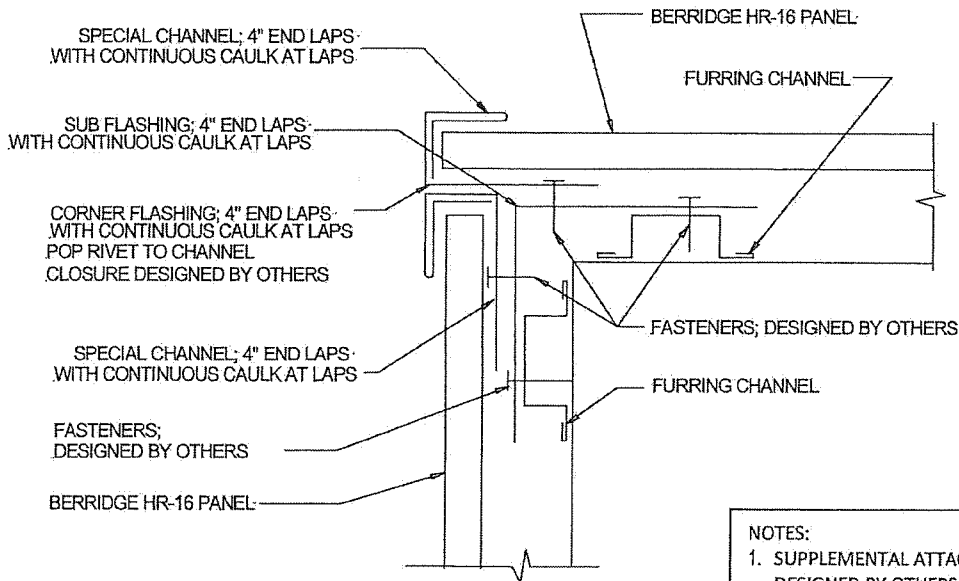

TYPICAL OUTSIDE CORNER DETAIL

NOTES:
1. SUPPLEMENTAL ATTACHMENT DETAILS
DESIGNED BY OTHERS
2. REFER TO MANUFACTURER FOR FASTENER,
CAULKING SPECIFICATIONS &
SUPPLEMENTAL ATTACHMENT DETAILS

**BERRIDGE "HR-16" STEEL WALL & SOFFIT PANEL (SUPPLEMENTAL DETAILS)
TYPICAL INSIDE & OUTSIDE CORNER DETAILS**

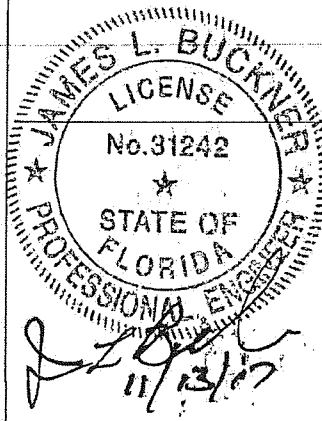

CBUCK Engineering
Society Structural Engineering
CBUCK, Inc. COA #8064
1374 Community Drive
Jupiter, FL 33458
(561) 491-9927

MANUFACTURER:
Berridge Manufacturing
Company
6515 Fratt Rd.
San Antonio, TX 78218

DATE:	11/13/2017
PAGE #:	9 OF 9
REPORT #:	17-128-HR16-ER
REVISES #:	09-192-HR16-ER.3
DRAWN BY:	DG
REVISIONS:	(2/9/12),(4/16/15),(11/13/17)