



**DEPARTMENT OF REGULATORY AND ECONOMIC RESOURCES (RER)
BOARD AND CODE ADMINISTRATION DIVISION
NOTICE OF ACCEPTANCE (NOA)**

**MIAMI-DADE COUNTY
PRODUCT CONTROL SECTION**
11805 SW 26 Street, Room 208
Miami, Florida 33175-2474
T (786) 315-2590 F (786) 315-2599
www.miamidade.gov/economy

**Clopay Corporation
8585 Duke Boulevard
Mason, OH 45040**

SCOPE: This NOA is being issued under the applicable rules and regulations governing the use of construction materials. The documentation submitted has been reviewed and accepted by Miami-Dade County RER-Product Control Section to be used in Miami-Dade County and other areas where allowed by the Authority Having Jurisdiction (AHJ). This NOA shall not be valid after the expiration date stated below. The Miami-Dade County Product Control Section (In Miami-Dade County) and/or the AHJ (in areas other than Miami-Dade County) reserve the right to have this product or material tested for quality assurance purposes. If this product or material fails to perform in the accepted manner, the manufacturer will incur the expense of such testing and the AHJ may immediately revoke, modify, or suspend the use of such product or material within their jurisdiction. RER reserves the right to revoke this acceptance, if it is determined by Miami-Dade County Product Control Section that this product or material fails to meet the requirements of the applicable building code.

This product is approved as described herein and has been designed to comply with the Florida Building Code, including the High Velocity Hurricane Zone.

DESCRIPTION: 2in. Steel Pan W7 DP41 Sectional Garage Door up to 18ft.-2in. Wide w/ Optional Impact Resistant Lites

APPROVAL DOCUMENT: Drawing No. **104762**, titled “2” Steel Pan Doors 18’-2”, sheets 1 through 3 of 3, dated 12/04/2012, with revision **04** dated 08/26/2020, prepared by Clopay Corporation, dated 09/10/2020, signed and sealed by Scott Hamilton, P.E., bearing the Miami-Dade County Product Control revision stamp with the Notice of Acceptance number and expiration date by the Miami-Dade County Product Control Section.

MISSILE IMPACT RATING: Large and Small Missile Impact Resistant

LABELING: A permanent label with the manufacturer’s name or logo, manufacturing address, model number, the positive and negative design pressure rating, indicate impact rated if applicable, installation instruction drawing reference number, approval number (NOA), the applicable test standards, and the statement reading ‘Miami-Dade County Product Control Approved’ is to be located on the door’s side track, bottom angle, or inner surface of a panel.

RENEWAL of this NOA shall be considered after a renewal application has been filed and there has been no change in the applicable building code negatively affecting the performance of this product.

TERMINATION of this NOA will occur after the expiration date or if there has been a revision or change in the materials, use, and/or manufacture of the product or process. Misuse of this NOA as an endorsement of any product, for sales, advertising or any other purposes shall automatically terminate this NOA. Failure to comply with any section of this NOA shall be cause for termination and removal of NOA.

ADVERTISEMENT: The NOA number preceded by the words Miami-Dade County, Florida, and followed by the expiration date may be displayed in advertising literature. If any portion of the NOA is displayed, then it shall be done in its entirety.

INSPECTION: A copy of this entire NOA shall be provided to the user by the manufacturer or its distributors and shall be available for inspection at the job site at the request of the Building Official.

This NOA **renews NOA # 17-1016.16** and consists of this page 1 and evidence pages E-1, E-2 and E-3, as well as approval document mentioned above.

The submitted documentation was reviewed by **Carlos M. Utrera, P.E.**



**NOA No 20-0922.18
Expiration Date: March 07, 2023
Approval Date: November 05, 2020
Page 1**

Clopay Corporation

NOTICE OF ACCEPTANCE: EVIDENCE SUBMITTED

1. EVIDENCE SUBMITTED UNDER PREVIOUS NOA's

A. DRAWINGS “Submitted under NOA # 15-0225.12”

1. Drawing No. **104762**, titled “2” Steel Pan Doors 18'-2”, sheets 1 through 3 of 3, 12/04/2012, with revision 02 dated 02/2015, prepared by Clopay Building Products Company, signed and sealed by Scott Hamilton, P.E.

B. TESTS “Submitted under NOA # 12-1213.06”

1. Test reports on 1) Uniform Static Air Pressure Test, Loading per FBC TAS 202-94
2) Large Missile Impact Test per FBC, TAS 201-94
3) Cyclic Wind Pressure Loading per FBC, TAS 203-94
4) Forced Entry Test, per FBC 2411 3.2.1, TAS 202-94
5) Tensile Test per ASTM E8
along with marked-up drawings and installation diagram of 18'-2”x 8', 24ga steel garage door Model 94W7 with windows, prepared by American Test Lab, Inc., Test Report No. **ATLNC 1107.01-12**, dated 11/20/2012, signed and sealed by David W. Johnson, P.E.
2. Test report on Salt Spray per ASTM B117 of painted G40 galvanized coated panels, prepared by Stork Materials Technology, Test Report No. **30160-04-63365**, dated 01/26/2005, signed by John D. Lee, P.E.

C. CALCULATIONS “Submitted under NOA # 12-1213.06”

1. Jamb anchor calculations prepared by Clopay Building Products Company, dated 12/03/2012, signed and sealed by Scott Hamilton, P.E.

D. QUALITY ASSURANCE

1. Miami-Dade Department of Regulatory and Economic Resources (RER)

E. MATERIAL CERTIFICATIONS

1. Notice of Acceptance No. **13-0717.01** issued to SABIC Innovative Plastics for their Lexan Polycarbonate Sheet Products, approved on 11/28/2013, expiring on 07/17/2018.

F. STATEMENTS “Submitted under NOA # 15-0225.12”

1. Statement letter of code conformance with the 2010 and the 5th edition (2014) FBC issued by Clopay Building Products Company, dated 02/18/2015, signed and sealed by Scott Hamilton, P.E.



Carlos M. Utrera, P.E.
Product Control Examiner NOA No
20-0922.18
Expiration Date: March 07, 2023
Approval Date: November 05, 2020

Clopay Corporation

NOTICE OF ACCEPTANCE: EVIDENCE SUBMITTED

F. STATEMENTS (CONTINUED)

2. Statement letters of code conformance to 2010 FBC and no financial interest, issued by Clopay Building Products Company, dated 12/03/2012, signed and sealed by Scott Hamilton, P.E. *“Submitted under NOA # 12-1213.06”*

2. EVIDENCE SUBMITTED UNDER PREVIOUS NOA # 17-1016.16

A. DRAWINGS

1. Drawing No. **104762**, titled “2” Steel Pan Doors 18’-2”, sheets 1 through 3 of 3, 12/04/2012, with revision **03** dated 7/2017, prepared by Clopay Building Products Company, signed and sealed by Scott Hamilton, P.E.

B. TESTS

1. None.

C. CALCULATIONS

1. None.

D. QUALITY ASSURANCE

1. Miami-Dade Department of Regulatory and Economic Resources (RER)

E. MATERIAL CERTIFICATIONS

1. Notice of Acceptance No. **15-0915.08** issued to SABIC Innovative Plastics, US LLC for their Lexan Polycarbonate Sheet Products, approved on 12/10/2015, expiring on 07/17/2018.

F. STATEMENTS

1. Statement letter of code conformance to **6th Edition (2017) FBC**, issued by Clopay Building Products Company, dated 10/04/2017, signed and sealed by Scott Hamilton, P.E.



Carlos M. Utrera, P.E.
Product Control Examiner NOA No
20-0922.18
Expiration Date: March 07, 2023
Approval Date: November 05, 2020

NOTICE OF ACCEPTANCE: EVIDENCE SUBMITTED

3. NEW EVIDENCE SUBMITTED

A. DRAWINGS

1. Drawing No. **104762**, titled “2” Steel Pan Doors 18’-2”, sheets 1 through 3 of 3, 12/04/2012, with revision **04** dated 08/26/2020, prepared by Clopay Corporation, dated 09/10/2020, signed and sealed by Scott Hamilton, P.E.

B. TESTS

1. None.

C. CALCULATIONS

1. None.

D. QUALITY ASSURANCE

1. Miami-Dade Department of Regulatory and Economic Resources (RER)

E. MATERIAL CERTIFICATIONS

1. None.

F. STATEMENTS

1. Statement letters of code conformance to **6th Edition (2017) and 7th Edition (2020) FBC**, issued by Clopay Corporation, dated 09/15/2020, signed and sealed by Scott Hamilton, P.E.
2. Certificate of amendment changing the company name from Clopay Building Products Company, Inc. to Clopay Corporation, issued by the State of Delaware, dated 08/27/2019.



Carlos M. Utrera, P.E.
Product Control Examiner
NOA No 20-0922.18
Expiration Date: March 07, 2023
Approval Date: November 05, 2020

MODELS	24 GA SHORT	24 GA FLUSH
CLOPAY	84A, 94	98
HOLMES	48, 48B	--
IDEAL	4RST	4F

SHEET:
1 OF 3

REVISIONS					
REV. NO.	ZONE:	DATE:	ECN NO.	APPVD:	DESCRIPTION
03	-	7/2017	-	SH	UPDATED CODE COMPLIANCE STATEMENT TO ADD 6TH EDITION FBC.
04	-	8/26/20	-	SH	UPDATED TITLE BLOCK AND CODE COMPLIANCE STATEMENT TO 7TH

ONE INTERMEDIATE STILE BETWEEN EACH EMBOSS LOCATION. ATTACHED W/ TOG-L-LOC (TOP & BTM) AND URETHANE ADHESIVE (ALONG CENTER).

OPTIONAL ROW OF IMPACT-RESISTANT GLAZING. MAX. GLAZING SIZE IS 18-1/2" x 11". GLAZING IS INJECTION MOLDED GE LEXAN SLX2432T, AN APPROVED CC2 PLASTIC IN ACCORDANCE WITH IBC/FBC 2606. SEE SECTION B-B FOR ASSEMBLY DETAILS. (GLAZING SHOWN IN INTERMEDIATE SECTION.)

IMPACT-RESISTANT CONSTRUCTION:
SOLID DOORS (NO GLAZING) OR DOORS WITH OPTIONAL IMPACT-RESISTANT GLAZING ARE IMPACT-RESISTANT. OPTIONAL INJECTION-MOLDED POLYCARBONATE FRONT FRAME AND GLAZING IS GE LEXAN SLX2432T, AN APPROVED CC2 PLASTIC IN ACCORDANCE WITH IBC/FBC 2606. THE ENTIRE DOOR ASSEMBLY INSTALLED IN COMPLIANCE WITH THIS SECTION MEETS THE WIND LOAD REQUIREMENTS OF THE FLORIDA BUILDING CODE AND INTERNATIONAL BUILDING CODE AND IS LARGE- AND SMALL-MISSILE IMPACT RESISTANT.

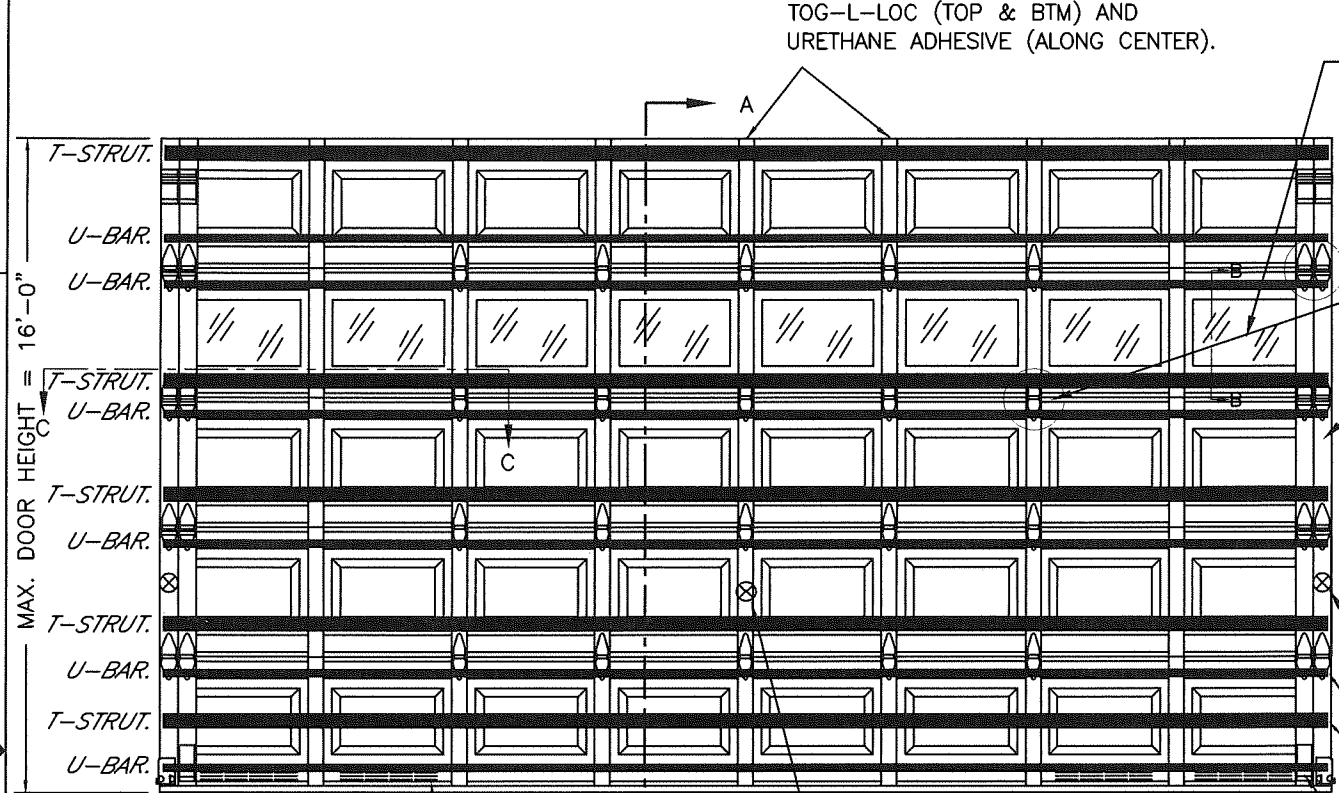

VIEW "B" (SEE SHEET TWO).

VIEW "C" (SEE SHEET TWO).

16 GA. END STILES ATTACHED TO DOOR SKIN WITH PATENTED TOG-L-LOC SYSTEM (TOP, BOTTOM & CENTER). ATTACHED TO TOP AND BOTTOM RAIL WITH PATENTED TOG-L-LOC SYSTEM.

TWO POINT LOCKING INTO TRACK.

U-BAR.

T-STRUT.

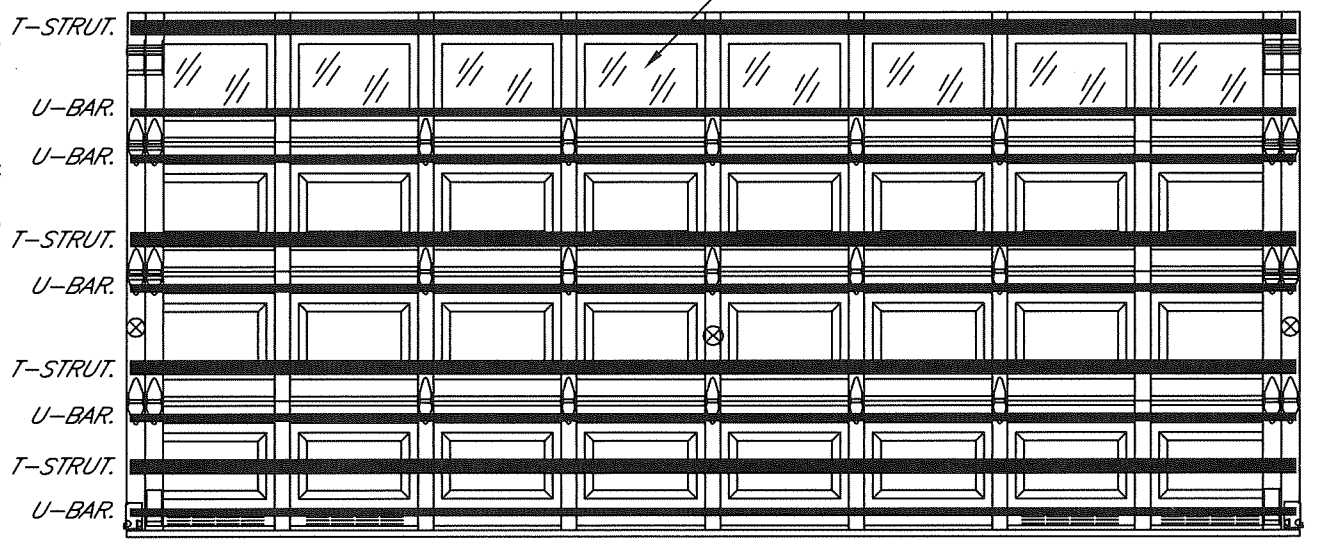

GLAZING SHOWN IN TOP SECTION.

MAX. DOOR HEIGHT = 16'-0"
MAX. DOOR WIDTH = 18'-2"
OPTIONAL OUTSIDE KEYED LOCK POSITION.

(1) 3-IN ROLLER CARRIER (P/N 0120394) USED WITH 3" TRACK.

DOOR HEIGHT	# OF SECTIONS
UP TO 7'0"	4
7'3" TO 8'9"	5
9'0" TO 10'6"	6
10'9" TO 12'3"	7
12'6" TO 14'0"	8
14'3" TO 15'9"	9
16'0"	10
MAX. SECTION HEIGHT: 21'	

LOCATION OF OPTIONAL VENTS. TOTAL VENT OPENINGS: 60 IN² PER VEHICLE.

SECTION B-B (IMPACT-RESISTANT GLAZING OPTION)

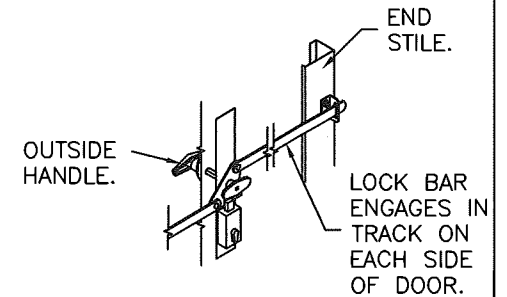
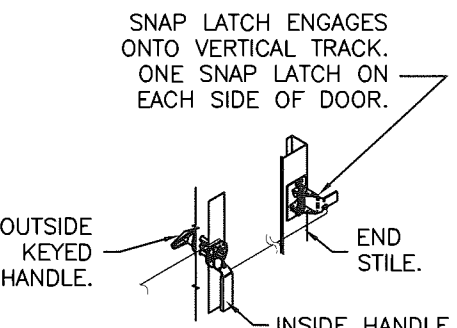
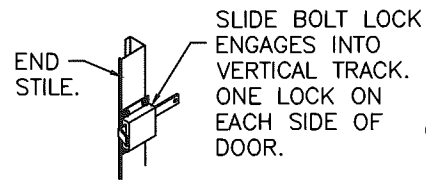
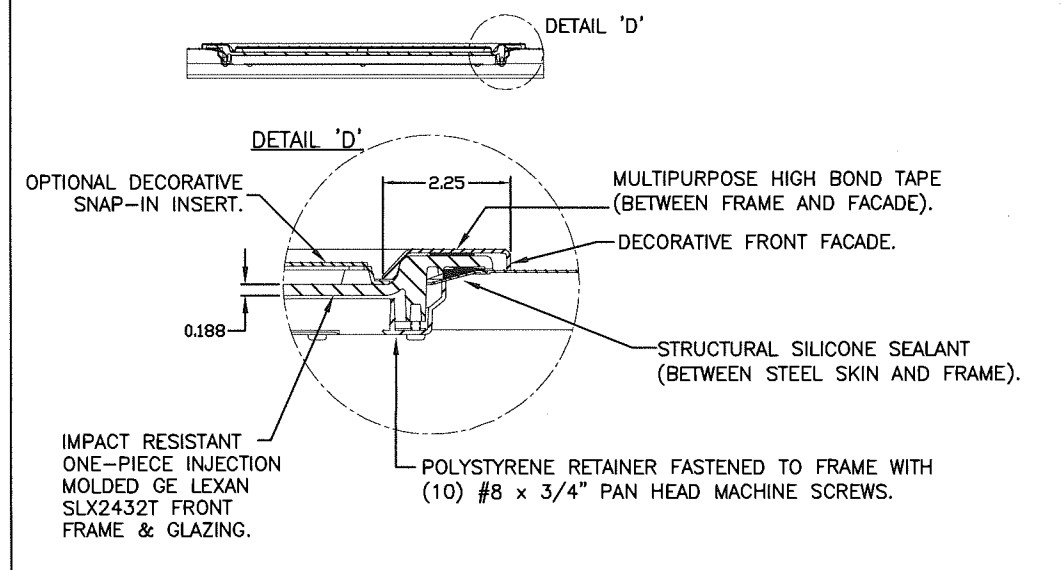

THIS PRODUCT CONFORMS TO THE REQUIREMENTS OF 6TH AND 7TH EDITION OF THE FLORIDA BUILDING CODE

DESIGN LOADS: +41.0 P.S.F. & -46.0 P.S.F.

Unless Stated Otherwise TOLERANCES are
.0 = ±.031
.00 = ±.015
.000 = ±.005
.0000 = ±.001
Degrees = ±1/2'

Clopay CORPORATION
8585 Duke Boulevard
Mason, OH 45040 USA
Tel. No. 513-770-4800
Fax No. 513-770-4853

PART NO.: N/A
WINDLOAD RATING
W7 DP41

DESCRIPTION: 2" STEEL PAN DOORS 18'2" (SEE TABLE FOR MODELS)			
DRAWN BY: SH	DATE: 12/3/12	SCALE: NTS	DWG. SIZE B
CHECKED BY: SH	DATE: 12/4/12	SHEET 1 OF 3	
DWG. NO.: 104762	VER: MD		

PRODUCT REVISED
as complying with the Florida Building Code
NOA-No. 20-0922.18
Expiration Date 03/07/2023
By *[Signature]*
Miami-Dade Product Control

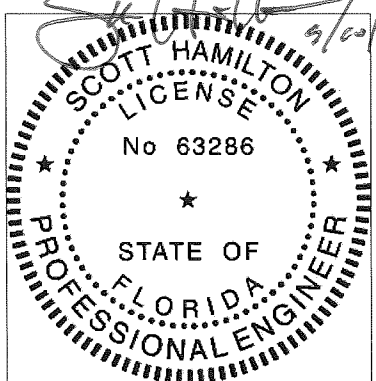

DESIGN ENGINEER:
SCOTT HAMILTON, P.E.
FLORIDA LICENSE No. 63286

MODELS	24 GA SHORT	24 GA FLUSH
CLOPAY	84A, 94	98
HOLMES	48, 48B	--
IDEAL	4RST	4F

SHEET: 2 OF 3		REVISIONS				
REV. NO.	ZONE:	DATE:	ECN NO.	APPVD:	DESCRIPTION	
04	-	-	-	-	SEE REVISION HISTORY ON SHEET ONE.	

JAMB TO SUPPORTING STRUCTURE ATTACHMENT

NOTES:

1. ALL THE LOAD FROM THE DOOR IS TRANSFERRED TO THE TRACK AND THEN FROM THE TRACK TO THE 2x6 VERTICAL SYP (GRADE #2 OR BETTER) JAMBS. NO LOAD FROM THE DOOR IS TRANSFERRED TO THE HORIZONTAL (TOP) JAMB.
2. EACH VERTICAL JAMB SEES A MAXIMUM DESIGN LOAD OF +369 LB & -414 LB. PER LINEAR FOOT OF JAMB.
3. ALL JAMB FASTENERS MAY BE (BUT ARE NOT REQUIRED TO BE) COUNTERSUNK TO PROVIDE A FLUSH MOUNTING SURFACE.
4. A 1/3 STRESS INCREASE FOR WIND LOAD WAS NOT USED IN THE CALCULATION OF ALLOWABLE LOADS FOR ANCHORS AND FASTENERS FOR STEEL, CONCRETE AND MASONRY.

WOOD FRAME BUILDINGS

STUD WALLS OF DOOR OPENING SHALL BE FRAMED SOLID BY NOT LESS THAN (3) 2x6 PRESSURE TREATED SYP (GRADE #2 OR BETTER) WOOD STUDS OF A STRESS GRADE NOT LESS THAN 1200 PSI NOMINAL EXTREME FIBER STRESS IN BENDING (F_b) FOR DOORS UP TO 8'0" HIGH OR (4) 2x6 PRESSURE TREATED SYP (GRADE #2 OR BETTER) WOOD STUDS OF A STRESS GRADE NOT LESS THAN 1200 PSI NOMINAL EXTREME FIBER STRESS IN BENDING (F_b) FOR DOORS UP TO 16'0" HIGH. STUD WALLS TO BE CONTINUOUS FROM FOOTING TO TIE BEAMS.

BLOCK WALL OR CONCRETE

2x6 SYP (GRADE #2 OR BETTER) WOOD JAMB SHALL BE ANCHORED TO GROUT REINFORCED BLOCK WALL OR CONCRETE COLUMN. BLOCK WALL CELLS SHALL BE FILLED WITH CONCRETE AND REINFORCED WITH REINFORCING BARS EXTENDING INTO THE FOOTING AND INTO TIE BEAMS. ALL BARS SHALL BE CONTINUOUS FROM THE TIE BEAMS TO FOOTING PER BLOCK WALL OR CONCRETE COLUMN. BLOCK WALLS AND CONCRETE COLUMNS TO BE DESIGNED BY THE BUILDING ENGINEER OR ARCHITECT OF RECORD AND IN ACCORDANCE WITH THE FLORIDA BUILDING CODE.

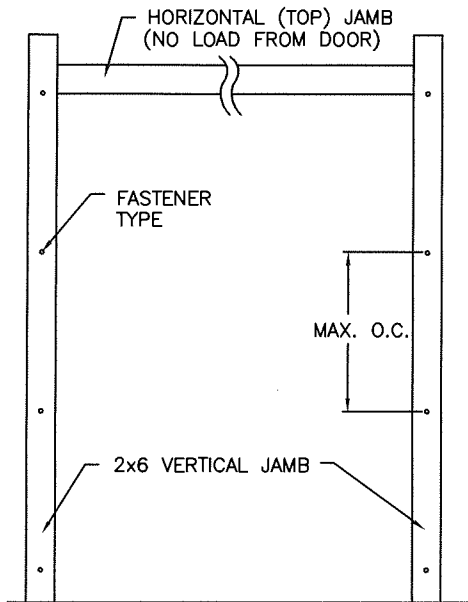

2x6 JAMB TO SUPPORTING STRUCTURE ATTACHMENT

(NOT TO BE USED FOR ATTACHMENT OF TRACK ANGLE TO 2x6 VERTICAL JAMBS OR SUPPORTING STRUCTURE)

BUILDING TYPE	FASTENER TYPE	MAXIMUM ON-CENTER DISTANCE BETWEEN FASTENERS*	STEEL WASHERS REQUIRED?
BLOCK WALL	1/4" x 1-1/4" MIN. EMBED TAPCON CONCRETE ANCHOR	6-1/4"	1" O.D.
3000 PSI MIN. CONCRETE	1/4" x 1" MIN. EMBED TAPCON CONCRETE ANCHOR	6-3/4"	1" O.D.
2000 PSI MIN. CONCRETE	3/8" x 1-3/4" MIN. EMBED WEJ-IT ANKR TITE SLEEVE ANCHOR	13-1/2"	INCLUDED
4000 PSI MIN. CONCRETE	3/8" x 1-3/4" MIN. EMBED WEJ-IT ANKR TITE SLEEVE ANCHOR	24"	INCLUDED
WOOD FRAME (SYP 0.55 SG)	1/2" x 3" LAG SCREW (ASTM A307, GRADE A) 1-5/8" EMBED INTO STRUCTURE	14-3/4"	1" O.D.

* FIRST (BOTTOM) ANCHOR STARTING AT NO MORE THAN HALF OF THE MAXIMUM ON-CENTER DISTANCE. HIGHEST ANCHOR INSTALLED AT LEAST AS HIGH AS THE DOOR OPENING.
CLOPAY DOES NOT SUPPLY JAMB ATTACHMENT FASTENERS.
MINIMUM DISTANCE BETWEEN CENTER OF ANCHOR AND EDGE OF CONCRETE BLOCK: 2-1/2", EXCLUDING STUCCO THICKNESS.

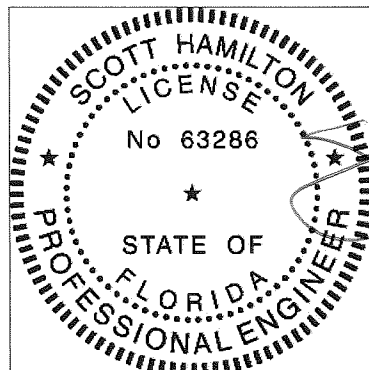

DESIGN ENGINEER:
SCOTT HAMILTON, P.E.
FLORIDA LICENSE No. 63286

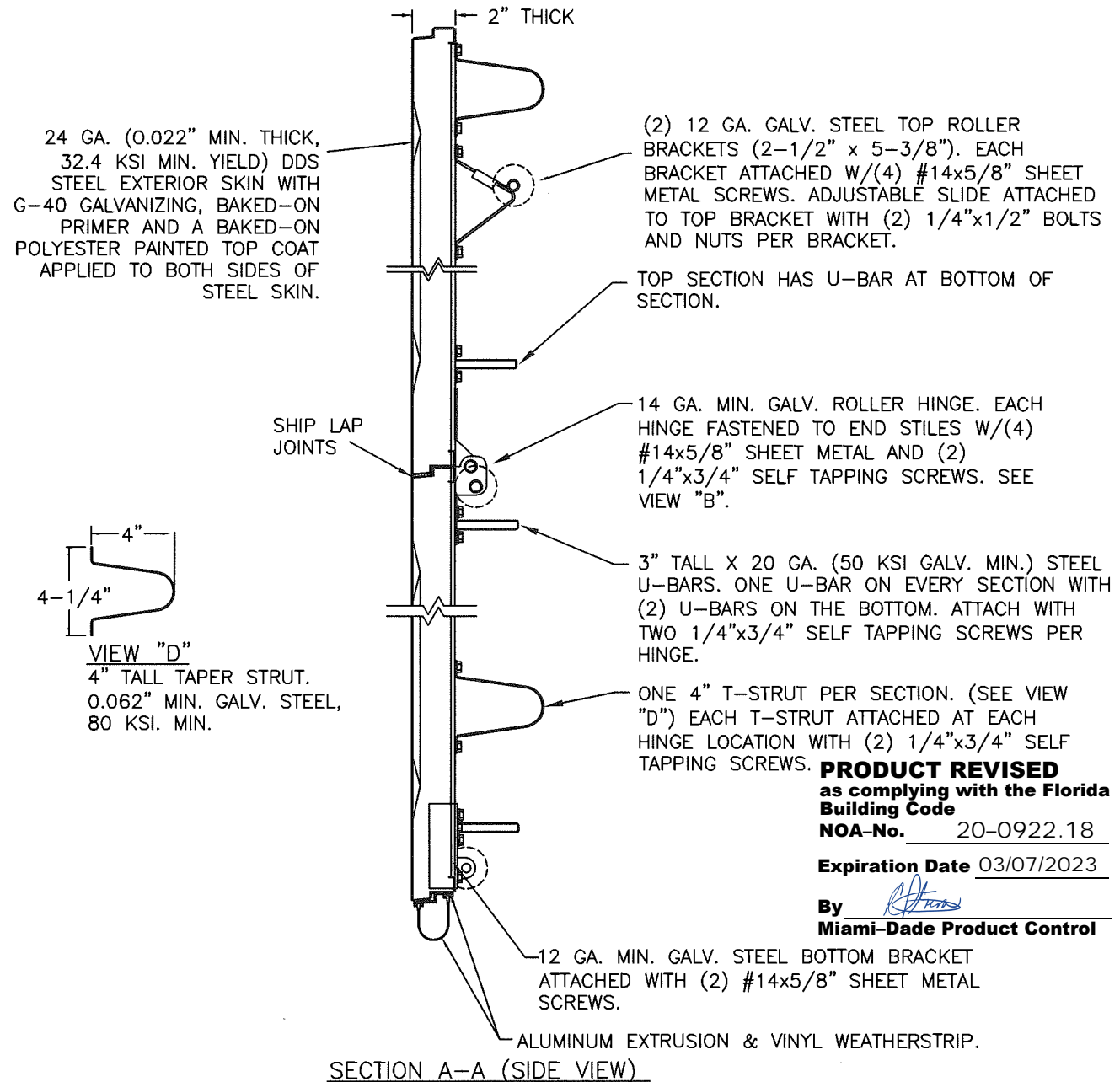
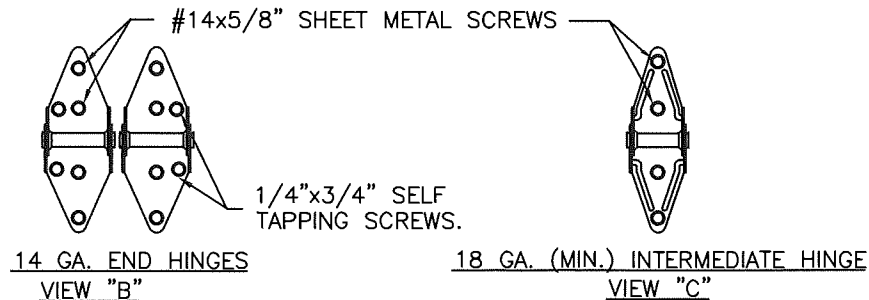

DESIGN LOADS: +41.0 P.S.F. & -46.0 P.S.F.

Unless Stated Otherwise TOLERANCES are

.0	= ±.031
.00	= ±.015
.000	= ±.005
.0000	= ±.001
Degrees	= ±1/2°

Unless Stated Otherwise DIMENSIONS ARE IN INCHES.



8585 Duke Boulevard
Mason, OH 45040 USA
Tel. No. 513-770-4800
Fax No. 513-770-4853

PART NO.: N/A	WINDLOAD RATING W7 DP41
DESCRIPTION: 2" STEEL PAN DOORS 18'2" (SEE TABLE FOR MODELS)	
DRAWN BY: SH	DATE: 12/3/12
CHECKED BY: SH	DATE: 12/4/12
DWG. NO.: 104762	VER: MD

PRODUCT REVISED
as complying with the Florida Building Code
NOA-No. 20-0922.18
Expiration Date 03/07/2023
By *[Signature]*
Miami-Dade Product Control

MODELS	24 GA SHORT	24 GA FLUSH
CLOPAY	84A, 94	98
HOLMES	48, 48B	--
IDEAL	4RST	4F

SHEET: 3 OF 3	REVISIONS					
	REV. NO.	ZONE:	DATE:	ECN NO.	APPVD:	DESCRIPTION
	04	-	-	-	-	SEE REVISION HISTORY ON SHEET ONE.

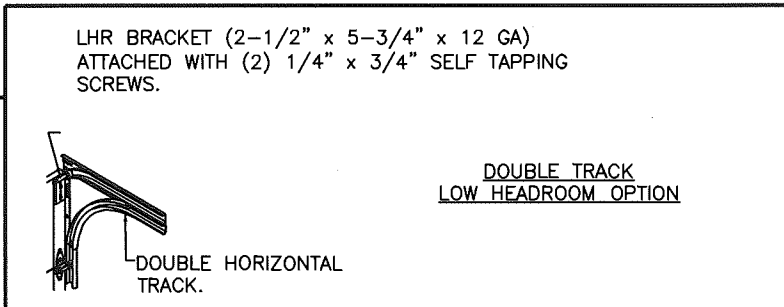

3" TRACK CONFIGURATION.

NOTE: TRACK CONFIGURATION ABOVE THE DOOR OPENING DOES NOT AFFECT THE WIND LOAD RATING OF THIS DOOR.

JAMB CONFIGURATION.

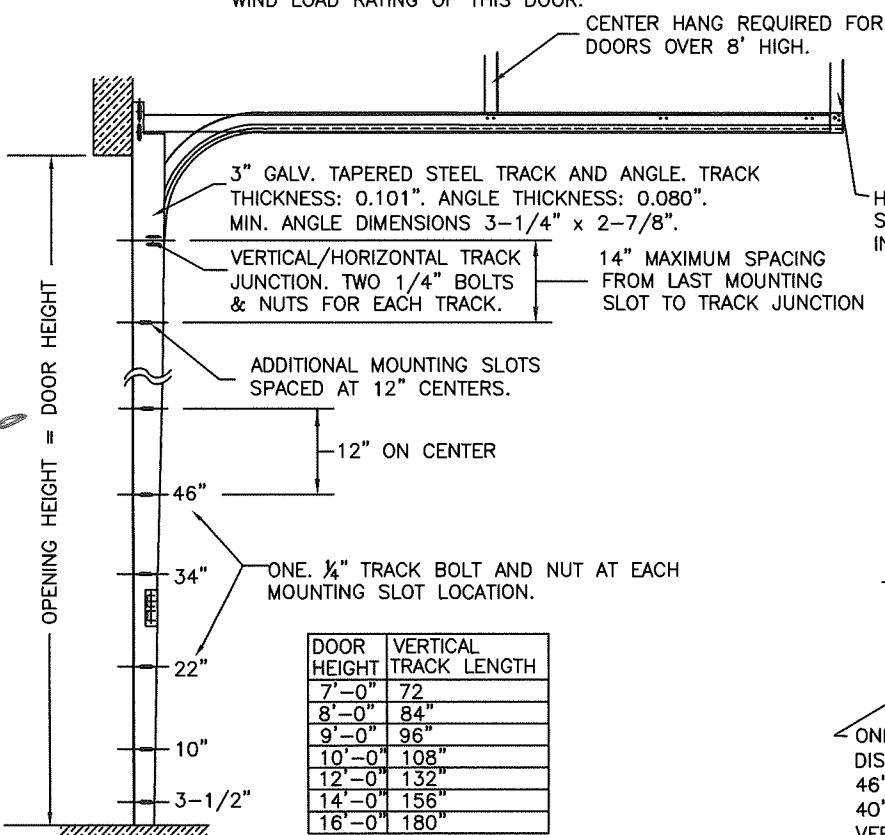

DOOR HEIGHT	VERTICAL TRACK LENGTH
7'-0"	72"
8'-0"	84"
9'-0"	96"
10'-0"	108"
12'-0"	132"
14'-0"	156"
16'-0"	180"

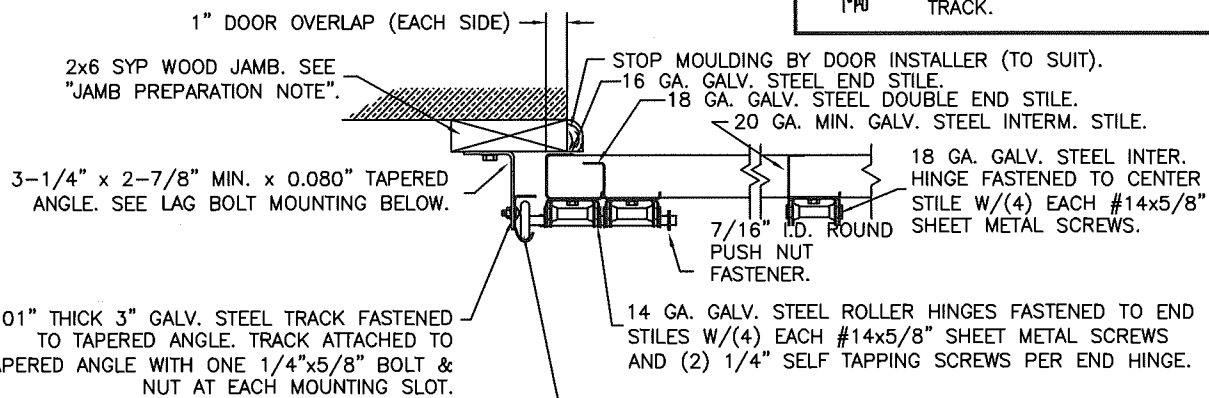

SECTION C-C

PREPARATION OF JAMBS BY OTHERS.

DESIGN LOADS: +41.0 P.S.F. & -46.0 P.S.F.

Unless Stated Otherwise
TOLERANCES are

.0 = ±.031
.00 = ±.015
.000 = ±.005
.0000 = ±.001
Degrees = ±1/2'

Unless Stated Otherwise
DIMENSIONS ARE IN INCHES.

Clopay
CORPORATION
8585 Duke Boulevard
Mason, OH 45040 USA
Tel. No. 513-770-4800
Fax No. 513-770-4853

PRODUCT REVISED
as complying with the Florida
Building Code
NOA-No. 20-0922.18

Expiration Date 03/07/2023

By Miami-Dade Product Control

PART NO.: N/A

WINDLOAD RATING
W7 DP41

DESCRIPTION: 2" STEEL PAN DOORS 18'2" (SEE TABLE FOR MODELS)

DRAWN BY: SH DATE: 12/3/12 SCALE: NTS DWG. SIZE B

CHECKED BY: SH DATE: 12/4/12 SHEET 3 OF 3

DWG. NO.: 104762 VER: MD

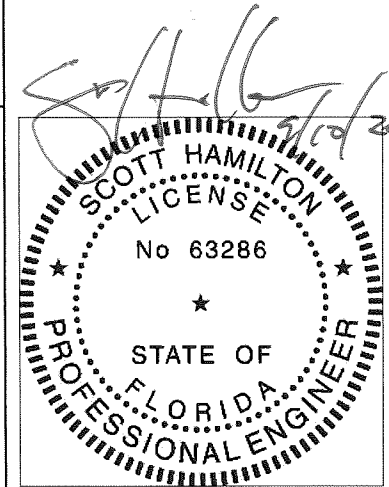

DESIGN ENGINEER:
SCOTT HAMILTON, P.E.
FLORIDA LICENSE No. 63286