

MEMORANDUM

Agenda Item No. 8(0)(1)

TO: Honorable Chairwoman Rebeca Sosa
and Members, Board of County Commissioners

DATE: May 21, 2013

FROM: R. A. Cuevas, Jr.
County Attorney

SUBJECT: Resolution approving and
authorizing execution of Consent
Decree between Miami-Dade
County, the United States of
America, State of Florida and
Florida Department of
Environmental Protection

The accompanying resolution was prepared by the Water and Sewer Department and placed on the agenda at the request of Co-Prime Sponsors Commissioner Audrey M. Edmonson and Commissioner Juan C. Zapata.





R. A. Cuevas, Jr.
County Attorney

RAC/jls

Date: May 21, 2013

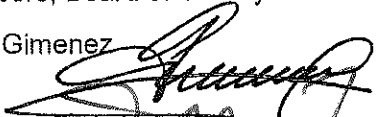
To: Honorable Chairwoman Rebeca Sosa
and Members, Board of County Commissioners

From: Carlos A. Gimenez
Mayor 
R. A. Cuevas, Jr.
County Attorney 

Subject: Resolution Authorizing the Execution of a New Consent Decree Between Miami-Dade County, the United States of America, the State of Florida and Florida Department of Environmental Protection

RECOMMENDATION

It is recommended that the Board of County Commissioners (Board) approve the attached resolution authorizing the execution of the attached Consent Decree between Miami-Dade County, the United States of America, the State of Florida and Florida Department of Environmental Protection, requiring the County to undertake and complete the Compliance Requirements specified in the new Consent Decree in order to comply with the Federal Clean Water Act and federal and state laws, regulations, and permits, with the goal of eliminating sanitary sewer overflows and prohibited bypasses. Approval of the Consent Decree by the Board will enable the parties to file the Consent Decree with the Court as the proposed resolution of all issues in the lawsuit. Project schedules commence when the Consent Decree is filed with the Court.

Upon Board approval, I, Mayor Carlos A. Gimenez, will effectuate this resolution by approving and filing it with the Clerk of the Board. This will allow the attached resolution to become effective immediately.

SCOPE

This item has county wide significance as it consists of repairing and rehabilitating sewer facilities throughout the County.

FISCAL IMPACT/FUNDING SOURCE

The fiscal impact to the County consists of the following estimated amounts over a 15-year period: (1) approximately \$1.6 billion in capital improvement expenditures to the sewer system that includes project management, design, permitting, procurement and construction of the capital improvements; (2) \$15 million for upgrading the Water and Sewer Department's (WASD) operations maintenance, management and reporting programs funded from WASD's operating revenues; (3) \$825,000.00 for outside monitoring of the new Consent Decree by the Florida Department of Environmental Protection paid from WASD's operating revenues; 4) a one-time civil penalty payment of \$978,100.00 paid from WASD's operating revenues and 5) approximately \$2 million over a five-year period for the cost of a supplemental environmental project paid from General Obligation Bonds (GOB).

TRACK RECORD/MONITOR

WASD's Deputy Director of Regulatory Compliance and Capital Improvements, Douglas Yoder, and Juan Carlos Arteaga, Assistant Director for Capital Improvements and Development will oversee the fulfillment of the new Consent Decree requirements.

BACKGROUND

On January 13, 1994, a First Partial Consent Decree was entered by the United States District Court for the Southern District of Florida to resolve claims involving compliance with the Clean Water Act that were brought by the United States against the County in Case Number 93:1109 CIV-Moreno. The First Partial Consent Decree required, among other things, construction of the 102-inch force main that conveys untreated sewage beneath Biscayne Bay from the mainland to the Central District Wastewater Treatment Plant. On September 12, 1995, a Second and Final Partial Consent Decree was entered into by the United States and the County to resolve all remaining issues in the case. The requirements of the First Partial Consent Decree and Second and Final Partial Consent Decree ("Existing Consent Decrees") focused on providing additional capacity in the sewer collection system to prevent capacity-related sewage overflows.

From Fiscal Year 1995 to Fiscal Year 2011, WASD has spent approximately \$1.8 billion upgrading its wastewater infrastructure and achieving significant progress in implementing and improving Capacity, Management, Operations and Maintenance Programs in order to comply with the requirements of the Existing Consent Decrees. As a result, the number and volume of capacity-related sewage overflows have been reduced. Specifically, there were no capacity-related overflows between 2002 and October 2011, even though the service area population increased and Hurricanes Rita, Wilma and Katrina struck South Florida.

However, in the past five years, a number of failures of aging pipelines have resulted in numerous sanitary sewer overflows. Additionally, the treatment standards have not been met on several occasions at the wastewater treatment plants due to equipment failures. Moreover, the Environmental Protection Agency conducted compliance evaluation inspections of the Central District Wastewater Treatment Plant and found several violations of the Clean Water Act Permit. Each of these violations is either a violation of the Clean Water Act or of the respective permit.

PROPOSED FEDERAL AND STATE ENFORCEMENT ACTION

In order to address these more recent compliance issues, on February 29, 2012, the United States, through the Environmental Protection Agency and the Department of Justice, presented the County with a draft proposal for a new Consent Decree and advised the County that a complaint would be filed against it in federal court. On December 13, 2012, the United States, the State of Florida and the Florida Department of Environmental Protection filed a complaint against the County for violations of the Clean Water Act and other federal and state laws, regulations and permits, Case Number 12-CV-24400-FAM.

WASD staff and representatives from the Department of Regulatory and Economic Resources (RER) and the County Attorney's Office have been engaged in extensive, good faith negotiations with representatives from the Environmental Protection Agency, the Department of Justice, and the Florida Department of Environmental Protection in order to establish the terms of the new Consent Decree to satisfy the complaint and address compliance issues. Updates regarding the progress and drafts of the new Consent Decree were sent to the Board on November 21, 2012 and on May 3, 2013 (copies of updates attached). The new Consent Decree will entirely replace and supersede the terms and provisions of the Existing Consent Decrees, which will both be terminated at the same time the new Consent Decree is approved by the Court. In light of the foregoing, the County

believes that the new Consent Decree is the best course of action. In the absence of an agreement, the United States and the Florida Department of Environmental Protection could seek a court order imposing more stringent requirements and timetables than those contained in the new Consent Decree.

THE NEW CONSENT DECREE

The requirements of the new Consent Decree include a number of operational and maintenance improvements in accordance with the Environmental Protection Agency's Capacity, Management, Operations and Maintenance Program guidelines that update existing WASD programs, such as operations and maintenance procedures and staffing, overflow response plans, spare parts inventories, information management systems, and financial assurance. The guidelines are attached to the Consent Decree in Appendix C. These requirements, known as deliverables, will involve submission of a series of plans and reports and the implementation of those plans.

The new Consent Decree also requires the Board to approve three ordinances following review and approval by the Environmental Protection Agency and Florida Department of Environmental Protection. The required ordinances are as follows:

The first ordinance is an amendment to Section 24-42.3 of the County Code to incorporate the criteria in Appendix A of the new Consent Decree relating to certification of sanitary sewer system collection, transmission and treatment capacity. This amendment will provide greater flexibility in managing capacity at pump stations and will support development. The WASD system has more than 1000 pump stations, more than any other sewer system in the continental United States. These stations convey sewage from the collection basins to the treatment plants. Under the Second and Final Partial Consent Decree and the Code of Miami-Dade County, whenever the pumps at a given station run for 10 hours or more per day averaged monthly over the course of a year, the pump station is considered to be "over capacity" and is placed in moratorium, so that no additional flows are permitted to be introduced into that collection basin until repairs or upgrades are completed. This restriction prevents new connections or even increased usage of existing connections. In basins where no actual overflows have occurred, the required amendment will allow approval of development projects, whether new connections or increased usage of an existing connection, that would result in small additional flows to the basin above the current limit of 10 hours while necessary upgrades to the pump station facilities are being made. These provisions will reduce the potential adverse impacts to Cities and the unincorporated areas under the current consent decree.

The second ordinance will amend Section 24-42.2 of the County Code as outlined in Appendix B to the new Consent Decree and applies the Capacity, Management, Operations and Maintenance Program requirements to "Volume Sewer Customers," which are municipal utilities served by WASD. The Volume Sewer Customers will be required to submit a Plan of Compliance that must include: a sewer overflow response plan; information management system program; sewer system asset management plan; gravity sewer system operation and maintenance program; pump station operations and preventative maintenance program; and force main operations, preventative maintenance and assessment/rehabilitative program. WASD and RER staff met with the Volume Sewer Customers in October of 2012 to discuss the requirements of the new Consent Decree that affect the Volume Sewer Customers and Appendix B.

The third ordinance is an amendment to the County's grease trap ordinance, Sections 24-15.3 and 24-18 of the County Code. The amendment will implement the requirements in Paragraph 19(a) of the new Consent Decree relating to the discharge of grease into the sewer systems. The ordinance will require, among other things, a characterization study to identify sources of fats, oil and grease that cause problems in the wastewater collection and transmission system and establish various standards including control device management, operations and maintenance standards that address onsite record keeping requirements, cleaning frequency and cleaning standards. The ordinance will also establish compliance inspection protocols and a fats, oil and grease disposal manifest system that prohibits commingling of fats, oil and grease with septic tank waste. The County will be responsible for enforcing each of these ordinances.

SYSTEM UPGRADES

The new Consent Decree includes a list of upgrades to the sewer collection system, pump stations, and treatment plants that are necessary to improve the reliability of the entire system as described in Appendix D of the new Consent Decree. These capital projects span a 15-year time frame, with initial emphasis on pipelines and pump stations. Work at the treatment plants must be carefully sequenced to ensure that sewage flows can be handled while the repairs are made. The total cost of these improvements is estimated to be about \$1.6 billion. The removal of a project identified in bold in Appendix D will require court approval. In September 2012, WASD held three public workshops to inform and receive input from the community and environmental justice groups regarding the capital improvement projects listed in Appendix D of the new Consent Decree.

IMPLEMENTATION

The County will need to retain consultants to assist in program management, planning, design, construction, and construction management of the capital improvement projects listed in Appendix D of the Consent Decree. These costs are typically 8 percent to 10 percent of construction costs and are included within the \$1.6 billion amount identified for capital improvements. This public/private partnership model has been very effective in the past for timely delivery of WASD's largest single capital project, the High Level Disinfection project at the South District Plant. To provide greater transparency in the implementation of the new Consent Decree, every document submitted to the Environmental Protection Agency and the Florida Department of Environmental Protection will be posted on WASD's website and kept in a public document repository. Additionally, any person may register with WASD to receive an electronic notice of the submissions.

FINANCING

The new Consent Decree includes required work that will have a clear financial impact on the system. The County agrees to fund each of the upgrades and programs required by the new Consent Decree. This is expected to require rate increases at various intervals beginning with an eight (8) percent water and sewer retail rate increase. Additionally, financing of the requirements of this Consent Decree will be achieved by a combination of WASD's Sewer Renewal and Replacement Fund, Building Better Communities General Obligation Bonds and WASD Revenue Bonds. The new Consent Decree requires a financial analysis program to effectively track the sufficiency of funds to implement the Compliance Requirements. Such program shall also track and report any transfer of sewer funds for any purpose not related to management, operation, maintenance or capital improvement of the sewer system. The County must provide thirty (30) days advanced written notice to the United States and the Florida Department of Environmental Protection of the intent to transfer such funds. However, such transfers to be tracked and reported do not apply to administrative reimbursements or funds internally used within WASD.

CIVIL PENALTIES

Following court approval of the new Consent Decree, the County shall pay a cash civil penalty of \$978,100.00 to be shared between the Department of Justice and the Florida Department of Environmental Protection.

SUPPLEMENTAL ENVIRONMENTAL PROJECT

In lieu of a higher cash civil penalty, the County will perform a supplemental environmental project that involves the installation of sewers in an industrial and commercial area within the Green Technology Corridor east of N.W. 37 Avenue and north of the Miami River. The amount of the project is approximately \$2 million and will be funded with Building Better Communities General Obligation Bonds designated for sewer projects. This project will reduce contamination potentially reaching the Miami River, and it will provide economic development opportunities in an area in great need of jobs. Since the subject area is designated as an Enterprise Zone, companies located within the Green Technology Corridor that employ at least 25 percent of their workforce from residents of the Enterprise Zone may be eligible to seek a refund of connection charges pursuant to Section 2-348 of the County Code.

COMPLIANCE MONITORING

Under an existing State Consent Order requiring the County to upgrade the South District Wastewater Treatment Plant to meet high level disinfection criteria, WASD is currently supporting a position at the Florida Department of Environmental Protection to monitor WASD's compliance with the terms of the agreement. Under the new Consent Decree, WASD will continue to support a position at the Florida Department of Environmental Protection to monitor compliance with the new Consent Decree at a maximum rate of \$55,000.00 per year for a total of \$825,000.00 over a 15-year period.

After execution by the County, the United States, and the State of Florida, the new Consent Decree will be filed in Case Number 12-CV-24400-FAM for approval by the U.S. District Court for the Southern District of Florida. The approval process includes a 30-day public comment period. The Court will consider comments received during the comment period and the arguments of the Intervening environmental group in deciding whether to approve the new Consent Decree.

If the Board approves this action, the County will be obligated to comply with the new Consent Decree as set forth above. Following approval by the U.S. District Court, the Court will provide oversight of the new Consent Decree, and failure to comply with the terms could result in Court enforcement including sanctions and orders. Additionally, any sewage discharges will subject the County to stipulated penalties, which range from \$500.00 to \$10,000.00 depending on overflow volumes and when the overflows occur during the duration of the new Consent Decree. Additional civil penalties could be required by the Environmental Protection Agency and Florida Department of Environmental Protection for sewage discharges, depending on the nature and consequence of the violations. Stipulated penalties on a daily basis may also be assessed for failure to timely submit deliverables or to meet deadlines to complete rehabilitation projects.

Based upon the County's potential liability exposure, the cost of litigation, and settlements reached in similar consent decrees across the country, the terms and penalty amounts provide a reasonable basis for settlement.

Honorable Chairwoman Rebeca Sosa
and Members, Board of County Commissioners
Page 6

Therefore, it is in the best interest of Miami-Dade County to enter into this new Consent Decree, and it is respectfully requested that the attached resolution and the new Consent Decree with the United States, the State of Florida and the Florida Department of Environmental Protection be approved.

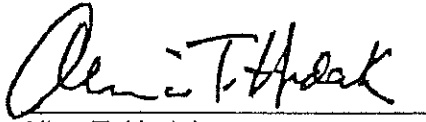
A handwritten signature in black ink, appearing to read "Alina T. Hudak", written over a horizontal line.

Alina T. Hudak
Deputy Mayor

Memorandum



Date: November 20, 2012

To: Honorable Chairman Joe A. Martinez and Members
Board of County Commissioners

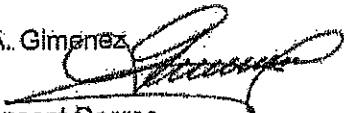
From: Carlos A. Gimenez
Mayor 

Subject: Draft Consent Decree

As you are aware, the Miami-Dade Water and Sewer Department (WASD) and the County Attorney's Office have been in negotiations with representatives of the United States Environmental Protection Agency, the United States Department of Justice, and the Florida Department of Environmental Protection to settle allegations of violations of the Clean Water Act as a result of the operation of the County's sewer system. Attached is the most recent draft of the consent decree by which this matter is proposed to be settled. We expect the final document to be provided by the Department of Justice soon, perhaps in time to be considered by the Board of County Commissioners at its December 4, 2012 meeting. A possible settlement agreement from myself and the County Attorney will summarize the key aspects of the consent decree as part of the agenda package, but due to the timing and significance of this issue, I want you to have the draft materials to review well in advance of any formal action.

Please feel free to contact me directly or John Renfrow, Director of WASD, at 786-552-8086 if you have any further questions.

Attachment

c: R. A. Cuevas, Jr., County Attorney
Allina T. Hudak, Deputy Mayor/County Manager
John Renfrow, Director, Water and Sewer Department
Jennifer Moon, Director, Office of Management and Budget

Memorandum



Date: May 3, 2013

To: Honorable Chairwoman Rebeca Sosa and Members
Board of County Commissioners

From: Carlos A. Gimenez
Mayor

Subject: Update Water and Sewer Consent Decree

A handwritten signature in black ink, appearing to read "Carlos A. Gimenez".

On November 21, 2012, I circulated to the Board of County Commissioners (BCC) a draft copy of a consent decree that was being negotiated by County staff, the U.S. Environmental Protection Agency (EPA), the U.S. Department of Justice (DOJ), and the Florida Department of Environmental Protection (DEP) to address alleged violations of the Clean Water Act that are caused by the County's operation of its sewer system. It was intended at the time for DOJ to simultaneously file a lawsuit and the agreed consent decree to address these alleged County violations of the Clean Water Act and other environmental regulations and permits. About that time, a local environmental organization provided notice that it intended to file a citizen suit against the County pursuant to the Clean Water Act. The organization did file its lawsuit, but it has since been dismissed in favor of the lawsuit filed by the DOJ.

On December 13, 2012, DOJ filed its lawsuit in federal court. The environmental organization has moved to intervene in that action in order to participate. A hearing on the motion to intervene is scheduled for May 14, 2013. Irrespective of any intervention, a consent decree between the County, the EPA, the DOJ, and the DEP has been finalized and an agenda item is being prepared to be submitted to the next available Board of County Commissioners (BCC) meeting. The final consent decree is attached for your review.

Approval of the consent decree by the BCC will enable the execution of the agreement and the parties to lodge the consent decree with the Court as the proposed resolution of all issues in the lawsuit. There will be a 30-day period for any person to provide comments to the DOJ Assistant Attorney General, Environment and Natural Resources Division. Any person, including the environmental organization that has placed us on notice, may state why the consent decree, as lodged, is either appropriate or inappropriate to address the violations alleged in the complaint. Although the Court will ultimately decide to either approve or disapprove the consent decree, certain obligations begin upon execution by the parties which would occur after approval by the BCC, but before it is lodged with the Court. Approval of the consent decree would avoid the time, cost, resources and risks of a trial. This approach to resolving Clean Water Act issues has been used extensively throughout the country. Failure to comply with the consent decree may result in stipulated penalties and sanctions by the Court.

The priority capital projects for restoring the reliability of the sewer plants and the collection system have not changed, totaling in cost about \$1.6 billion over a project period of 15 years. These are projects that are essential for the proper operation and maintenance of the sewer system and to otherwise comply with the environmental laws and permits.

As we have previously informed you, there are many water and sewer infrastructure needs beyond those identified in the consent decree. For that reason, you will soon be considering measures to increase Water and Sewer Department's (WASD) bonding capacity, increasing the reserve requirements for borrowing to stabilize and enhance WASD's bond rating, authorizing the initial bond sale to yield the first \$300 million to be applied to infrastructure requirements, and authorizing an overall increase in water and sewer rates of 8% beginning October 1, 2013, to finance the bond sale. The proposed rate increase is less than the 9% forecast that was included in the current year budget. Future year rate increases to support the capital program will be projected over a five year planning period as part of WASD's budget proposal.

Solicitations for program managers to operate as an extension of Department staff to execute the priority capital projects, pump station upgrades, and critical water main assessments have now been advertised so that we can initiate the necessary work on schedule. These solicitations are now under the Cone of Silence. Once selections have been made, solicitations for design contractors will be offered so that repairs and construction work can begin at the earliest possible time. Two of the priority projects are already well underway. The replacement of the 54 inch sewer line from Miami Beach to Virginia Key is proceeding on schedule. A new pipeline has been installed 100 feet below the water surface from Fisher Island to a point just off South Beach. A tunnel to enable the final connection of this line is under construction and the connection should be made in August of 2013, on schedule to facilitate the Port dredging project. The final phase of pipeline replacement from Fisher Island to Virginia Key will be a design/build project and is currently in the selection process. Also in process is the renewal and replacement of the 72 inch sewer line adjacent to the Biscayne Canal that is a primary feed to the North District Wastewater Treatment Plant. This is the line that failed in 2010, discharging an estimated 20 million gallons of wastewater into the canal.

Notwithstanding the ultimate outcome of the federal enforcement action and the consent decree, we must be proactive in addressing our water and sewer infrastructure needs. To that end, I have directed complete coordination among departments to ensure both speed and transparency in all aspects of the execution of WASD's infrastructure program, from planning through procurement and construction. This includes continuing attention to small and community business enterprises through all phases of the work, identification of opportunities for public/private partnerships, active involvement of the Inspector General's Office at the project level, and an emphasis on timely delivery of critical projects to support the economic recovery that has become increasingly evident. To assist in this effort, Mr. Juan Carlos Arteaga has joined the WASD senior management team, bringing his years of experience guiding the successful completion of the North Terminal project at the Airport. His insights will be invaluable as these critical projects unfold over the next several years. There may well be further opportunities to streamline our internal processes while maintaining the necessary levels of transparency and oversight so that we can complete this work as quickly as possible, thereby reducing the risks of a catastrophic failure and creating savings in the long run through effective asset management. This will require continued investment over the long term, not just to address an immediate crisis.

If you have any questions, please contact John W. Renfrow, P.E. at 786-552-8086 or me at 305-375-1880.

Attachment

c: R. A. Cuevas, Jr., County Attorney
Allina T. Hudak, Deputy Mayor
John W. Renfrow, Director, Water and Sewer Department
Jennifer Moon, Director, Office of Management and Budget



MEMORANDUM
(Revised)

TO: Honorable Chairwoman Rebeca Sosa
and Members, Board of County Commissioners

DATE: May 21, 2013

FROM: R. A. Cuevas, Jr.
County Attorney

SUBJECT: Agenda Item No. 8(0)(1)

Please note any items checked.

- "3-Day Rule" for committees applicable if raised
- 6 weeks required between first reading and public hearing
- 4 weeks notification to municipal officials required prior to public hearing
- Decreases revenues or increases expenditures without balancing budget
- Budget required
- Statement of fiscal impact required
- Ordinance creating a new board requires detailed County Mayor's report for public hearing
- No committee review
- Applicable legislation requires more than a majority vote (i.e., 2/3's ____, 3/5's ____, unanimous ____) to approve
- Current information regarding funding source, index code and available balance, and available capacity (if debt is contemplated) required

Approved _____ Mayor
Veto _____
Override _____

Agenda Item No. 8(0)(1)
5-21-13

RESOLUTION NO. _____

RESOLUTION APPROVING AND AUTHORIZING EXECUTION OF CONSENT DECREE BETWEEN MIAMI-DADE COUNTY, THE UNITED STATES OF AMERICA, STATE OF FLORIDA AND FLORIDA DEPARTMENT OF ENVIRONMENTAL PROTECTION; PROVIDING FOR SETTLEMENT OF ALLEGED VIOLATIONS OF FEDERAL AND STATE ENVIRONMENTAL LAWS RELATING TO THE COUNTY SEWAGE SYSTEM WITH AN ESTIMATED COST OF \$1.6 BILLION IN CAPITAL IMPROVEMENTS OVER A 15-YEAR PERIOD, \$15 MILLION FOR IMPLEMENTING MAINTENANCE AND MANAGEMENT PROGRAMS, \$2 MILLION FOR A SUPPLEMENTAL ENVIRONMENTAL PROJECT TO BE FUNDED IN WHOLE OR IN PART USING BUILDING BETTER COMMUNITIES GENERAL OBLIGATION BOND FUNDS, \$825,000.00 FOR MONITORING BY FLORIDA DEPARTMENT OF ENVIRONMENTAL PROTECTION AND \$978,100.00 FOR CIVIL PENALTY

WHEREAS, this Board desires to accomplish the purposes outlined in the accompanying memorandum, a copy of which is incorporated herein by reference,

NOW, THEREFORE, BE IT RESOLVED BY THE BOARD OF COUNTY COMMISSIONERS OF MIAMI-DADE COUNTY, FLORIDA, that this Board hereby approves the Consent Decree between Miami-Dade County, the United States of America, State of Florida and Florida Department of Environmental Protection for settlement of alleged violations of federal and state environmental laws related to the County's sewage system, with an estimated cost of \$1.6 billion in capital improvements over a 15-year period, \$15 million for implementing maintenance and management programs, \$2 million for a supplemental environmental project to be funded in whole or in part using Building Better Communities General Obligation Bond Funds, \$825,000.00 for monitoring by Florida Department of

Environmental Protection and payment of \$978,100.00 for a civil penalty; in substantially the form attached hereto and made a part hereof; and authorizes the Mayor and County Attorney to execute same for and on behalf of Miami-Dade County.

The foregoing resolution was offered by Commissioner , who moved its adoption. The motion was seconded by Commissioner and upon being put to a vote, the vote was as follows:

Rebeca Sosa, Chairwoman
Lynda Bell, Vice Chair

Bruno A. Barreiro
Jose "Pepe" Diaz
Sally A. Heyman
Jean Monestime
Sen. Javier D. Souto
Juan C. Zapata

Esteban L. Bovo, Jr.
Audrey M. Edmonson
Barbara J. Jordan
Dennis C. Moss
Xavier L. Suarez

The Chairperson thereupon declared the resolution duly passed and adopted this 21st day of May, 2013. This resolution shall become effective upon the earlier of (1) ten (10) days after the date of its adoption unless vetoed by the Mayor, and if vetoed, shall become effective only upon an override by this Board, or (2) approval by the County Mayor of this Resolution and the filing of this approval with the Clerk of the Board.

MIAMI-DADE COUNTY, FLORIDA
BY ITS BOARD OF
COUNTY COMMISSIONERS

HARVEY RUVIN, CLERK

By: _____
Deputy Clerk

Approved by County Attorney as
to form and legal sufficiency.



Henry N. Gillman

IN THE UNITED STATES DISTRICT COURT
FOR THE SOUTHERN DISTRICT OF FLORIDA

UNITED STATES OF AMERICA,)
the STATE OF FLORIDA DEPARTMENT)
OF ENVIRONMENTAL PROTECTION,)
and the STATE OF FLORIDA,)

Plaintiffs,)

v.)

MIAMI-DADE COUNTY,)
FLORIDA,)

Defendant.)
_____)

Case: No. 1:12-cv-24400-FAM

CONSENT DECREE

TABLE OF CONTENTS

I.	JURISDICTION AND VENUE	9
II.	APPLICABILITY	10
III.	OBJECTIVES	11
IV.	DEFINITIONS	12
V.	REVIEW, APPROVAL AND IMPLEMENTATION OF DELIVERABLES ...	18
VI.	COMPLIANCE REQUIREMENTS	22
17.	Obligation to Perform Work	22
18.	Continuation of Capacity, Management, Operations and Maintenance ("CMOM") Programs of the First Partial Consent Decree and Second and Final Partial Consent Decree	23
	(a). Adequate Pumping, Transmission and Treatment Capacity Program	23
	(b). Pump Station Remote Monitoring Program	24
	(c). WCTS Model	25
	(d). Spare Parts Program	28
	(e). Volume Sewer Customer Ordinance Program	28
19.	New CMOM Programs	31
	(a). Fats, Oils and Grease ("FOG") Control Program	31
	(b). Sewer Overflow Response Plan ("SORP")	34
	(c). Information Management System ("IMS") Program	38
	(d). Sewer System Asset Management Program	40
	(e). Gravity Sewer System Operations and Maintenance Program	41
	(f). Pump Station Operations and Preventative Maintenance Program	44
	(g). Force Main Operations, Preventative Maintenance and Assessment/Rehabilitation Program	47
	(h). WWTP Operations and Maintenance Program	53
	(i). Specific Capital Improvement Projects	57
	(j). Financial Analysis Program	58
VII.	CIVIL PENALTY	60
VIII.	SUPPLEMENTAL ENVIRONMENTAL PROJECT	62
IX.	REPORTING REQUIREMENTS	65

X.	STIPULATED PENALTIES.....	68
XI.	FORCE MAJEURE.....	75
XII.	DISPUTE RESOLUTION.....	77
XIII.	RIGHT OF ENTRY AND INFORMATION COLLECTION AND RETENTION.....	80
XIV.	NOT A PERMIT/COMPLIANCE WITH OTHER STATUTES/ REGULATIONS.....	82
XV.	EFFECT OF SETTLEMENT/RESERVATION OF RIGHTS.....	83
XVI.	COSTS.....	85
XVII.	NOTICES.....	85
XVIII.	DATE OF ENTRY.....	88
XIX.	RETENTION OF JURISDICTION.....	88
XX.	MODIFICATION.....	88
XXI.	TERMINATION.....	89
XXII.	PUBLIC PARTICIPATION.....	90
XXIII.	SIGNATORIES/SERVICE.....	90
XXIV.	INTEGRATION.....	91
XXV.	FINAL JUDGMENT.....	91
XXVI.	APPENDICES.....	91

WHEREAS, Plaintiff, the United States of America ("United States"), by the authority of the Attorney General of the United States and through its undersigned counsel, acting at the request and on behalf of the United States Environmental Protection Agency ("EPA"), filed a Complaint on December 13, 2012 alleging that the Defendant, Miami-Dade County, Florida ("Miami-Dade"), has violated and continues to violate Sections 301 of the Clean Water Act, 33 U.S.C. § 1311 ("CWA"), and the terms and conditions of its National Pollutant Discharge Elimination System ("NPDES") permits issued under Section 402 of the CWA, 33 U.S.C. § 1342;

WHEREAS, Plaintiff, the State of Florida Department of Environmental Protection ("FDEP"), joined in the Complaint and seeks injunctive relief and civil penalties for Miami-Dade's alleged violations of the Florida Air and Water Pollution Control Act, Chapter 403 of the Florida Statutes ("Fla. Stat.") and applicable rules of the Florida Administrative Code ("Fla. Admin. Code") promulgated thereto;

WHEREAS, FDEP has been authorized by EPA to administer the NPDES program in the State of Florida pursuant to Section 402(b) of the CWA, 33 U.S.C. § 1342(b);

WHEREAS, the State of Florida is a Plaintiff in this action, satisfying the requirements of Section 309(e) of the CWA, 33 U.S.C. § 1319(e), which requires the state in which a municipality is located to be joined as a party whenever a municipality is a party to a civil action brought by the United States under Section 309 of the CWA;

WHEREAS, Miami-Dade is a political subdivision of the State of Florida and a "municipality" pursuant to Section 502 of the CWA, 33 U.S.C. § 1362;

WHEREAS, Miami-Dade owns and operates a publically owned treatment works ("POTW") consisting of a municipal wastewater collection and transmission system ("WCTS"), which is designed to collect and convey municipal sewage (domestic, commercial and industrial), and three (3) municipal wastewater treatment plants: the North District Wastewater Treatment Plant ("North District WWTP"), the Central District Wastewater Treatment Plant ("Central District WWTP") and the South District Wastewater Treatment Plant ("South District WWTP");

WHEREAS, Miami-Dade's WCTS is a separate system from Miami-Dade's storm water conveyance system;

WHEREAS, Miami-Dade's POTW is one of the largest public utilities in the United States, providing both water and wastewater service to a population of over 2 million with 336,000 retail sewer accounts as well as fifteen (15) Volume Sewer Customers and numerous private collection systems; the POTW consists of three (3) regional WWTPs, 1,035 Pump Stations, roughly 910 miles of Force Main and approximately 3,071 miles of Gravity Sewer interceptors, Gravity Sewers and siphons; additionally, Miami-Dade is responsible for an estimated 2,241 miles of public laterals, for a total collection and transmission system of nearly 6,000 miles;

WHEREAS, the Volume Sewer Customers are responsible for collection and transmission systems totaling nearly 1,200 miles;

WHEREAS, Miami-Dade estimates that at least 10% of its Force Mains and Gravity Sewer interceptors are greater than fifty (50) years old, at least 42% are twenty-five (25) to fifty

(50) years old, at least 26% are less than twenty-five (25) years old, and 22% are of unknown age;

WHEREAS, the North District WWTP is regulated pursuant to NPDES Permit Number FL0032182, issued to Miami-Dade by FDEP pursuant to Section 402 of the CWA, 33 U.S.C. § 1342, Chapter 403 Fla. Stat. and applicable rules of the Fla. Admin. Code;

WHEREAS, the North District WWTP is also regulated pursuant to Florida Permit Number 0057792-009-UO, issued by FDEP to Miami-Dade pursuant to the Underground Injection Control requirements and regulations of the Safe Drinking Water Act, 42 U.S.C. § 300h, and Chapter 403 Fla. Stat. and applicable rules of the Fla. Admin. Code, as its treated wastewater is emplaced subsurface through well injection;

WHEREAS, the Central District WWTP is regulated pursuant to NPDES Permit Number FL0024805, issued to Miami-Dade by EPA pursuant to Section 402 of the CWA, 33 U.S.C. § 1342, as the ocean outfall for the Central District WWTP extends into federal waters;

WHEREAS, the Central District WWTP is also regulated pursuant to Florida Permit Number FLA024805, issued by FDEP to Miami-Dade pursuant to Chapter 403 Fla. Stat. and applicable rules of the Fla. Admin. Code;

WHEREAS, the South District WWTP is regulated pursuant to Permit Number FLA042137, issued by FDEP to Miami-Dade pursuant to Chapter 403 Fla. Stat. and applicable rules of the Fla. Admin. Code;

WHEREAS, the South District WWTP is also regulated pursuant to Florida Permit Numbers 61787-022-UO and 61787-023-UC, issued by FDEP to Miami-Dade pursuant to the Underground Injection Control requirements and regulations of the Safe Drinking Water Act, 42

U.S.C. § 300h, and Chapter 403 Fla. Stat. and applicable rules of the Fla. Admin. Code, as its treated wastewater is emplaced subsurface through well injection;

WHEREAS, on January 13, 1994, the United States District Court, Southern District of Florida, entered the First Partial Consent Decree resolving certain claims brought by the United States against Miami-Dade in a complaint pursuant to Section 504 of the CWA, 33 U.S.C. § 1364, concerning the alleged threat presented by Miami-Dade's continued use of the seventy-two (72) inch Force Main that conveyed untreated wastewater from the City of Miami under Biscayne Bay to the Central District WWTP;

WHEREAS, the First Partial Consent Decree required Miami-Dade to implement certain injunctive relief measures, including measures to address the alleged threat presented by Miami-Dade's continued use of the above-referenced seventy-two (72) inch Force Main;

WHEREAS, the State was identified in the First Partial Consent Decree as a statutory defendant pursuant to Section 309(e) of the CWA, 33 U.S.C. § 1319(e);

WHEREAS, on September 12, 1995, the United States District Court, Southern District of Florida, entered the Second and Final Partial Consent Decree resolving the outstanding claims brought by the United States against Miami-Dade in the complaint pursuant to Sections 301, 309(b) and (d), and 402 of the CWA, 33 U.S.C. §§ 1311, 1319(b) and (d), and 1342, alleging that the discharge of untreated wastewater from Miami-Dade's WCTS without a permit (also known as "Sanitary Sewer Overflows" or "SSOs") constitutes a violation of the CWA, the regulations promulgated thereunder, and the various terms and conditions of the NPDES Permits;

WHEREAS, the Second and Final Partial Consent Decree required Miami-Dade to implement certain injunctive relief measures to address the SSOs from Miami-Dade's WCTS;

WHEREAS, the State was identified in the Second and Final Partial Consent Decree as a statutory defendant pursuant to Section 309(e) of the CWA, 33 U.S.C. § 1319(e);

WHEREAS, since entry of the First Partial Consent Decree and the Second and Final Partial Consent Decree, Miami-Dade completed over 1,000 milestones and has successfully complied with and/or completed a substantial portion of the injunctive relief measures required by both the First Partial and Second and Final Partial Consent Decrees;

WHEREAS, Miami-Dade contends that from fiscal year 1995 to fiscal year 2011 it has spent approximately \$1.8 billion upgrading its wastewater infrastructure and achieving significant progress in implementing and improving Capacity, Management, Operations and Maintenance ("CMOM") programs in compliance with the requirements of various consent decrees and settlement agreements including, without limitation, the First Partial Consent Decree, the Second and Final Partial Consent Decree, and FDEP's Settlement Agreement System Wide and Settlement Agreement Cross Bay Line; and as a result, the number and volume of SSOs have been significantly reduced and with no capacity-related SSOs in the WCTS for the period from 2002 through October 2011 despite the increase in service area population and Hurricanes Wilma and Katrina;

WHEREAS, Miami-Dade contends that, as a result of the First Partial Consent Decree and the Second and Final Partial Consent Decree, it has implemented and continues to implement a \$300 million Pump Station Improvement Program ("PSIP") to upgrade the WCTS including Pump Stations and Force Mains pursuant to which each Pump Station had to be

certified as capable of meeting a nominal average pump operating time (“NAPOT”) of less than or equal to 10 hours per day; and Pump Stations exceeding the NAPOT criteria had to have a Remedial Action Plan and no building permits could be issued for connections to WCTS upstream of that station; and as a result, a total of 666 Remedial Action Plans were prepared and submitted to EPA through June 30, 2012, and a total of 664 Pump Stations and 222 Force Main projects have been completed;

WHEREAS, Miami-Dade contends that, as a result of the First Partial Consent Decree and the Second and Final Partial Consent Decree, it has implemented an Infiltration/Exfiltration/Inflow (“I/E/I”) Program to minimize the amount of groundwater infiltration, to redirect rainwater inflow from the sanitary sewers and to minimize potential leakage of raw sewage from defective sewers resulting in more than 32,000 mandated repairs being completed and, as of December 31, 2011 an estimated 127 million gallons per day (“mgd”) of I/I being removed from the WCTS;

WHEREAS, the First Partial Consent Decree and the Second and Final Partial Consent Decree mandated improvements in fats, oils and grease (“FOG”) control and volume customer control resulting in Miami-Dade adopting the following ordinances: (1) Grease Trap Ordinance, Sections 24-15 and 24-18 of the Code of Miami-Dade County, June 21, 1994; and (2) Volume Sewer Customer Ordinance, Section 24-42.2 of the Code of Miami-Dade County, November 12, 1997;

WHEREAS, the Parties recognize that since entry of the First Partial Consent Decree and the Second and Final Partial Consent Decree, conditions within and circumstances surrounding

Miami-Dade's WCTS and WWTPs have changed over the last eighteen (18) years, including, in particular, the causes and locations of SSOs;

WHEREAS, in April 2011, Miami-Dade conducted a CMOM Program self assessment to review its current programs to determine how these programs should be modified in order to more effectively address SSOs and improve system performance; and on May 1, 2011, Miami-Dade submitted to EPA a CMOM Report;

WHEREAS, as a result of such changed circumstances and conditions and the issues identified in Miami-Dade's self-assessment, the Parties recognize that appropriate modifications and updates to the required injunctive relief terms of both the First Partial Consent Decree and the Second and Final Partial Consent Decree are warranted;

WHEREAS, it is recognized that there are Volume Sewer Customers that own and operate their own wastewater collection and transmission systems that discharge into Miami-Dade's WCTS;

WHEREAS, the Parties intend for the terms and conditions of this Consent Decree to replace and supersede in their entirety the terms and provisions of both the First Partial Consent Decree and the Second and Final Partial Consent Decree, and the Parties request that the Court terminate both the First Partial Consent Decree and the Second and Final Partial Consent Decree upon entry of this Consent Decree;

WHEREAS, Miami-Dade has reported to EPA and FDEP within the last five (5) years numerous SSOs from its WCTS, including a number of large volume SSOs from ruptured Force Mains;

WHEREAS, Miami-Dade has also reported to EPA and FDEP within the last five (5) years a number of exceedances of the effluent limitations in the NPDES Permits;

WHEREAS, EPA and FDEP have inspected Miami-Dade's WCTS and WWTPs and have discovered a number of improper management, operations, and maintenance practices;

WHEREAS, the United States and FDEP contend that these SSOs; effluent limit exceedances; and improper management, operation, and maintenance practices are violations of the CWA, Fla. Stat., Fla. Admin. Code, and NPDES Permits;

WHEREAS, Miami-Dade has paid to FDEP civil penalties to settle notices of SSOs as follows: \$9,500.00 for a 2006 SSO as memorialized in Short Form Consent Order ("SFCO") No. 06-2308; \$8,500.00 for a 2006 SSO as memorialized in SFCO 06-2309; \$10,000.00 for a 2007 SSO as memorialized in SFCO 07-1185; \$7,500.00 for a 2007 SSO as memorialized in SFCO 07-1186; and \$10,000.00 for a 2010 SSO as memorialized in SFCO 08-0050;

WHEREAS, this Consent Decree requires Miami-Dade to develop, submit, finalize, and implement plans for the continued improvement of its WCTS and WWTPs to eliminate, reduce, prevent or otherwise control SSOs; to correct effluent limit violations; and to properly manage, operate and maintain its WCTS and WWTPs;

WHEREAS, the Parties acknowledge that, in 2008, the State of Florida enacted Chapter 2008-232, Laws of Florida which prohibits, in pertinent part, construction of new ocean outfalls and requires that all six (6) ocean outfalls in Florida cease using the outfalls as the primary means of wastewater disposal by December 31, 2025; and that wastewater facilities that discharged wastewater through an ocean outfall on July 1, 2008, are required to install a functioning reuse system (providing beneficial reuse of a significant percentage of the outfall

flow amounts) no later than December 31, 2025, and submit a detail implementation plan by July 1, 2013;

WHEREAS, the Parties acknowledge that the implementation of this legislation may impact the scope and scheduling of the capital improvements projects identified in Appendix D of this Consent Decree;

WHEREAS, the Parties to this Consent Decree have negotiated in good faith and have reached a settlement of the issues raised in the Complaint;

WHEREAS, Miami-Dade's agreement to this Consent Decree is not an admission of liability to the allegations arising out of transactions or occurrences alleged in the Complaint, and except for Miami-Dade's consent to jurisdiction and venue as provided in Section I of this Consent Decree (Jurisdiction and Venue), nor is it an adjudication or admission of any fact or law;

WHEREAS, the Parties recognize, and the Court by entering this Consent Decree finds, that this Consent Decree has been negotiated by the Parties in good faith and will avoid litigation between the Parties and that this Consent Decree is fair, reasonable, and in the public interest.

NOW THEREFORE, with the consent of the Parties, it is hereby ORDERED, ADJUDGED and DECREED as follows:

I. JURISDICTION AND VENUE

1. This Court has jurisdiction over the subject matter of this action, pursuant to 28 U.S.C. §§ 1331, 1345, and 1355, and Sections 309(b) and 504 of the CWA, 33 U.S.C. §§ 1319(b) and 1364, and over the Parties. This Court has supplemental jurisdiction over the state law claims asserted by FDEP pursuant to 28 U.S.C. § 1367. Venue is proper in the Southern

District of Florida pursuant to Section 309(b) of the CWA, 33 U.S.C. § 1319(b), and 28 U.S.C. §§ 1391(b) and 1395(a), because the violations alleged in the Complaint are alleged to have occurred in this judicial district. For purposes of this Consent Decree, or any action to enforce this Consent Decree, Miami-Dade consents to the Court's jurisdiction over this Consent Decree and any such action and over Miami-Dade and consents to venue in this judicial district.

2. For purposes of this Consent Decree, Miami-Dade agrees that the Complaint states claims upon which relief may be granted pursuant to Sections 309(b) and 504 of the CWA, 33 U.S.C. §§ 1319(b) and 1364; Fla. Stat. §§ 403.161, 403.141, 403.131 and 403.121.

II. APPLICABILITY

3. The obligations of this Consent Decree apply to and are binding upon the United States, EPA, the State, FDEP, and upon Miami-Dade and any successors, assigns, or other entities or persons otherwise bound by law.

4. No transfer of ownership or operation of any portion of the WCTS or of any WWTP, whether in compliance with the procedures of this Paragraph or otherwise, shall relieve Miami-Dade of its obligation to ensure that the terms of this Consent Decree are implemented. At least thirty (30) Days prior to such transfer, Miami-Dade shall provide a copy of this Consent Decree to the proposed transferee and shall simultaneously provide written notice of the prospective transfer, together with a copy of the proposed written agreement, to the United States and FDEP in accordance with Section XVII of this Consent Decree (Notices). Miami-Dade shall require, as a condition of any sale or transfer, that the purchaser or transferee agrees in writing to be bound by this Consent Decree and submit to the jurisdiction of the Court for its enforcement.

Any attempt to transfer ownership or operation of any portion of the WCTS or of any WWTP without complying with this Paragraph constitutes a violation of this Consent Decree.

5. Miami-Dade shall provide or otherwise make available a copy of this Consent Decree to all officers, employees, and agents whose duties might reasonably include compliance with any provision of this Consent Decree, as well as to any contractor retained to perform work required under this Consent Decree. Miami-Dade shall condition any such contract upon performance of the work in conformity with the terms of this Consent Decree.

6. In any action to enforce this Consent Decree, Miami-Dade shall not raise as a defense the failure by any of its officers, directors, employees, agents, or contractors to take any actions necessary to comply with the provisions of this Consent Decree.

III. OBJECTIVES

7. The express purpose of the Parties entering into this Consent Decree is for Miami-Dade to take all necessary measures, consistent with the objectives of the CWA, to achieve full compliance with the CWA, the regulations promulgated thereunder, Fla. Stat. Chapter 403, and the applicable Fla. Admin. Code Rules promulgated thereto, as well as the NPDES Permits, with the goal of eliminating all SSOs and Prohibited Bypasses. All plans, reports, construction, remedial maintenance, and other obligations in this Consent Decree, and under any amendment to this Consent Decree, shall have the objective of ensuring that Miami-Dade complies with the CWA, Fla. Stat. Chapter 403, all applicable federal and state regulations, and the terms and conditions of the NPDES Permits.

IV. DEFINITIONS

8. Terms used in this Consent Decree that are defined in the CWA or in regulations promulgated pursuant to the CWA shall have the meanings assigned to them in the CWA, 33 U.S.C. §§ 1251 *et seq.*, and regulations promulgated under the CWA, unless otherwise provided in this Consent Decree. Whenever the terms set forth below are used in this Consent Decree, the following definitions shall apply:

(a). "Building Backup" shall mean a wastewater release or backup into a building that is caused by blockages, flow conditions, or other malfunctions in Miami-Dade's WCTS. A wastewater backup or release that is caused by blockages, flow conditions, or other malfunctions of a Private Lateral is not a Building Backup.

(b). "Calendar Quarter" shall mean the three (3) Month periods ending on March 31, June 30, September 30, and December 31.

(c). "Calendar Year" shall mean the twelve (12) Month period starting on January 1 and ending on December 31.

(d). "Certification" or "Certify" when used in this Consent Decree shall require Miami-Dade to comply with Paragraph 16 of this Consent Decree.

(e). "CMOM" or "Capacity, Management, Operations, and Maintenance" shall mean a program of accepted industry practices to properly manage, operate and maintain sanitary wastewater collection, transmission and treatment systems, investigate capacity-constrained areas of these systems, and respond to SSO events.

(f). "Complaint" shall mean the complaint filed by the United States, the State, and FDEP in this action.

(g). "Consent Decree" shall mean this Consent Decree and all appendices attached hereto (listed in Section XXVI. (Appendices)). In the event of a conflict between this document and any appendix, this document shall control.

(h). "CWA" shall mean the Clean Water Act, as amended, 33 U.S.C. §§ 1251, *et seq.*

(i). "Date of Entry" shall have the definition provided in Section XVIII (Date of Entry).

(j). "Date of Lodging" shall mean the date this Consent Decree is filed for lodging with the Clerk of the Court for the United States District Court for the Southern District of Florida.

(k). "Day" shall mean a calendar day unless expressly stated to be a business day. In computing any period of time under this Consent Decree, where the last day would fall on a Saturday, Sunday, or federal holiday, the period shall run until the close of business of the next business day.

(l). "Defendant" shall mean Miami-Dade County, Florida and any successor thereto.

(m). "Deliverable" shall mean any written document required to be prepared and/or submitted by or on behalf of Miami-Dade pursuant to this Consent Decree.

(n). "DOJ" shall mean the United States Department of Justice.

(o). "EPA" shall mean the United States Environmental Protection Agency and any of its successor departments or agencies.

(p). "Effective Date" shall mean the Date of Entry or six (6) Months after the Date of Lodging, whichever occurs first.

(q). "FDEP" shall mean the State of Florida Department of Environmental Protection and any successor departments or agencies of the State.

(r). "Force Main" shall mean any pipe that receives and conveys, under pressure, wastewater from the discharge side of a pump. A Force Main is intended to convey wastewater under pressure.

(s). "Gravity Sewer Line" or "Gravity Sewer" shall mean a pipe that receives, contains and conveys wastewater not normally under pressure, but is intended to flow unassisted under the influence of gravity.

(t). "Infiltration" as defined by 40 C.F.R. § 35.2005(b)(20) shall mean water other than wastewater that enters the WCTS (including sewer service connections and foundation drains) from the ground through such means as defective pipes, pipe joints, connections, or manholes.

(u). "Inflow" as defined by 40 C.F.R. § 35.2005(b)(21) shall mean water other than wastewater that enters the WCTS (including sewer service connections) from sources such as, but not limited to, roof leaders, cellar drains, yard drains, area drains, drains from springs and swampy areas, manhole covers, cross connections between storm sewers and sanitary sewers, catch basins, cooling towers, storm water, surface runoff, street wash waters, or drainage.

(v). "I/I" shall mean the total quantity of water from Inflow, Infiltration, and rainfall-induced Inflow and Infiltration without distinguishing the source.

(w). "Miami-Dade" shall mean Miami-Dade County, Florida, including all of its departments, agencies, instrumentalities such as the Water and Sewer Department and the Department of Regulatory and Economic Resources, and any successor thereto.

(x). "Month" shall mean one (1) calendar month running from the numbered day to the same numbered day of the following calendar month, regardless of whether the particular month has 28, 29, 30 or 31 days. In the event a triggered event would occur on a day of the month which does not exist (for example, on February 30), then the event shall be due on the first day of the following month (for example, March 1).

(y). "NPDES" shall mean the National Pollutant Discharge Elimination System authorized under Section 402 of the CWA, 33 U.S.C. § 1342.

(z). "NPDES Permits" shall mean the most recently issued NPDES permits issued to Miami-Dade for its WWTPs.

(aa). "Ocean Outfall Legislation" shall mean the part of Chapter 2008-232, Laws of Florida, that has been codified in Fla. Stat. Section 403.086(9)(a)-(j).

(bb). "Paragraph" shall mean a portion of this Consent Decree identified by an Arabic numeral.

(cc). "Parties" shall mean the United States of America on behalf of EPA, the State of Florida, FDEP, and Miami-Dade.

(dd). "Plaintiffs" shall mean the United States of America on behalf of EPA, the State of Florida, and FDEP.

(ee). "Private Lateral" shall mean that portion of a sanitary sewer conveyance pipe that extends from a single-family, multi-family, apartment, or other dwelling unit or

commercial or industrial structure to which wastewater service is or has been provided up to the property line of such structure.

(ff). "Prohibited Bypass" shall mean the intentional diversion of waste streams from any portion of a treatment facility which is prohibited pursuant to the terms set forth at 40 C.F.R. § 122.41(m).

(gg). "Public Document Repository" or "PDR" shall mean the Miami-Dade Water and Sewer Department located at 3071 SW 38th Avenue and the Miami-Dade Water and Sewer Department's website, miamidade.gov/water.

(hh). "Pump Station" shall mean facilities comprised of pumps which pump wastewater to a higher hydraulic elevation, including all related electrical, mechanical, and structural systems necessary to the operation of that Pump Station.

(ii). "Sanitary Sewer Overflow" or "SSO" shall mean any discharge of wastewater to waters of the United States or the State from Miami-Dade's WCTS through a point source not permitted in any NPDES permit, as well as any overflow, spill, or release of wastewater to public or private property from the WCTS that may not have reached waters of the United States or the State, including all Building Backups.

(jj). "Section" shall mean a portion of this Consent Decree identified by a Roman numeral.

(kk). "Sewer System" shall mean the WCTS and the WWTPs.

(ll). "State" shall mean the State of Florida, including all of its departments, agencies, and instrumentalities.

(mm). "Subparagraph" shall mean a portion of a paragraph identified by a lowercase letter, a lowercase Roman numeral, or a capital letter.

(nn). "Timely" when applied to the submittal of a Deliverable shall mean submitted no later than the deadline established in this Consent Decree (or in a document approved pursuant to this Consent Decree) and containing all of the elements pertaining to the submittal as set forth in this Consent Decree (or in a document approved pursuant to this Consent Decree). "Timely," when applied to the implementation of any Work shall mean implemented no later than the deadline established in this Consent Decree (or in a document approved pursuant to this Consent Decree) and in accordance with the elements pertaining to such Work as set forth in this Consent Decree (or in a document approved pursuant to this Consent Decree).

(oo). "United States" shall mean the United States of America, acting on behalf of EPA, including its departments, agencies, and instrumentalities.

(pp). "Volume Sewer Customer" or "VSC" shall mean any entity or municipality serviced on a bulk basis (at a wholesale rate) by Miami-Dade within the territorial limits of Miami-Dade County, and currently includes the municipalities of Bal Harbour, Bay Harbor Islands, Coral Gables, Florida City, Homestead, Hialeah, Hialeah Gardens, Medley, Miami Beach, North Miami, Opa Locka, North Bay Village, North Miami Beach, Surfside and West Miami.

(qq). "Wastewater Collection and Transmission System" or "WCTS" shall mean the wastewater collection and transmission systems, including all pipes, Force Mains, Gravity Sewer Lines, Pump Stations, manholes and appurtenances thereto, owned or operated by

Miami-Dade designed to collect and convey municipal sewage (domestic, commercial and industrial) to Miami-Dade's WWTPs.

(rr). "Wastewater Treatment Plant" or "WWTP" shall mean devices or systems used in the storage, treatment, recycling, and reclamation of municipal wastewater. For purposes of this Consent Decree, this definition shall include all facilities owned, managed, operated, and maintained by Miami-Dade, including but not limited to the North District WWTP, the Central District WWTP, the South District WWTP, and all components of those plants.

(ss). "Work" shall mean all activities Miami-Dade is required to perform under this Consent Decree.

V. REVIEW, APPROVAL AND IMPLEMENTATION OF DELIVERABLES

9. Public Document Repository. No later than one business day from the submission of a Deliverable to EPA and FDEP pursuant to Sections VI (Compliance Requirements), VIII (Supplemental Environmental Project) and IX (Reporting Requirements) of this Consent Decree, Miami-Dade shall make available a copy of each Deliverable in the Public Document Repository ("PDR"). The Miami-Dade Water and Sewer Department office located at 3071 SW 38th Avenue and the Miami-Dade Water and Sewer Department's website, <http://www.miamidade.gov/water>, shall constitute the PDR. Miami-Dade shall bear the sole responsibility for depositing all Deliverables in the PDR. Additionally, Miami-Dade shall create a form on the Miami-Dade Water and Sewer Department's website that will allow any person or entity to register online to receive an electronic notice that a Deliverable is available in the PDR. Miami-Dade shall not be responsible for changes in electronic addresses. A registered person or entity shall not be a third-party beneficiary of this Agreement. Within seven (7) Days after

EPA's approval, approval upon conditions, or modification by EPA pursuant to this Section, if revised, Miami-Dade shall place a copy of such revised version of the Deliverable in the PDR. Every registered person or entity shall also receive an electronic notice that such revised version of the Deliverable is available in the PDR. Such copy shall replace all previous copies of that Deliverable in the PDR, and shall remain in the PDR until termination of this Consent Decree. In addition, Miami-Dade shall maintain in the PDR a listing of all Deliverables.

10. EPA Action on Deliverables. After review of any Deliverable that is required to be submitted pursuant to this Consent Decree, EPA, after consultation with FDEP, shall in writing: (a) approve the submission; (b) approve part of the submission and disapprove the remainder; or (c) disapprove the submission. If EPA approves only in part or disapproves entirely a submission pursuant to Subparagraphs 10(b) and (c) above, EPA shall provide a written explanation of how the submission is inconsistent with the applicable criteria set forth in the relevant Sections of this Consent Decree. EPA agrees to use best efforts to expeditiously review and comment on Deliverables. If EPA issues written comments and decisions on any Deliverable more than sixty (60) Days after receipt of such Deliverable, any subsequent deadline or milestone that is dependent upon such comments or decisions shall be extended. The length of the extension shall be determined by calculating the number of Days between EPA's receipt of the Deliverable and the date of Miami-Dade's receipt of EPA's written response, less sixty (60) Days. Within thirty (30) Days of the date that Miami-Dade knows or should know of a deadline or milestone that Miami-Dade believes is extended under this Paragraph, Miami-Dade shall inform EPA, in writing, of its belief and the amount of time Miami-Dade believes the deadlines or milestones are extended. If EPA disagrees with Miami-Dade's determination that a

deadline is dependent upon such comments or decisions, EPA shall inform Miami-Dade in writing. Miami-Dade may invoke Dispute Resolution pursuant to Section XII (Dispute Resolution) regarding EPA's conclusion regarding whether a deadline is dependent upon such comments or decisions.

11. Approved Deliverables. If a Deliverable is approved by EPA in its entirety pursuant to Subparagraph 10(a), Miami-Dade shall take all actions required by the Deliverable in accordance with the schedules and requirements of the Deliverable as approved. If the Deliverable is approved only in part pursuant to Subparagraph 10(b), Miami-Dade shall, upon written direction from EPA, after consultation by EPA with FDEP, take all actions required by the approved plan, report, or other item that EPA, after consultation by EPA with FDEP, determines are technically severable from any disapproved portions and not directly dependent upon an unapproved portion of the Deliverable, subject to Miami-Dade's right to dispute only the specified conditions or the disapproved portions, under Section XII of this Consent Decree (Dispute Resolution). Following EPA approval of any Deliverable or portion thereof, such Deliverable or portion thereof so approved shall be incorporated into and become enforceable under this Consent Decree, subject to Miami-Dade's right to dispute under Section XII of this Consent Decree (Dispute Resolution).

12. Disapproved Deliverables. If the Deliverable is disapproved in whole or in part pursuant to Subparagraph 10(b) or (c), Miami-Dade shall, within sixty (60) Days or such other time as EPA and Miami-Dade agree to in writing, correct all identified deficiencies and resubmit to EPA the Deliverable, or disapproved portion thereof, for approval, in accordance with Paragraphs 10 and 11, subject to Miami-Dade's right to dispute under Section XII of this

Consent Decree (Dispute Resolution). If the resubmission is approved in whole or in part by EPA, Miami-Dade shall proceed in accordance with Paragraph 11.

13. Stipulated Penalties Accruing. Any stipulated penalties applicable to the original Deliverable, as provided in Section X of this Consent Decree (Stipulated Penalties), shall accrue during the sixty (60)-Day period or other specified period, but shall not be payable unless the resubmitted Deliverable is not Timely or is disapproved in whole or in part; provided that, if the original submission was so deficient as to constitute a material breach of Miami-Dade's obligations under this Consent Decree, the stipulated penalties applicable to the original submission shall be due and payable notwithstanding any subsequent resubmissions.

14. Resubmitted Deliverable. If a resubmitted Deliverable, or portion thereof, is disapproved in whole or in part, EPA, after consultation with FDEP, may again require Miami-Dade to correct any deficiencies, in accordance with Paragraph 12, or may itself correct any deficiencies, subject to Miami-Dade's right to invoke Dispute Resolution under Section XII of this Consent Decree (Dispute Resolution) and the right of EPA to seek stipulated penalties as provided in preceding Paragraph 13. Upon correction of any deficiencies, such resubmitted Deliverable or portion thereof will be incorporated into and become enforceable under this Consent Decree and shall be implemented by Miami-Dade according to the approved schedule subject to Miami-Dade's right to invoke Dispute Resolution.

15. Revisions to Deliverables. The Parties recognize that Miami-Dade may need or want to revise certain Deliverables during the term of this Consent Decree. Any such revision shall be considered a non-material change to this Consent Decree for purposes of Section XX (Modification). Miami-Dade must obtain EPA's prior written approval, after EPA consults with

FDEP, of any revision to the substance of a Deliverable and shall place copies of any such revised Deliverable in the PDR and provide an electronic notice of such revised Deliverable to registered persons and entities in accordance with the provisions of Paragraph 9. Miami-Dade may revise the form of any Deliverable without consulting EPA or FDEP and shall place a copy of any such revised Deliverable in the PDR within seven (7) Days after making such revision.

16. Certification. In all Deliverables, notices, documents or reports submitted to the United States and FDEP pursuant to this Consent Decree, Miami-Dade shall, by a Miami-Dade senior management official, sign and certify such notices, documents and reports as follows:

I certify under penalty of law that this document and all attachments were prepared under my direction or supervision in accordance with a system designed to assure that qualified personnel properly gather and evaluate the information submitted. Based on my inquiry of the person or persons who manage the system, or those persons directly responsible for gathering such information, the information submitted is, to the best of my knowledge and belief, true, accurate and complete. I am aware that there are significant penalties for submitting false information, including the possibility of fine and imprisonment for knowing violations.

VI. COMPLIANCE REQUIREMENTS

17. Obligation to Perform Work. Upon the Effective Date of this Consent Decree, Miami-Dade shall implement the Work pursuant to this Consent Decree. Miami-Dade is responsible for ensuring that any contractors hired to perform Work pursuant to this Consent Decree comply with all applicable laws and with this Consent Decree. All Work shall be performed using sound engineering practices, which may include appropriate provisions of the

most recent edition of the following publications: EPA's Handbook: *Sewer System Infrastructure Analysis and Rehabilitation*, EPA/625/6-91/030, 1991; EPA's Handbook: *Condition Assessment of Wastewater Collection Systems (State of Technology Review Report)*, EPA/600/R-09/049, May 2009; EPA's Handbook: *State of Technology Report for Force Main Rehabilitation*, EPA/600/R-10/044, March 2010; *Existing Sewer Evaluation and Rehabilitation*, WEF Manual of Practice No. FD-6, 1994; *Design of Wastewater and Stormwater Pumping Stations*, WEF Manual of Practice No. FD-4; and Fla. Admin. Code. Rule 62-604; *Gravity Sanitary Sewer Design and Construction*, WEF Manual of Practice No. FD-5, 2007; *Wastewater Collection Systems Management*, WEF Manual of Practice No. FD-7, 2009; and *Recommended Standards for Wastewater Facilities*, Health Education Services (a Division of Health Research, Inc.), 2004.

18. Continuation of CMOM Programs of the First Partial Consent Decree and Second and Final Partial Consent Decree.

(a). Adequate Pumping, Transmission and Treatment Capacity Program.

Pursuant to Paragraph 16(C) of the First Partial Consent Decree (as amended by Paragraph 23 of the Second and Final Partial Consent Decree), Miami-Dade developed and implemented a program to ensure adequate transmission capacity for its Pump Stations and adequate treatment capacity for its WWTPs. Miami-Dade shall ensure adequate transmission and treatment capacity under the conditions provided for in Appendix A of this Consent Decree, attached hereto and incorporated herein. Within one hundred-eighty (180) Days of the Effective Date of this Consent Decree, Miami-Dade shall amend Section 24-42.3 of the Code of Miami-Dade County to incorporate the criteria in Appendix A.

(b). Pump Station Remote Monitoring Program. Pursuant to Paragraph 14 of the Second and Final Partial Consent Decree, Miami-Dade developed and implemented a Supervisory Control and Data Acquisition ("SCADA") program for the installation and operation of remote monitoring equipment in all Pump Stations within the WCTS. Miami-Dade shall continue to implement this program as an enforceable obligation under this Consent Decree as set forth below:

(i). Miami-Dade's Pump Station monitoring system shall continuously monitor, report and transmit information as follows:

(A). For each Pump Station that does not have dry pits and that has no more than two (2) pumps of less than or equal to 25 horsepower per pump:

- (1) highwater level alarm in wet well;
- (2) Pump Station power failure;
- (3) D.C. low battery; and
- (4) remote signal failure alarm.

(B). For each Pump Station, other than the Pump Stations described in (A) above:

- (1) operating hours after midnight for each sewage pump, total Pump Station operating hours after midnight, and number of pump starts;
- (2) wet well level with high and low level alarm set points;
- (3) kilowatts calculated from Pump Station amperage;
- (4) flow (instantaneous and average) determined from a flow meter or flow calculated based on pump(s) amperage and discharge pressure;

(5) discharge pressure with high and low level alarm set points; and

(6) minimum digital inputs, including high water level alarm in wet well, drywell flooding, intrusion alarm, A.C. Pump Station power failure, D.C. low battery and remote signal failure alarm.

(ii). With respect to all Pump Stations, system monitoring data of wet well levels, Force Main pressures, and energy requirements (kilowatts) shall be stored in a historical database. In addition, the Pump Station operating hours for each pump shall be recorded Monthly with elapsed time meters and entered into a historical database. Miami-Dade shall use radio transceivers for the primary transmission of data. Where radio paths are unreliable in areas with heavy foliage or building structures, other remote terminal units or telephone dialers or alarm systems shall be used. Miami-Dade shall retain for each Month the 24-hour maximum and the Monthly average flow data until termination of this Consent Decree.

(iii). In addition, as a continuing obligation under this Consent Decree, Miami-Dade shall require the installation of SCADA remote monitoring equipment as a condition of new construction for all new Pump Stations that it builds or receives from developers as a donation. SCADA remote monitoring equipment shall be installed within six (6) Months after Miami-Dade becomes operationally responsible for said Pump Station.

(c). WCTS Model. Pursuant to Paragraph 16 of the Second and Final Partial Consent Decree, Miami-Dade developed and implemented a computerized collection and transmission system model to assist in the development and implementation of CMOM programs to optimize transmission capacity and to evaluate the impact of I/I rehabilitation projects;

proposed modifications, upgrades and expansions to the WCTS; and performance of the WCTS. Miami-Dade shall continue to use and maintain this program as an enforceable obligation under this Consent Decree.

(i). The WCTS Model required by this Paragraph shall, at a minimum, be capable of, and be used for, predicting:

(A). Volume of wastewater flow in the Force Mains and the Major Gravity Sewer Lines, as defined in Subparagraph 18(c)(iii)(A) below, throughout Miami-Dade's WCTS;

(B). Hydraulic pressure (psig) of wastewater at any point in Force Mains throughout Miami Dade's WCTS;

(C). Flow capacity of each of the Pump Stations in Miami Dade's WCTS;

(D). Flow capacity of Pump Stations with the back-up pump out of service;

(E). Peak pumping rates for each Pump Station; and

(F). The likelihood and location of SSOs and Surcharged Conditions, as defined in Subparagraph 18(c)(iii)(D) below, within a Pump Station's service area under conditions where the Pump Station's back-up pump is out-of-service and considering available wet well capacity, off-line storage capacity, and Normal In-Line Storage Capacity, as defined in Subparagraph 18(c)(iii)(B) below.

(ii). The WCTS model shall also be capable of simulating all manifolded Force Mains and all private Pump Stations which manifold into Miami Dade's Force Main

system.

(iii). Definitions: For the purposes of this Paragraph only, the following phrases shall have the following meanings:

(A). The phrase "Major Gravity Sewer Lines" shall mean all Gravity Sewer Lines that are twenty-four (24) inches in diameter or larger, all Gravity Sewer Lines that convey wastewater from one Pump Station service area to another Pump Station service area, and all Gravity Sewer Lines that have caused or contributed, or that Miami-Dade knows will likely cause or contribute to, a capacity-related SSO.

(B). The phrase "Normal In-Line Storage Capacity" shall mean the available storage capacity within Miami-Dade's Gravity Sewer Lines, manholes and appurtenances which discharge to a Pump Station with wet well level no higher than the lower of one (1) foot below the annual low ground water table or, where suitable ground water instrumentation is available, one (1) foot below the current groundwater elevation.

(C). The phrase "Peak Flow" shall mean the greatest flow in a sewer averaged over a sixty (60) minute period at a specific location in the WCTS expected to occur as a result of a representative two (2)-year twenty-four (24)-hour rain event as determined by the South Florida Water Management District.

(D). The phrase "Surcharged Condition" shall mean the condition that exists when the wastewater flow resulting from a Peak Flow causes the wastewater level to exceed the elevation of the crown of the Pump Station influent sewer at the wet well.

(iv). Notwithstanding the foregoing, Miami-Dade shall calibrate the WCTS model at least once every five (5) years following the Effective Date of this Consent

Decree. Calibration work shall be summarized in a report which describes the calibration methodology including target allowable tolerances between model results and equivalent field values from SCADA, actual comparisons of the WCTS model results with equivalent field values from SCADA, general descriptions of adjustments made to the WCTS model, and areas for additional investigation for continued improvement of the model. The calibration report shall be made available to EPA and FDEP upon their request. Newly-constructed facilities including Pump Stations, Gravity Sewer Lines and Force Mains and associated initial and projected flows added to the WCTS shall be incorporated into the WCTS model within ninety (90) days of their incorporation into Geographic Information Systems ("GIS"). The system layout included in the WCTS model is based on importing the GIS layers for the WCTS. Procedures shall be developed so that updating of the GIS layers and the WCTS model are coordinated to the extent that the updates of the GIS WCTS layers are conveniently exportable to the WCTS model. All new facilities added to GIS will be imported into the model within ninety (90) days of their input into GIS.

(d). Spare Parts Program. Pursuant to Paragraph 20 of the Second and Final Partial Consent Decree, Miami-Dade developed and implemented an inventory management program for spare parts for the WCTS. Miami-Dade shall continue to implement this program pursuant to Subparagraphs 19(e), (f), (g), and (h) of this Consent Decree.

(e). Volume Sewer Customer Ordinance Program. Pursuant to Paragraph 22 of the Second and Final Partial Consent Decree, Miami-Dade developed and implemented a Volume Sewer Customer Program ("VSC Program") as codified in Section 24-42.2 of the

Miami-Dade County Code ("VSC Ordinance") to eliminate or otherwise control SSOs from the WCTS and the collection and transmission systems of present and future VSCs:

(i). Miami-Dade shall continue to implement the VSC Program as an enforceable obligation under this Consent Decree except as otherwise modified as set forth in Subparagraphs 18(e)(ii) and (iii) below. The existing VSC Program includes the following CMOM related programs:

(A). An I/I evaluation and rehabilitation program to reduce I/I into VSC collection and transmission systems;

(B). Identification and elimination of each illegal stormwater connection to the VSC collection and transmission systems;

(C). Inspection and rehabilitation of each Pump Station within the VSC collection and transmission systems;

(D). Installation and operation of remote monitoring equipment at each Pump Station within the VSC collection and transmission systems;

(E). Creation and maintenance of a WCTS computer model for the VSC collection and transmission systems;

(F). Implementation of maintenance and spare parts programs; and

(G). A program for the reporting of unpermitted discharges and overflows from the VSC collection and transmission systems.

(ii). Within four (4) Months of the Effective Date of this Consent Decree, Miami-Dade shall make changes to the VSC Program and the VSC Ordinance as follows:

(A). Chapter 24-42.2(4) shall be modified to require that the system model be updated at intervals of no more than five (5) years;

(B). The spare parts program required under Chapter 24-42.2(6) shall be changed to comply with Paragraph 18(e)(i)(F) and require that the listing of required spare parts shall be reviewed and updated annually; and

(C). Chapter 24-42.2(1)(f)(iii) shall be modified to require that the system map provided to the Director annually shall be provided in an electronic format compatible with the Miami-Dade GIS system.

(iii) Within four (4) Months of the Effective Date of this Consent Decree, Miami-Dade shall submit to EPA and FDEP for review and comment a proposed amendment to the VSC Ordinance which will require each existing and future VSC to implement the following items in accordance with an approved Plan of Compliance as defined in Appendix B and the scheduling requirements provided in Appendix B of this Consent Decree, attached hereto and incorporated herein:

(A). A sewer overflow response plan consistent with the requirements of Paragraph 19(b) of this Consent Decree;

(B). An information management system program consistent with the requirements of Paragraph 19(c) of this Consent Decree;

(C). A sewer system asset management plan consistent with the requirements of Paragraph 19(d) of this Consent Decree;

(D). A Gravity Sewer system operation and maintenance program consistent with the requirements of Paragraph 19(e) of this Consent Decree;

(E). A Pump Station operations and preventative maintenance program consistent with the requirements of Paragraph 19(f) of this Consent Decree; and

(F). A Force Main operations, preventative maintenance and assessment/rehabilitation program consistent with the requirements of Paragraph 19(g) of this Consent Decree.

Within one hundred eighty (180) Days of receipt of EPA's approval of the proposed amendment to the VSC Ordinance, Miami-Dade shall enact the amendment. Subject to enactment of the amendment, Miami-Dade shall immediately undertake the implementation of such amended VSC Ordinance, which shall be incorporated into, and become enforceable under this Consent Decree.

19. New CMOM Programs. Miami-Dade shall develop and implement the CMOM programs as provided below. All CMOM programs shall be developed in accordance with EPA Region IV guidance, as set forth in Appendix C, attached hereto and incorporated herein.

Miami-Dade shall ensure that each CMOM program has a written, defined purpose; a written, defined goal; is documented in writing with specific detail; is implemented by trained personnel; has established performance measures; and has written procedures for periodic review.

(a). Fats, Oils and Grease ("FOG") Control Program. Miami-Dade approved a Grease Trap Ordinance pursuant to the First Partial Consent Decree. Pursuant to the Grease Trap Ordinance, Miami-Dade implemented a FOG Control Program which allowed Miami-Dade to regulate industrial and commercial sources of oil and grease. Notwithstanding any improvements already achieved through the existing FOG Control Program, Miami-Dade shall review, evaluate and revise its Grease Trap Ordinance and FOG Control Program and submit to

EPA and FDEP for review and comment a new FOG Control Program within eighteen (18) Months after the Effective Date of this Consent Decree. Miami-Dade shall continue to implement the existing FOG Control Program as an enforceable obligation under this Consent Decree until it implements a new FOG Control Program approved by EPA and FDEP as set forth below. At a minimum, the new FOG Control Program shall apply county-wide and include the following:

(i). A FOG characterization study that shall identify the sources of FOG causing problems in the WCTS and the wastewater collection and transmission systems of the VSCs and the most appropriate method or mechanism for addressing those sources.

(ii). The legal authority to control the discharge of FOG into the WCTS and the wastewater collection and transmission systems of the VSCs, including the ability to implement a permit and enforcement program for commercial and industrial sources.

(iii). Specification of accepted devices to control the discharge of FOG into the WCTS and the wastewater collection and transmission systems of the VSCs.

(iv). Establishment of standards for the design and construction of FOG control devices including standards for capacity and accessibility, site map, design documents and as-built drawings.

(v). Establishment of FOG control device management, operations and maintenance standards, or best management practices, that address onsite record keeping requirements, cleaning frequency, cleaning standards, use of additives, and ultimate disposal.

(vi). Establishment of construction inspection protocols, including scheduling, inspection report forms, and inspection record keeping requirements, to assure that

FOG control devices are constructed in accordance with established design and construction standards.

(vii). Establishment of compliance inspection protocols, including scheduling, inspection report forms, and inspection record keeping requirements to assure that FOG control devices are being managed, operated and maintained in accordance with the established management, operation and maintenance standards or best management practices.

(viii). Establishment of a FOG disposal manifest system, with the included requirements that FOG and septage not be comingled and that the point of origin be specified on the manifest.

(ix). Establishment of an enforcement program, including specific enforcement mechanisms, to ensure compliance with the FOG Control Program.

(x). Establishment of a compliance assistance program to facilitate training of FOG generators and their employees.

(xi). Establishment of a comprehensive public education program directed at reducing the amount of FOG entering the WCTS from residences.

(xii). Establishment of staffing (technical and legal) and equipment requirements to ensure effective implementation of the FOG Control Program.

(xiii). A regularly maintained list of current commercial establishment FOG generators including a description of their FOG generating processes and estimated average quantity of FOG generated daily.

(xiv). Establishment of performance indicators to be used by Miami-Dade to measure the effectiveness of the FOG Control Program.

(xv). A schedule to review, evaluate and revise the FOG Control Program on at least an annual basis. Any revisions to the FOG Control Program shall be submitted to EPA and FDEP in accordance with Paragraph 15 of this Consent Decree.

Within one hundred-eighty (180) Days of receipt of EPA's approval of the new FOG Control Program, Miami-Dade shall enact the ordinance. Subject to enactment, Miami-Dade shall immediately undertake the implementation of the new FOG Control Program, which shall be incorporated into, and become enforceable under, this Consent Decree.

(b). Sewer Overflow Response Plan ("SORP"). Pursuant to Paragraph 15 of the First Partial Consent Decree and Paragraph 24 of the Second and Final Consent Decree, Miami-Dade developed and implemented a program for identifying and reporting SSOs. Miami-Dade shall continue to implement this program as an enforceable obligation under this Consent Decree until it implements a SORP approved by EPA and FDEP as set forth below. Within nineteen (19) Months after the Effective Date of this Consent Decree, Miami-Dade shall submit to EPA and FDEP for review and comment a SORP that will establish timely and effective methods and means of responding to, cleaning up, and/or minimizing the impact of SSOs; timely reporting of the location, volume, cause, impact, and other pertinent SSO information to the appropriate regulatory agencies; and timely and effective notification of SSOs to potentially impacted public. At minimum, the SORP shall include and provide for the following:

(i). Within twenty-four (24) hours of the time Miami-Dade first becomes aware of a SSO to waters of the United States or the State, of a SSO greater than or equal to one thousand (1,000) gallons, or of a SSO that will endanger public health or the environment, Miami-Dade shall provide in an oral report to FDEP the location of the SSO by street address or

any other appropriate method (*i.e.*, latitude-longitude). The oral report shall be given to FDEP through the State Warning Point Hotline.

(ii). Within five (5) days of the time Miami-Dade first becomes aware of a SSO to waters of the United States or the State, of a SSO greater than or equal to one thousand (1,000) gallons, or of a SSO that will endanger public health or the environment, Miami-Dade shall also provide a written report to FDEP for the SSO. Miami-Dade shall maintain a copy of any written reports prepared pursuant to this Paragraph for a period of not less than five (5) years from the date of the SSO. The written report shall contain the following:

(A). The location of the SSO by street address, or any other appropriate method (*i.e.*, latitude-longitude);

(B). The estimated date and time when the SSO began and stopped, or if it is still an active SSO, the anticipated time to stop the SSO;

(C). The steps taken to respond to the SSO;

(D). The name of the receiving water, if applicable;

(E). An estimate of the volume (in gallons) of sewage spilled;

(F). A description of the WCTS component from which the SSO was released (such as manhole, crack in pipe, Pump Station wet well or constructed overflow pipe);

(G). Subject to available information, an estimate of the SSO's impact on public health and to water quality in the receiving water body;

(H). The cause or suspected cause of the SSO;

(I). The date of the last SSO at the same point;

(J). The steps taken or to be taken to reduce, prevent, or eliminate, reoccurrence of the SSO;

(K). A list of all notifications to the public and other agencies or departments; and

(L). The steps taken or to be taken to clean up any surfaces that have been in contact and/or contaminated by the SSO.

(iii). Miami-Dade shall maintain for all SSOs for a period of not less than five (5) years from the date of the SSO all records documenting the steps that have been and will be taken to prevent the SSO from recurring, including work order records associated with investigation and repair activities related to the SSO. Miami-Dade shall also maintain for a period of not less than five (5) years from the date of the SSO a list and description of complaints from customers or others regarding the SSO.

(iv). The SORP shall provide procedures for responding to all SSOs to minimize the environmental impact and potential human health risk of SSOs. At a minimum, such response procedures shall include:

(A). A detailed description of the actions Miami-Dade will undertake to immediately provide notice to the public (through the local news media or other means including signs or barricades to restrict access) of a SSO;

(B). A detailed description of the actions Miami-Dade will undertake to provide notice to appropriate federal, state or local agencies/authorities;

(C). A detailed plan (including the development of response standard operating procedures) to minimize the volume of untreated wastewater transmitted to

the portion of the WCTS impacted by the events precipitating the SSO to minimize overflow volumes;

(D). A particular description of Miami-Dade's response to Building Backups, including the timeframe for responses and the measures to be taken to clean up Building Backups found to be caused by conditions in Miami-Dade's Sewer System, including procedures necessary to disinfect and/or remove items potentially contaminated by Building Backups such as wet vacuuming or other removal of spillage, wiping floors and walls with cleaning solution and disinfectant, flushing out and disinfecting plumbing fixtures, carpet cleaning and/or replacement and other appropriate measures to disinfect and/or remove items potentially contaminated by Building Backups; and a description of Miami-Dade's follow-up process to insure adequacy of cleanup.

(v). A detailed plan of the resources to be used to correct or repair the condition causing or contributing to the SSO.

(vi). A detailed plan to ensure the preparedness, including response training of Miami-Dade employees and personnel of other affected agencies, necessary for the effective implementation of the SORP in the event of a SSO and establishing procedures and providing adequate training to response personnel for estimating SSO volumes.

(vii). A list of those SSO locations within the area of the WCTS served by each Pump Station that have been recorded as overflowing more than once within the previous twelve (12) month period and/or those locations at which a SSO is likely to occur first in the event of a Pump Station failure.

(viii). Pump Station emergency bypass/pump-around strategies, and procedures.

(c). Information Management System ("IMS") Program. Within twenty-four (24) Months after the Effective Date of this Consent Decree, Miami-Dade shall submit to EPA and FDEP for review and comment an IMS Program, as more particularly described below. At a minimum, the IMS Program shall include the following:

(i). A management IMS component to provide Miami-Dade managers with guidance and instruction to adequately evaluate operations, maintenance, customer service, and Sewer System rehabilitation activities so that overall Sewer System performance can be determined and utility planning can be conducted. This IMS component shall utilize management reports and standard management forms.

(ii). An operations IMS component to provide Miami-Dade managers and field supervisors with guidance to adequately track scheduled operational activities and to enhance operational performance. This IMS component shall utilize operating reports and standard operation forms used by field personnel and shall provide for field supervisor review.

(iii). A maintenance IMS component to provide Miami-Dade managers and field supervisors with guidance to adequately track scheduled maintenance activities and to enhance maintenance performance. This IMS component shall utilize maintenance reports and standard maintenance forms used by field personnel. The system shall provide for field supervisor review.

(iv). A description of what information will be fed into the system, how it will be entered and by what means it will be recorded.

(v). A description of the management reports that will be generated from the input data (*i.e.*, work reports), including examples and periodicity for review of such reports.

(vi). A description of the work reports that will be prepared and submitted, including examples and periodicity for review of such reports.

(vii). Standard forms that will be used by both field personnel and management for the Program, where applicable.

(viii). A detailed description of how the records will be maintained.

(ix). If computer software will be utilized, a description of the software to be used with cited references for software training and procedures for utilizing the software.

(x). Implementation of a Geographic Information Systems ("GIS") map of its entire WCTS on or before forty-two (42) Months after the Effective Date of this Consent Decree. Specifically, Miami-Dade shall implement improvements to its current GIS as follows:

(A). An updated GIS database to include all as-builts and Active As-built Supplemental Information System ("AAS IS") forms, including new and corrected asset attribute data;

(B). Streamlining of the GIS data entry process for new assets, including electronic as-built data and necessary standards so that all new assets are added to the GIS system within ninety (90) calendar days of their activation in the field. Included shall be the development of a system to interface with the Miami-Dade WCTS hydraulic computer model so that the information can be efficiently exported to the WCTS hydraulic computer model;

(C). Simplification of the AAS IS process to facilitate wider usage;

(D). Development of a “flagging process” for damage investigators to note GIS inaccuracies;

(E). Provision for additional GIS training and refresher training;

(F). Use of Dade On-Line Facilities Information Network version II (“DOLFIN II”) to facilitate more widespread access to GIS resources to remote staff; and

(G). Determination via suitable as-built drawings, or GPS or traditional surveying field measurements, elevations of all manhole rim elevations and sewer inverts at connections to manholes and Pump Stations and their inclusion into GIS.

(xi). Development and implementation of performance indicators to provide Miami-Dade managers with guidance to adequately evaluate data collected in the IMS for use in determining the condition of the Sewer System and an evaluation of Miami-Dade’s CMOM programs. Performance indicators shall include, without limitation, the linear footage of Gravity Sewer Line and Force Main inspections, the linear footage of Gravity Sewers cleaned, the number of manholes inspected, the number of manholes cleaned/maintained, the number of inverted siphons inspected, the number of inverted siphons cleaned/maintained, the number of SSOs per mile of Gravity Sewer, the number of SSOs per mile of Force Main, the number of SSOs per Pump Station, per capita wastewater flow, NPDES Permit effluent compliance and such other performance indicators as Miami-Dade may suggest and EPA approve; and

(xii). Maintenance activity tracked by type (corrective, preventative, and emergency).

(d). Sewer System Asset Management Program. For purposes of this Consent Decree, the term “Asset Management Program” shall mean a management program that

maintains a desired level of service for Miami-Dade's Sewer System considering life cycle cost to ensure compliance with regulatory requirements and this Consent Decree. Within twenty-two (22) Months after the Effective Date of the Consent Decree, Miami-Dade shall submit to EPA and FDEP for review and comment an Asset Management Program, including a schedule for full implementation of the program. The Asset Management Program shall include the following components:

(i). A current condition assessment of all Sewer System components, including, but not limited to, Pump Station components, Gravity Sewer Lines, manholes, siphons, aerial crossings, Force Mains, etc. Miami-Dade may use data gathered from its latest round of Infiltration/Exfiltration/Inflow sewer assessments as a baseline conditional assessment to meet this component.

(ii). A statement of the level of service Miami-Dade intends to provide the customers it serves considering life cycle cost to ensure compliance with regulatory requirements and this Consent Decree.

(iii). The identification of critical assets within the Sewer System that are absolutely necessary to have in service to maintain the developed level of service.

(iv). The identification of minimum life cycle costs for each critical asset.

(v). A long-term funding plan to fully implement and be able to pay for all identified life cycle costs for each critical asset. The long-term funding plan shall include all potential sources of revenue and the likelihood of securing funding from each source.

(e). Gravity Sewer System Operations and Maintenance Program. Within fourteen (14) Months after the Effective Date of this Consent Decree, Miami-Dade shall submit

to EPA and FDEP for review and comment, a Gravity Sewer System Operations and Maintenance Program to address SSOs, particularly those caused by FOG, roots and/or debris obstructions. At a minimum, the Gravity Sewer System Operations and Maintenance Program shall include the following:

(i). Written preventative operations and maintenance schedules and procedures which shall be scheduled appropriately and shall include, but not be limited to, written procedures for the following:

(A). Inspection and maintenance of all Gravity Sewers, manholes and inverted siphons;

(B). Identifying and documenting Gravity Sewer, manhole and inverted siphon conditions, including grease, roots, and/or debris accumulation;

(C). Identifying maintenance needs; and

(D). Scheduling preventative maintenance work/cleaning which Miami-Dade may schedule in connection with the Force Main Assessment Program and/or Force Main Rehabilitation/Replacement Program as described in Subparagraphs 19(g)(iii) and (iv) below.

(ii). An engineering evaluation of potential sulfide and corrosion control options and a summary report of findings, including a recommendation of the preferred sulfide and corrosion control method(s); provided, however, that such corrosion control options and methods shall not apply to components made of plastic or other similar materials.

(iii). Prioritization for evaluating the Gravity Sewers based upon the size of the pipe (e.g., starting with the larger pipes and work back to smaller pipes), location of SSOs, community input or other criteria it finds appropriate.

(iv). Inspection of Gravity Sewers, manholes, and inverted siphon easements, including inspection of creek crossings, canal crossings, stream bank encroachment toward Gravity Sewers, manholes and inverted siphons, and easement accessibility (including the need to control vegetative growth or encroachment of man-made structures or activities that could threaten the integrity of the affected Gravity Sewer, manhole, or inverted siphon).

Inspections shall include written reports, and where appropriate, representative photographs or videos of appurtenances being inspected (Gravity Sewers, manholes, inverted siphons, creek crossings, canal crossings, etc.). Inspectors shall promptly report any observed SSOs to their area supervisors and shall record any evidence of SSOs which may have occurred since the last inspection. Any observed SSO shall be promptly reported in accordance with the SORP.

(v). A schedule for the maintenance of easements.

(vi). A staffing and funding plan sufficient in structure, skills, numbers and funding to allow completions of the operation and maintenance activities required by this Subparagraph 19(e).

(vii). Data attributes for Miami-Dade's mapping program allowing program data to be compared in Miami-Dade's IMS against other pertinent data such as the occurrence of SSOs, including repeat SSO locations and permit violations.

(viii). An inventory management system that includes:

(A). A list of critical equipment and critical spare parts;

(B). A list of where critical spare parts and critical equipment may be secured to allow repairs in a reasonable amount of time for those spare parts and critical equipment that are not stored by Miami-Dade, including spare pipe having a diameter of 48 inches or greater; the list shall also set forth an inventory of spare parts and critical equipment stored by Miami-Dade, as applicable; and

(C). Written procedures for updating the critical spare parts and equipment inventories in the IMS.

(ix). Reports which list equipment problems and the status of work orders generated during the prior Month.

(f). Pump Station Operations and Preventative Maintenance Program. Within sixteen (16) Months after the Effective Date of this Consent Decree, Miami-Dade shall submit to EPA and FDEP for review and comment a Pump Station Operations and Preventative Maintenance Program to facilitate proper operation and maintenance activities associated with the Pump Stations within the WCTS. At a minimum, the Pump Station Operations and Preventative Maintenance Program shall include the following:

(i). Identification of the means and modes of communication between Pump Stations, field crews, and supervising staff.

(ii). Technical specifications of each Pump Station within the WCTS.

(iii). A description of each Pump Station monitoring system which shall continuously monitor, report, and transmit information for each Pump Station.

(iv). Written preventative operations and maintenance schedules and procedures which shall be scheduled appropriately and shall include, but not be limited to, written procedures for the following:

(A). Periodic service and calibration of instrumentation such as flow meters, liquid level sensors, alarm systems, elapsed time meters, and remote monitoring equipment;

(B). Predictive (including non-physical inspections) and/or physical inspection and service for all Pump Stations including, but not limited to:

(1) reading, recording and maintaining records of information from the elapsed time meters and pump start counters;

(2) observing and documenting wet well conditions, including grease and/or debris accumulation;

(3) checking and re-setting, as necessary to improve system performance, wet well pumping points (*e.g.*, floats);

(4) checking, recording and maintaining records of system pressure(s);

(5) checking SCADA and/or alarm components;

(6) checking stand-by power sources;

(7) checking motor electrical system, including, but not limited to, line voltage on each leg quarterly, current draw on each leg quarterly, and resistance of windings on each leg quarterly; and

(8) identifying maintenance needs.

(v). Written standard emergency/reactive operations and maintenance procedures. Miami-Dade, subject to its discretion, may use portable pumps, portable generators or alternative power sources as it deems appropriate. At a minimum, the standard emergency/reactive Pump Station operating procedures shall include:

(A). Criteria used to determine the need for emergency operations and maintenance;

(B). Initiation/use of stand-by power (*e.g.*, portable generators), where applicable;

(C). Initiation/use of portable pump (*e.g.*, bypass/pump-around operations), where applicable.

(D). Evaluation of the need for additional equipment for emergency/reactive operations, including, but not limited to, additional portable generators and/or additional portable pumps (for pump-around operations);

(E). Evaluation of the need for on-site standby power (*e.g.*, on-site generator and/or second electrical feed from the power grid) for each Pump Station should Miami-Dade choose, subject to its discretion, not to have a portable pump available for the Pump Station; and

(F). Establishing standard forms, reporting procedures and performance measures for emergency/reactive operations and maintenance.

(vi). An inventory management system that includes:

(A). A list of critical equipment and critical spare parts;

(B). A list of where critical spare parts and critical equipment may be secured to allow repairs in a reasonable amount of time for those spare parts and critical equipment that are not stored by Miami-Dade; the list shall also set forth an inventory of spare parts and critical equipment stored by Miami-Dade, as applicable; and

(C). Written procedures for updating the critical spare parts and equipment inventories in the IMS.

(vii). Reports which list equipment problems and the status of work orders generated during the prior Month.

(viii). A staffing and funding plan sufficient in structure, skills, numbers and funding to allow completion of the operations and maintenance activities required by this Subparagraph 19(f).

(g). Force Main Operations, Preventative Maintenance and Assessment/Rehabilitation Program.

(i). Within twenty (20) Months after the Effective Date of this Consent Decree, Miami-Dade shall submit to EPA and FDEP for review and comment a Force Main Operations, Preventative Maintenance and Assessment/Rehabilitation Program to facilitate proper operations and maintenance activities associated with Force Mains within the WCTS. At a minimum, the Force Main Operations, Preventative Maintenance and Assessment/Rehabilitation Program shall include the following:

(A). The assessment of Force Mains, including an evaluation of potential sulfide and corrosion control options, and a summary report of findings, including a recommendation of the preferred sulfide and corrosion control method(s); provided, however,

that such corrosion control options and methods shall not apply to components made of plastic or other similar materials;

(B). The Inspection of Force Main easements, including inspection of canal crossings, stream bank encroachment toward Force Mains, and easement accessibility to identify whether further action would be necessary for Miami-Dade to be able to have access should a problem arise. Inspections shall include written reports, and where appropriate, representative photographs or videos of appurtenances being inspected (Force Mains, creek crossings, canal crossings, etc.). Inspectors shall promptly report any observed SSOs to their area supervisors and shall record any evidence of SSOs which may have occurred since the last inspection. Any observed SSO shall be promptly reported in accordance with the SORP.

(C). A schedule for the maintenance of easements.

(D). A staffing and funding plan sufficient in structure, skills, numbers and funding to allow completion of the activities required by this Subparagraph 19(g).

(E). An inventory management system that includes:

(1). A list of critical equipment and critical spare parts;

(2). A list of where critical spare parts and critical equipment may be secured to allow repairs in a reasonable amount of time for those spare parts and critical equipment that are not stored by Miami-Dade (*e.g.*, spare pipe having a diameter of 48 inches or greater); the list shall also set forth an inventory of spare parts and critical equipment stored by Miami-Dade, as applicable; and

(3). Written procedures for updating the critical spare parts and equipment inventories in the IMS.

(F). Reports which list equipment problems and the status of work orders generated during the prior Month.

(ii). Force Main Criticality Assessment and Prioritization Report. Within nine (9) Months after EPA's approval of the Force Main Operations, Preventative Maintenance and Assessment/Rehabilitation Program, Miami-Dade shall submit to EPA and FDEP for review and comment a Force Main Criticality Assessment and Prioritization Report that shall set forth the results of Miami-Dade's criticality assessment of the structural integrity of its Force Mains and the risk of Force Main critical failure. Miami-Dade shall base its criticality assessment of a Force Main on any previous assessments or investigations regarding the structural integrity of the Force Main, the size of the Force Main (*e.g.*, gallons per day capacity and/or diameter), the age of the Force Main, the pipe material of the Force Main, the length of the Force Main, the availability (including distance) of the nearest WCTS component which could handle flows from that Force Main in the event of failure, the operating pressure of the Force Main during peak flow events, the availability of new pipe in case of failure (*i.e.* for large diameter Force Mains). Miami-Dade shall use this criticality assessment to prioritize its Force Mains for further assessment and/or rehabilitation/replacement pursuant to the Force Main Assessment Program and the Force Main Rehabilitation/Replacement Program set forth below. The Force Main Criticality Assessment and Prioritization Report shall include the results of Miami-Dade's Force Main prioritization for further assessment and/or rehabilitation/replacement of its Force Mains, including a prioritized schedule for implementation of the Force Main Assessment Program

provided, however, that all Force Mains shall be assessed pursuant to the Force Main Assessment Program on or before sixty (60) Months after approval by the EPA of the Force Main Criticality Assessment and Prioritization Report.

(iii). Force Main Assessment Program. Miami-Dade shall implement the Force Main Assessment Program in accordance with the schedule set forth in the Force Main Criticality Assessment and Prioritization Report. At a minimum, the Force Main Assessment Program shall include the following:

(A). Standard procedures and schedules for continual above-ground assessment of the route(s) of each Force Main in the WCTS. This component shall include standard forms for the visual assessment of Force Main routes and ground level conditions that may show structural issues with the Force Main below ground.

(B). Standard procedures and schedules for continual assessment of the route(s) of each Force Main in the WCTS where it crosses a surface water body and/or drainage way. This component shall include standard forms for the visual assessment of Force Main routes and above ground conditions that may show structural or leakage issues with the Force Main where it crosses a surface water body and/or drainage way.

(C). Standard procedures and schedules for inspecting and identifying Force Mains that are either corroded or at risk of corrosion. This component shall include a system for prioritizing repair of corrosion defects, corrosion identification forms, and

(D). Standard procedures and schedules for monitoring all existing cathodic protection measures on existing Force Mains, as well as detailed cathodic protection requirements for any newly installed Force Mains.

(E). Standard procedures and schedules for implementing acoustic monitoring of the Force Mains. The acoustic monitoring component shall include leak detection, acoustic monitoring (*i.e.*, monitoring for wire breaks in pre-stressed concrete cylinder Pipe), and Sonar or Ultrasonic monitoring for pipe defect analysis (*e.g.*, pipe wall deflections, corrosion, pits, voids, cracks, and debris). Any resulting internal wall thickness measurements shall be used to establish a list of potential corrosion problems and rehabilitation of the Force Main to prevent line breaks and/or ability to operate under pressures experienced during peak flow events.

(F). Criteria for use of ground-penetrating radar to determine leaks, Force Main bedding conditions and/or Force Main bedding voids.

(G). Assessment of the feasibility of installation of parallel Force Mains in the case of emergency repairs of those Force Mains determined by Miami-Dade to be highly critical.

(iv). Force Main Rehabilitation/Replacement Program. Within twenty-four (24) Months after the Effective Date of this Consent Decree, Miami-Dade shall submit to EPA and FDEP for review and approval a Force Main Rehabilitation/Replacement Program. At a minimum, the Force Main Rehabilitation/Replacement Program shall include the following:

(A). Standard procedures for repairing each Force Main in the WCTS that is deemed to be in need of repair pursuant to the Force Main Criticality Assessment and Prioritization Report and/or Force Main Assessment Program. Repair technologies shall include, but not be limited to, open cut replacement of section(s) of pipe, spot repairs using

cured-in-place pipe ("CIPP"), mechanical sleeves or repair clamps, or joint repairs using internal sleeves or external devices.

(B). Standard procedures for rehabilitating each Force Main in the WCTS that is deemed to be in need of rehabilitation pursuant to the Force Main Criticality Assessment and Prioritization Report and/or Force Main Assessment Program. Rehabilitation technologies shall include, but not be limited to, spray-on linings, close fit linings, CIPP, and woven hose linings (including adhesive-backed linings, non-adhesive backed linings and glass-reinforced thermoplastic linings).

(C). Standard procedures for replacing each Force Main in the WCTS that is deemed to be in need of replacement pursuant to the Force Main Criticality Assessment and Prioritization Report and/or Force Main Assessment Program. Replacement technologies shall include, but not be limited to, open cut replacement of pipe, sliplining, pipe bursting, directional drilling, and microtunneling/pipe jacking.

Miami-Dade shall implement the Force Main Rehabilitation/Replacement Program in accordance with the prioritization of the Force Main Criticality Assessment and Prioritization Report and based on the results and finding of its implementation of the Force Main Assessment Program; provided, however, that all Force Mains shall be repaired, rehabilitated or replaced pursuant to the Force Main Assessment Program on or before sixty (60) Months after completion of the condition assessment. Within three (3) Months after completion of all work pursuant to the Force Main Rehabilitation/Replacement Program, Miami-Dade shall submit to EPA and FDEP for review and comment a Force Main Rehabilitation/Replacement Program Final Report summarizing the implementation of the Program.

(h). WWTP Operations and Maintenance Program. Within seventeen (17) Months of the Effective Date of this Consent Decree, Miami-Dade shall submit to EPA and FDEP for review and approval a WWTP Operations and Maintenance Program to facilitate proper operation, maintenance and equipment replacement activities associated with the WWTPs. At a minimum, the WWTP Operations and Maintenance Program shall include the following:

(i). A prioritization of WWTP equipment as critical, semi-critical or non-critical based upon an evaluation of the impacts of the loss of use or failure of each piece of WWTP equipment. Such prioritization shall include the following WWTP equipment, as it applies specifically to each Miami-Dade operated WWTP:

(A). In-plant raw sewage conveyance, including, but not limited to, raw sewage transmission pipes, flow meters and valves;

(B). Pretreatment screening, including, but not limited to, bar screen equipment, perforated plate screen equipment, concrete channels and structures, and screening collection, compaction and conveyance equipment;

(C). Influent grit chamber equipment, including but not limited to, aeration equipment and physical grit removal equipment (e.g., chains and pins, gear boxes, motors, conveyors, etc.);

(D). Primary clarifiers, including, but not limited to, concrete tank and structures, scum skimmer equipment, sludge collection mechanism and equipment, covers, ventilation systems, and primary sludge pumping systems;

(E). Aeration/oxygenation tank equipment, including but not limited to, motors, aeration blades, effluent trough screens, effluent trough air diffusion equipment and oxygen generation equipment;

(F). Final settling tank equipment, including, but not limited to, scum skimmer equipment, sludge collection mechanism and equipment, covers, ventilation systems, effluent weirs, and concrete tank and structures.

(G). Return activated sludge ("RAS") equipment, including but not limited to, pump control equipment, RAS pumps and physical equipment (e.g., air conditioning);

(H). Sludge thickener and digester equipment, including but not limited to, sludge digester tanks/covers, gas and sludge mixers, heat exchangers and internal pumps;

(I). Sludge dewatering, including, but not limited to, centrifuge equipment, polymer systems, centrate handling and on-site sludge hauling and transferring vehicles.

(J). Effluent disinfection, including, but not limited to, chlorine gas equipment, bulk hypochlorite solution storage, on-site hypochlorite generation equipment, and chlorine solution dosage and distribution equipment;

(K). Chlorine contact chamber, including, but not limited to, concrete tank, diffuser and structures;

(L). Effluent disposal, including, but not limited to, effluent pumping equipment, effluent wet well, effluent surge tank, effluent outfalls and diffusers, effluent deep injection wells, industrial and public reuse treatment and distribution equipment;

(M). Yard piping, including, but not limited to, pipes, flow metering and valves;

(N). Odor control systems, including, but not limited to, air scrubbing towers, blower equipment and duct work, and chemical storage and metering equipment;

(O). Tertiary treatment, including, but not limited to, screw pump equipment, flocculation tanks, polymer system, and deep bed sand filter equipment;

(P). Biosolids handling, including, but not limited to, sludge drying beds, composting equipment, and biosolids handling heavy equipment;

(Q). Septage, fats, oils, and grease receiving facility, including, but not limited to, septic truck receiving station equipment, septage screening equipment; and solids/ liquid/scum separation equipment;

(R). Laboratory, training and administration facilities;

(S). Ferric salts dosing facilities; and

(T). WWTP electrical equipment, including, but not limited to, motor control centers, remote telemetry units, metering, SCADA equipment, electrical conduit, electrical breakers, on-site emergency generators, biogas conveyance, biogas condition systems, methane storage spheres, and combined heat and power co-generation equipment.

(ii). A schedule for preventative maintenance activities that is as expeditious as possible. Miami-Dade shall develop a schedule for preventative maintenance activities such as grit chamber equipment maintenance, aeration tank equipment maintenance, final settling tank equipment maintenance, sludge thickener and digester equipment maintenance, electrical equipment maintenance (e.g., on-site generators and electrical co-generation equipment), pump maintenance (e.g., preventative lubrication and packing maintenance), mechanical maintenance, physical maintenance (e.g. building repairs, equipment painting, and grounds upkeep) and other maintenance activities as needed at Miami-Dade's WWTPs that is as expeditious as possible. Such schedule shall include, but not be limited to, manufacturers' maintenance recommendations.

(iii). A maintenance information management system that shall have the capability of scheduling and tracking both preventative and reactive maintenance activities.

(iv). An inventory of spare parts. Miami-Dade shall identify which critical spare parts are maintained in inventory and provide a schedule to purchase critical spare parts that are not in inventory.

(v). A spare parts inventory control system. Miami-Dade shall also develop, either as part of the maintenance information management system, or as a separate data management system, an inventory control system that shall have the capability of tracking spare parts use and inventory, as well as generating inventory replenishment needs reports.

(vi). A staffing and funding plan sufficient in structure, skills, numbers and funding to allow completion of the activities required by this Subparagraph 19(h).

(vii). An active control program for hauled wasteloads to the WWTP that includes, but is not limited to: hauled wasteload receiving station(s) that allow the control of flow and loadings from a wasteload into the WWTP; communication, data collection, documentation, and other standard operating procedures to effectively determine, prior to acceptance of a wasteload into the WWTP, the sources of an individual domestic or non-domestic wasteload, the pollutant characteristics of an individual wasteload, and the compliance of an individual wasteload with applicable federal and local standards and requirements. Miami-Dade shall submit an implementation schedule for the program, and shall develop the program using the considerations and recommendations in the EPA's Handbook: *Guidance Manual for Control of Hauled Wastes*, EPA-833-B-98-003 (September 1999) to the extent applicable and appropriate.

(i). Specific Capital Improvement Projects. Based on previous investigations, Miami-Dade has identified certain rehabilitation projects that are intended to address conditions currently causing SSOs or contributing to NPDES permit violations. These specific capital improvement projects are identified and described in the Work Plan set forth in Appendix D, attached hereto and incorporated herein. Miami-Dade shall complete each of these capital improvement projects in accordance with the schedules set forth in Appendix D. The Parties acknowledge that Miami-Dade's implementation of the Ocean Outfall Legislation may impact the scope and scheduling of certain capital improvement projects identified in Appendix D of this Consent Decree. Notwithstanding any other right Miami-Dade may have to seek a modification to this Consent Decree, the Parties therefore acknowledge that Miami-Dade may request of EPA and FDEP modifications to the scope and scheduling of such capital

improvement projects as set forth in Appendix D. Any such request shall include a demonstration by Miami-Dade of how implementation of the Ocean Outfall Legislation impacts the scope or scheduling of a capital improvement project; why the scope or scheduling of an affected capital improvement project should be modified because of implementation of the Ocean Outfall Legislation; whether any such requested modification is necessary in order for Miami-Dade to comply with the Ocean Outfall Legislation; and how the proposed modification would affect Miami-Dade's compliance with the CWA, the regulations promulgated thereunder, Fla. Stat. Chapter 403, and the applicable Fla. Admin. Code Rules promulgated thereto, as well as the NPDES Permits. Except as provided below, any modifications agreed upon in writing by the United States, FDEP, and Miami-Dade to this list of projects or schedules set forth in Appendix D shall constitute a non-material change to this Consent Decree as set forth in Section XX (Modification) below. Notwithstanding the foregoing, any deletion of an entire project set forth in **bold** and delineated by an ID number with one decimal point (e.g. 1.1) in Appendix D agreed upon in writing by the United States, FDEP and Miami-Dade shall constitute a material change to this Consent Decree as set forth in Section XX (Modification) below. Additionally, Miami-Dade shall complete all the capital improvement projects set forth in Appendix D on or before fifteen (15) years from the Date of Lodging, and any modification agreed upon in writing by the United States, FDEP, and Miami-Dade to this final compliance date shall be considered a material change to this Consent Decree as set forth in Section XX (Modification) below.

(j). Financial Analysis Program. Within twelve (12) Months after the Effective Date of this Consent Decree, Miami-Dade shall submit to EPA and FDEP for review and approval a Financial Analysis Program to ensure that it can effectively establish and track

the sufficiency of funds for operations and maintenance, capital projects financing, and debt service coverage associated with the Sewer System, including, without limitation, the continued implementation of the Work pursuant to this Consent Decree. The Financial Analysis Program shall be consistent with the following criteria:

(i). A program that regularly analyzes and projects future utility management, operations, and maintenance costs needed to effectively manage, operate, and maintain the Sewer System, including, without limitation, the continued implementation of the CMOM Programs required pursuant to Paragraphs 18 and 19 of this Consent Decree. The cost analyses should include, at a minimum: capital infrastructure improvements; labor needs (including a staffing plan); and equipment and materials needs.

(ii). A program that analyzes, projects, plans, and finances capital improvement needs established through engineering studies; Sewer System condition assessments; historical Sewer System management, operations, and maintenance cost data; and sound sewer infrastructure asset management programs, including, without limitation, capital improvement needs established and required pursuant to Paragraphs 18 and 19 of this Consent Decree. Capital improvement financing should be planned using a five (5) year planning horizon with annual updates.

(iii). A program that establishes the annual utility budget and customer rates periodically. The program should assure that the budget and funding provided by customer rates will meet the cost and financing needs for the management, operation, and maintenance of the Sewer System and the capital improvement needs as identified pursuant to the procedures set forth in Subparagraphs 19(j)(i) and (ii) above.

(iv). A program that directly tracks and reports operation and maintenance costs by the type of activity (corrective, preventative, and emergency) and capital improvement costs.

(v). A program that tracks and reports any transfer or use of funds obtained by Miami-Dade from the collection of sewer rates for any purpose not related to the management, operation, or maintenance of the Sewer System or to any capital improvement needs of the Sewer System. Such transfers or uses of funds to be tracked and reported in this program do not apply to funds internally used within the Miami-Dade Water and Sewer Department and funds transferred or used to administratively reimburse other departments or agencies within Miami-Dade for services rendered to the Miami-Dade Water and Sewer Department for purposes related to the management, operation, or maintenance of the Sewer System or to any capital improvement needs of the Sewer System. The amount, recipient and date of any such use or transfer of funds to be tracked and reported in this program also shall be included in the semi-annual report as provided in Paragraph 33 of this Consent Decree. Miami-Dade shall also provide thirty (30) days advance written notice to the United States and FDEP of Miami-Dade's intent to transfer or use funds required to be tracked and reported in this program.

VII. CIVIL PENALTY

20. Within thirty (30) Days after the Date of Entry of this Consent Decree, Miami-Dade shall pay the sum of \$978,100 as a civil penalty in accordance with the provisions of Paragraphs 21 and 22.

21. Miami-Dade shall pay to the United States \$511,800 of the civil penalty due by FedWire Electronic Funds Transfer ("EFT") to the U.S. Department of Justice in accordance

with written instructions to be provided to Miami-Dade, following the Date of Entry of this Consent Decree, by the Financial Litigation Unit of the U.S. Attorney's Office for the Southern District of Florida, 99 N.E. 4th Street, Miami, Fl. 33132, (305) 961-9001. At the time of payment, Miami-Dade shall send a copy of the EFT authorization form and the EFT transaction record, together with a transmittal letter, which shall state that the payment is for the civil penalty owed pursuant to the Consent Decree in United States et al. v. Miami-Dade County, and shall reference the civil action number and DOJ case number 90-5-1-1-4022/1, to the United States in accordance with Section XVII of this Consent Decree (Notices); by email to acctsreceivable.CINWD@epa.gov; and by mail to:

EPA Cincinnati Finance Office
26 Martin Luther King Drive
Cincinnati, Ohio 45268

In the event that full cash payment to the United States is not made within thirty (30) Days of the Date of Entry of this Consent Decree, Miami-Dade shall pay to the United States interest on the balance due from the original due date to the date of payment, at the rate calculated pursuant to 28 U.S.C. § 1961.

22. Miami-Dade shall pay to FDEP \$466,300 of the civil penalty due by check payable to the "Florida Department of Environmental Protection." The check shall reference the case name and include a notation to the "Ecosystem Restoration Trust Fund" and shall be sent to:

Florida Department of Environmental Protection
Southeast District
Attn: Compliance/Enforcement Section
400 N. Congress Ave.
West Palm Beach, FL 33401

In the event that full cash payment to FDEP is not made within thirty (30) Days of the Date of Entry of this Consent Decree, Miami-Dade shall pay to FDEP interest on the balance due from the original due date to the date of payment, at the rate calculated pursuant to 28 U.S.C. § 1961.

VIII. SUPPLEMENTAL ENVIRONMENTAL PROJECT

23. Miami-Dade shall satisfactorily implement and complete a Supplemental Environmental Project ("SEP") in accordance with this Section VIII (Supplemental Environmental Project) and Appendix E of this Consent Decree. The SEP shall be completed in accordance with the schedule set forth in Appendix E.

24. The SEP shall include the installation of approximately seven thousand six hundred and sixty (7,660) linear feet of Gravity Sewers within a corridor designated by the Miami-Dade Board of County Commissioners as the "Miami-Dade Green Technology Corridor," which will facilitate the connection to the Sewer System of approximately seventy four (74) business entities currently using septic tanks. Miami-Dade may use contractors or consultants in planning and implementing the SEP.

25. With regard to the SEP, Miami-Dade certifies the truth and accuracy of each of the following:

(a). That all cost information provided to EPA in connection with EPA's approval of the SEP is complete and accurate and that Miami-Dade in good faith estimates that the cost to implement the SEP is \$2,047,200.

(b). That, as of the date of executing this Consent Decree, Miami-Dade is not required to perform or develop the SEP by any federal, state, or local law or regulation and is not

required to perform or develop the SEP by agreement, grant, or as injunctive relief awarded in any other action in any forum.

(c). That Miami-Dade is not a party to any Open Federal Financial Assistance Transaction that is funding or could be used to fund the same activity as the SEP, and that there is no such open federal financial transaction that is funding or could be used to fund the same activity as the SEP, nor has the same activity been described in an unsuccessful federal financial assistance transaction proposal submitted to EPA within two (2) years of the date of Miami-Dade's execution of this Consent Decree (unless the project was barred from funding as statutorily ineligible). For purposes of this certification, the term "Open Federal Financial Assistance Transaction" refers to a grant, cooperative agreement, loan, federally-guaranteed loan guarantee or other mechanism for providing federal financial assistance whose performance period has not yet expired.

(d). That the SEP is not a project that Miami-Dade was planning or intending to construct, perform, or implement other than in settlement of the claims resolved in this Consent Decree.

(e). That Miami-Dade has not received and will not receive credit for the SEP in any other enforcement action.

(f). That Miami-Dade will not receive any reimbursement for any portion of the SEP from any other person.

26. SEP Completion Report. Within thirty (30) Days after the date set for completion of the SEP, Miami-Dade shall submit a SEP Completion Report to the EPA and FDEP for

review and comment. The SEP Completion Report shall contain all of the following information:

- (a). A detailed description of the SEP as implemented.
- (b). A description of any problems encountered in completing the SEP and the solutions thereto.
- (c). An itemized list of all eligible SEP costs expended.
- (d). Certification that the SEP has been fully implemented pursuant to the provisions of this Consent Decree.
- (e). A description of the environmental and public health benefits resulting from implementation of the SEP (with a quantification of the benefits and pollutant reductions, if feasible).

27. EPA may, in its sole discretion, require information in addition to that described in the preceding Paragraph, in order to evaluate Miami-Dade's SEP Completion Report.

28. After receiving the SEP Completion Report, EPA shall notify Miami-Dade whether or not Miami-Dade has satisfactorily completed the SEP. If Miami-Dade has not completed the SEP in accordance with this Consent Decree, stipulated penalties may be assessed under Section X of this Consent Decree (Stipulated Penalties).

29. Disputes concerning the satisfactory performance of the SEP and the amount of eligible SEP costs may be resolved under Section XII of this Consent Decree (Dispute Resolution).

30. Each submission required under this Section shall be signed by an official with knowledge of the SEP and shall bear the certification language set forth in Paragraph 16.

31. Any public statement, oral or written, in print, film, or other media, made by Miami-Dade making reference to the SEP under this Consent Decree shall include the following language: "This project was undertaken in connection with the settlement of an enforcement action, United States et al. v. Miami-Dade County, taken on behalf of the U.S. Environmental Protection Agency and the Florida Department of Environmental Protection under the Clean Water Act."

IX. REPORTING REQUIREMENTS

32. Quarterly Reports. Beginning one (1) Month after the first Calendar Quarter following the Effective Date of this Consent Decree, and one (1) Month after each Calendar Quarter thereafter until termination of the Consent Decree, Miami-Dade shall submit to EPA and FDEP for review and comment a Quarterly Report. Such Quarterly Reports shall include the date, time, location, source, estimated duration, estimated volume, receiving water (if any), and cause of all SSOs occurring in the previous Calendar Quarter. In reporting such data, Miami-Dade shall provide the information in a tabulated electronic format (*e.g.*, Excel spreadsheet) as it deems appropriate.

33. Semi-Annual Reports. Beginning one (1) Month after the first two (2) Calendar Quarters following the Effective Date of this Consent Decree, and one (1) Month after each subsequent two (2) Calendar Quarters until termination of the Consent Decree, Miami-Dade shall submit to EPA and FDEP for review and comment a Semi-Annual Report. Six (6) years from the Effective Date of this Consent Decree and each subsequent year until termination, the United States, FDEP, and Miami-Dade agree to consider whether to discontinue the Semi-Annual Reports. If the United States, FDEP, and Miami-Dade agree to discontinue the Semi-

Annual Reports, such modification shall be considered a non-material change to this Consent Decree pursuant to Section XX (Modification); and the information required in Subparagraphs 33(a) through (d) below shall then be included in each Annual Report submitted pursuant to Paragraph 34 and shall cover the applicable Calendar Year rather than two (2) Calendar Quarters. Each Semi-Annual Report shall include, at a minimum:

(a). A description of projects and activities completed and milestones achieved during the previous two (2) Calendar Quarters pursuant to the requirements of this Consent Decree, in Gantt chart or similar format, including a description of the status of compliance or non-compliance with the requirements of this Consent Decree and, if applicable, the reasons for non-compliance. If any non-compliance cannot be fully explained at the time the report is due, Miami-Dade shall include a statement to that effect in the report. Miami-Dade shall investigate to determine the cause of the non-compliance and then shall submit an amendment to the report, including a full explanation of the cause of the non-compliance, within thirty (30) Days after submission of the report.

(b). A summary of significant projects and activities anticipated to be performed, and milestones anticipated to be achieved, in the successive two (2) Calendar Quarters to comply with the requirements of this Consent Decree, in Gantt chart or similar format.

(c). The amount, recipient and date of any transfer or use during the previous two (2) Calendar Quarters of funds obtained by Miami-Dade from the collection of sewer rates for any purpose not related to the management, operation or maintenance of the Sewer System or to any capital improvement needs of the Sewer System that is required to be tracked and reported

pursuant to the Financial Analysis Program set forth in Subparagraph 19(j)(v) of this Consent Decree.

(d). Any additional information Miami-Dade determines is appropriate to demonstrate that Miami-Dade is implementing the remedial actions required under this Consent Decree in an adequate and timely manner.

34. Annual Reports. Beginning two (2) Months after the first full Calendar Year following the Effective Date of this Consent Decree, and two (2) Months after each subsequent Calendar Year until termination of this Consent Decree, Miami-Dade shall submit to EPA and FDEP for review and comment an Annual Report. Each Annual Report shall cover the most recent applicable Calendar Year and shall include, at a minimum:

(a). A narrative summary of progress made, including key accomplishments and significant activities, under the CMOM Programs implemented or modified pursuant to this Consent Decree for the most recent Calendar Year.

(b). A trends analysis of the number, volume, average duration, and cause of Miami-Dade's SSOs for the previous two (2) Calendar Years.

35. Except as otherwise provided in the SORP, whenever any violation of this Consent Decree or any other event affecting Miami-Dade's performance under this Consent Decree or its NPDES Permits may pose an immediate threat to the public health or welfare or the environment, Miami-Dade shall notify EPA and FDEP orally or by electronic or facsimile transmission as soon as possible, but no later than twenty-four (24) hours after Miami-Dade first knew of the violation or event.

36. All reports shall be submitted to the persons designated in Section XVII of this Consent Decree (Notices) for EPA and FDEP and shall be certified pursuant to Paragraph 16 of this Consent Decree. The certification requirement in Paragraph 16 does not apply to emergency or similar notifications where compliance would be impractical. In addition, a copy of all reports submitted pursuant to this Section IX (Reporting Requirements) shall also be made available to the public in the PDR.

37. Compliance with this Section does not relieve Miami-Dade of any other reporting obligations required by the CWA, Florida law, implementing regulations, or by any other Federal, state, or local law, regulation, permit, or other requirement, including the NPDES Permits.

38. Notification to EPA or FDEP pursuant to this Section of an anticipated delay shall not by itself excuse the delay or otherwise satisfy the notification requirements set forth in Section XI (Force Majeure).

39. Any information provided pursuant to this Consent Decree may be used by the United States, FDEP, and/or the State in any proceeding to enforce the provisions of this Consent Decree and as otherwise permitted by law.

X. STIPULATED PENALTIES

40. After the Date of Entry, Miami-Dade shall be liable for stipulated penalties to the United States and FDEP for violations of this Consent Decree as specified below, unless excused under Section XI (Force Majeure). A violation includes failing to perform any obligation required by the terms of this Consent Decree, including any work plan or schedule approved

under this Consent Decree, according to all applicable requirements of this Consent Decree and within the specified time schedules established by or approved under this Consent Decree.

41. If Miami-Dade fails to pay the civil penalty required to be paid under Section VII of this Consent Decree (Civil Penalty) when due, Miami-Dade shall pay a stipulated penalty of \$1,000 per day for each day that the payment is late.

42. The following stipulated penalties shall accrue for each violation identified below:

(a). SSOs.

(i). For each SSO reaching waters of the United States due to a release of wastewater from the WCTS less than or equal to 10,000 gallons, a stipulated penalty of \$500 may be assessed.

(ii). For each SSO reaching waters of the United States due to a release of wastewater from the WCTS greater than 10,000 gallons but less than or equal to 250,000 gallons, a stipulated penalty may be assessed as follows:

<u>If SSO Occurs</u>	<u>Penalty Per SSO</u>
Within 2 years of Date of Entry	\$500
Between 2 years and 5 years from Date of Entry	\$1,000
More than 5 years from Date of Entry	\$2,000

(iii). For each SSO reaching waters of the United States due to a release of wastewater from the WCTS greater than 250,000 gallons but less than or equal to 1,000,000 gallons, a stipulated penalty may be assessed as follows:

<u>If SSO Occurs</u>	<u>Penalty Per SSO</u>
Within 2 years of Date of Entry	\$1,000
Between 2 years and 5 years from Date of Entry	\$2,500
More than 5 years from Date of Entry	\$5,000

(iv). For each SSO reaching waters of the United States due to a release of wastewater from the WCTS greater than 1,000,000 gallons, a stipulated penalty may be assessed as follows:

<u>If SSO Occurs</u>	<u>Penalty Per SSO</u>
Within 2 years of Date of Entry	\$2,000
Between 2 years and 5 years from Date of Entry	\$5,000
More than 5 years from Date of Entry	\$10,000

(v). For each SSO due to a release of wastewater from the WCTS of 1,000 gallons or more that does not reach waters of the United States, a stipulated penalty may be assessed by FDEP based on the tiered volume and time thresholds provided in Subparagraphs 42(a)(i) through (iv), provided, however, that the amounts that may be assessed shall be half of the amounts listed therein.

(vi) Miami-Dade shall not be liable for stipulated penalties under this Paragraph 42 if Miami-Dade demonstrates that the SSO was caused by an Act of God, vandalism, a non-County Contractor, or any act of a third party not working directly or indirectly on behalf of Miami-Dade, and Miami-Dade demonstrates that it has used all reasonable measures to prevent such SSO.

(b). Failure to Timely Submit Deliverable. For each day Miami-Dade fails to Timely submit any Deliverable, a stipulated penalty for each such Deliverable may be assessed as follows:

<u>Period of Noncompliance:</u>	<u>Penalty Per Deliverable Per Day:</u>
One (1) to thirty (30) days	\$1,000
More than thirty (30) days	\$2,000

(c). Failure to Meet Deadlines in Appendix D. For each day Miami-Dade fails to complete the rehabilitation projects pursuant to and in accordance with the final deadlines set forth in **bold** in Appendix D, daily stipulated penalties may be assessed for each missed deadline as follows:

<u>Period of Noncompliance:</u>	<u>Penalty Per Violation Per Day:</u>
One (1) to fourteen (14) days	\$500
Fifteen (15) to thirty (30) days	\$1,000
Thirty-one (31) to sixty (60) days	\$1,500
Sixty-one (61) to one hundred-eighty (180) days	\$2,000
More than one hundred-eighty (180) days	\$2,500

(d). Failure to Timely Implement SEP Milestones. For each day Miami-Dade fails to Timely implement a SEP milestone set forth in Section VIII (Supplemental Environmental Project) or Appendix E, daily stipulated penalties may be assessed as follows:

<u>Period of Noncompliance:</u>	<u>Penalty Per Violation Per Day:</u>
1 - 30 days	\$1,000
More than 30 days	\$2,000

(e). Failure to Satisfactorily Complete SEP. After receiving the SEP Completion Report, in the event EPA notifies Miami-Dade that Miami-Dade has failed to satisfactorily complete the SEP in accordance with the terms of this Consent Decree as described in Section VIII (Supplemental Environmental Project) and Appendix E (including the allowable expenditures for the SEP), a stipulated penalty of \$850,000 may be assessed if Miami-Dade does not cure the deficiencies identified in EPA's notice within ninety (90) Days after receiving such notice. Notwithstanding the foregoing, if EPA determines that Miami-Dade has made good faith efforts to satisfactorily complete the SEP and has certified, with supporting documentation, that at least ninety (90) percent of the required amount of money has been spent on the SEP, Miami-Dade shall not be liable for any stipulated penalty.

43. Stipulated penalties under this Section shall begin to accrue on the day after performance is due or on the day a violation occurs, whichever is applicable, and shall continue to accrue until performance is satisfactorily completed or until the violation ceases. Stipulated penalties shall accrue simultaneously for separate violations of this Consent Decree.

44. Miami-Dade shall pay stipulated penalties within thirty (30) Days of a written demand. EPA and/or FDEP may seek stipulated penalties under this Section by both sovereigns sending a joint written demand to Miami-Dade, or by either sovereign sending a written demand to Miami-Dade, with a copy simultaneously sent to the other sovereign. The other sovereign has twenty (20) Days from receiving the demand to elect to join in on the demand, except that EPA shall not demand or join in on a demand by FDEP for stipulated penalties that accrue pursuant to Subparagraph 42(a)(v). Either sovereign may waive stipulated penalties or reduce the amount of stipulated penalties it demands, in the unreviewable exercise of its discretion and in accordance

with this Paragraph 44. Where both sovereigns demand stipulated penalties for the same violation of this Consent Decree, Miami-Dade shall pay fifty percent (50%) of the total stipulated penalty amount due to the United States and fifty percent (50%) to FDEP. Where only one sovereign demands stipulated penalties for a violation, and the other sovereign does not join in the demand within twenty (20) Days of receiving the demand, Miami-Dade shall pay the full stipulated penalties due for the violation to the sovereign making the demand. Where both sovereigns demand stipulated penalties for a violation, but only one sovereign subsequently elects to waive or reduce stipulated penalties for that violation, Miami-Dade shall pay the full stipulated penalties due for that sovereign making the full demand less any amount paid to the other sovereign.

45. Stipulated penalties shall continue to accrue as provided in Paragraph 43, during any Dispute Resolution, but need not be paid until the following:

(a). If the dispute is resolved by agreement or by a decision of EPA and/or FDEP that is not appealed to the Court, Miami-Dade shall pay accrued penalties determined to be owing, together with interest, to the United States and/or FDEP within thirty (30) Days of the effective date of the agreement or the receipt of the decision or order.

(b). If the dispute is appealed to the District Court and the United States prevails in whole or in part, Miami-Dade shall pay all accrued penalties determined by the District Court to be owed, together with interest, within sixty (60) Days of receiving the Court's decision or order, except as provided in Subparagraph 45(c), below.

(c). If the District Court's decision is appealed, and the United States and/or FDEP prevails in whole or in part upon appeal, Miami-Dade shall pay all accrued penalties

determined to be owed, together with interest, within fifteen (15) Days of receiving the final Appellate Court decision.

46. Miami-Dade shall pay stipulated penalties owing to the United States in the manner set forth and with the confirmation notices required by Paragraph 21, except that the transmittal letter shall state that the payment is for stipulated penalties and shall state for which violation(s) the penalties are being paid. Miami-Dade shall pay stipulated penalties owing to FDEP in the manner set forth in Paragraph 22.

47. If Miami-Dade fails to pay stipulated penalties according to the terms of this Consent Decree, Miami-Dade shall be liable for interest on such penalties, as provided for in 28 U.S.C. § 1961, accruing as of the date payment became due. Nothing in this Paragraph shall be construed to limit the United States or FDEP from seeking any remedy otherwise provided by law for Miami-Dade's failure to pay any stipulated penalties.

48. Subject to the provisions of Section XV of this Consent Decree (Effect of Settlement/Reservation of Rights), the stipulated penalties provided for in this Consent Decree shall be in addition to any other rights, remedies, or sanctions available to the United States and FDEP for Miami-Dade's violation of this Consent Decree or applicable law.

49. The United States and/or FDEP shall credit Miami-Dade for any stipulated penalty paid to the sovereign with respect to any SSO pursuant to this Consent Decree in any future enforcement action in which that sovereign seeks penalties for that SSO. The United States and/or FDEP shall also credit Miami-Dade against any stipulated penalty assessed for an SSO pursuant to this Consent Decree by the amount of any penalty paid to that sovereign by Miami-Dade for the SSO in any enforcement action.

50. In exercising its discretion of whether to assess a stipulated penalty for an SSO, EPA and/or FDEP will consider the amount of any sewage recovered.

XI. FORCE MAJEURE

51. "Force Majeure," for purposes of this Consent Decree, is defined as any event arising from causes beyond the control of Miami-Dade, of any entity controlled by Miami-Dade, or of Miami-Dade's consultants and contractors that delays or prevents the performance of any obligation under this Consent Decree despite Miami-Dade's best efforts to fulfill the obligation. The requirement that Miami-Dade exercise "best efforts to fulfill the obligation" includes using best efforts to anticipate any potential force majeure event and best efforts to address the effects of any such event (a) as it is occurring and (b) after it has occurred to prevent or minimize any resulting delay to the greatest extent possible. "Force Majeure" does not include Miami-Dade's financial inability to perform any obligation under this Consent Decree. Where any compliance obligation under this Consent Decree requires Miami-Dade to obtain a Federal, State, or local permit or approval, Miami-Dade should submit timely and complete applications and take all other actions required by law to obtain all such permits or approvals. Miami-Dade may seek relief under the provisions of this Section XI of this Consent Decree (Force Majeure) for any delay in the performance of any such obligation resulting from a failure to obtain, or a delay in obtaining, any permit or approval required to fulfill such obligation to the extent that Miami-Dade has submitted timely and complete applications and has taken all other actions required by law to obtain all such permits or approvals.

52. If any event occurs or has occurred that may delay the performance of any obligation under this Consent Decree, whether or not caused by a Force Majeure event, Miami-

Dade shall provide notice orally or by electronic or facsimile transmission to EPA and FDEP as set forth in Section XVII (Notices), within seventy-two (72) hours of when Miami-Dade first knew that the event might cause a delay. Within fourteen (14) Days thereafter, Miami-Dade shall provide in writing to EPA and FDEP an explanation and description of the reasons for the delay; the anticipated duration of the delay; all actions taken or to be taken to prevent or minimize the delay; a schedule for implementation of any measures to be taken to prevent or mitigate the delay or the effect of the delay; Miami-Dade's rationale for attributing such delay to a force majeure event if it intends to assert such a claim; and a statement as to whether, in the opinion of Miami-Dade, such event may cause or contribute to an endangerment to public health, welfare or the environment. Miami-Dade shall include with any notice all available documentation supporting the claim that the delay was attributable to a force majeure event. Failure to comply with the above requirements shall preclude Miami-Dade from asserting any claim of Force Majeure for that event for the period of time of such failure to comply, and for any additional delay caused by such failure. Miami-Dade shall be deemed to know of any circumstance of which Miami-Dade, any entity controlled by Miami-Dade, or Miami-Dade's contractors knew or should have known.

53. If EPA, after a reasonable opportunity for review and comment by FDEP, agrees that the delay or anticipated delay is attributable to a Force Majeure event, the time for performance of the obligations under this Consent Decree that are affected by the Force Majeure event will be extended by EPA, after a reasonable opportunity for review and comment by FDEP, for such time as is necessary to complete those obligations. An extension of the time for performance of the obligations affected by the force majeure event shall not, of itself, extend the

time for performance of any other obligation. EPA will notify Miami-Dade in writing of the length of the extension, if any, for performance of the obligations affected by the Force Majeure event.

54. If EPA, after a reasonable opportunity for review and comment by FDEP, does not agree that the delay or anticipated delay has been or will be caused by a Force Majeure event, EPA will notify Miami-Dade in writing of its decision.

55. If Miami-Dade elects to invoke the dispute resolution procedures set forth in Section XII (Dispute Resolution), it shall do so no later than fifteen (15) Days after receipt of EPA's notice. In any such proceeding, Miami-Dade shall have the burden of demonstrating by a preponderance of the evidence that the delay or anticipated delay has been or will be caused by a Force Majeure event, that the duration of the delay or the extension sought was or will be warranted under the circumstances, that best efforts were exercised to avoid and mitigate the effects of the delay, and that Miami-Dade complied with the requirements of Paragraphs 51 and 52 above. If Miami-Dade carries this burden, the delay at issue shall be deemed not to be a violation by Miami-Dade of the affected obligation of this Consent Decree identified to EPA and the Court.

XII. DISPUTE RESOLUTION

56. Unless otherwise expressly provided for in this Consent Decree, the dispute resolution procedures of this Section shall be the exclusive mechanism to resolve disputes arising under or with respect to this Consent Decree. Miami-Dade's failure to seek resolution of a dispute under this Section shall preclude Miami-Dade from raising any such issue as a defense

to an action by the United States or FDEP to enforce any obligation of Miami-Dade arising under this Consent Decree.

57. Informal Dispute Resolution. Any dispute subject to Dispute Resolution under this Consent Decree shall first be the subject of informal negotiations. The dispute shall be considered to have arisen when Miami-Dade sends the United States a written Notice of Dispute. Such Notice of Dispute shall state clearly the matter in dispute. The period of informal negotiations shall not exceed twenty (20) Days from the date the dispute arises, unless that period is modified by written agreement between the United States and Miami-Dade. The United States shall consult with FDEP during the period of informal negotiations. If the United States and Miami-Dade cannot resolve a dispute by informal negotiations, then the position advanced by the United States shall be considered binding unless, within forty-five (45) Days after the conclusion of the informal negotiation period, Miami-Dade invokes formal dispute resolution procedures as set forth below.

58. Formal Dispute Resolution. Miami-Dade shall invoke formal dispute resolution procedures, within the time period provided in the preceding Paragraph, by serving on the United States and FDEP a written Statement of Position regarding the matter in dispute. The Statement of Position shall include, but need not be limited to, any factual data, analysis, or opinion supporting Miami-Dade's position and any supporting documentation relied upon by Miami-Dade. The United States shall serve its Statement of Position within one hundred (100) Days of receipt of Miami-Dade's Statement of Position. The United States' Statement of Position shall include, but need not be limited to, any factual data, analysis, or opinion supporting that position and any supporting documentation relied upon by the United States. The United States shall

consult with FDEP during preparation of its Statement of Position. The United States' Statement of Position shall be binding on Miami-Dade, unless Miami-Dade files a motion for judicial review of the dispute in accordance with the following Paragraph.

59. Judicial Dispute Resolution. Miami-Dade may seek judicial review of the dispute by filing with the Court and serving on the United States and FDEP, in accordance with Section XVII of this Consent Decree (Notices), a motion requesting judicial resolution of the dispute. The motion must be filed within thirty (30) Days of receipt of the United States' Statement of Position pursuant to the preceding Paragraph. The motion shall contain a written statement of Miami-Dade's position on the matter in dispute, including any supporting factual data, analysis, opinion, or documentation, and shall set forth the relief requested and any schedule within which the dispute must be resolved for orderly implementation of the Consent Decree. The United States shall respond to Miami-Dade's motion within the time period allowed by the Local Rules of this Court. The United States shall consult with FDEP during preparation of its response. Miami-Dade may file a reply memorandum, to the extent permitted by the Local Rules.

60. Standard of Review.

(a). Disputes Concerning Matters Accorded Record Review. Except as otherwise provided in this Consent Decree, in any dispute brought under Paragraphs 58 and 59 pertaining to the adequacy or appropriateness of plans, procedures to implement plans, schedules or any other items requiring approval by EPA under this Consent Decree; the adequacy of the performance of work undertaken pursuant to this Consent Decree; and all other disputes that are accorded review on the administrative record under applicable principles of administrative law,

Miami-Dade shall have the burden of demonstrating, based on the administrative record, that the position of the United States is arbitrary and capricious or otherwise not in accordance with law.

(b). Other Disputes. Except as otherwise provided in this Consent Decree, in any other dispute brought under Paragraphs 58 and 59, Miami-Dade shall bear the burden of demonstrating that its position complies with this Consent Decree and furthers the objectives of the Consent Decree.

61. The invocation of dispute resolution procedures under this Section shall not, by itself, extend, postpone, or affect in any way any obligation of Miami-Dade under this Consent Decree, unless and until final resolution of the dispute so provides. Stipulated penalties with respect to the disputed matter shall continue to accrue from the first day of noncompliance, but payment shall be stayed pending resolution of the dispute as provided in Paragraph 45. If Miami-Dade does not prevail on the disputed issue, stipulated penalties shall be assessed and paid as provided in Section X. (Stipulated Penalties).

XIII. RIGHT OF ENTRY AND INFORMATION COLLECTION AND RETENTION

62. The United States, FDEP, and their representatives, including attorneys, contractors, and consultants, shall have the right of entry into any facility covered by this Consent Decree, at all reasonable times, upon presentation of credentials, to:

- (a). Monitor the progress of activities required under this Consent Decree.
- (b). Verify any data or information submitted to the United States or FDEP in accordance with the terms of this Consent Decree.
- (c). Obtain samples and, upon request, splits of any samples taken by Miami-Dade or its representatives, contractors, or consultants.

- (d). Obtain documentary evidence, including photographs and similar data.
- (e). Assess Miami-Dade's compliance with this Consent Decree.

63. Upon request, Miami-Dade shall provide EPA and FDEP or their authorized representatives splits of any samples taken by Miami-Dade. Upon request, EPA and FDEP shall provide Miami-Dade splits of any samples taken by EPA or FDEP.

64. Until five (5) years after the termination of this Consent Decree, Miami-Dade shall retain, and shall instruct its contractors and agents to preserve, all non-identical copies of all documents, records, or other information (including documents, records, or other information in electronic form) in its or its contractors' or agents' possession or control, or that come into its or its contractors' or agents' possession or control, and that relate in any manner to Miami-Dade's performance of its obligations under this Consent Decree. This information-retention requirement shall apply regardless of any contrary corporate or institutional policies or procedures. At any time during this information-retention period, upon request by the United States or FDEP, Miami-Dade shall provide copies of any documents, records, or other information required to be maintained under this Paragraph.

65. At the conclusion of the information-retention period provided in the preceding Paragraph, Miami-Dade shall notify the United States and FDEP at least ninety (90) Days prior to the destruction of any documents, records, or other information subject to the requirements of the preceding Paragraph and, upon request by the United States or FDEP, Miami-Dade shall deliver any such documents, records, or other information to the United States or FDEP. Miami-Dade may assert that certain documents, records, or other information are privileged under the

attorney-client privilege or any other privilege recognized by federal law. If Miami-Dade asserts such a privilege, it shall provide the following:

- (a). The title of the document, record, or information.
- (b). The date of the document, record, or information.
- (c). The name and title of each author of the document, record, or information.
- (d). The name and title of each addressee and recipient.
- (e). A description of the subject of the document, record, or information.
- (f). The privilege asserted by Miami-Dade.

However, no documents, records, or other information created or generated pursuant to the requirements of this Consent Decree shall be withheld on grounds of privilege.

66. Miami-Dade may also assert that information required to be provided under this Section is protected as Confidential Business Information ("CBI") under 40 C.F.R. Part 2. As to any information that Miami-Dade seeks to protect as CBI, Miami-Dade shall follow the procedures set forth in 40 C.F.R. Part 2.

67. This Consent Decree in no way limits or affects any right of entry and inspection, or any right to obtain information, held by the United States or FDEP pursuant to applicable federal or state laws, regulations, or permits, nor does it limit or affect any duty or obligation of Miami-Dade to maintain documents, records, or other information imposed by applicable federal or state laws, regulations, or permits.

XIV. NOT A PERMIT/COMPLIANCE WITH OTHER STATUTES/REGULATIONS

68. This Consent Decree is not a permit, or a modification of any permit, under any federal, State, or local laws or regulations. Nor shall this Consent Decree in any way relieve

Miami-Dade of its obligation to obtain NPDES and/or Florida permits for its North, Central and South District WWTPs or any other part of its WCTS or facilities. Miami-Dade is responsible for achieving and maintaining complete compliance with all applicable federal, State, and local laws, regulations, and permits including, without limitation, the NPDES and/or Florida Permits for its North, Central and South District WWTPs or any other part of its WCTS facilities; and Miami-Dade's compliance with this Consent Decree shall be no defense to any action commenced pursuant to any such laws, regulations, or permits, except as set forth herein. The United States and FDEP do not, by their consent to the entry of this Consent Decree, warrant or aver in any manner that Miami-Dade's compliance with any aspect of this Consent Decree will result in compliance with provisions of the CWA, Florida law, or with any other provisions of federal, State, or local laws, regulations, or permits.

XV. EFFECT OF SETTLEMENT/RESERVATION OF RIGHTS

69. This Consent Decree resolves the civil claims of the United States, the State and FDEP for the violations alleged in the Complaint filed in this action through the Date of Lodging of this Consent Decree.

70. The United States, the State and FDEP reserve all legal and equitable remedies available to enforce the provisions of this Consent Decree, except as expressly stated in Paragraph 69. This Consent Decree shall not be construed to limit the rights of the United States, the State or FDEP to obtain penalties or injunctive relief under the CWA, Florida law, implementing regulations, or under other federal or state laws, regulations, or permit conditions, except as expressly specified in Paragraph 69. The United States and FDEP further reserve all legal and equitable remedies to address any imminent and substantial endangerment to the public

health or welfare or the environment arising at, or posed by, Miami-Dade's Sewer System, whether related to the violations addressed in this Consent Decree or otherwise.

71. In any subsequent administrative or judicial proceeding initiated by the United States or FDEP for injunctive relief, civil penalties, other appropriate relief relating to the Sewer System or Miami-Dade's violations of the CWA, Florida law, or with any other provisions of federal, State, or local laws, regulations or permits, Miami-Dade shall not assert, and may not maintain, any defense or claim based upon the principles of waiver, res judicata, collateral estoppel, issue preclusion, claim preclusion, claim-splitting, or other defenses, where the defense or claim is based upon any contention that the claims raised by the United States or FDEP in the subsequent proceeding were or should have been brought in the instant case, except with respect to claims that have been specifically resolved pursuant to Paragraph 69 of this Section.

72. This Consent Decree does not limit or affect the rights of Miami-Dade or of the United States, the State, or FDEP against any third parties, not party to this Consent Decree, nor does it limit the rights of third parties, not party to this Consent Decree, against Miami-Dade, except as otherwise provided by law.

73. This Consent Decree shall not be construed to create rights in, or grant any cause of action to, any third party not party to this Consent Decree.

74. Nothing in this Consent Decree limits the rights or defenses available under Section 309(e) of the Clean Water Act, 33 U.S.C. § 1319(e), in the event that the laws of the State, as currently or hereafter enacted, may prevent Miami-Dade from raising revenues needed to comply with this Consent Decree.

XVI. COSTS

75. Except as otherwise provided in Paragraph 76 below, the Parties shall bear their own costs of this action, including attorneys' fees, except that the United States and FDEP shall be entitled to collect the costs (including attorneys' fees) incurred in any action necessary to collect any portion of the civil penalty or any stipulated penalties due but not paid by Miami-Dade.

76. Miami-Dade is currently providing funding to FDEP at the rate of \$55,000 per year to monitor Miami-Dade's compliance with the terms of FDEP Consent Order OGC No.03-1376(A) (hereinafter "FDEP CO"). When Miami-Dade's obligation to fund the FDEP CO ceases, Miami-Dade shall provide funding to FDEP to monitor Miami-Dade's compliance with the terms of this Consent Decree at the rate of \$55,000 per year until this Consent Decree is terminated. However, in no event shall Miami-Dade be obligated to pay more than \$55,000 for any one (1) year period under the terms of either this Consent Decree or the FDEP CO. Within thirty (30) Days of termination of this Consent Decree, FDEP shall return to Miami-Dade any unused funds.

XVII. NOTICES

77. Unless otherwise specified herein, whenever notifications, submissions, or communications are required by this Consent Decree, they shall be made in writing (electronically delivery-receipt requested or by mail return-receipt requested) and addressed as follows:

To the United States:

Chief, Environmental Enforcement Section
Environment and Natural Resources Division
U.S. Department of Justice
P.O. Box 7611
Ben Franklin Station
Washington, D.C. 20044-7611
Re: DOJ No. 90-5-1-1-4022

Rachael Amy Kamons
Environmental Enforcement Section
U.S. Department of Justice
P.O. Box 7611
Ben Franklin Station
Washington, D.C. 20044-7611

and

Chief, Clean Water Enforcement Branch
Water Protection Division
ATTN: Brad Ammons
U.S Environmental Protection Agency, Region 4
61 Forsyth Street, S.W.
Atlanta, GA 30303
(404) 562-9769
ammons.brad@epa.gov

To EPA:

Chief, Clean Water Enforcement Branch
Water Protection Division
ATTN: Brad Ammons
U.S Environmental Protection Agency, Region 4
61 Forsyth Street, S.W.
Atlanta, GA 30303
(404) 562-9769
ammons.brad@epa.gov

To the State:

Jonathan A. Glogau
Special Counsel
Chief, Complex Litigation
Office of the Attorney General
PL-01, The Capitol
Tallahassee, FL 32399-1050
850-414-3817
jon.glogau@myfloridalegal.com

Florida Department of Environmental Protection
Southeast District – Suite 200
400 N. Congress Ave.
West Palm Beach, FL 33401
Attn: Compliance/Enforcement Section

To FDEP:

Florida Department of Environmental Protection
Southeast District – Suite 200
400 N. Congress Ave.
West Palm Beach, FL 33401
Attn: Compliance/Enforcement Section

To Miami-Dade:

County Mayor
111 NW First Street 29th Floor
Miami, Florida 33128

Director
Miami-Dade Water and Sewer Department
3071 SW 38th Avenue
Miami, Florida 33146

County Attorney
111 NW First Street Suite 2810
Miami, Florida 33128

78. Any Party may, by written notice to the other Parties, change its designated notice recipient or notice address provided above.

79. Notices submitted pursuant to this Section shall be deemed submitted upon mailing, or if submitted electronically upon delivery-receipt, unless otherwise provided in this Consent Decree or by mutual agreement of the Parties in writing.

XVIII. DATE OF ENTRY

80. The Date of Entry of this Consent Decree shall be the date upon which this Consent Decree is entered by the Court or a motion to enter the Consent Decree is granted, whichever occurs first, as recorded on the Court's docket. Upon the Date of Entry of this Consent Decree, the First Partial Consent Decree and the Second and Final Partial Consent Decree shall be terminated.

XIX. RETENTION OF JURISDICTION

81. The Court shall retain jurisdiction over this case until termination of this Consent Decree, for the purpose of resolving disputes arising under this Consent Decree or entering orders modifying this Consent Decree, pursuant to Sections XII (Dispute Resolution) and XX (Modification), or effectuating or enforcing compliance with the terms of this Consent Decree.

XX. MODIFICATION

82. The terms of this Consent Decree, including any attached appendices, may be modified only by a subsequent written agreement signed by the United States, FDEP, and Miami-Dade. Where the modification constitutes a material change to this Consent Decree, it shall be effective only upon approval by the Court. Non-material changes to this Consent Decree (including appendices) may be made by written agreement of the United States, FDEP, and Miami-Dade without Court approval, and such parties may by mutual agreement determine whether a modification is non-material.

83. Any disputes between the United States, FDEP, and Miami-Dade concerning modification of this Consent Decree shall be resolved pursuant to Section XII of this Consent Decree (Dispute Resolution), provided, however, that, instead of the burden of proof provided by Paragraph 60, the party seeking the modification bears the burden of demonstrating that it is entitled to the requested modification in accordance with Federal Rule of Civil Procedure 60(b).

XXI. TERMINATION

84. This Consent Decree may be terminated when the United States determines that Miami-Dade has satisfactorily completed performance of its compliance (Section VI) and SEP (Section VIII) obligations required by this Consent Decree, provided that Miami-Dade has fulfilled all other obligations of this Consent Decree, including payment of the civil penalty under Section VII of this Consent Decree and any accrued stipulated penalties as required by Section X of this Consent Decree not waived or reduced by the United States. Miami-Dade may serve upon the United States a Request for Termination, certifying that Miami-Dade has satisfied those requirements, together with all necessary supporting documentation.

85. Following receipt by the United States of Miami-Dade's Request for Termination, the United States and Miami-Dade shall confer informally concerning the Request and any disagreement that they may have as to whether Miami-Dade has satisfactorily complied with the requirements for termination of this Consent Decree. If the United States, after consultation with FDEP, agrees that this Consent Decree may be terminated, the United States and Miami-Dade shall submit, for the Court's approval, a joint stipulation terminating the Consent Decree.

86. If the United States, after consultation with FDEP, does not agree that this Consent Decree may be terminated, Miami-Dade may invoke Dispute Resolution under Section

XII of this Consent Decree. However, Miami-Dade shall not seek Dispute Resolution of any dispute regarding termination, under Paragraph 58 of Section XII (Dispute Resolution), until one hundred-twenty (120) Days after service of its Request for Termination.

XXII. PUBLIC PARTICIPATION

87. This Consent Decree shall be lodged with the Court for a period of not less than thirty (30) Days for public notice and comment in accordance with 28 C.F.R. § 50.7. The United States, the State and FDEP each reserve the right to withdraw or withhold its consent if the comments regarding the Consent Decree disclose facts or considerations indicating that the Consent Decree is inappropriate, improper, or inadequate. Miami-Dade consents to entry of this Consent Decree without further notice and agrees not to withdraw from or oppose entry of this Consent Decree by the Court or to challenge any provision of the Consent Decree, unless the United States, the State or FDEP has notified the Parties in writing that it no longer supports entry of the Consent Decree.

XXIII. SIGNATORIES/SERVICE

88. Each undersigned representative of Miami-Dade, the United States, the State, and FDEP certifies that he or she is fully authorized to enter into the terms and conditions of this Consent Decree and to execute and legally bind the Party he or she represents to this document.

89. This Consent Decree may be signed in counterparts, and its validity shall not be challenged on that basis. Miami-Dade agrees to accept service of process by mail and/or e-mail with respect to all matters arising under or relating to this Consent Decree and to waive the formal service requirements set forth in Rules 4 and 5 of the Federal Rules of Civil Procedure and any applicable Local Rules of this Court including, but not limited to, service of a summons.

XXIV. INTEGRATION

90. This Consent Decree constitutes the final, complete, and exclusive agreement and understanding among the Parties with respect to the settlement embodied in this Consent Decree and supersedes all prior agreements and understandings, whether oral or written, concerning the settlement embodied herein. Prior drafts of this Consent Decree shall not be used in any action involving the interpretation or enforcement of this Consent Decree. Other than Deliverables that are subsequently submitted and approved pursuant to this Consent Decree, no other document, nor any representation, inducement, agreement, understanding, or promise, constitutes any part of this Consent Decree or the settlement it represents, nor shall it be used in construing the terms of this Consent Decree.

XXV. FINAL JUDGMENT

91. Upon approval and entry of this Consent Decree by the Court, this Consent Decree shall constitute a final judgment of the Court as to the United States, the State, FDEP, and Miami-Dade. The Court finds that there is no just reason for delay and therefore enters this judgment as a final judgment under Fed. R. Civ. P. 54 and 58.

XXVI. APPENDICES

92. The following appendices are attached to and part of this Consent Decree:
- “Appendix A” is the Adequate Treatment and Transmission Capacity Criteria;
 - “Appendix B” is the Volume Sewer Customer Ordinance Program Implementation;
 - “Appendix C” is the US EPA Region IV CMOM guidance;
 - “Appendix D” is the Work Plan for Specific Capital Improvement Projects; and

“Appendix E” is the description of the Supplemental Environmental Project.

Dated and entered this ___ day of _____, _____.

[]
UNITED STATES DISTRICT JUDGE
Southern District of Florida

WE HEREBY CONSENT to the entry of this Consent Decree, subject to the public notice and comment provisions of 28 C.F.R. § 50.7:

FOR PLAINTIFF UNITED STATES OF AMERICA:

IGNACIA S. MORENO
Assistant Attorney General
U.S. Department of Justice
Environment and Natural Resources Division

RACHAEL AMY KAMONS
Trial Attorney
U.S. Department of Justice
Environment and Natural Resources Division
Environmental Enforcement Section
P.O. Box 7611
Ben Franklin Station
Washington, D.C. 20044-7611
Telephone: 202-514-5260
Facsimile: 202-616-2427
rachael.kamons@usdoj.gov

WIFREDO A. FERRER
United States Attorney
Southern District of Florida

WE HEREBY CONSENT to the entry of this Consent Decree, subject to the public notice and comment provisions of 28 C.F.R. § 50.7:

FOR PLAINTIFF UNITED STATES OF AMERICA (Continued):

V. ANNE HEARD
Acting Regional Counsel
United States Environmental Protection Agency
Region 4

WILLIAM B. BUSH, JR.
Associate Regional Counsel
United States Environmental Protection Agency
Region 4
61 Forsyth Street
Atlanta, GA 30303
Telephone: 404-562-9538
Facsimile: 404-562-9486
bush.william@epa.gov

WE HEREBY CONSENT to the entry of this Consent Decree, subject to the public notice and comment provisions of 28 C.F.R. § 50.7:

FOR PLAINTIFF UNITED STATES OF AMERICA (Continued):

CYNTHIA GILES
Assistant Administrator
Office of Enforcement and Compliance Assurance
United States Environmental Protection Agency

SUSAN SHINKMAN
Office Director
Office of Civil Enforcement
Office of Enforcement and Compliance Assurance
United States Environmental Protection Agency

MARK POLLINS
Division Director
Water Enforcement Division
Office of Civil Enforcement
Office of Enforcement and Compliance Assurance
United States Environmental Protection Agency

ALAN MORRISSEY
Senior Attorney
Water Enforcement Division
Office of Civil Enforcement
Office of Enforcement and Compliance Assurance
United States Environmental Protection Agency
1200 Pennsylvania Ave., NW (2243A)
Washington, DC 20460
Telephone: 202-564-4026
Facsimile: 202-564-0024
morrissey.alan@epa.gov

**FOR PLAINTIFF STATE OF FLORIDA DEPARTMENT
OF ENVIRONMENTAL PROTECTION:**

JEFF LITTLEJOHN, P.E.
Deputy Secretary for Regulatory Programs
Florida Department of Environmental Protection
Douglas Building
3900 Commonwealth Blvd
Tallahassee, Florida 32399-3000
Telephone: 850-245-2037
Facsimile: 850-245-2147

FOR PLAINTIFF STATE OF FLORIDA:

PAMELA JO BONDI
Attorney General

JONATHAN A. GLOGAU
Florida Bar Number 371823
Special Counsel
Chief, Complex Litigation
Office of the Attorney General
PL-01, The Capitol
Tallahassee, FL 32399-1050
Telephone: 850-414-3300, ext. 4817
Facsimile: 850-414-9650
jon.glogau@myfloridalegal.com

FOR DEFENDANT MIAMI-DADE COUNTY, a political subdivision of the State of Florida:

THE HONORABLE CARLOS A. GIMENEZ
Mayor
Miami-Dade County

R.A. CUEVAS, JR.
Miami-Dade County Attorney

HENRY N. GILLMAN
Florida Bar Number 793647
Assistant County Attorney
111 NW 1st Street Suite 2810
Miami, Florida 33128
Telephone: 305-375-2149
Facsimile: 305-375-5611
hgill@miamidade.gov

APPENDIX A

APPENDIX A

Adequate Pumping, Transmission and Treatment Capacity Program Criteria

(A). Definitions. Whenever the terms set forth below are used in this Appendix, the following definitions shall apply:

(i). High Annual Monthly Average (“HAMA”) shall mean the largest value within the last twelve (12) Months of the monthly daily average pump operating time for each Pump Station. Miami-Dade will be granted one exemption per twelve (12)-Month period for any monthly average exceeding the fifteen (15) hours per day if the high hours were caused by a maintenance problem that has been addressed and resolved.

(ii). Sewer Extension shall mean any sewer project that requires either a general or individual construction permit as defined by the current edition of Chapter 62-604 of the Florida Administrative Code.

(iii). Yearly Nominal Daily Average Pump Operating Time (“NAPOT”) for each Pump Station shall be defined as the average of daily average pump operating time for all Months falling within the previous 365 days, divided by one less than the total number of pumps installed in that station. The pump hours shall be based on metered running time or derived from power used by station pump motors. As an alternative to the elapsed running time meters on the pumps in a Pump Station, the monthly average daily pump operating hours for Pump Stations with multi-speed and variable speed pumps may be determined based on the average power consumption of the pumps in the station over the previous reporting period. For multi-speed Pump Stations, the station shall be determined to have a monthly daily average pump operating time value of 10.00 hours per day if the power usage for the previous month was equal to forty-six percent (46%) of the power that would be used by all of the station pumps but one running at

full rated power for the reporting period. The actual monthly daily average pump operating time value will be determined on a linear proportional basis from the actual power used by the pumps during the previous month. For stations with variable speed pumps, the equivalent daily average pump operating time shall be determined based on the power used and the type of variable speed drive as follows:

(a). For Pump Stations driven by variable frequency drives, the equivalent 10.00 hours per day monthly daily average pump operating time shall be reached when the Pump Station uses in one Month forty-nine percent (49%) of the power used by all of the station pumps but one running at full rated power for the reporting period.

(b). For Pump Stations driven by magnetic variable speed drives, the equivalent 10.00 hours per day monthly daily average pump operating time shall be reached when the Pump Station uses in one Month sixty-five percent (65%) of the power used by all of the station pumps but one running at full rated power for the reporting period.

(c). For Pump Stations driven by resistor bank variable speed drives, the equivalent 10.00 hours per day monthly daily average pump operating time shall be reached when the Pump Station uses in one Month sixty-one percent (61%) of the power used by all of the station pumps but one running at full rated power for the reporting period.

(iv). Yearly Projected Nominal Daily Average Pump Station Operating Time ("Projected NAPOT") shall be defined as the Yearly Nominal Daily Average Pump Operating Time plus the calculated additional operating hours expected as a result of all anticipated sewage flow resulting from all previously authorized additional sewer flows.

(B). Additional Sewer Flows Authorization. Miami Dade shall authorize only those additional sewer flows in accordance with the Code of Miami-Dade, as amended, and as provided for below:

(i). No Miami-Dade or municipal officer, agent, employee, or board shall approve, grant or issue any building permit, certificate of use and occupancy (except for changes in ownership) or Local Business Tax Receipt (LBTR), municipal occupational license (except for changes in ownership) for any land use served or to be served by a publicly or privately owned or operated sanitary sewer collection system prior to obtaining a sanitary sewer certification of adequate capacity. A sanitary sewer certification of adequate capacity shall be issued after demonstrating that the receiving collection and transmission system, and the treatment plant(s), have adequate capacity, as defined herein, to handle the additional flow. The sanitary sewer certification of adequate capacity is subject to the following conditions:

(a). When associated with a building permit or other permit that authorizes construction (herein collectively "a construction permit"):

(1). A sanitary sewer certification of adequate capacity obtained prior to an application (including applicable forms and plans) for a construction permit being submitted shall expire and be null and void and be of no further force and effect unless an application for a construction permit is submitted and a process number obtained from the building department or permit issuing department within ninety (90) days from the date of the sanitary sewer certification of adequate capacity is issued. If an application for building permit is submitted, the sanitary sewer certification of adequate capacity shall thereafter expire in accordance with subparagraphs (B)(i)(a)(2) and (3) below.

(2). A sanitary sewer certification of adequate capacity obtained subsequent to an application (including applicable forms and plans) for a construction permit being submitted shall expire and be null and void and be of no further force and effect when the application for the construction permit expires.

(3). When a construction permit is issued with a sanitary sewer certification of adequate capacity, the sanitary sewer certification of adequate capacity shall expire and be null and void and be of no further force and effect within one hundred-fifty (150) days of the construction permit expiration unless said permit is renewed or replaced.

In all other events, the sanitary sewer certification of adequate capacity shall expire after one hundred-eighty (180) days or upon the issuance of the certificate of use or certificate of occupancy or other use authorization.

(C). Adequate Treatment Capacity Criteria. Adequate treatment capacity shall be demonstrated by Miami-Dade's certification that the WWTP that will receive flow from newly authorized additional sewer flow will not be in "non-compliance" as defined in 40 C.F.R. Part 123.45, App. A, at the time the WWTP receives the flow from the newly authorized additional sewer flow.

(D). Adequate Transmission Capacity Criteria. Adequate transmission capacity shall mean that each Pump Station receiving the additional sewer flow, and all Pump Stations through which such sewage flow is transmitted to the WWTP receiving the flow, is operating with a Projected NAPOT equal to or less than ten (10) hours per day. If the above condition is not met by a booster type station, the station will be considered to have adequate transmission capacity if so determined by a peak capacity study conducted by Miami-Dade that takes into consideration

adjacent Pump Stations and downstream force mains. Transmission capacity certifications authorizing additional sewer flows shall be issued according to the following criteria:

(i). For projects with an existing connection to sewers or connecting to an existing collection system and therefore not requiring a sewer extension permit in the public right of way:

(a). If there is adequate transmission capacity, as defined in subparagraph (A)(iii) above, for all Pump Stations through which sewage flow from the sewer service connection is transmitted to the wastewater treatment facility receiving such sewage flow, certification can be granted without restrictions, or

(b). If adequate transmission capacity does not exist, as defined in subparagraph (A)(iii) above, unrestricted certification can be granted only if all of the following conditions are met for all Pump Stations through which sewage flow from the sewer service connection is transmitted to the wastewater treatment facility receiving such sewage flow:

(1). The proposed flows will cause an increase equal to or less than 0.5 hours per day to the Projected NAPOT and,

(2). after including the additional proposed flows, the Projected NAPOT will be equal to or less than twelve (12) hours per day and,

(3). the additional proposed flows are less than 10,000 GPD and,

(4). the Pump Station is not out of compliance due to sanitary sewer overflows.

(ii). For projects requiring a sewer extension in the public right-of-way within an existing Pump Station basin:

(a). If adequate transmission capacity exists at the Pump Station and all Pump Stations through which sewage flow from the sewer service connection is transmitted to the WWTP receiving such sewage flow, certification can be granted without restrictions only if:

(1). the new project Average Daily Flow is equal to or less than 1,000 GPD or,

(2). the HAMA for all Pump Stations through which sewage flow from the sewer service connection is transmitted to the WWTP receiving such sewage flow is equal to or less than fifteen (15) hours per day or,

(3). the HAMA for any Pump Stations through which sewage flow from the sewer service connection is transmitted to the WWTP receiving such sewage flow is greater than fifteen (15) hours per day but a peak capacity study conducted by Miami Dade, that takes into consideration adjacent Pump Stations and downstream force mains, has determined that the new flows can be accommodated without any upgrades to the system and no sanitary sewer overflows have occurred in the station's basin within the previous twelve (12) months;

(b). If adequate transmission capacity exists but the HAMA is greater than fifteen (15) hours per day for any Pump Stations through which sewage flow from the sewer service connection is transmitted to the WWTP receiving such sewage flow and a peak capacity study conducted by Miami Dade, that takes into consideration adjacent Pump Stations and downstream force mains, has determined that the new flows can only be accommodated after the system has been upgraded and/or one or more sanitary sewer overflows of 1,000 gallons or more have occurred in last twelve (12) months, certifications will be conditioned to:

(1). Completion of the required upgrade and/or

(2). Implementation of measures to prevent the reoccurrence of sanitary sewer overflows.

(iii). For projects requiring a new collection system, Pump Station and Force Main, a peak capacity study conducted by Miami Dade, that takes into consideration adjacent Pump Stations and downstream force mains, will determine under what conditions the new system is allowed to connect to the Miami-Dade's transmission system.

(E). SSO Criteria. Notwithstanding Miami-Dade's ability to demonstrate capacity in accordance with the terms and conditions of paragraphs (C) and (D) above, Miami-Dade shall not authorize any additional sewer flows to the collection system if:

(i). SSOs have occurred in the receiving Pump Station's basin or in a Force Main that is required to receive the flow from the Pump Station that fall under the following criteria:

(a). There is a reported SSO of 1,000 gallons or more, or a reported SSO that reaches surface water, in the station's collection basin caused by a lack of capacity in the collection piping or the Pump Station, until the capacity of the system is changed to prevent a future overflow.

(b). There are two or more reported SSOs of 1,000 gallons or more each, or two or more reported SSOs that reach surface water, within the last twelve (12) Months caused by blockages in the collection piping for the Pump Station, until a remedial plan directed at preventing the reoccurrence of these overflows has been implemented. Notwithstanding the foregoing, additional sewer flows may be allowed if the receiving portion of the collection system is not located upstream from those areas of the collection system that have experienced five (5) or more SSOs due to blockages within the previous twelve (12) Months.

(c). There are two or more SSOs of 1,000 gallons or more each, or two or more reported SSOs that reach surface water, within the last twelve (12) Months in a force Main required to receive the flow from the Pump Station due to failure of the Force Main pipe, until a remedial plan directed at preventing the reoccurrence of these overflows has been implemented. SSOs caused by contractor activities will not be considered for this item.

(ii). The newly authorized sewer service connection may reasonably be expected to cause Miami-Dade to violate the effluent limitations in the NPDES permit for the WWTP that will receive the flow from the newly authorized sewer service connection; or

(iii). The WWTP that will receive flow from the newly authorized sewer service connection is in "non-compliance" as defined in 40 C.F.R. Part 123.45, App. A.

(F). Adequate Transmission and Treatment Capacity Certification Report. Miami-Dade shall certify on a monthly schedule that adequate transmission and treatment capacity exists until the termination of this Consent Decree. Miami-Dade shall certify that adequate transmission and treatment capacity exists (as defined in this Appendix) to receive flow for each newly authorized sewer service connection, and shall prepare on a monthly basis in an electronic file a summary report which identifies each newly authorized certification of available capacity, and which shall include, at a minimum, the following information:

(i). The date of approval of the newly authorized certification of available capacity.

(ii). The address and the precise point of discharge to the collection system of the newly authorized certification of available capacity.

(iii). The estimated volume of wastewater projected to be discharged from the newly authorized certification of available capacity.

- (iv). The estimated date of issuance of a certificate of occupancy;
- (v). The actual date of the issuance of the certificate of occupancy;
- (vi). The identity and location of the Pump Station immediately downstream from the newly authorized certification of available capacity.
- (vii). The description of the source or use (*e.g.* restaurant, dwelling unit) for the newly authorized certification of available capacity.
- (viii). Whether the issuance of a building permit was dependent on a collection system improvement.

(G). Pump Station Operating Time Report. Miami Dade shall certify on a monthly basis, the following information as to each of the collection system Pump Stations:

- (i). Pump Station number.
- (ii). Pump Station location.
- (iii). NAPOT for the previous 365 days.
- (iv). Projected NAPOT based upon accumulated authorized flows.
- (v). HAMA for the previous 365 days.

(H). Remedial Action Plan Requirement. Where the certification required by paragraph (G) above indicates that Miami Dade's Pump Station(s)' NAPOT (actual or projected) exceeds the capacity criteria set forth in paragraphs (C), (D) and (E) above:

- (i). Miami-Dade shall prepare, within thirty (30) days of the certification required by paragraph (G) above, a remedial action plan that sets forth a program that will ensure adequate transmission capacity, and provide a schedule for completion of that program.
- (ii). When a Pump Station has been reported as having inadequate capacity, and a remedial action plan has been provided, conditional flow allocations may be made to the Pump

Station with the condition that no certificate of occupancy or use may be issued for the facility until Miami Dade or the VSC has certified that the proposed remedial action plan has been completed.

(iii). When a remedial action plan for a Pump Station has been certified as complete by Miami-Dade or the VSC, the Pump Station will be monitored for one (1) year. If, during this period, the most recent monthly report of station operating hours is less than ten (10) hours per day, the station will be listed as having adequate capacity. If, during this period, the most recent monthly report of station operating hours is greater than ten (10) hours per day, the station will be listed as not having adequate capacity. If it is shown at the end of this period that the remedial action plan has not provided a remedy to the condition causing the station to be listed as having inadequate capacity, the station will again be listed as having inadequate capacity. In this event, no additional sewer flows shall be authorized, and no building permit(s) shall be issued, until adequate treatment and transmission capacity can be demonstrated as specified in paragraphs (C), (D) and (E) above. Pump Stations or portions of a collection system that are out of compliance due to SSOs will also be monitored for one (1) year after completion of a remedial action plan. If within this period, the station experiences one (1) SSO of 1,000 gallons or more, or that reaches surface water, the station will again be listed as having inadequate capacity. In this event, no additional sewer flows shall be authorized, and no building permit(s) shall be issued, until adequate treatment and transmission capacity can be demonstrated as specified in paragraphs (C), (D) and (E) above.

(I). Exemption. Notwithstanding the terms and conditions of paragraphs (B), (C), (D) and (E) above, Miami-Dade may authorize new additional sewer flows without the required certifications of adequate treatment and transmission capacity in those cases where a pollution or

sanitary nuisance condition exists as the result of the discharge of untreated wastewater from an on-site septic tank. Miami-Dade shall authorize such connections only after:

(i). Miami Dade has verified and documented the existence of the pollution or sanitary nuisance condition; and

(ii). Miami Dade has documented the nature of the nuisance condition, and the address and the precise point of the discharge to the collection system.

APPENDIX B

APPENDIX B

Volume Sewer Customer Ordinance Program Implementation

(A). Every Volume Sewer Customer (“VSC”) shall specifically be required to comply with EPA documents for the capacity, management, operation, and maintenance of the VSC collection and transmission systems including EPA 305-B-05-002, *Guide for Evaluating Capacity, Management, Operation and Maintenance (CMOM) Programs at Sanitary Sewer Collection Systems*, and *EPA Region 4 Guide to Collection and Transmission System Management, Operation and Maintenance Programs, Version 1.1, or the latest version*.

(B). Within six (6) Months after all modifications to the VSC Ordinance have been made as described in subparagraph 18(e) of this Consent Decree, each VSC shall provide a detailed plan (“Plan of Compliance”) to Miami-Dade for complying with the requirements described in subparagraphs 18(e)(ii) and (iii) of this Consent Decree. Within sixty (60) Days of receipt of Miami-Dade’s comments on the submittal of the Plan of Compliance, the VSC shall make the corrections required by Miami-Dade and resubmit the required plan to Miami-Dade. If the resubmittal is again disapproved by Miami-Dade, the VSC shall have thirty (30) Days upon notification of the disapproval to make the required corrections and resubmit the Plan of Compliance to Miami-Dade. Upon approval of the resubmitted documents, or upon approval of the initial submittal, the VSC shall immediately commence to implement the actions described in the Plan of Compliance according to the time periods provided below. If the VSC does not provide the required documents within the times noted, or if the second resubmittal is determined to be inadequate, or the VSC does not implement the actions proposed in a timely manner, the VSC shall be determined to be nonresponsive. Miami-Dade shall not issue any certification of

adequate capacity for new sanitary sewer flow for any facility served by a VSC determined to be nonresponsive.

(C). The VSC shall comply with the requirements of subparagraph 18(e)(iii) according to the following schedule:

(a). 18(e)(iii)(A). **Sewer Overflow Response Plan:** The written part of the overflow plan shall be delivered as a part of the Plan of Compliance. The training required for this section shall be completed within six (6) months of the approval of the Plan of Compliance. The records program required for this section shall be completed within six (6) Months of the approval of the Plan of Compliance. The rain event inspection routes required for this section shall be created within six (6) Months of the approval of the Plan of Compliance.

(b). 18(e)(iii)(B). **Information Management System Program:** The required information management system program shall be implemented within one (1) year of the approval of the Plan of Compliance.

(c). 18.(e)(iii)(C). **Sewer System Asset Management Plan:** The identification of critical assets, the determination of life cycle costs, and the statement of level of service shall be included in the Plan of Compliance. The long term funding plan shall be provided within one year of Plan of Compliance.

(d). 18(e)(iii)(D). **Gravity Sewer System Operation and Maintenance Program:** The schedules of inspections and preventative maintenance actions shall be provided with the Plan of Compliance. The initial inspections and identification of maintenance needs shall be completed within one year of the approval of the Plan of Compliance. The engineering evaluation of required corrosion controls shall be completed within one (1) year of the approval of the Plan of Compliance. The prioritization for evaluation

of the gravity sewers shall be completed within six (6) Months of the approval of the Plan of Compliance. The staffing requirements for the collection system operations and maintenance shall be met within six (6) Months of the approval of the Plan of Compliance.

(e). 18(e)(iii)(E). **Pump Station Operations and Preventative Maintenance Program:** The identification of means of internal communications, the technical specifications for each Pump Station, a description of the monitoring and control system for each Pump Station, and written preventative operations and maintenance schedules shall be provided with the Plan of Compliance. The listing of required resource commitments including staffing, contractual support and equipment shall be provided within six (6) Months of the approval of the Plan of Compliance. The written standard emergency operations and maintenance procedures shall be provided with the Plan of Compliance.

(f). 18(e)(iii)(F). **Force Main Operations, Preventative Maintenance and Assessment/Rehabilitation Program:** The standard procedures for the assessment of Force Mains and procedures for the repair, replacement, and rehabilitation of Force Mains shall be provided with the Plan of Compliance. The assessment of the Force Mains in the collection and transmission system shall be completed within six (6) Months of the approval of the Plan of Compliance. The assessment of the Force Main easements and a schedule for maintenance of the easements shall be completed within six (6) Months of the approval of the Plan of Compliance. All of the Force Main deficiencies discovered in the initial inspection shall be remedied within five (5) years of the approval of the Plan of Compliance.

(g). **General:** All of the staffing requirements not otherwise noted shall be satisfied within twelve (12) Months of the approval of the Plan of Compliance. All

requirements of Paragraph 18(c) not otherwise designated shall be satisfied within twelve (12) Months of the approval of the Plan of Compliance.

(D). Starting two (2) years after the Effective Date of the Consent Decree each VSC shall provide, by January 31 of each year, a report describing what changes have been determined to be necessary to update the VSC's CMOM program for the upcoming year. The report shall include, at a minimum, the current staffing level in all positions, new work required to maintain the VSC's collection and transmission system, new capital work identified in the previous year, training carried out during the previous year, SSOs from the system during the previous calendar year, and corrective actions for the SSOs, Pump Stations determined to have inadequate capacity during the previous calendar year, and the corrective plans for those Pump Stations.

APPENDIX C



**GUIDE FOR EVALUATING CAPACITY,
MANAGEMENT, OPERATION, AND
MAINTENANCE (CMOM) PROGRAMS
AT SANITARY SEWER COLLECTION
SYSTEMS**

United States
Environmental Protection
Agency

Office of Enforcement and
Compliance Assurance (2224A)

EPA 305-B-05-002

www.epa.gov

January 2005

TABLE OF CONTENTS

1.	Introduction	1-1
1.1	Purpose of This Guide	1-1
1.2	Terminology	1-1
1.3	How to Use the Guide	1-2
1.4	Overview of Underlying Issues	1-3
1.5	Purpose of CMOM Programs	1-4
1.6	National Pollutant Discharge Elimination System Regulatory Requirement	1-5
1.7	EPA Region 4 MOM Programs Project	1-6
2.	Collection System Capacity, Management, Operation, and Maintenance Programs	2-1
2.1	Collection System Management	2-4
2.1.1	Organizational Structure	2-4
2.1.2	Training	2-10
2.1.3	Internal Communication	2-11
2.1.4	Customer Service	2-11
2.1.5	Management Information Systems	2-13
2.1.6	SSO Notification Program	2-14
2.1.7	Legal Authority	2-15
2.2	Collection System Operation	2-17
2.2.1	Budgeting	2-18
2.2.2	Monitoring	2-19
2.2.3	Hydrogen Sulfide Monitoring and Control	2-20
2.2.4	Safety	2-21
2.2.5	Emergency Preparedness and Response	2-22
2.2.6	Modeling	2-24
2.2.7	Mapping	2-25
2.2.8	New Construction	2-26
2.2.9	Pump Stations	2-26
2.3	Equipment and Collection System Maintenance	2-27
2.3.1	Maintenance Budgeting	2-28
2.3.2	Planned and Unplanned Maintenance	2-28
2.3.3	Sewer Cleaning	2-33
2.3.4	Parts and Equipment Inventory	2-35
2.4	Sewer System Capacity Evaluation - Testing and Inspection	2-36
2.4.1	Flow Monitoring	2-37
2.4.2	Sewer System Testing	2-38
2.4.3	Sewer System Inspection	2-39
2.5	Sewer System Rehabilitation	2-41

**3.0 Checklist for Conducting Evaluations of Wastewater Collection System
Capacity, Management, Operation, and Maintenance (CMOM)
Programs 3-1**

**Appendix A Example Collection System Performance Indicator Data
Collection Form A-1**

Appendix B Example Interview Schedule and Topics B-1

Appendix C Information Sources C-1

References R-1

CHAPTER 1. INTRODUCTION

1.1 Purpose of this Guide

This guide identifies some of the criteria used by EPA to evaluate a collection system's management, operation, and maintenance (CMOM) program activities. The guide is intended for use by EPA and state inspectors as well as the regulated community – owners or operators of sewer systems collecting domestic sewage as well as consultants or other third-party evaluators or compliance assistance providers. Collection system owners or operators can review their own systems by following the checklist in Chapter 3 to reduce the occurrence of sewer overflows and improve or maintain compliance. The guidance herein may also be taken a step further. If a federal or state reviewer observes a practice that does not effectively meet the elements of a CMOM program, he or she may make recommendations to educate the operator, inspector, case developer, or those involved in a settlement agreement. Additionally, having key board members (policy makers) read this guide will also allow them to better understand the benefits of investing in good CMOM programs.

The guide is applicable to small, medium, and large systems; both publicly and privately owned systems; and both regional and satellite collection systems. Regardless of size, each owner or operator will have an organization and practices unique to its collection system. While these specific characteristics will vary among systems, the CMOM concepts and best management practices are likely to apply to all types of systems. Where appropriate, this document provides guidance on the differences.

This document does not, however, substitute for the CWA or EPA's regulations, nor is it a regulation itself. Thus, the document does not and cannot impose legally binding requirements upon these circumstances. EPA and state decision-makers retain the discretion to adopt approaches on a case-by-case basis that differ from this guidance where appropriate. EPA may change this guidance in the future.

Individuals reviewing a collection system are strongly encouraged to read the guidance portion of this document prior to conducting a review. Reviewers should use the checklist in Chapter 3 as the primary tool for questions during the paperwork and/or onsite review of the collection system.

While some sections or topics may not appear to relate directly to environmental performance, taken as a whole, they provide an indication of how well the utility is run.

1.2 Terminology

To provide a more user-friendly guidance and for clarification, the terminology for several terms has been modified. The following paragraphs list these terms and reasoning for the modifications.

Frequently, the term "COLLECTION SYSTEM OWNER OR OPERATOR", abbreviated as "OWNER OR OPERATOR," is used in this guide and refers to the entities responsible for the administration and oversight of the sewer system and its associated staff (in either a municipal or industrial context); capacity evaluation, management, operation, and maintenance programs; equipment; and facilities. The owner and operator may be two different entities. For example, the owner may own the infrastructure and be responsible for its maintenance while it designates responsibility for the day to day operation of

the system to the operator. It should be noted that the term used in EPA's CMOM Program Self Assessment Checklist is "MUNICIPAL WASTEWATER UTILITY OPERATORS" or "UTILITY" rather than "collection system owner or operator." Both refer to the same individual(s). The term "REVIEW" is used in this document in place of "INSPECTION" or "AUDIT." Because "inspection" often refers to an evaluation conducted by the regulatory authority and "audit" has been used to refer to an evaluation with very specific requirements, "review" is more appropriately used to capture the wider universe of evaluations (e.g., those conducted by a regulatory authority, the system itself, and/or by a third-party).

Similarly, the term used to describe the person conducting the CMOM review is the "REVIEWER" -- this could be either an inspector, a third party reviewer hired by the owner or operator, or personnel of the owner or operator performing a self-evaluation of the collection system.

The term "FACILITY" is used in this document to refer to the components of the collection system (e.g., pump stations, sewer lines).

1.3 How to Use the Guide

The guide and checklist provide a three-tiered approach to the CMOM review:

- Evaluation of the CMOM program, based on interviews with management and field personnel, as well as observation of routine activities and functions
- Review of pertinent records and information management systems
- Evaluation based on field/site review

Chapter 2 provides a breakdown and overview of each CMOM concept and what to look for when reviewing the system, defines the CMOM elements for the reviewer, and follows through with a discussion of the indicators or other clues about which the reviewer should be aware. Chapters 2 and 3 present detailed information on conducting reviews of collection systems. Chapter 3 contains the comprehensive reviewer checklist, supported by the information in Chapter 2. Appendix A presents a Collection System Performance Indicator Data Collection Form which provides examples of the types of information a reviewer should attempt to obtain while on-site.

The "one size does not fit all" approach to reviewing CMOM programs cannot be overstated. The principles covered in this guide are applicable to all wastewater collection systems, however, these principles may be implemented through different means depending on the system. Larger systems may have the resources and the need to implement more costly and complex means of meeting the CMOM program elements. In occasional cases a CMOM feature may not be implemented at all, due to characteristics of the system. A reviewer should be able to look at the system as a whole and determine whether certain key elements are present or should be present and to what extent the system incorporates the CMOM principles.

Reviewers will also find that the location or names of some documents, logs, or reports may vary from system to system. This guide tries to provide a general description of the materials the reviewer should request.

Although use of this guide cannot guarantee a collection system will avoid permit violations or discharge violations, generally, when owners or operators adequately practice the principles laid out in the guide, they should experience fewer problems and, therefore, fewer instances of noncompliance.

1.4 Overview of the Underlying Issues

Sanitary sewer collection systems are designed to remove wastewater from homes and other buildings and convey it to a wastewater treatment plant. The collection system is a critical element in the successful performance of the wastewater treatment process. EPA estimates that collection systems in the U.S. have a total replacement value between \$1 to \$2 trillion. Under certain conditions, poorly designed, built, managed, operated, and/or maintained systems can pose risks to public health, the environment, or both. These risks arise from sanitary sewer overflows (SSOs) from the collection system or by compromised performance of the wastewater treatment plant. Effective and continuous management, operation, and maintenance, as well as ensuring adequate capacity and rehabilitation when necessary, are critical to maintaining collection system capacity and performance while extending the life of the system.

EPA believes that every sanitary sewer system has the capacity to have an SSO. This may be due to a number of factors including, but not limited to:

- Blockages
- Structural, mechanical, or electrical failures
- Collapsed or broken sewer pipes
- Insufficient conveyance capacity
- Vandalism

Additionally, high levels of inflow and infiltration (I/I) during wet weather can cause SSOs. Many collection systems that were designed according to industry standards experience wet weather SSOs because levels of I/I may exceed levels originally expected; prevention of I/I has proven more difficult and costly than anticipated; or the capacity of the system has become inadequate due to an increase in service population without corresponding system upgrades (EPA 2004).



SSOs include untreated discharges from sanitary sewer systems that reach waters of the United States (photo: US EPA).

SSOs can cause or contribute to environmental and human health impacts (e.g., water quality standards violations, contamination of drinking water supplies, beach closures, etc.) which, in addition to flooded basements and overloaded wastewater treatment plants, are some symptoms of collection systems with inadequate capacity and improper management, operation, and maintenance. These problems create the need for both the owner or operator and the regulatory authority to conduct more thorough evaluations of sanitary sewer collection systems.

1.5 Purpose of CMOM Programs

CMOM programs incorporate many of the standard operation and maintenance activities that are routinely implemented by the owner or operator with a new set of information management requirements in order to:

- Better manage, operate, and maintain collection systems
- Investigate capacity constrained areas of the collection system
- Proactively prevent SSOs
- Respond to SSO events

The CMOM approach helps the owner or operator provide a high level of service to customers and reduce regulatory noncompliance. CMOM can help utilities optimize use of human and material resources by shifting maintenance activities from “reactive” to “proactive”—often leading to savings through avoided costs due to overtime, reduced emergency construction costs, lower insurance premiums, changes in financial performance goals, and fewer lawsuits. CMOM programs can also help improve communication relations with the public, other municipal works and regional planning organizations, and regulators.

It is important to note that the collection system board members or equivalent entity should ensure that the CMOM program is established as a matter of policy. The program should not be micro-managed, but an understanding of the resources required of the operating staff to implement and maintain the program is necessary.

In CMOM planning, the owner or operator selects performance goal targets, and designs CMOM activities to meet the goals. The CMOM planning framework covers operation and maintenance (O&M) planning, capacity assessment and assurance, capital improvement planning, and financial management planning. Information collection and management practices are used to track how the elements of the CMOM program are meeting performance goals, and whether overall system efficiency is improving.

On an periodic basis, utility activities should be reviewed and adjusted to better meet the performance goals. Once the long-term goal of the CMOM program is established, interim goals may be set. For instance, an initial goal may be to develop a geographic information system (GIS) of the system. Once the GIS is complete, a new goal might be to use the GIS to track emergency calls and use the information to improve maintenance planning.

An important component of a successful CMOM program is periodically collecting information on current systems and activities to develop a “snapshot-in-time” analysis. From this analysis, the owner or operator evaluates its performance and plans its CMOM program activities.

Maintaining the value of the investment is also important. Collection systems represent major capital investments for communities and are one of the communities’ major capital assets. Equipment and facilities will deteriorate through normal use and age. Maintaining value of the capital asset is a major goal of the CMOM program. The infrastructure is what produces sales and service. Proper reinvestment in capital facilities maintains the ability to provide service and generate sales at the least cost possible and helps ensure compliance with environmental requirements. As a capital asset, this will result in the

need for ongoing investment in the collection system and treatment plant to ensure design capacity while maintaining existing facilities and equipment as well as extending the life of the system.

The performance of wastewater collection systems is directly linked to the effectiveness of its CMOM program. Performance characteristics of a system with an inadequate CMOM program include frequent blockages resulting in overflows and backups. Other major performance indicators include pump station reliability, equipment availability, and avoidance of catastrophic system failures such as a collapsed pipe.

A CMOM program is what an owner or operator should use to manage its assets; in this case, the collection system itself. The CMOM program consists of a set of best management practices that have been developed by the industry and are applied over the entire life cycle of the collection system and treatment plant. These practices include:

- Designing and constructing for O&M
- Knowing what comprises the system (inventory and physical attributes)
- Knowing where the system is (maps and location)
- Knowing the condition of the system (assessment)
- Planning and scheduling work based on condition and performance
- Repairing, replacing, and rehabilitating system components based on condition and performance
- Managing timely, relevant information to establish and prioritize appropriate CMOM activities
- Training of personnel

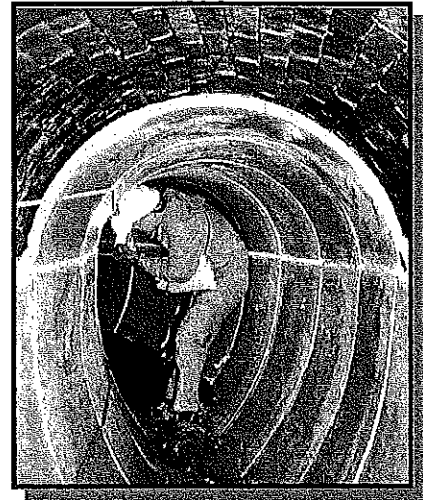

Sewer rehabilitation can include lining aging sewers (photo: NJ Department of Environmental Protection).

1.6 National Pollutant Discharge Elimination System Regulatory Requirement

The National Pollutant Discharge Elimination System (NPDES) program prohibits discharges of pollutants from any point source into the nation's waters except as authorized under an NPDES permit.

EPA and state NPDES inspectors evaluate collection systems and treatment plants to determine compliance with permit conditions including proper O&M. Among others, these permit conditions are based on regulation in 40 CFR 122.41(e): "The permittee shall at all times properly operate and maintain all facilities and systems of treatment and control (and related appurtenances) which are installed or used by the permittee to achieve compliance with the conditions of this permit."

When violations occur, the collection system or wastewater treatment plant owner or operator can face fines and requirements to implement programs to compensate residents and restore the environment. For example, in June 2004, the U.S. District Court for the Southern District of Ohio entered a consent decree resolving CSO, SSO, and wastewater treatment plant violations at the Hamilton County sewer system in Cincinnati, Ohio. In addition to a \$1.2 million civil penalty, the settlement included programs to clean up residents' basements, compensate residents, and implement measures to prevent further basement backups. The settlement also includes over \$5.3 million in supplemental environmental projects.

1.7 EPA Region 4 MOM Programs Project

EPA Region 4 created the "Publicly Owned Treatment Works MOM Programs Project" under which the Region invites permitted owners or operators, and contributing satellite systems, in watersheds it selects to perform a detailed self-assessment of the management, operation, and maintenance (MOM) programs associated with their collection system. Participants provide a report which includes the results of the review, any improvements that should be made, and schedules to make those improvements. Participants that identify and report a history of unpermitted discharges from their collection system, and a schedule for the necessary improvements, can be eligible for smaller civil penalties while under a remediation schedule.

EPA's Office of Compliance coordinated with EPA Region 4 on the development of this CMOM Guide. This guide is based in part on material obtained from the Region 4 MOM Programs Project. Some of the more specific items of the Region 4 program have been omitted in order to provide a more streamlined review framework. The fundamental concepts behind CMOM have been maintained in this guide. By combining elements of the Region's program with existing NPDES inspection guidance, this CMOM Guide provides a comprehensive framework for reviewers and regulated communities to evaluate the effectiveness of O&M throughout the collection system.

CHAPTER 2. COLLECTION SYSTEM CAPACITY, MANAGEMENT, OPERATION, AND MAINTENANCE PROGRAMS

This chapter provides an overview of the CMOM program elements. The information will help evaluate wastewater collection system operation and maintenance (O&M) practices. The key elements of the CMOM program, which are presented in detail in the following sections, include:

- Collection System Management
- Collection System Operation
- Collection System Maintenance
- Collection System Capacity Evaluation

In addition to this overview, there are several areas (e.g., 2.1.3 Internal Communications, 2.1.4 Customer Service, etc.) in this guide that go into greater depth regarding the operation and maintenance of a collection system. The intent of this detail is not only to provide the owner or operator with suggestions as to what to look for in their own program, but to provide the reviewer a complete overview of good operations, in general, regardless of a particular item resulting in poor performance or a violation.

For EPA and state inspectors or other reviewers, conducting an evaluation of collection system CMOM programs shares many similarities with other types of compliance reviews. Overall, the reviewer would examine records, interview staff and conduct field investigations, generally in that order although tailored, if necessary, to meet site-specific needs. Prior to performing the on-site interviews and evaluations, preliminary information may be requested that will provide an overall understanding of the organization to allow for a more focused approach for the review. This information also provides a basis for more detailed data gathering during on site activities. The information typically requested prior to the review should include a schematic map of the collection system (could be as-built drawings) and any written operations or maintenance procedures. Depending on the volume of information, the collection system owner or operator may need ample lead time to gather and copy these documents. Alternatively, the reviewer may offer to examine the documents and bring them back when doing the on-site review so that extra copies are not necessary. No matter which method is used, the importance of up-front preparation cannot be overemphasized. With the exception of pump stations and manholes, much of the collection system is not visible. Therefore, the more complete the reviewer's understanding of the system is prior to the review, the more successful the assessment will be.

The reviewer would then proceed with the on-site activities. Guidance for conducting compliance reviews is provided in the *NPDES Compliance Inspection Manual* (EPA 2004). The manual provides the general procedures for performing compliance reviews and is a valuable source of information on such topics as entry, legal authority, and responsibilities of the reviewer. Although CMOM evaluations are not specifically addressed in the manual, the general

review procedures can be applied to CMOM reviews. Another good reference for general review information is the *Multi-Media Investigations Manual, NEIC* (EPA 1992). Some issues with entry are specific to CMOM reviews. Some facilities may be on private property and the reviewer may need property owner consent for entry.

Documents to Review On-site Include:

- Organization chart(s)
- Staffing plans
- Job descriptions
- Sewer use ordinance
- Overall map of system showing facilities such as pump stations, treatment plants, major gravity sewers, and force mains
- O&M budget with cost centers¹ for wastewater collection
- Performance measures for inspections, cleaning, repair, and rehabilitation
- Recent annual report, if available
- Routine reports regarding system O&M activities
- Collection system master plan
- Capital improvement projects (CIP) plan
- Flow records or monitoring
- Safety manual
- Emergency response plan
- Management policies and procedures
- Detailed maps/schematics of the collection system and pump stations
- Work order management system
- O&M manuals
- Materials management program
- Vehicle management and maintenance records
- Procurement process
- Training plan for employees
- Employee work schedules
- Public complaint log
- Rate ordinance or resolution
- Financial report ("notes" section)
- As built plans
- Discharge monitoring reports (DMRs)

The above list is not all inclusive nor will all utilities necessarily have formal, written documentation for each of the items listed. The *Collection System Performance Indicator Data Collection Form*, included as Appendix A, provides examples of the types of information a reviewer should attempt to obtain while on-site.

Interviews are generally conducted with line managers and supervisors who are responsible for the various O&M activities

Reviewer - Point to Note

A schedule should be established by the reviewer for the staff interviews and field assessments.

¹ A cost center is any unit of activity, group of employees, line of products, etc., isolated or arranged in order to allocate and assign costs more easily.

and support services staff from engineering, construction, human resources, and purchasing, where appropriate. Appendix B presents an example agenda and schedule that would be used for a large collection system owner or operator. The collection system's size and physical characteristics will determine the length of time needed for the review. A guideline for the time required, given a two person review team, would be two days for a small system, and a week or more for large systems.

Field reviews are typically conducted after interviews. The following is a list of typical field sites the team should visit:

- Mechanical and electrical maintenance shop(s)
- Fleet maintenance facilities (vehicles and other rolling stock)
- Materials management facilities (warehouse, outside storage yards)
- Field maintenance equipment storage locations (i.e., crew trucks, mechanical and hydraulic cleaning equipment, construction and repair equipment, and television inspection equipment)
- Safety equipment storage locations
- Pump stations
- Dispatch and supervisory control and data acquisition (SCADA) systems
- Crew and training facilities
- Chemical application equipment and chemical storage areas (use of chemicals for root and grease control, hydrogen sulfide control [odors, corrosion])
- Site of SSOs, if applicable
- A small, but representative, selection of manholes

Collection system operators typically assist with manhole cover removal and other physical activities. The inspector should refrain from entering confined spaces. A confined space is defined by the Occupational Safety and Health Administration (OSHA) as a space that: (1) is large enough and so configured that an employee can bodily enter and perform assigned work; and (2) has limited or restricted means for entry or exit; and (3) is not designed for continuous employee occupancy [29 CFR 1910.146(b)]. A "permit-required confined space (permit space)" is a confined space that has one or more of the following characteristics: (1) contains or has a potential to contain a hazardous atmosphere; (2) contains a material that has the potential for engulfing an entrant; (3) has an internal configuration such that an entrant could be trapped or asphyxiated by inwardly converging walls or by a floor which slopes downward and tapers to a smaller cross-section; or (4) contains any other recognized serious safety or health hazard [29 CFR 1910.146(b)].

Though OSHA has promulgated standards for confined spaces, those standards do not apply directly to municipalities, except in those states that have approved plans and have asserted jurisdiction under Section 18 of the OSHA Act. Contract operators and private facilities do have to comply with the OSHA requirements and the inspector may find that some municipalities elect to do so voluntarily. In sewer collection systems, the two most common confined spaces are the underground pumping station and manholes. The underground pumping station is typically entered through a relatively narrow metal or concrete shaft via a fixed ladder. Inspectors conducting the field evaluation component of the CMOM audit should be able to identify and

avoid permit-required confined spaces. Although most confined spaces are unmarked, confined spaces that may have signage posted near their entry containing the following language:

**DANGER–PERMIT REQUIRED–CONFINED SPACE
AUTHORIZED PERSONNEL ONLY**

If confined space entry is absolutely necessary, inspectors should consult with the collection system owner or operator first, have appropriate training on confined space entry, and use the proper hazard detection and personal safety equipment. More information on confined space entry can be found in *Operation and Maintenance of Wastewater Collection Systems Volumes I and II* (California State University (CSU) Sacramento 1996; CSU Sacramento 1998).

2.1 Collection System Management

Collection system management activities form the backbone for operation and effective maintenance activities. The goals of a management program should include:

- Protection of public health and prevention of unnecessary property damage
- Minimization of infiltration, inflow and exfiltration, and maximum conveyance of wastewater to the wastewater treatment plant
- Provision of prompt response to service interruptions
- Efficient use of allocated funds
- Identification of and remedy solutions to design, construction, and operational deficiencies
- Performance of all activities in a safe manner to avoid injuries

Management Documents to Review

- Organization chart(s)
- Staffing plans—Number of people and classifications
- Job descriptions for each classification
- Sewer use ordinance
- Safety manual
- Training program documentation
- Notes to financial reports

Without the proper procedures, management and training systems, O&M activities may lack organization and precision, resulting in a potential risk to human health and environmental contamination of surrounding water bodies, lands, dwellings, or groundwater. The following sections discuss the common elements of a robust collection system management program.

2.1.1 Organizational Structure

Well-established organizational structure, which delineates responsibilities and authority for each position, is an important component of a CMOM program for a collection system. This information may take the form of an organizational chart or narrative description of roles and

responsibilities, or both. The organizational chart should show the overall personnel structure, including operation and maintenance staff. Additionally, up-to-date job descriptions should be available. Job descriptions should include the nature of the work performed, the minimum requirements for the position, the necessary special qualifications or certifications, examples of the types work, lists of licences required for the position, performance measures or promotion potential. Other items to note in regard to the organizational structure are the percent of staff positions currently vacant, on average, the length of time positions remain vacant, and the percent of collection system work that is contracted out.

Reviewer - Point to Note

The reviewer may want to note the turnover rate and current levels of staffing (i.e., how many vacant positions exist and for how long they have been vacant). This may provide some indication of potential understaffing, which can create response problems.

Reviewers should evaluate specific qualifications of personnel and determine if the tasks designated to individuals, crews, or teams match the job descriptions and training requirements spelled out in the organizational structure. From an evaluation standpoint, the reviewer might try to determine what type of work is performed by outside contractors and what specific work is reserved for collection system personnel. If much of the work is contracted, it is appropriate to review the contract and to look at the contractor's capabilities. If the contractor handles emergency response, the reviewer should examine the contract with the owner or operator to determine if the emergency response procedures and requirements are outlined.

The inclusion of job descriptions in the organizational structure ensures that all employees know

Reviewer - Point to Note

A reviewer should look for indications that responsibilities are understood by employees. Such indications may include training programs, meetings between management and staff, or policies and procedures.

their specific job responsibilities and have the proper credentials. Additionally, it is useful in the course of interviews to discuss staff management. The reviewer should note whether staff receive a satisfactory explanation of their job descriptions and responsibilities. In addition, when evaluating the CMOM program, job descriptions will help a reviewer determine who should be interviewed.

When evaluating the organizational structure, the reviewer should look for the following:

- Except in very small systems, operation and maintenance personnel ideally should report to the same supervisor or director. The supervisor or director should have overall responsibility for the collection system.
- In some systems, maintenance may be carried out by a city-wide maintenance

organization, which may also be responsible for such diverse activities as road repair and maintenance of the water distribution system. This can be an effective approach, but only if adequate lines of responsibility and communication are established.

- In general, one supervisor should manage a team of individuals small enough that is safe and effective. However, the individuals on the team may have additional employees reporting to them. This prevents the top supervisors from having to track too many individuals. The employee-supervisor ratio at individual collection systems will vary depending on their need for supervisors.

In a utility with well-established organizational structure, staff and management should be able to articulate their job and position responsibilities. Personnel should be trained to deal with constantly changing situations and requirements, both regulatory and operational.

The system's personnel requirements vary in relation to the overall size and complexity of the collection system. In very small systems, these responsibilities may include operation of the treatment plant as well as the collection system. In many systems, collection system personnel are responsible for the stormwater as well as wastewater collection system. References providing staff guidelines or recommendations are available to help the reviewer determine if staffing is adequate for the collection system being reviewed. Following is a list of available references:

- *Manpower Requirements for Wastewater Collection Systems in Cities of 150,000 to 500,000 Population* (EPA 1974)
- *Manpower Requirements for Wastewater Collection Systems in Cities and Towns of up to 150,000 Population* (EPA 1973)
- *Operation and Maintenance of Wastewater Collection Systems, Volume II* (California State University (CSU) Sacramento 1998)

Volumes I and II of *Operations and Maintenance of Wastewater Collection Systems* can be obtained through:

Office of Water Programs
California State University Sacramento
6000 J Street
Sacramento, CA 95819-6025
phone: 916/278-6142
www.owp.csus.edu

The following tables have been taken from the two EPA documents listed above to provide the reviewer with guidance. However, these documents may not take into account technological advances that have occurred since their publication date that might reduce staffing requirements. For instance, advances in remote data acquisition and telemetry have likely reduced the number

of field inspection staff needed for systems with several pump stations. Other system-specific characteristics should also be accounted for when using these tables. An example of this might be collection systems that are not primarily constructed of brick will not require the masons the tables specify.

**STAFF COMPLEMENTS FOR WASTEWATER COLLECTION SYSTEM MAINTENANCE
POPULATION SIZE
(Estimated Number of Personnel)**

Occupational Title	5,000		10,000		25,000		50,000		100,000	
	(a)	(b)	(a)	(b)	(a)	(b)	(a)	(b)	(a)	(b)
Superintendent	1	5	1	10	1	20	1	40	1	40
Assistant Superintendent										
Maintenance Supervisor							1	40	2	80
Foreman	1	15	1	20	1	20	1	40	1	40
Maintenance Man II	1	15	1	20	1	20	1	40	1	40
Maintenance Man I	1	15	1	20	2	60	3	120	5	200
Mason II							1	40	1	40
Mason I									1	40
Maint. Equipment Personnel					1	40	2	80	3	120
Construction Equipment Personnel	1	15	1	20	1	20	1	40	1	40
Auto. Equipment Personnel									1	40
Photo. Inspection Technician									1	40
Laborer	1	15	1	20	2	40	2	80	5	200
Dispatcher							1	40	2	80
Clerk Typist							1	20	1	20
Stock Clerk							1	40	1	40
Sewer Maint. Staff	6	80	6	110	9	220	16	620	27	1,060
Maintenance Mechanic II	see comment (c) below									
Maintenance Mechanic I	see comment (d) below									
Maintenance Mechanic Helper	see comment (d) below									
Construction Inspection Supervisor	see comments (e) and (f) below									
Total Staff										

(a) Estimated number of personnel.

(b) Estimated total man-hours per week.

(c) Multiply number of lift stations maintained by 8/3.

(d) Multiply number of lift station visits per week by 1.

(e) Multiply estimated construction site visits per week by 8/3.

(f) Determined by the number of Construction Inspectors employed and developed on a judgmental basis.

Unit processes included in this staffing table are:

1. Maintenance of sanitary sewer main lines & appurtenances (laterals not included).
2. Maintenance of storm sewer main lines.
3. Maintenance of lift stations.
4. Inspection of newly constructed sewer main lines and appurtenances.

(U.S. EPA 1973)

**STAFF COMPLEMENTS FOR WASTEWATER COLLECTION SYSTEM MAINTENANCE
POPULATION SIZE
(Estimated Number of Personnel)**

Occupational Title	150,000	200,000	300,000	400,000	500,000
Superintendent	1	1	1	1	1
Assistant Superintendent	1	1	1	1	1
Maintenance Supervisor II	1	1	1	1	1
Maintenance Supervisor I	1	2	2	3	3
Equipment Supervisor	1	1	1	1	1
TV Technician II	1	2	2	3	3
TV Technician I	1	2	2	3	3
Foreman	2	3	4	5	6
Maintenance Man II	3	5	6	8	9
Maintenance Man I	11	17	22	29	33
Mason II	1	2	2	3	3
Mason I	1	2	2	3	3
Maintenance Equipment Personnel	6	8	12	15	18
Construction Equipment Personnel	3	4	6	8	9
Auto. Equipment Personnel	2	3	4	5	6
Laborer	7	10	14	18	22
Dispatcher	2	2	2	3	3
Stock Clerk	1	2	2	3	3
Clerk Typist	2	2	2	3	3
Sewer Maintenance Staff	48	70	88	116	131
Maintenance Mechanic II				see comment (a) below	
Maintenance Mechanic I				see comment (b) below	
Maintenance Mechanic Helper				see comment (b) below	
Electrician				see comment (c) below	
Construction Inspector Supervisor				see comment (d) below	
Construction Inspector				see comment (e) below	
Total Staff					

(a) Divide number of lift stations maintained by 15.

(b) Divide number of lift station visits per week by 40

(c) Divide number of lift stations maintained by 15.

(d) Determined by the number of Construction Inspectors employed and developed on a judgmental basis.

(e) Divide estimated daily construction site visits by 2.

Unit processes included in this staffing table are:

1. Maintenance of sanitary sewer main lines & appurtenances (laterals not included).
2. Maintenance of storm sewer main lines.
3. Maintenance of lift stations.
4. Inspection of newly constructed main lines and appurtenances.

(U.S. EPA 1974)

2.1.2 Training

The commitment of management to training is key to a successful program. It is important to recognize training as a budget expense item. A guideline for the typical amount of funding for training is three to five percent of the gross budget for the collection system. However, in large collection systems or those undergoing extensive construction this percentage may be considerably lower, and, in systems with a high turnover, training costs may be higher due to orienting new employees. Other changes, such as incorporation of new technology, will have a short-term impact on training costs. Although training is not explicitly required under current regulations, a collection system with untrained or poorly trained collection system personnel runs a greater risk of experiencing noncompliance.

The following elements are essential for an effective training program:

- Fundamental mission, goals, and policies of the collection system are addressed
- Mandatory training requirements are identified for key employees
- On-the-job training progress and performance are measured
- Effectiveness of the training is assessed including periodic testing, drills, or demonstrations
- New employees receive training

The owner or operator should generally provide training in the following areas:

- Routine line maintenance (may be on-the-job training only)
- Safety during confined space entry (every system should also have a strict policy and permit program)
- Traffic control (where applicable)
- Record keeping
- Pump station O&M
- Electrical and instrumentation (may be a combination of formal and on-the-job training)
- Public relations and customer service
- SSO/Emergency response
- Pump station operations and maintenance
- Pipe repair; bursting or cured in place pipe (CIPP); or closed circuit TV and trench/shoring (where these activities are not outsourced)

Sources of Training

Training is required to safely perform inspections, follow replacement procedures, and lubricate and clean parts and equipment. Following are the many sources of maintenance training:

- Manufacturer
- In-house
- On-the-job (OJT)
- Industry-wide (e.g., consultants, regulatory authorities, professional associations, or educational institutions)

The training program should identify the types of training required and offered. Types of training vary, but may include general environmental awareness, specific equipment, policies and

procedures, and conducting maintenance activities. If the owner or operator is carrying out its own training, the reviewer should evaluate one or more examples of training materials to answer the following questions: are the materials appropriate to the training topic and the level of those being trained; and are they likely to accomplish the intended goal?

Owner or Operator - Point to Note

The owner or operator should routinely assess the effectiveness of training through periodic testing, drills, demonstrations, or informal reviews, and improve training based on this assessment.

2.1.3 Internal Communication

Communication is essential to ensuring that collection systems run efficiently and effectively. It is especially important that an effective communication link exists between wastewater treatment plant operators and collection system crews as well as with other municipal departments.

Effective communication requires the top-down, bottom-up, and lateral exchange of information amongst staff. Examples of top-down communication are bulletin board posters, paycheck inserts, regular staff meetings, e-mail or informal brown-bag lunch discussions. Examples of bottom-up communication may include the establishing environmental committees, confidential hotlines, e-mail, or direct open discussions. Collection system owners or operators may also offer incentives to employees for performance, and encourage them to submit suggestions for ways to improve the performance of the collection system. "Front line" employees are often an excellent source of ideas, issues, and information about how to improve performance at the work site. In this context, the reviewer can check for morale-boosting activities or reward programs, such as "Employee of the Month" and "Employee of the Year."

The reviewer should attempt to determine lines of internal communication to ensure all employees receive information and have an appropriate forum to provide feedback. The reviewer should assess the level of communication by interviewing several levels of staff or by simply observing collection system teams on work assignments. The owner or operator should have procedures and be able to demonstrate internal communication between the various levels and functions of the collection system regarding its management, operation, and maintenance programs.

2.1.4 Customer Service

The community often knows very little about the wastewater treatment and collection services performed for them. The community may only be aware of the collection system and its owner or operator through articles in local newspapers, public radio and television announcements, or only when there is an SSO. Collection system representatives should talk to schools and universities, make presentations to local officials and businesses about the wastewater field. Formal presentations can also be given to citizens, building inspectors, public utility officials,

and members of the media.

An effective customer service and public relations program ensures that the owner or operator addresses all incoming inquiries, requests, and complaints in a timely fashion. From this information, owners or operators may further develop or revise programs to better address areas of concern. The reviewer should examine customer service records for the following:

- Personnel who received the complaint or request
- Date and nature of the complaint or request
- Location of the problem
- Name, address, and telephone number of the customer
- Cause of the problem
- To whom the follow-up action was assigned
- The initial date of the follow-up action
- Date the complaint or request was resolved
- Total days to end the problem
- Feedback to the customer

Awareness of past issues, population served, compliance history, and other elements help a reviewer determine whether the amount and types of inquiries, requests, or complaints are increasing or decreasing. For example, there may have been many complaints during only a certain week. The reviewer can examine those records to determine if there were specific circumstances (e.g., a large precipitation event) that caused the increase in inquiries or complaints.

Reviewer - Point to Note

To fully understand the context of customer inquiries, requests, or complaints, a reviewer should understand the history, topography, boundaries, and demographics of the collection system's jurisdiction before site evaluations are conducted.

Employees who handle customer service should be specifically trained to handle complaints, requests, or inquiries. These employees should be provided with sample correspondence, Q/A's, or "scripts" to help guide them through written or oral responses to customers. The reviewer should look for procedures on how to answer the telephone, e-mail, and other communication used by personnel. A reviewer may evaluate staff telephone responses by evaluating:

- The number of persons available to answer calls
- The number of repeat callers
- The average length of calls
- The volume of calls per day

Collection system field crews and their activities are the most visible segment of any wastewater treatment organization. Workers project a public image for their system on city and town streets. For this reason, personnel need to be trained in what to expect in public situations. For example,

collection system supervisory staff should be familiar with the areas around public rights-of-way and easements to which their field crews must gain access to service facilities. Additionally, crew leaders should know how to deal with the public when approached.

Collection systems field crews influence the public's confidence in the collection system owner or operator. Reviewers should observe whether personnel wear uniforms or not, and if vehicles and equipment are identifiable as utility property and kept in good working order. Vehicles should be equipped with adequate emergency lighting and flashers, traffic control signs and barriers, etc. Before major construction or maintenance work begins, owners or operators should notify homeowners where properties may be affected. Methods of notification may include door hangers, newspaper notices, fliers, signs, or public radio or television announcements. Information should also be provided to residents on cleanup and safety procedures following basement backups and other overflows.

2.1.5 Management Information Systems

The ability of the owner or operator to effectively manage its collection system is directly related to its ability to maintain access to the most current information concerning the facilities. Maintenance of this current information is an effort involving all members of the collection system from the staff answering the telephone to the worker in the street. Operational information informs and clarifies financial information. This will make the financial information more useful for the policy makers, leading to better decisions. A satisfactory management information system should provide the owner or operator with the following advantages:

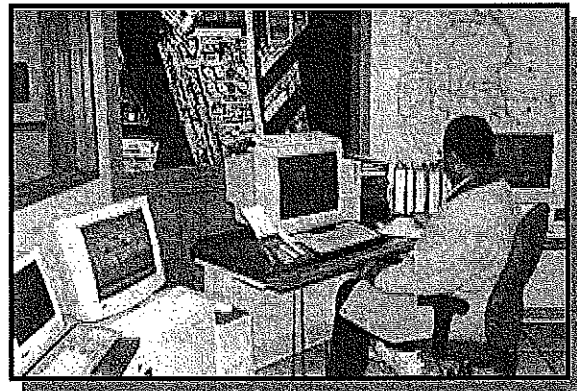

A growing number of sewer systems have shifted to computer-based collection system management [photo: Milwaukee Metropolitan Sewerage District (MMSD)].

- Maintain preventive maintenance and inspection schedules
- Offer budgetary justification
- Track repairs and work orders
- Organize capital replacement plans
- Manage tools and equipment inventories
- Create purchase orders
- Record customer service inquiries, complaints, or requests
- Provide measurement of effectiveness of program and O&M activities

Owners and operators have been shifting to computer-based systems to manage data. Only the smaller collection system owners or operators may still rely on paper management systems.

Computer-based Maintenance Management Systems (CMMSs) are designed to manage the data needed to track the collection system's O&M performance. Geographic Information Systems (GIS) are used to map and locate facilities and because of computer-based compatibility, can often easily be integrated with a CMMS. The computer-based system however, can only be as accurate as the data used to develop it, which was most likely paper files.

Types of Management Information Tracking

- Customer service
- Safety incident
- Emergency response
- Process change
- Inspection scheduling and tracking
- Monitoring and/or sampling schedules
- Compliance
- Planned maintenance (schedules and work orders)
- Parts inventory

Regardless of the information management style chosen, the collection system should have written instructions regarding the use of the management information systems. These procedures may include operating the system, upgrading the system, accessing data and information, and generating and printing reports. The system should be kept current with accurate information. Work reports from the field crews should be complete, accurate, and legible.

The reviewer may select some number of complaints and see how well they can be tracked through the system to an ultimate conclusion. Work reports generated by the field crew should be randomly chosen and scanned for legibility and completeness. The reviewer should do a random check of the timeliness and accuracy of data entry. Additionally, the reviewer should obtain selected original data sources (such as field reports) and compare them to the appropriate database output to determine how long entry takes. This will provide a check on how current the database is and what data entry backlog exists.

2.1.6 SSO Notification Program

The owner or operator should maintain a written procedure indicating the entities, (e.g., drinking water purveyors, the public, public health officials, and the regulatory authority) that should be notified in the event of an SSO. The procedure should clearly indicate the chain of communication used to notify the proper personnel of an SSO event for reporting and remediation. The procedure should include the names, titles, phone numbers, and responsibility of all personnel involved. The reviewer should verify that the personnel listed in the procedure are still in the position listed and are aware of their responsibilities.

Reviewer - Point to Note

To verify the effectiveness of the notification program, the reviewer should walk an overflow occurrence report through the chain of events that would occur from the time of initial notification.

The procedure may allow for different levels of response for different types of SSOs. For example, the regulatory authority may request that SSOs due to sewer line obstructions be

reported on a monthly basis. Therefore, the procedure may simply be to gather this information from the maintenance information system and have the appropriate personnel put together a reporting form. A chronic SSO at a pump station that discharges when overloaded during wet weather may require a more complex notification procedure, including immediate telephone notification to specified authorities.

To verify the effectiveness of the notification program, the reviewer should walk an overflow occurrence report through the chain of events that would occur from the time of initial notification. This can be done by choosing several random overflow events from the complaint records and observing whether they are handled as procedures dictate. The minimum information that should be reported for an SSO includes the date, time, location, cause, volume of the overflow (which may be estimated), how it was stopped, and any remediation methods taken. The reviewer should not only verify that the SSO notification procedures are appropriate, but also verify that the owner or operator has reliable methods for the detection of overflows and a phone number or hotline for the public to report observed overflow events.

2.1.7 Legal Authority

The collection system owner or operator should select and enforce the legal authority necessary to regulate the volume of flow entering the collection system, including residential and commercial customers, satellite communities and industrial users. The legal authority may take the form of sewer use ordinances, contracts, service agreements, and other legally binding documents.

A **satellite community** is a collection systems which does not own the treatment facility to which it discharges.

The pretreatment program seeks to prevent the discharge of materials into the sewer system (by non-domestic users) that interfere with proper operation of the wastewater treatment plant or may pass through the plant untreated. At the time the operator of a wastewater treatment plant submits its pretreatment program to the regulatory authority for approval, the plant operator must include a statement from the city solicitor or other legal authority that the plant has the authority to carry out the program [40 CFR 403.9(a)(1)]. The reviewer should verify the existence of this statement and inquire as to whether any significant changes have occurred in the program such that the legal authority may need further review. Additionally, some owners or operators may have a pretreatment program approved by the state, through which discharge permits are issued to industrial users and enforcement is conducted. Further information on legal authority under the pretreatment program may be found in *Procedures Manual for Reviewing a POTW Pretreatment Program Submission* (EPA 1983).

The owner or operator should have the authority to ensure that new and rehabilitated sewers and connections have been properly designed, constructed, and tested before being put into service. This authority could take the form of design and performance specifications in a sewer use ordinance or other legal document such as a statute or series of contracts or joint powers agreements. The ordinance or legal document should contain, at a minimum, general prohibitions, adequate grease control requirements and measures, prohibitions on stormwater inflow, infiltration from laterals, and new construction standards.

The grease control section of the document should contain the requirement to install grease traps at appropriate facilities (e.g., restaurants). Additionally, these facilities should be required to properly maintain the grease traps and pump them out on a regular basis. The document should also address periodic inspections of grease traps by collection system personnel and the ability to enforce (i.e., levy fines on persistent offenders).

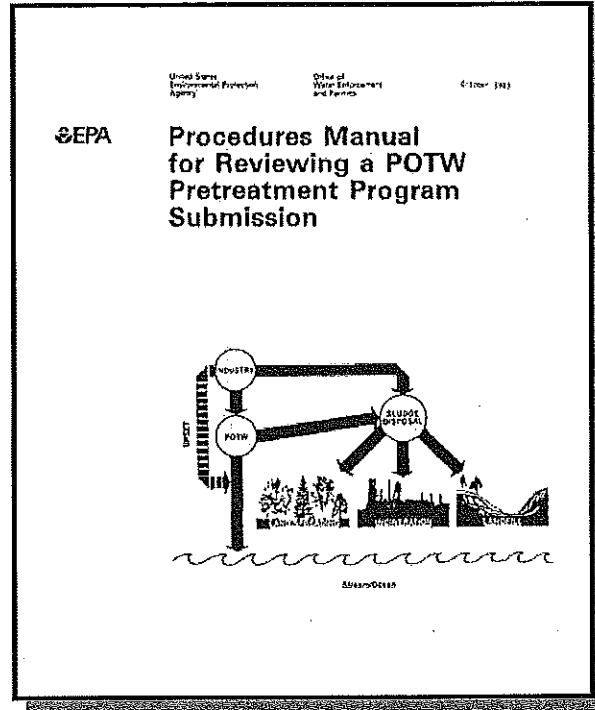

General Prohibitions

- Fire and explosion hazards
- Corrosive and obstructive materials
- Material which may cause interference at the wastewater treatment plant
- Heat which may inhibit biological activity at the wastewater treatment plant
- Oils or petroleum products which may cause interference or pass through the wastewater treatment plant

The owner or operator should maintain strict control over the connection of private sewer laterals to sewer mains. These connections have significant potential as sources of infiltration. Standards for new connections should be clearly specified. The sewer use ordinance should contain provisions for inspection, approval of new connections, and a program to implement the requirements. A method to maintain control over existing connections is to

require an inspection of the lateral prior to sale of a property. It is important to note that implementing this type of program may require a change to the local ordinance or code.

The owner or operator should also have the legal authority to prohibit stormwater connections to the sanitary sewer. Stormwater connections may include catch basins; roof, cellar and yard drains; sump pumps; direct connections between the storm and sanitary sewers; leaking manhole covers; uncapped cleanouts; and the direct entrance of streams into the collection system. This practice is now discouraged. Direct stormwater connections to a separate sanitary sewer system are known as inflow. Inflow can severely impact the ability of the collection system to transport flows to the treatment plant during wet weather, leading to overflows and noncompliance with the wastewater treatment plant's NPDES permit.

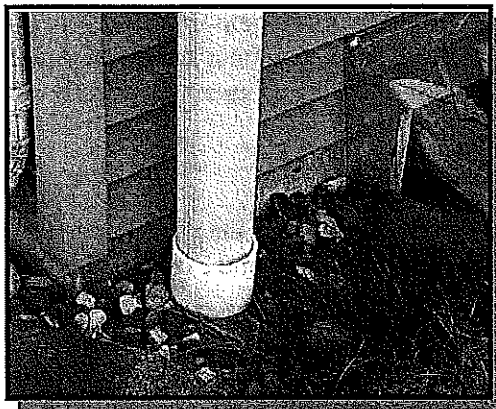

Sources of stormwater in the collection system may include building downspouts connected directly to the system (photo: MMSD).

Satellite communities should not be allowed to contribute excessive flows that cause or contribute to overflows, flooding, or noncompliance at the wastewater treatment plant. Should

Owner or Operator - Point to Note

The owner or operator should have a comprehensive program which addresses flows from satellite communities.

any of these situations exist, it is not sufficient for the owner or operator to charge the satellite community for the excess flow. The owner or operator must be able to prohibit the contribution of the excess flow. This may be done through a legal inter-jurisdictional agreement between the wastewater treatment plant owner or operator and the satellite community that addresses allowable flows and sets requirements. The reviewer should examine all contracts between systems and their

satellites (unless too numerous, then select representative contracts). Contracts should have a date of termination and allow for renewal under renegotiated terms. Contracts should limit flow from satellite communities and limit peak wet weather flow rates.

2.2 Collection System Operation

Collection systems have little of what is traditionally referred to as "operability" as compared to a wastewater treatment plant (i.e., the number of ways to route the wastewater is typically limited). However, the design of some collection systems does allow flow to be diverted or routed from one pipe to another or even to different treatment plants. This can be accomplished by redirecting flow at a pump station from one discharge point to another or opening and closing valves on gravity sewers and force mains.

Owner or Operator - Point to Note

There should be detailed, written procedures available to guide owners or operators through flow routing activities. Also, there should be operating procedures for mechanical equipment such as pump station pump on/off and service rotation settings or in-line grit removal (grit trap) operations.

There are many reasons why the owner or operator may want to divert flows; among them, to relieve overloading on a system of piping or the wastewater treatment plant or to add more flow to piping serving an area not yet fully developed to maintain a cleansing velocity.

2.2.1 Budgeting

The budget is one of the most important variables in the CMOM program. Although an adequate budget is not a guarantee of a well operated collection system, an inadequate budget will make attaining this goal difficult. Funding can come from a variety of sources, including user fees or appropriations from the state or local government.

Reviewer - Point to Note

Reviewers need to determine the source of the funding for the collection system and who controls it. Reviewers should also request budget documents, summaries, or pie charts to learn more about the systems' budget.

A key element of the operation budget program is the tracking of costs in order to have accurate records each time the annual operating budget is developed. Having an annual baseline provides documentation for future budget considerations and provides justification for future rate increases. Collection system management

should be aware of the procedures for calculating user rates and for recommending and making user rate changes.

Collection system and wastewater treatment plant costs may be combined into one budget, or budget line items may be divided into each of two individual budgets. For example, electrical and mechanical maintenance work performed by plant staff on a pump station may be carried as an O&M cost in the treatment plant budget, although pumping stations are generally considered to be a collection system component.

The cost of preventive and corrective maintenance and major collection system repairs and alterations are key items in the annual operating budget. The collection system owner or operator should keep adequate records of all maintenance costs, both in-house and contracted, plus the costs for spare parts. This will assist in the preparation of the following year's budget. In general, there should be an annual (12-month cycle) budget of discretionary and non-discretionary items. There may also be a Capital Improvement Plan (CIP) which may encompass small projects (one to two year cycles) or larger projects (three to five year cycles). Larger projects may include items such as equipment, labor, training, or root cause failure analysis.

Examples of O&M Budget Items

- Labor (usually at least 50% of total budget)
- Utilities
- Capital
- Maintenance materials and supplies
- Chemicals
- Motor vehicles
- Contracted services

The major categories of operating costs are labor, utilities, and supplies. Cost accounting for

these categories should include information on unit costs, total costs, and the amount and/or quantities used. The reviewer should evaluate the current and proposed budget, and current year balance sheets. In examining current and proposed expenditure levels, the reviewer should consider:

- Whether the budgets include contributions to capital reserve (sinking) funds. These funds are savings for replacement of system components once they reach their service life.
- Whether all income from water and sewer billings supports those functions, or if it goes into the general fund.
- Whether raising user fees is a feasible option to meet budget needs based on recent expenditure history.

2.2.2 Monitoring

The collection system owner or operator may be responsible for fulfilling some water quality or other monitoring requirements. Responsibilities may include:

- Monitoring discharges into the collection system from industrial users
- Monitoring to determine the effects of SSOs on receiving waters
- Monitoring required as part of an NPDES permit, a 308 letter, administrative order, or consent decree

The owner or operator should maintain written procedures to ensure that sampling is carried out in a safe, effective, and consistent manner. The procedures should specify, at a minimum the following:

- Sampling location(s)
- Sample volumes, preservatives, and holding times
- Instructions for the operation of any automatic sampling and/or field monitoring (e.g., pH or dissolved oxygen) equipment
- Sampling frequency
- Sampling and analytical methodologies
- Laboratory QA/QC

Records should be maintained of sampling events. These records should at a minimum include the following:

- Date, time, and location of sampling
- Sample parameters
- Date shipped or delivered to the laboratory

2.2.3 Hydrogen Sulfide Monitoring and Control

The collection system owner or operator should have a program under which they monitor areas of the collection system which may be vulnerable to the adverse effects of hydrogen sulfide. It may be possible to perform visual inspections of these areas. The records should note such items as the condition of metal components, the presence of exposed rebar (metal reinforcement in concrete), copper sulfate coating on copper pipes and electrical components, and loss of concrete from the pipe crown or walls.

Areas Subject to Generation of Hydrogen Sulfide:

- Sewers with low velocity conditions and/or long detention times
- Sewers subject to solids deposition
- Pump stations
- Turbulent areas, such as drop manholes or force main discharge points
- Inverted siphon discharges

As mentioned in Section 2.4.2, the collection system owner or operator should be carrying out routine manhole inspections. The hydrogen sulfide readings generated as a result of these inspections should be added to the records of potential areas of corrosion. A quick check of the pH of the pipe crown or structure enables early indication of potential hydrogen sulfide corrosion. A pH of less than four indicates further investigation is warranted. "Coupons" may be installed in structures or pipelines believed to be potentially subject to corrosion. Coupons are small pieces of steel inserted into the area and measured periodically to determine whether corrosion is occurring.

Reviewer - Point to Note

The reviewer should be aware that a system in which infiltration and inflow (I/I) has successfully been reduced may actually face an increased risk of corrosion. The reviewer should pay particular attention to the hydrogen sulfide monitoring program in these systems.

The reduction of flow through the pipes allows room for hydrogen sulfide gases to rise into the airway portion of the sewer pipe and react with the bacteria and moisture on the pipe walls to form sulfuric acid. Sulfuric acid corrodes ferrous metals and concrete.

There are several methods to prevent or control hydrogen sulfide corrosion. The first is proper design. Design considerations are beyond the scope of this manual but may be found in the *Design Manual: Odor and Corrosion Control in Sanitary Sewerage Systems and Treatment Plants* (EPA 1985). The level of dissolved sulfide in the wastewater may also be reduced by chemical or physical means such as aeration, or the addition of chlorine, hydrogen peroxide, potassium permanganate, iron salts, or sodium hydroxide. Whenever chemical control agents are used, the owner or operator should have procedures for their application and maintain records of the dosages of the various chemicals. Alternatively, sewer cleaning to remove deposited solids reduces hydrogen sulfide generation. Also, air relief valves may be installed at the high points of the force main system. The valve allows air to exit thus avoiding air space at the crown of the pipe where acid can form. The reviewer should examine the records to see that these valves are

receiving periodic maintenance.

Collection systems vary widely in their vulnerability to hydrogen sulfide corrosion. Vitrified clay and plastic pipes are very resistant to hydrogen sulfide corrosion while concrete, steel, and iron pipes are more susceptible. The physical aspects of the collection system are also important. Sewage in pipes on a decline that moves the wastewater at a higher velocity will have less hydrogen sulfide than sewage in pipes where the wastewater may experience longer detention times. Therefore, some systems may need a more comprehensive corrosion control program while some might limit observations to vulnerable points.

2.2.4 Safety

The reasons for development of a safety program should be obvious for any collection system owner or operator. The purpose of the program is to define the principles under which the work is to be accomplished, to make the employees aware of safe working procedures, and to establish and enforce specific regulations and procedures. The program should be in writing (e.g., procedures, policies, and training courses) and training should be well documented.

The purpose of safety training is to stress the importance of safety to employees. Safety training can be accomplished through the use of manuals, meetings, posters, and a safety suggestion program. One of the most common reasons for injury and fatalities in wastewater collection systems is the failure of victims to recognize hazards. Safety training cuts across all job descriptions and should emphasize the need to recognize and address hazardous situations. Safety programs should be in place for the following areas:

Point to Note

Although a safety program may not be explicitly required under current NPDES regulations, an excessive injury rate among personnel increases the likelihood of collection system noncompliance with other requirements. Furthermore, when good safety practices are not followed, there may be a risk to the public or to collection system workers.

- Confined spaces
- Chemical handling
- Trenching and excavations
- Material Safety Data Sheets (MSDS)
- Biological hazards in wastewater
- Traffic control and work site safety
- Lockout/Tagout
- Electrical and mechanical safety
- Pneumatic or hydraulic systems safety

The collection system owner or operator should have written procedures which address all of the

above issues and are made available to employees. In addition to training, safety programs should incorporate procedures to enforce the program. For example, this could include periodic tests or “pop” quizzes to monitor performance and/or compliance and follow-up on safety related incidents.

Reviewer - Point to Note

The reviewer should, in the course of interviewing personnel, determine their familiarity with health and safety procedures according to their job description.

The owner or operator should maintain all of the safety equipment necessary for system staff to perform their daily activities and also undertake any emergency repairs. This equipment should include, at minimum:

- Atmospheric gas testing equipment
- Respirators and/or self-contained breathing apparatus
- Full body harness
- Tripods or non-entry rescue equipment
- Hard hats
- Safety glasses
- Rubber boots
- Rubber and/or disposable gloves
- Antibacterial soap
- First aid kit
- Protective clothing
- Confined space ventilation equipment
- Traffic and/or public access control equipment
- Hazardous gas meter

Each field crew vehicle should have adequate health and safety supplies. If the reviewer has access to the municipal vehicle storage area, he or she might choose to check actual vehicle stocks, not just supplies in storage.

2.2.5 Emergency Preparedness and Response

The collection system owner or operator should have a comprehensive plan in place for dealing with both routine and catastrophic emergencies. Routine emergencies include situations such as overflowing manholes, line breaks, localized electrical failure, and power outages at pump stations. Catastrophic emergencies include floods, tornados, earthquakes, other natural events, serious chemical spills, or widespread electrical

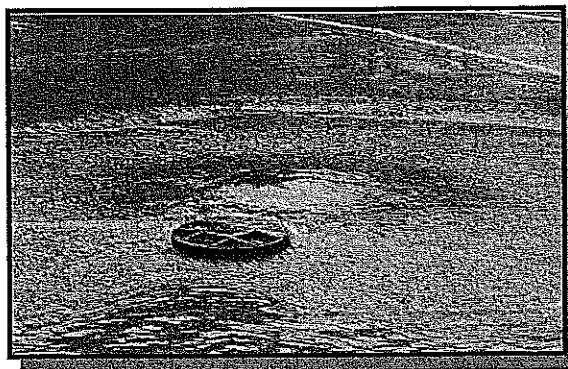

SSOs can include overflows out of manholes onto city streets, sidewalks, and surrounding areas (photo: U.S. EPA).

failure. Ideally, this plan is written, reviewed, and adjusted as needed at periodic intervals.

The reviewer should determine if the emergency response plan generally follows the guidelines described below. The location where the plan is housed may vary but, in general, such a document should be available in the yard office or other building commonly accessible to and frequented by collection system personnel. The emergency preparedness and response procedures may be contained in the collection system's O&M manual, or may be reflected in the descriptions of equipment and unit operations. Putting emergency procedures in a stand-alone document, rather than combining it with other information in the O&M manual, makes it easier for collection system personnel to find information.

The plan should utilize the most current information on the collection system. For larger systems, a structured analysis, or *risk assessment*, should be made of the collection system, treatment plant, and the community. The risk assessment should identify areas where the collection system is vulnerable to failure and determine the effect and relative severity to collection systems operations, equipment and public safety, and health of such a failure. The risk assessment should concentrate on such factors as topography, weather, sewer system size, and other site-specific factors which reflect the unique characteristics of the system. Once the areas of vulnerability are known, the collection system owner or operator should have appropriate plans in place to ensure collection system operations continue for the duration of the emergency.

The plans must clearly identify the steps staff should take in the event of emergency situations. Plans should include information on when it is appropriate to initiate and cease emergency operations. The plans should be very specific as to the collection system or repair equipment involved. Instructions should be available which explain how to operate equipment or systems during an emergency event when they are not functioning as intended but are not fully inoperable. The plan should also include specific procedures for reporting events that result in an overflow or other noncompliance event to the appropriate authorities.

The owner or operator should track emergency situations to become better prepared for future emergencies and to assist with reporting and maintaining compliance with emergency-related requirements. Typical components of an emergency program may include:

- General information regarding emergencies, such as telephone numbers of collection system personnel, fire department, and ambulance.
- Identification of hazards (e.g., chlorine storage areas) and use of universal classification system for hazards: combustible material, flammable liquids, energized electrical circuits, and hazardous materials.
- Vulnerability analysis that identifies the various types of emergencies that could occur, such as natural disasters, power outages, or equipment failures.
- Emergency response procedures.
- Methods to reduce risk of emergencies.
- Responsibilities of staff and management.

- Continuous training.

Procedures for emergency response plans should be understood and practiced by all personnel in order to ensure safety of the public and the collection system personnel responding. Procedures should be specific to the type of emergency that could occur. It is important to keep detailed records of all past emergencies in order to constantly improve response training, as well as the method and timing of future responses. The ability to deal with emergencies depends on the knowledge and skill of the responding crews, in addition to availability of equipment. The crew should be able to rapidly diagnose problems in the field under stress and select the right equipment needed to correct the problem. If resources are limited, consideration should be given to contracting other departments or private industries to respond to some emergency situations, for example, those rare emergencies that would exceed the capacity of staff.

2.2.6 Modeling

Computer programs (modeling programs) are available that are capable of simulating the different flows within the collection system. The purpose of modeling is to determine system capacity requirements with respect to sewer design and structural conditions. Therefore the input of accurate data on sizes, location, elevation, and condition of sewer system components such as pipes, manholes, and pump stations is necessary. When possible, flow monitoring data should be used to calibrate the model.

Modeling is also useful in examining effects before and after rehabilitation. For example, models can be applied to “before” and “after” scenarios to estimate the effects of repairs. If a collection system is not experiencing any capacity related issues (i.e., overflows, bypasses, basement backups, street flooding, hydraulic overload at the treatment plant, etc.) then maintenance of a model may be optional for that system, although most medium and large systems should maintain a model of the larger diameter portion of their system. If any of the mentioned conditions are occurring then development and maintenance of a model is essential to performing a capacity assessment in the problem areas.

Reviewer - Point to Note

The reviewer should determine whether a model used by the owner or operator:

- Has user support
- Has adequate documentation such as a user’s manual that describes data input requirements, output to be expected, model capabilities and limitations, and hardware

Computer modeling is a specialized and complex subject. The reviewer may not have a comprehensive knowledge of modeling. If this is the case the he or she should obtain the following basic information:

- Is the owner or operator using a model?
- What areas of the collection system are being modeled and why?
- What model (including the version) is being used? Who developed the model and when?

- How are the modeling results being used?

2.2.7 Mapping

The importance of maintaining accurate, current maps of the collection system cannot be overstated. Efficient collection system maintenance and repairs are unlikely if mapping is not adequate. Collection system maps should clearly indicate the information that personnel need to carry out their assignments. The collection system maps should contain information on the following:

- Main, trunk and interceptor sewers
- Building/house laterals
- Manholes
- Cleanouts
- Force mains
- Pump stations
- Service area boundaries
- Other landmarks (roads, water bodies, etc.)

Collection system maps should have a numbering system which uniquely identifies all manholes and sewer cleanouts. The system should be simple and easy to understand. Manholes and sewer cleanouts should have permanently assigned numbers and never be renumbered. Maps should also indicate the property served and reference its cleanout.

Sewer line maps should indicate the diameter, the length between the centers of manholes, and the slope or direction of flow. The dimensions of easements and property lines should be included on the maps. Other information that should be included on maps are access and overflow points, a scale, and a north arrow. All maps should have the date the map was drafted and the date of the last revision. Although optional, maps often include materials of pipe construction. Maps may come in different sizes and scales to be used for different purposes. Detailed local maps may be used by maintenance or repair crews to perform the duties. However, these detailed local maps should be keyed to one overall map that shows the entire system.

Geographic Information System (GIS) technology have made the mapping and map updating process considerably more efficient. GIS is a computerized mapping program capable of combining mapping with detailed information about the physical

Key Design Characteristics

- Line locations, grades, depths, and capacities
- Maximum manhole spacing and size
- Minimum pipe size
- Pumping Station dimensions and capacities
- Drop manholes
- Flow velocities and calculations (peak flow and low-flow)
- Accessibility features
- Other technical specifications (e.g., materials, equipment)

structures within the collection system. If a GIS program is being used by the owner or operator, the reviewer should ask if the program is capable of accepting information from the owner or operator's management program.

Specific procedures should be established for correction of errors and updating maps and drawings. Field personnel should be properly trained to recognize discrepancies between field conditions and map data and record changes necessary to correct the existing mapping system. Reviewers should check to see that maps and plans are available to the personnel in the office and to field personnel or contractors involved in all engineering endeavors.

2.2.8 New Construction

The owner or operator should maintain strict control over the introduction of flows into the system from new construction. New construction may be public (i.e., an expansion of the collection system) or private (i.e., a developer constructing sewers for a new development). Quality sanitary sewer designs keep costs and problems associated with operations, maintenance, and construction to a minimum. Design flaws are difficult to correct once construction is complete. The reviewer should be aware that this has historically not been adequately addressed in some collection systems. The owner or operator should have standards for new construction, procedures for reviewing designs and protocols for inspection, start-up, testing, and approval of new construction. The procedures should provide documentation of all activities, especially inspection. Reviewers should examine construction inspection records and be able to answer the following:

- Does the volume of records seem reasonable given system size?
- Do records reflect that the public works inspectors are complying with procedures?

The state or other regulatory authority may also maintain standards for new construction. The standards held by the owner or operator should be at least as stringent. Start-up and testing should be in accordance with the manufacturers' recommendation where applicable and with recognized industry practices. Each step of the review, start-up, testing, and approval procedures should be documented.

The owner or operator approval procedure should reflect future ease of maintenance concerns. After construction is complete, a procedure for construction testing and inspection should be used. Construction supervision should be provided by qualified personnel such as a registered professional engineer.

2.2.9 Pump Stations

Proper operation, maintenance, and repair of pump stations typically requires special electrical, hydraulic, and mechanical knowledge. Pump station failure may damage equipment, the environment, or endanger public health. Variation in equipment types, pump station

configuration, and geographical factors determine pump station design and O&M requirements.

The reviewer should verify that the O&M manual contains procedures in writing for the following:

- Are pumps rotated manually or automatically? If manually, how frequently?
- Are wet well operating levels set to limit pump starts and stops?
- Is there a procedure for manipulating pump operations (manually or automatically) during wet weather to increase in-line storage of wet weather flows?
- Is flow monitoring provided? How is the data collected used?
- Does the pump station have capacity-related overflows? Maintenance related overflows? Is overflow monitoring provided?
- Is there a history of power outages? Is there a source of emergency power? If the emergency power source is a generator, is it regularly exercised under load?

2.3 Equipment and Collection System Maintenance

Every collection system owner or operator should have a well-planned, systematic, and comprehensive maintenance program. The goals of a maintenance program should include:

- Prevention of overflows
- Maximization of service and system reliability at minimum cost
- Assurance of infrastructure sustainability (i.e., ensure all components reach their service life)

There should then be procedures which describe the maintenance approach for various systems. In addition, there should be detailed instructions for the maintenance and repair of individual facilities. These instructions should provide a level of detail such that any qualified collection system personnel or repair technician could perform the repair or maintenance activity.

Maintenance may be planned or unplanned. There are essentially two types of planned maintenance; predictive and preventive. Predictive maintenance is a method that tries to look for early warning signs of equipment failure such that emergency maintenance is avoided. Preventive maintenance consists of scheduled maintenance activities performed on a regular basis. There are two types of unplanned maintenance, corrective and emergency. Corrective maintenance consists of scheduled repairs to problems identified under planned or predictive maintenance. Emergency maintenance are activities (typically repairs) performed in response to a serious equipment or line failure where action must be taken immediately. The goal of every owner or operator should be to reduce corrective and emergency maintenance through the use of planned and predictive maintenance. The reviewer should evaluate the progress of the owner or operator in achieving that goal. The goals of the reviewer in assessment of the maintenance program are:

- Identify SSOs caused by inadequate maintenance
- Determine maintenance trends (i.e., frequent emergency maintenance performed as opposed to predictive maintenance)
- Identify sustainability issues (i.e., inadequate maintenance to allow system components to reach service life and/or many components nearing or at service life)

2.3.1 Maintenance Budgeting

The cost of a maintenance program is a significant part of the annual operating budget. The collection system owner or operator should track all maintenance costs incurred throughout the year, both by internal staff and contractors, to ensure that the budget is based on representative costs from past years. Budgets should be developed from past cost records which usually are categorized according to preventive maintenance, corrective maintenance, and projected and actual major repair requirements. Annual costs should be compared to the budget periodically to control maintenance expenditures.

The reviewer should evaluate the maintenance budget keeping in mind the system's characteristics, such as age. Costs for emergency repairs should be a relatively small percentage of the budget; five to ten percent would not be considered excessive. The establishment of an "emergency reserve" may also be included as part of the maintenance budget. This is especially useful where full replacement is not funded. The budget should also be considered in light of maintenance work order backlog. The labor budget should be evaluated for consistency with local pay rates and staffing needs and the reviewer should compare local pay rates and staffing needs according to the tables in Section 2.1.1.

2.3.2 Planned and Unplanned Maintenance

A planned maintenance program is a systematic approach to performing maintenance activities so that equipment failure is avoided. Planned maintenance is composed of predictive and preventive maintenance. In the end, a good planned maintenance program should reduce material and capital repair and replacement costs, improve personnel utilization and morale, reduce SSOs, and sustain public confidence.

Examples of predictive maintenance includes monitoring equipment for early warning signs of impending failure, such as excess vibration, heat, dirty oil, and leakage. Assessment and inspection activities can be classified as predictive maintenance. Vibration and lubrication analyses, thermography, and ultrasonics are among the more common predictive maintenance tools. Predictive maintenance also takes into account historical information about the system as all systems will deteriorate over time. A predictive maintenance program strives to identify potential problem areas and

Reviewer - Point to Note

The reviewer should inquire as to whether tools such as vibration and lubrication analysis, thermography, or ultrasonics are used, and obtain information on the extent of the programs.

uncover trends that could affect equipment performance. Predictive maintenance offers an early warning. It allows collection system personnel to detect early signs of increasing rates of wear and therefore failure, and thus shift a “corrective” task into a “planned” task. To be truly effective predictive, however, maintenance should not spur personnel into doing the work too soon and wasting useful life and value of the equipment in question.

The basis of a good predictive maintenance program is recordkeeping. Only with accurate recordkeeping can baseline conditions be established, problem areas identified, and a proactive approach taken to repairs and replacement.

Effective preventive maintenance minimizes system costs and environmental impacts by reducing breakdowns and thus the need for corrective or emergency maintenance, improves reliability by minimizing the time equipment is out of service, increases the useful life of equipment thus avoiding costly premature replacement, and avoids potential noncompliance situations. An effective preventive maintenance program includes:

- Trained personnel
- Scheduling based on system specific knowledge
- Detailed instructions related to the maintenance of various pieces of equipment
- A system for recordkeeping
- System knowledge in the form of maps, historical knowledge and records

An effective preventive maintenance program builds on the inspection activities and predictive maintenance described in Sections 2.4.1 to 2.4.4, and includes a well thought-out schedule for these activities.

The basis of the schedule for mechanical equipment maintenance (i.e., pump station components) should be the manufacturers’ recommended activities and frequencies. This schedule may then be augmented by the knowledge and experience of collection system personnel to reflect the site-specific requirements. The schedule for sewer line cleaning, inspection, root removal, and repair activities should be based on periodic inspection data. In most systems, uniform frequencies for sewer line cleaning, inspection, and root removal are not necessary and inefficient. In many systems, a relatively small percentage of the pipe generates most of the problems. Efficient use of inspection data allows the owner or operator to implement a schedule in the most constructive manner. In rare cases it may be appropriate to reduce maintenance frequency for a particular piece of equipment. An example of a scheduling code and maintenance schedule for a pump is shown below:

Lubrication

Lubrication is probably one of the most important maintenance activities for mechanical systems, such as pumps and motors. Frequency of lubrication, choice of lubricant and lubrication procedure are all important factors in this activity. These items should closely follow manufacturer instructions, but may be modified to fit site-specific conditions and particular equipment applications.

Rotary Pump Maintenance Schedule	
Frequency	Maintenance Required
D	Check packing gland assembly
D	Check discharge pressure
S	Inspect and lubricate bearings
A	Flush bearings and replace lubricant

D = Daily

A = Annually

S = Semiannually

Typically, there is a maintenance card or record for each piece of equipment within the collection system. These records should contain maintenance recommendations, schedule, and instructions on conducting the specific maintenance activity. The records should include documentation regarding any maintenance activities conducted to date and other observations related to that piece of equipment or system. Maintenance records are generally kept where maintenance personnel have easy access to them. The reviewer should examine the full series of periodic work orders (i.e. weekly, monthly, semiannually, and annually) for a selection of system components (e.g., a few pump stations, several line segments). The reviewer should then compare the recommended maintenance frequency to that which is actually performed. He or she should also look at the backlog of work; not focusing solely on the number of backlogged work orders, but on what that number represents in time. A very large system can have a hundred orders backlogged and only be one week behind. In a computerized system, a listing of all open work orders is usually very simple for collection system personnel to generate. The owner or operator should be able to explain their system for prioritizing work orders.

The reviewer needs to clearly understand the following:

- How the maintenance data management system works
- How work orders are generated and distributed
- How field crews use the work orders
- How data from the field is collected and returned
- How and on whose authority work orders are closed out

The reviewer should check to see if data entry is timely and up to date.

Unplanned maintenance is that which takes place in response to equipment breakdowns or emergencies. Unplanned maintenance may be corrective or emergency maintenance. Corrective maintenance could occur as a result of preventive or predictive maintenance activities which identified a problem situation. A work order should be issued so that the request for corrective maintenance is directed to the proper personnel. An example of non-emergency corrective maintenance could be a broken belt on a belt driven pump. The worn belt was not detected and

replaced through preventive maintenance and therefore the pump is out of service until corrective maintenance can be performed. Although the pump station may function with one pump out of service, should another pump fail, the situation may become critical during peak flow periods.

If the information can be easily generated the reviewer should select a sampling of work orders and compare them to the corrective maintenance database to determine if repairs are being made in a timely manner. Reviewers should note the current backlog of corrective maintenance work orders. A corrective maintenance backlog of two weeks or less would indicate an owner or operator in control of corrective maintenance. The owner or operator should be able to explain corrective maintenance work orders that have not been completed within six months.

Corrective maintenance takes resources away from predictive and preventive maintenance. When corrective maintenance becomes a predominant activity, personnel may not be able to perform planned maintenance, thus leading to more corrective maintenance and emergency situations. Emergency maintenance occurs when a piece of equipment or system fails, creating a threat to public health, the environment, or associated equipment. This type of maintenance involves repairs, on short notice, of malfunctioning equipment or sewers. A broken force main, totally non-functional pump station, and street cave-ins are all examples of emergency situations.

Types of Portable Emergency Equipment

- Bypass pumps
- Portable generator
- Air compressor, trailer-mounted
- Manhole lifters and gas testing equipment
- Sewer rodder and/or flushing machine
- Portable lights and hand tools
- Chemical spray units (for insects and rodent control)
- Truck (1-ton) and trailers
- Vacuum truck
- Repair equipment for excavation (backhoe, shoring equipment, concrete mixers, gasoline operated saws, traffic control equipment, etc.)
- Confined space entry gear

Emergency crews should be geared to a 24-hour-a-day, year-round operation. Most large systems have staffed 24-hour crews; many small systems have an "on-call" system. The owner or operator should be able to produce written procedures which spell out the type of action to take in a particular type of emergency and the equipment and personnel requirements necessary to carry out the action. The crews should have copies of these procedures and be familiar with them. Equipment must be located in an easily accessible area and be ready to move in a short period of time. Vehicles and equipment must be ready to perform, under extreme climatic conditions if necessary. The emergency crew

Reviewer - Point to Note

The reviewer should note the presence of supplies during the review of the yard where equipment and spare parts are maintained and personnel are dispatched.

may need materials such as piping, pipe fittings, bedding materials and concrete. The owner or operator should have supplies on hand to allow for two point (i.e. segment, fitting, or appurtenance) repairs of any part of its system.

Pump stations should be subject to inspection and preventive maintenance on a regular schedule. The frequency of inspection may vary from once a week, for a reliable pump station equipped with a telemetry system, to continuous staffing at a large pump station. The basic inspection should include verification that alarm systems are operating properly, wet well levels are properly set, all indicator lights and voltage readings are within acceptable limits, suction and discharge pressures are within normal limits, that the pumps are running without excessive heat or vibration and have the required amount of lubrication, and that the emergency generator is ready if needed. Less frequent inspections may include such items as vibration analysis and internal inspection of pump components.

Owner or Operator - Point to Note
Occasionally a supervisor should perform an unscheduled inspection to confirm that tasks have been performed as expected.

Observations and tasks performed should be recorded in a log book or on a checklist at the pump station. It is important to note how this data returns to the central maintenance data management system. At the time of the inspection, collection system personnel may perform minor repairs if necessary. If non-emergency repairs are required that are beyond the staff's training, it will probably be necessary to prepare a work order which routes a request through the proper channels to initiate the repair action. During the review the reviewer should check a random number of work orders to see how they move through the system. The reviewer should note whether repairs are being carried out promptly. In pump stations, for critical equipment (pumps, drives, power equipment, and control equipment), there should not be much backlog, unless the staff is waiting for parts.

During the review, the reviewer should also make on-site observations of a representative pump stations. The reviewer should plan at least half an hour to look at the simplest two-pump prefabricated station, and one to two hours to look at a larger station. In large systems, drive time between stations may be significant. The reviewer should strive to see a range of pump station sizes and types (i.e., the largest, smallest, most remote and any that review of work orders has indicated might be problematic).

Overall, the pump station should be clean, in good structural condition and exhibit minimal odor. The reviewer should note the settings of the pumps (i.e., which are operating, which are on stand-by, and which are not operating and why). The operating pumps should be observed for noise, heat, and excessive vibration. The settings in the wet well should be noted (as indicated on the controls, as direct observation of the reviewer in the wet well is not recommended) and the presence of any flashing alarm lights. The reviewer is reminded of the atmospheric hazards in a pump station (make sure ventilation has been running prior to arrival) and to avoid confined

space entry. If the pump station has an overflow its outlet should be observed, if possible, for signs of any recent overflows such as floatable materials or toilet paper. The reviewer should check the log book and/or checklist kept at the pump station to ensure that records are current and all maintenance activities have been performed. Below is a listing of items that indicate inadequate maintenance:

- Overall poor housekeeping and cleanliness
- Excessive grease accumulation in wet well
- Excessive corrosion on railings, ladders, and other metal components
- Sagging, worn, improperly sized, or inadequate belts
- Excessive equipment out of service for repair or any equipment for which repair has not been ordered (i.e., a work order issued)
- Pumps running with excessive heat, vibration, or noise
- Peeling paint and/or dirty equipment (the care given to equipment's outer surfaces often, but not always, mirrors internal condition)
- Check valves not closing when pumps shut off
- Inoperative instrumentation, alarms, and recording equipment
- "Jury-rigged" repairs (i.e., "temporary" repairs using inappropriate materials)
- Leakage from pumps, piping, or valves (some types of pump seals are designed to "leak" seal water)
- Inadequate lighting or ineffective/inoperative ventilation equipment

2.3.3 Sewer Cleaning

The purpose of sewer cleaning is to remove accumulated material from the sewer. Cleaning helps to prevent blockages and is also used to prepare the sewer for inspections. Stoppages in gravity sewers are usually caused by a structural defect, poor design, poor construction, an accumulation of material in the pipe (especially grease), or root intrusion. Protruding traps (lateral sewer connections incorrectly installed so that they protrude into the main sewer) may catch debris which then causes a further buildup of solids that eventually block the sewer. If the flow is less than approximately 1.0 to 1.4 feet per second, grit and solids can accumulate leading to a potential blockage.

<u>Results of Various Flow Velocities</u>	
<u>Velocity</u>	<u>Result</u>
2.0 ft/sec.....	Very little material buildup in pipe
1.4-2.0 ft/sec.....	Heavier grit (sand and gravel) begin to accumulate
1.0-1.4 ft/sec.....	Inorganic grit and solids accumulate
Below 1.0 ft/sec.....	Significant amounts of organic and inorganic solids accumulate
(EPA 1974)	

There are three major methods of sewer cleaning: hydraulic, mechanical, and chemical.

Hydraulic cleaning (also referred to as flushing) refers to any application of water to clean the pipe. Mechanical cleaning uses physical devices to scrape, cut, or pull material from the sewer. Chemical cleaning can facilitate the control of odors, grease buildup, root growth, corrosion, and insect and rodent infestation. For additional information on sewer cleaning methods refer to Volumes I and II of *Operation and Maintenance of Wastewater Collection Systems* (CSU Sacramento 1996 and 1998).

The backbone of an effective sewer cleaning program is accurate recordkeeping. Accurate recordkeeping provides the collection system owner or operator with information on the areas

Sewer Cleaning Records

- Date, time, and location of stoppage or routine cleaning activity
- Method of cleaning used
- Cause of stoppage
- Identity of cleaning crew
- Further actions necessary and/or initiated
- Weather conditions

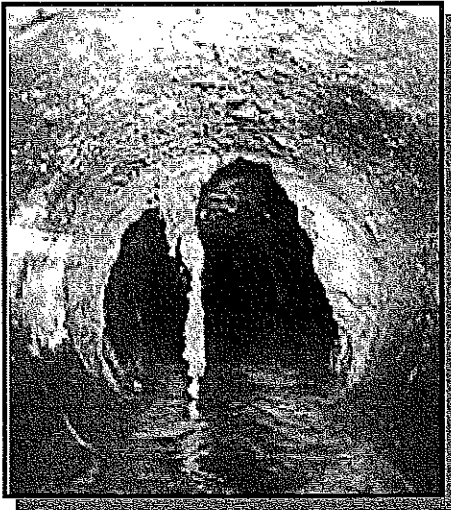

Root and grease buildup can cause blockages in a sewer system [photo: North Carolina Department of Natural Research (NCDNR)].

of the collection system susceptible to stoppages such that all portions of the system can be on an appropriate schedule. The reviewer should examine the records for legibility and completeness. He or she should then review the database to determine if entry of the field notes is current and accurate.

Sewers vary widely in their need for preventive cleaning. The collection system in a restaurant district may require cleaning every six months in order to prevent grease blockages. An area of the sewer system with new PVC piping and no significant grease contribution with reasonable and consistent slopes (i.e., no sags) may be able to go five years with no problems.

The owner or operator should be able to identify problem collection system areas, preferably on a map. Potential problem areas identified should include those due to grease or industrial discharges, hydraulic bottlenecks in the collection system, areas of poor design (e.g., insufficiently sloped sewers), areas prone to root intrusion, sags, and displacements. The connection between problem areas in the collection system and the preventive maintenance cleaning schedule should be clear. The owner or operator should also be able to identify the number of stoppages experienced per mile of sewer pipe. If the system is experiencing a steady increase in stoppages, the reviewer should try to determine the cause (i.e., lack of preventive maintenance funding, deterioration of the sewers due to age, an increase in grease producing activities, etc).

2.3.4 Parts and Equipment Inventory

An inventory of spare parts, equipment, and supplies should be maintained by the collection system owner or operator. The inventory should be based on equipment manufacturer's recommendations, supplemented by historical experience with maintenance and equipment problems. Without such an inventory, the collection system may experience long down times or periods of inefficient operation in the event of a breakdown or malfunction.

Files should be maintained on all pieces of equipment and major tools. The owner or operator should have a system to assure that each crew always has adequate tools. Tools should be subject to sign out procedures to provide accountability. Tools and equipment should be replaced at the end of their useful life. The reviewer should inquire as to how this is determined and how funds are made available to ensure this is the case. In addition, the reviewer should look at the tools and note their condition.

Basic Equipment Inventory

- Type, age, and description of the equipment
- Manufacturer
- Fuel type and other special requirements
- Operating costs and repair history

The owner or operator should maintain a yard where equipment, supplies, and spare parts are maintained and personnel are dispatched. Very large systems may maintain more than one yard. In this case, the reviewer should perform a visual survey at the main yard. In small to medium size systems, collection system operations may share the yard with the department of public works, water department, or other municipal agencies. In this case the reviewer should determine what percentage is being allotted for collection system items. The most important features of the yard are convenience and accessibility.

The reviewer should observe a random sampling of inspection and maintenance crew vehicles for equipment as described above. A review of the equipment and manufacturer's manuals aids in determining what spare parts should be maintained. The owner or operator should then consider the frequency of usage of the part, how critical the part is, and finally how difficult the part is to obtain when determining how many of the part to keep in stock. Spare parts should be kept in a clean, well-protected stock room. Critical parts are those which are essential to the operation of the collection system. Similar to equipment and tools management, a tracking system should be in place, including procedures on logging out materials, when maintenance personnel must use them. The owner or operator should be able to produce the spare parts inventory and clearly identify those parts deemed critical. The reviewer should evaluate the inventory and selected items in the stockroom to determine whether the specified number of these parts are being maintained.

Owner or Operator - Point to Note

The owner or operator should have a procedure for determining which spare parts are critical.

2.4 Sewer System Capacity Evaluation - Testing and Inspection

The collection system owner or operator should have a program in place to periodically evaluate the capacity of the sewer system in both wet and dry weather flows and ensure the capacity is maintained as it was designed. The capacity evaluation program builds upon ongoing activities and the everyday preventive maintenance that takes place in a system. The capacity evaluation begins with an inventory and characterization of the system components. The inventory should include the following basic information about the system:

- Population served
- Total system size (feet or miles)
- Inventory of pipe length, size, material and age, and interior and exterior condition as available
- Inventory of appurtenances such as bypasses, siphons, diversions, pump stations, tide or flood gates and manholes, etc., including size or capacity, material and age, and condition as available
- Force main locations, length, size and materials, and condition as available
- Pipe slopes and inverts
- Location of house laterals - both upper and lower

The system then undergoes general inspection (described below in Sections 2.4.1 to 2.4.4) which serves to continuously update and add to the inventory information.

The next step in the capacity evaluation is to identify the location of wet weather related SSOs, surcharged lines, basement backups, and any other areas of known capacity limitations. These areas warrant further investigation in the form of flow and rainfall monitoring and inspection procedures to identify and quantify the problem. The reviewer should determine that the capacity evaluation includes an estimate peak flows experienced in the system, an estimate of the capacity of key system components, and identifies the major sources of I/I that contribute to hydraulic overloading events. The capacity evaluation should also make use of a hydraulic model, if any, to identify areas with hydraulic limitations and evaluate alternatives to alleviate capacity limitations. Short and long term alternatives to address hydraulic deficiencies should be identified, prioritized, and scheduled for implementation.



A sewer inspection is an important part of a sewer system capacity evaluation (photo: N.J. Department of Environmental Protection).

2.4.1 Flow Monitoring

Fundamental information about the collection system is obtained by flow monitoring. Flow monitoring provides information on dry weather flows as well as areas of the collection system potentially affected by I/I. Flow measurement may also be performed for billing purposes, to assess the need for new sewers in a certain area, or to calibrate a model. There are three techniques commonly used for monitoring flow rates: (1) permanent and long-term, (2) temporary, and (3) instantaneous. Permanent installations are done at key points in the collection system such as the discharge point of a satellite collection system, pump stations, and key junctions. Temporary monitoring consists of flow meters typically installed for 30-90 days. Instantaneous flow metering is performed by collection system personnel, one reading is taken and then the measuring device is removed. The collection system owner or operator should have a flow monitoring plan that describes their flow monitoring strategy or should at least be able to provide the following information:

- Purpose of the flow monitoring
- Location of all flow meters
- Type of flow meters
- Flow meter inspection and calibration frequency

A flow monitoring plan should provide for routine inspection, service, and calibration checks (as opposed to actual calibration). In some cases, the data is calibrated rather than the flow meter. Checks should include taking independent water level (and ideally velocity readings), cleaning accumulated debris and silt from the flow meter area, downloading data (sometimes only once per month), and checking the desiccant and battery state. Records of each inspection should be maintained.

Flow measurements performed for the purpose of quantifying I/I are typically separated into three components: base flow, infiltration, and inflow. Base flow is generally taken to mean the wastewater generated without any I/I component. Infiltration is the seepage of groundwater into pipes or manholes through defects such as cracks, broken joints, etc. Inflow is the water which enters the sewer through direct connections such as roof leaders, direct connections from storm drains or yard, area, and foundation drains, the holes in and around the rim of manhole covers, etc. Many collection system owners or operators add a third classification: rainfall induced infiltration (RII). RII is stormwater that enters the collection system through defects that lie so close to the ground surface that they are easily reached. Although not from piped sources, RII tends to act more like inflow than infiltration.

In addition to the use of flow meters, which may be expensive for a small owner or operator, other methods of inspecting flows may be employed such as visually monitoring manholes during low-flow periods to determine areas with excessive I/I. For a very small system, this technique may be an effective and low-cost means of identifying problem areas in the system which require further investigation.

The owner or operator should have in place a program for the efficient identification of excessive I/I. The program should look at the wastewater treatment plant, pump stations, permanent meter flows, and rainfall data to characterize peaking factors for the whole system and major drainage basins. The reviewer should evaluate the program including procedures and records associated with the flow monitoring plan. Temporary meters should be used on a "roving" basis to identify areas with high wet weather flows. Areas with high wet weather flows should then be subject to inspection and rehabilitation activities.

2.4.2 Sewer System Testing

Sewer system testing techniques are often used to identify leaks which allow unwanted infiltration into the sewer system and determine the location of illicit connections and other sources of stormwater inflow. Two commonly implemented techniques include smoke testing and dyed water testing. Regardless of the program(s) implemented by the owner or operator, the reviewer should evaluate any procedures and records that have been established for these programs. The reviewer should also evaluate any public relations program and assess how the owner or operator communicates with the public during these tests (i.e., when there is a possibility of smoke entering a home or building).

Smoke testing is a relatively inexpensive and quick method of detecting sources of inflow in sewer systems, such as down spouts, or driveway and yard drains and works best suited for detecting cross connections and point source inflow leaks. Smoke testing is not typically used on a routine basis, but rather when evidence of excessive I/I already exists. With each end of the sewer of interest plugged, smoke is introduced into the test section, usually via a manhole. Sources of inflow can then be identified when smoke escapes through them.

Areas Usually Smoke Tested

- Drainage paths
- Ponding areas
- Roof leaders
- Cellars
- Yard and area drains
- Fountain drains
- Abandoned building sewers
- Faulty service connections

If the collection system owner or operator implements a regular program of smoke testing, the program should include a public notification procedure. The owner or operator should also have procedures to define:

- How line segments are isolated
- The maximum amount of line to be smoked at one time
- The weather conditions in which smoke testing is conducted (i.e., no rain or snow, little wind and daylight only)

The results of positive smoke tests should be documented with carefully labeled photographs. Building inspections are sometimes conducted as part of a smoke testing program and, in some cases, may be the only way to find illegal connections. If properly connected to the sanitary sewer system, smoke should exit the vent stacks of the surrounding properties. If traces of the

smoke or its odor enter the building, it is an indication that gases from the sewer system may also be entering. Building inspections can be labor intensive and require advanced preparation and communication with the public.

Dyed water testing may be used to establish the connection of a fixture or appurtenance to the sewer. It is often used to confirm smoke testing or to test fixtures that did not smoke. As is the case with smoke testing, it is not used on a routine basis but rather in areas that have displayed high wet weather flows. Dyed water testing can be used to identify structurally damaged manholes that might create potential I/I problems. This is accomplished by flooding the area close to the suspected manholes with dyed water and checking for entry of dyed water at the frame-chimney area, cone/corbel, and walls of the manhole.

2.4.3 Sewer System Inspection

Visual inspection of manholes and pipelines are the first line of defense in the identification of existing or potential problem areas. Visual inspections should take place on both a scheduled basis and as part of any preventive or corrective maintenance activity. Visual inspections provide additional information concerning the accuracy of system mapping, the presence and degree of I/I problems, and the physical state-of-repair of the system. By observing the manhole directly and the incoming and outgoing lines with a mirror, it is possible to determine structural condition, the presence of roots, condition of joints, depth of debris in the line, and depth of flow. The reviewer should examine the records of visual inspections to ensure that the following information is recorded:

- Manhole identification number and location
- Cracks or breaks in the manhole or pipe (inspection sheets and/or logs should record details on defects)
- Accumulations of grease, debris, or grit
- Wastewater flow characteristics (e.g., flowing freely or backed up)
- Inflow
- Infiltration (presence of clear water in or flowing through the manhole)
- Presence of corrosion
- Offsets or misalignments
- Condition of the frame
- Evidence of surcharge
- Atmospheric hazard measurements (especially hydrogen sulfide)
- If repair is necessary, a notation as to whether a work order has been issued

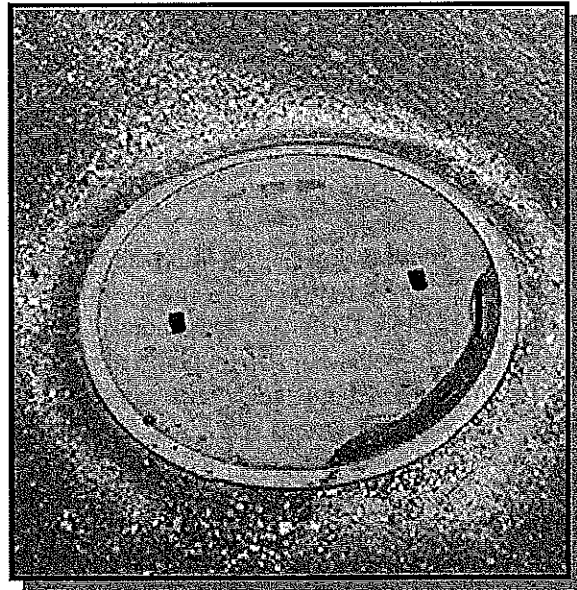

Damage to the sewer system infrastructure, such as this broken manhole cover allows stormwater into the sewer system (photo: Limno-Tech, Inc.)

Manholes should undergo routine inspection typically every one to five years. There should be a baseline for manhole inspections (e.g., once every two years) with problematic manholes being inspected more frequently. The reviewer should conduct visual observation at a small but representative number of manholes for the items listed above.

There are various pipeline inspection techniques, the most common include: lamping, camera inspection, sonar, and CCTV. These will be explained further in the following sections.

2.4.3.1 Sewer System Inspection Techniques

Sewer inspection is an important component of any maintenance program. There are a number of inspection techniques that may be employed to inspect a sewer system. The reviewer should determine if a inspection program includes frequency and schedule of inspections and procedures to record the results. Sewer system cleaning should always be considered before inspection is performed in order to provide adequate clearance and inspection results. Additionally, a reviewer should evaluate records maintained for inspection activities including if information is maintained on standardized logs and should include:

- Location and identification of line being inspected
- Pipe size and type
- Name of personnel performing inspection
- Distance inspected
- Cleanliness of the line
- Condition of the manhole with pipe defects identified by footage from the starting manhole
- Results of inspection, including estimates of I/I

Lamping involves lowering a still camera into a manhole. The camera is lined up with the centerline of the junction of the manhole frame and sewer. A picture is taken down the pipe with a strobe-like flash. A disadvantage of this technique is that only the first 10-12 feet of the pipe can be inspected upstream and downstream of the access point. Additionally, it has limited use in small diameter sewers. The benefits of this technique include not requiring confined space entry and little equipment and set-up time is required.

Camera inspection is more comprehensive than lamping in that more of the sewer can be viewed. A still camera is mounted on a floatable raft and released into a pipe. The camera takes pictures with a strobe-like flash as it floats through the sewer pipe. This technique is often employed in larger lines where access points are far apart. Similarly to lamping, portions of the pipe may still be missed using this technique. Obviously, there also must be flow in the pipe for the raft to float. This technique also does not fully capture the invert of the pipe and its condition.

Sonar is a newer technology deployed similarly to CCTV cameras, described in more detail below. The sonar emits a pulse which bounces off the walls of the sewer. The time it takes for

this pulse to bounce back provides data providing an image of the interior of the pipe including its structural condition. A benefit of this technique is that it can be used in flooded or inaccessible sections of the sewer. The drawback is that the technique requires heavy and expensive equipment.

Sewer scanner and evaluation is an experimental technology where a 360 degree scanner produces a full digital picture of the interior of the pipe. This technique is similar to sonar in that a more complete image of a pipe can be made than with CCTV, but not all types of sewer defects may be identified as readily (i.e., infiltration, corrosion).

Closed Circuit Television (CCTV) inspections are a helpful tool for early detection of potential problems. This technique involves a closed-circuit camera with a light which is self-propelled or pulled down the pipe. As it moves it records the interior of the pipe. CCTV inspections may be done on a routine basis as part of the preventive maintenance program as well as part of an investigation into the cause of I/I. CCTV, however, eliminates the hazards associated with confined space entry. The output is displayed on a monitor and videotaped. A benefit of CCTV inspection is that a permanent visual record is captured for subsequent reviews.

2.5 Sewer System Rehabilitation

The collection system owner or operator should have a sewer rehabilitation program. The objective of sewer rehabilitation is to maintain the overall viability of a collection system. This is done in three ways: (1) ensuring its structural integrity; (2) limiting the loss of conveyance and wastewater treatment capacity due to excessive I/I; and (3) limiting the potential for groundwater contamination by controlling exfiltration from the pipe network. The rehabilitation program should build on information obtained as a result of all forms of maintenance and observations made as part of the capacity evaluation and asset inventory to assure the continued ability of the system to provide sales and service at the least cost. The reviewer should try to gain a sense of how rehabilitation is prioritized. Priorities may be stated in the written program or may be determined through interviews with system personnel.

There are many rehabilitation methods. The choice of methods depends on pipe size, type, location, dimensional changes, sewer flow, material deposition, surface conditions, severity of I/I, and other physical factors. Non-structural repairs typically involve the sealing of leaking joints in otherwise sound pipe.

Structural repairs involve either the replacement of all or a portion of a sewer line, or the lining of the sewer. These repairs can be carried out by excavating usually for repairs limited to one or two pipe segments (these are known as point repairs) or by trenchless technologies (in which repair is carried out via existing manholes or a limited number of access excavations).

The rehabilitation program should identify the methods that have been used in the past, their success rating and methods to be used in the future. An reviewer who wants further guidance on methods of rehabilitation may consult:

Guide for Evaluating CMOM Programs at Sanitary Sewer Collection Systems

- Technology Description from 2004 Report to Congress (EPA 2004)
- *Operation and Maintenance of Wastewater Collection Systems*, Volumes I and II (CSU Sacramento 1996 and 1998)
- *Existing Sewer Evaluation and Rehabilitation* (WEF 1994)

The reviewer should determine the owner's or operator's policies regarding service lateral rehabilitation since service laterals can constitute a serious source of I/I. Manholes should not be neglected in the rehabilitation program. Manhole covers can allow significant inflow to enter the system because they are often located in the path of surface runoff. Manholes themselves can also be a significant source of infiltration from cracks in the barrel of the manhole.

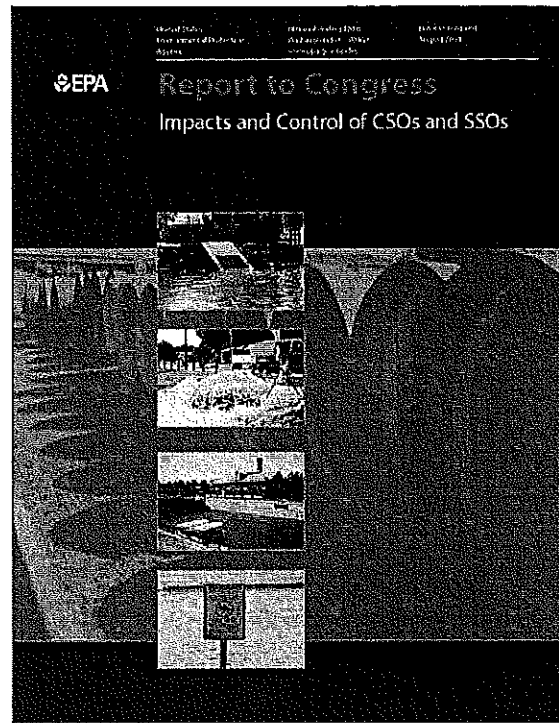

The owner or operator should be able to produce documentation on the location and methods used for sewer rehabilitation. The reviewer should compare the rehabilitation accomplished with that recommended by the capacity evaluation program. When examining the collection system rehabilitation program, the reviewer should be able to answer the following questions:

- Is rehabilitation taking place before it becomes emergency maintenance?
- Are recommendations made as a result of the previously described inspections?
- Does the rehabilitation program take into account the age and condition of the sewers?

CHAPTER 3. CHECKLIST FOR CONDUCTING EVALUATIONS OF WASTEWATER COLLECTION SYSTEM CAPACITY, MANAGEMENT, OPERATION, AND MAINTENANCE (CMOM) PROGRAMS

The following is a comprehensive checklist available for use in the review process. The checklist consists of a series of questions organized by major categories and sub-categories. The major category is followed by a brief statement describing the category. Following the sub-category is a brief clarifying statement. References are then given.

Questions are provided in a table format that includes the question, response, and documentation available.

Response is completed by using information and data acquired from the data and information request, onsite interviews, and site reviews. An alternative to this process is to transmit the entire checklist to the collection system owner or operator to complete and return electronically.

Table of Contents

I.	General Information - Collection System Description	3-4
II.	Continuing Sewer Assessment Plan	3-5
III.	Collection System Management	3-6
	A. Organizational Structure	3-6
	B. Training	3-7
	C. Communication and Customer Service	3-8
	D. Management Information Systems	3-10
	E. SSO Notification Program	3-11
	F. Legal Authority	3-12
IV.	Collection System Operation	3-14
	A. Budgeting	3-14
	B. Compliance	3-16
	C. Water Quality Monitoring	3-17
	D. Hydrogen Sulfide Monitoring and Control	3-18
	E. Safety	3-19
	F. Emergency Preparedness and Response	3-21
	G. Modeling	3-23
	H. Engineering - System Mapping and As-built Plans (Record Drawings)	3-24
	I. Engineering - Design	3-25
	J. Engineering - Capacity	3-26
	K. Engineering - Construction	3-27
	L. Pump Station Operation	3-28
	1. Pump Stations - Inspection	3-29
	2. Pump Stations - Emergencies	3-30
	3. Pump Stations - Emergency Response and Monitoring	3-31
	4. Pump Stations - Recordkeeping	3-32
	5. Pump Stations - Force Mains and Air/Vacuum Valves	3-33
V.	Collection System Maintenance	3-34
	A. Maintenance Budgeting	3-34
	B. Planned Maintenance	3-35
	C. Maintenance Scheduling	3-36
	D. Maintenance Right-of-Way	3-37
	E. Sewer Cleaning	3-38
	1. Sewer Cleaning - Cleaning Equipment	3-39
	2. Sewer Cleaning - Chemical Cleaning and Root Removal	3-40
	F. Parts Inventory	3-41
	G. Equipment and Tools Management	3-42
VI.	Management Information Systems: Performance Indicators	3-43
VII.	Sewer System Capacity Evaluation (SSES)	3-45
	A. Internal TV Inspection	3-45
	B. Survey and Rehabilitation (general)	3-46
	C. Sewer Cleaning Related to I/I Reduction	3-47
	D. Flow Monitoring	3-48
	E. Smoke Testing and Dyed Water Flooding	3-49

	F. Manhole Inspection	3-50
VIII.	Rehabilitation	3-52
	A. Manhole Repairs	3-52
	B. Mainline Sewers	3-53

I. General Information - Collection System Description

Question	Response	Documentation Available	
		Yes	No
Size of service area (acres).			
Population of service area.			
Number of pump stations.			
Feet (or miles) of sewer.			
Age of system (e.g., 30% over 30 years, 20% over 50 years, etc.).			

Comments:

II. Continuing Sewer Assessment Plan

Question	Response	Documentation Available	
		Yes	No
Does the collection system experience problems related to I/I? How do these problems manifest themselves? (Manhole overflows, basement flooding, structure, SSOs)			
How does the owner or operator prioritize investigation, repairs and rehabilitation related to I/I?			
What methods are considered to remedy hydraulic deficiencies?			
Does the plan include a schedule for investigative activities?			
Is the plan regularly updated?			

Comments:

III. A. Collection System Management: Organizational Structure

Question	Response	Documentation Available	
		Yes	No
Is an organizational chart available that shows the overall personnel structure for the collection system, including operation and maintenance staff?			
Are there organizational charts that show functional groups and classifications?			
Are up to date job descriptions available that delineate responsibilities and authority for each position?			
Are the following items discussed in the job descriptions: <input type="checkbox"/> nature of work to be performed, <input type="checkbox"/> minimum requirements for the position, <input type="checkbox"/> necessary special qualifications or certifications, <input type="checkbox"/> examples of the types of work, <input type="checkbox"/> list of licences required for the position, <input type="checkbox"/> performance measures or promotional potential?			
Does the organizational chart indicate how many positions are budgeted as opposed to actually filled?			
On average, how long do positions remain vacant?			
Are collection system staff responsible for any other duties, (e.g., road repair or maintenance, O&M of the storm water collection system)?			

Comments:

III. B. Collection System Management: Training

Question	Response	Documentation Available	
		Yes	No
Is there a documented formal training program?			
Does the training program address the fundamental mission, goals, and policies of the collection system owner or operator?			
Does the owner or operator provide training in the following areas: <input type="checkbox"/> safety, <input type="checkbox"/> routine line maintenance, <input type="checkbox"/> confined space entry, <input type="checkbox"/> traffic control, <input type="checkbox"/> record keeping, <input type="checkbox"/> electrical and instrumentation, <input type="checkbox"/> pipe repair, <input type="checkbox"/> bursting CIPP, <input type="checkbox"/> public relations, <input type="checkbox"/> SSO/emergency response, <input type="checkbox"/> pump station operations and maintenance, <input type="checkbox"/> CCTV and trench/shoring, <input type="checkbox"/> other?			
Which of these programs have formal curriculums?			
Does On-the-Job (OJT) training use Standard Operating and Standard Maintenance Procedures (SOPs & SMPs)?			
Is OJT progress and performance measured?			
Does the owner or operator have mandatory training requirements identified for key employees?			
What percentage of employees met or exceeded their annual training goals during the past year?			
Which of the following methods are used to assess the effectiveness of the training: <input type="checkbox"/> periodic testing, <input type="checkbox"/> drills, <input type="checkbox"/> demonstration, <input type="checkbox"/> none?			
What percentage of the training offered by the owner or operator is in the form of the following: manufacturer training, on-the-job training, in-house classroom training, industry-wide training?			

Comments:

III. C. Collection System Management: Communication and Customer Service

Question	Response	Documentation Available	
		Yes	No
What type of public education/outreach programs does the owner or operator have about user rates?			
Do these programs include communication with groups such as local governments, community groups, the media, schools, youth organizations, senior citizens? List applicable groups.			
Is there a public relations program in place?			
Are the employees of the collection system trained in public relations?			
Are there sample correspondence or "scripts" to help guide staff through written or oral responses to customers?			
What methods are used to notify the public of major construction or maintenance work: <input type="checkbox"/> door hangers, <input type="checkbox"/> newspaper, <input type="checkbox"/> fliers, <input type="checkbox"/> signs, <input type="checkbox"/> other, <input type="checkbox"/> none?			
Is the homeowner notified prior to construction that his/her property may be affected?			
Is information provided to residents on cleanup procedures following basement backups and overflows from manholes when they occur?			
Which of the following methods are used to communicate with system staff: <input type="checkbox"/> regular meetings, <input type="checkbox"/> bulletin boards, <input type="checkbox"/> e-mail, <input type="checkbox"/> other?			
How often are staff meetings held (e.g., daily, weekly, monthly)?			
Are incentives offered to employees for performance improvements?			
Does the owner or operator have an "Employee of the Month/Quarter/Year" program?			

Question	Response	Documentation Available	
		Yes	No
How often are performance reviews conducted (e.g., semi-annually, annually, etc.)?			
Does the owner or operator regularly communicate with other municipal departments?			
Does the owner or operator have a formal procedure in place to evaluate and respond to complaints?			
What are the common complaints received?			
Does the owner or operator have a process for customer evaluation of the services provided?			
Do customer service records include the following information: <input type="checkbox"/> personnel who received the complaint or request, <input type="checkbox"/> nature of complaint or request, <input type="checkbox"/> to whom the follow-up action was assigned, <input type="checkbox"/> date of the complaint or request, <input type="checkbox"/> date the complaint or request was resolved, <input type="checkbox"/> customer contact information, <input type="checkbox"/> location of the problem, <input type="checkbox"/> date the follow-up action was assigned, <input type="checkbox"/> cause of the problem, <input type="checkbox"/> feedback to customer?			
Does the owner or operator have a goal for how quickly customer complaints (or emergency calls) are resolved?			
What percentage of customer complaints (or emergency calls) are resolved within the timeline goals?			
How are complaint records maintained? (i.e., computerized) Is this information used as the basis for other activities such as routine preventative maintenance?			

Comments:

III. D. Collection System Management: Management Information Systems

Question	Response	Documentation Available	
		Yes	No
What types of work reports are prepared by the O&M Staff?			
Do the work reports include enough information? (See example report forms)			
How are records kept?			
Are records maintained for a period of at least three years?			
Are the records able to distinguish activities taken in response to an overflow event?			
Does the owner or operator use computer technology for its management information system? (Computer Based Maintenance Management Systems, spreadsheets, data bases, SCADA, etc). If so, what type of system(s) is used?			
Are there written instructions for managing and tracking the following information: <input type="checkbox"/> complaint work orders, <input type="checkbox"/> scheduled work orders, <input type="checkbox"/> customer service, <input type="checkbox"/> scheduled preventative maintenance, <input type="checkbox"/> scheduled inspections, <input type="checkbox"/> sewer system inventory, <input type="checkbox"/> safety incidents, <input type="checkbox"/> scheduled monitoring/sampling, <input type="checkbox"/> compliance/overflow tracking, <input type="checkbox"/> equipment/tools tracking, <input type="checkbox"/> parts inventory?			
Do the written instructions for tracking procedures include the following information: <input type="checkbox"/> accessing data and information, <input type="checkbox"/> instructions for using the tracking system, <input type="checkbox"/> updating the MIS, <input type="checkbox"/> developing and printing reports?			
How often is the management information system updated (immediately, within one week of the incident, monthly as time permits)?			

Comments:

III. E. Collection System Management: SSO Notification Program

Question	Response	Documentation Available	
		Yes	No
Does the owner or operator have standard procedures for notifying state agencies, health agencies, the regulatory authority, and the drinking water purveyor of overflow events?			
Are above notification procedures dependent on the size or location of the overflow? If so, describe this procedure.			
Is there a Standard form for recording overflow events? Does it include location, type, receiving water, estimated volume, cause?			
Are chronic SSO locations posted?			

Comments:

III. F. Collection System Management: Legal Authority

Question	Response	Documentation Available	
		Yes	No
Does the collection system receive flow from satellite communities?			
What is the total area from satellite communities that contribute flow to the collection system (acres or square miles)?			
Does the owner or operator require satellite communities to enter into an agreement?			
Does the agreement include the requirements listed in the sewer use ordinance (SUO)?			
Do the agreements have a date of termination and allow for renewal under different terms?			
Does the owner or operator maintain the legal authority to control the maximum flow introduced into the collection system from satellite communities?			
Are standards, inspections, and approval for new connections clearly documented in a SUO?			
Does the SUO require satellite communities to adopt the same industrial and commercial regulator discharge limits as the owner or operator?			
Does the SUO require satellite communities to adopt the same inspection and sampling schedules as required by the pretreatment ordinance?			
Does the SUO require the satellite communities or the owner or operator to issue control permits for significant industrial users?			
Does the SUO contain provisions for addressing overstrength wastewater from satellite communities?			
Does the SUO contain procedures for the following: inspection standards, pretreatment requirements, building/sewer permit issues?			

<p>Does the SUO contain general prohibitions of the following materials: <input type="checkbox"/> fire and explosion hazards, <input type="checkbox"/> oils or petroleum, <input type="checkbox"/> corrosive materials, <input type="checkbox"/> materials which may cause interference at the wastewater treatment plant, <input type="checkbox"/> obstructive materials?</p>			
<p>Does the SUO contain procedures and enforcement actions for the following: <input type="checkbox"/> fats, oils, and grease (FOG); <input type="checkbox"/> I/I; building structures over the sewer lines; <input type="checkbox"/> storm water connections to sanitary lines; <input type="checkbox"/> defects in service laterals located on private property; <input type="checkbox"/> sump pumps, air conditioner?</p>			

Comments:

IV. A. Collection System Operation: Budgeting

Question	Response	Documentation Available	
		Yes	No
What are the owner or operator's current rates?			
What is the average annual fee for residential users?			
How are user rates calculated?			
How often are user charges evaluated and adjusted based on that evaluation?			
How many rate changes have there been in the last 10 years and what were they?			
Does the owner or operator receive sufficient funding from its revenues?			
Are collection system enterprise funds used for non-enterprise fund activities?			
Is there a budget for annual operating costs?			
Does the budget provide sufficient line item detail for labor, materials and equipment?			
Are costs for collection system O&M separated from other utility services, i.e., water, storm water and treatment plants?			
Do O&M managers have current O&M budget data?			
What is the collection system's average annual O&M budget?			
What percentage of the collection system's overall budget is allocated to maintenance of the collection system?			
Does the owner or operator have a Capital Improvement Plan (CIP) that provides for system repair/replacement on a prioritized basis?			
What is the collection system's average annual CIP budget?			

Question	Response	Documentation Available	
		Yes	No
What percentage of the maintenance budget is allotted to the following maintenance: Predictive maintenance (tracking design, life span, and scheduled parts replacement), preventative maintenance (identifying and fixing system weakness which, if left unaddressed, could lead to overflows), corrective maintenance (fixing system components that are functioning but not at 100% capacity/efficiency), emergency maintenance (reactive maintenance, overflows, equipment breakdowns).			
Does the owner or operator have a budgeted program for the replacement of under-capacity pipes?			
Does the owner or operator have a budgeted program for the replacement of over-capacity pipes?			
Are O&M staff involved in O&M budget preparation?			
How are priorities determined for budgeting for O&M during the budget process?			
Does the owner or operator maintain a fund for future equipment and infrastructure replacement?			
How is new work typically financed?			

Comments:

IV. B. Collection System Operation: Compliance

Question	Response	Documentation Available	
		Yes	No
Does the owner or operator have inter-jurisdictional or inter-municipal agreements?	Already asked		
Is there a sewer-use and a grease ordinance?			
Is there a process in place for enforcing sewer and grease ordinances?			
Are all grease traps inspected regularly?			
How does the owner or operator learn of new or existing unknown grease traps?			
Who is responsible for enforcing the sewer ordinance and grease ordinance? Does this party communicate with the utility department on a regular basis?			
Are there any significant industrial dischargers to the system?			
Is there a pretreatment program in place? If so, please describe.			
Is there an ordinance dealing with private service laterals?			
Is there an ordinance dealing with storm water connections or requirements to remove storm water connections?			

Comments:

IV. C. Collection System Operation: Water Quality Monitoring

Question	Response	Documentation Available	
		Yes	No
Is there a water quality monitoring program in the service areas?			
If so, who performs the monitoring?			
How many locations are monitored?			
What parameters are monitored and how often?			
Is water quality monitored after an SSO event?			
Are there written standard sampling procedures available?			
Is analysis performed in-house or by a contract laboratory?			
Are chain-of-custody forms used?			

Comments:

IV. D. Collection System Operation: Hydrogen Sulfide Monitoring and Control

Question	Response	Documentation Available	
		Yes	No
Are odors a frequent source of complaints? How many?			
Are the locations of the frequent odor complaints documented?			
What is the typical sewer slope? Does the owner or operator take hydrogen sulfide corrosion into consideration when designing sewers?			
Does the collection system owner or operator have a hydrogen sulfide problem, and if so, does it have in place corrosion control programs? What are the major elements of the program?			
Does the owner or operator have written procedures for the application of chemical dosages?			
Are chemical dosages, dates, and locations documented?			
Does the owner or operator have a program in place for renewing or replacing severely corroded sewer lines to prevent collapse?			
Are the following methods used for hydrogen sulfide control: <input type="checkbox"/> aeration, <input type="checkbox"/> iron salts, <input type="checkbox"/> enzymes, <input type="checkbox"/> activated charcoal canisters, <input type="checkbox"/> chlorine, <input type="checkbox"/> sodium hydroxide, <input type="checkbox"/> hydrogen peroxide, <input type="checkbox"/> potassium permanganate, <input type="checkbox"/> biofiltration, <input type="checkbox"/> others?			
Does the system contain air relief valves at the high points of the force main system?			
How often are the valves maintained and inspected (weekly, monthly, etc.)?			
Does the owner or operator enforce pretreatment requirements?			

Comments:

IV. E. Collection System Operation: Safety

Question	Response	Documentation Available
		Yes No
Is there a documented safety program supported by the top administration official?		
Is there a Safety Department that provides training, equipment, and an evaluation of procedures?		
If not, who provides safety training?		
Does the owner or operator have written procedures for the following: <input type="checkbox"/> lockout/tagout, <input type="checkbox"/> MSDS, <input type="checkbox"/> chemical handling, <input type="checkbox"/> confined spaces permit program, <input type="checkbox"/> trenching and excavations, <input type="checkbox"/> biological hazards in wastewater, <input type="checkbox"/> traffic control and work site safety, <input type="checkbox"/> electrical and mechanical systems, <input type="checkbox"/> pneumatic and hydraulic systems safety?		
What is the agency's lost-time injury rate(percent or in hours)?		
Is there a permit required confined space entry procedure for manholes, wetwells, etc.? Are confined spaces clearly marked?		
Are the following equipment items available and in adequate supply: <input type="checkbox"/> rubber/disposable gloves; <input type="checkbox"/> confined space ventilation equipment; <input type="checkbox"/> hard hats, <input type="checkbox"/> safety glasses, <input type="checkbox"/> rubber boots; <input type="checkbox"/> antibacterial soap and first aid kit; <input type="checkbox"/> tripods or non-entry rescue equipment; <input type="checkbox"/> fire extinguishers; <input type="checkbox"/> equipment to enter manholes; <input type="checkbox"/> portable crane/hoist; <input type="checkbox"/> atmospheric testing equipment and gas detectors; <input type="checkbox"/> oxygen sensors; <input type="checkbox"/> H ₂ S monitors; <input type="checkbox"/> full body harness; <input type="checkbox"/> protective clothing; <input type="checkbox"/> traffic/public access control equipment; <input type="checkbox"/> 5-minute escape breathing devices; <input type="checkbox"/> life preservers for lagoons; <input type="checkbox"/> safety buoy at activated sludge plants; <input type="checkbox"/> fiberglass or wooden ladders for electrical work; <input type="checkbox"/> respirators and/or self-contained breathing apparatus; <input type="checkbox"/> methane gas or OVA analyzer; <input type="checkbox"/> LEL metering?		
Are safety monitors clearly identified?		
How often are safety procedures reviewed and revised?		

Question	Response	Documentation Available	
		Yes	No
Are workplace accidents investigated?			
How does the Administration communicate with field personnel on safety procedures; memo, direct communication, video, etc.?			
Is there a Safety Committee with participation by O&M staff? How often does it meet?			
Is there a formal Safety Training Program? Are records of training maintained?			

Comments:

IV. F. Collection System Operation: Emergency Preparedness and Response

Question	Response	Documentation Available	
		Yes	No
Does the owner or operator have an emergency response plan? A contingency plan?			
How often is the plan reviewed and updated? What was the date it was last updated?			
Does the plan take into consideration vulnerable points in the system, severe natural events, failure of critical system components, vandalism or other third party events, and a root cause analysis protocol?			
Are staff trained and drilled to respond to emergency situations? Are responsibilities detailed for all personnel who respond to emergencies?			
Are there emergency operation procedures for equipment and processes?			
Does the owner or operator have standard procedures for notifying state agencies, local health departments, the regulatory authority, and drinking water authorities of significant overflow events?			
Does the procedure include an up-to-date list of the names, titles, phone numbers, and responsibilities of all personnel involved?			
Do work crews have immediate access to tools and equipment during emergencies?			
Is there a public notification plan? If so, does it cover both regular business hours and off-hours?			
Does the owner or operator have procedures to limit public access to and contact with areas affected with SSOs?			
Does the owner or operator use containment techniques to protect the storm drainage systems?			

<p>Do the overflow records include the following information: <input type="checkbox"/> date and time, <input type="checkbox"/> cause(s), <input type="checkbox"/> names of affected receiving water(s), <input type="checkbox"/> location, <input type="checkbox"/> how it was stopped, <input type="checkbox"/> any remediation efforts, <input type="checkbox"/> estimated flow/volume discharged, <input type="checkbox"/> duration of overflow?</p>			
<p>Does the owner or operator have signage to keep public from affected area?</p>			
<p>Is there a hazard classification system? Where is it located?</p>			
<p>Does the owner or operator conduct vulnerability analyses?</p>			
<p>Are risk assessments performed? How often?</p>			

Comments:

IV. G. Collection System Operation: Modeling

Question	Response	Documentation Available	
		Yes	No
Does the owner or operator have a hydraulic model of the collection system including pump stations? What model is used?			
What uses does the model serve (predicting flow capacity, peak flows, force main pressures, etc.)?			
Does the model produce results consistent with observed conditions?			
Is the model kept up to date with respect to new construction and repairs that may affect hydraulic capacity?			

Comments:

IV. H. Collection System Operation: Engineering - System Mapping and As-built Plans (Record Drawings)

Question	Response	Documentation Available	
		Yes	No
What type of mapping/inventory system is used?			
Is the mapping tied to a GPS system?			
Are "as-built" plans (record drawings) or maps available for use by field crews in the office and in the field?			
Do field crews record changes or inaccuracies and is there a process in place to update "as built" plans (record drawings)?			
Do the maps show the date the map was drafted and the date of the last revision?			
Do the sewer line maps include the following: <input type="checkbox"/> scale; <input type="checkbox"/> north arrow; <input type="checkbox"/> date the map was drafted; <input type="checkbox"/> date of the last revision; <input type="checkbox"/> service area boundaries; <input type="checkbox"/> property lines; <input type="checkbox"/> other landmarks; <input type="checkbox"/> manhole and other access points; <input type="checkbox"/> location of building laterals; <input type="checkbox"/> street names; <input type="checkbox"/> SSOs/CSOs; <input type="checkbox"/> flow monitors; <input type="checkbox"/> force mains; <input type="checkbox"/> pump stations; <input type="checkbox"/> lined sewers; <input type="checkbox"/> main, trunk, and interceptor sewers; <input type="checkbox"/> easement lines and dimensions; <input type="checkbox"/> pipe material; <input type="checkbox"/> pipe diameter; <input type="checkbox"/> pipe invert elevation; <input type="checkbox"/> installation date; <input type="checkbox"/> slope; <input type="checkbox"/> manhole rim elevation; <input type="checkbox"/> manhole coordinates; <input type="checkbox"/> manhole invert elevation; <input type="checkbox"/> distance between manholes?			
Are the following sewer attributes recorded: <input type="checkbox"/> size, <input type="checkbox"/> shape, <input type="checkbox"/> invert elevation, <input type="checkbox"/> material, <input type="checkbox"/> separate/combined sewer, <input type="checkbox"/> installation date?			
Are the following manhole attributes recorded: <input type="checkbox"/> shape, <input type="checkbox"/> type, <input type="checkbox"/> depth, <input type="checkbox"/> age, <input type="checkbox"/> material?			
Is there a systematic numbering and identification method/system established to identify sewer system manhole, sewer lines, and other items (pump stations, etc.)?			

Comments:

IV. I. Collection System Operation: Engineering - Design

Question	Response	Documentation Available	
		Yes	No
Is there a document which details design criteria and standard construction details?			
Is life cycle cost analysis performed as part of the design process?			
Is there a document that describes the procedures that the owner or operator follows in conducting design review? Are there any standard forms that are used as a guide?			
Are O&M staff involved in the design review process?			
Does the owner or operator have documentation on private service lateral design and inspection standards?			
Does the owner or operator attempt to standardize equipment and sewer system components?			

Comments:

IV. J. Collection System Operation: Engineering - Capacity

Question	Response	Documentation Available	
		Yes	No
What procedures are used in determining whether the capacity of existing gravity sewer system, pump stations and force mains are adequate for new connections?			
Is any metering of flow performed prior to allowing new connections?			
Is there a hydraulic model of the system used to predict the effects of new connections?			
Is there any certification as to the adequacy of the sewer system to carry additional flow from new connections required?			

Comments:

IV. K. Collection System Operation: Engineering - Construction

Question	Response	Documentation Available	
		Yes	No
Who constructs new sewers? If other than the owner or operator, does the owner or operator review and approve the design?			
Is there a document that describes the procedures that the owner or operator follows in conducting their construction inspection and testing program?			
Are there any standard forms that guide the owner or operator in conducting their construction inspection and testing program?			
Is new construction inspected by the owner or operator or others?			
What are the qualifications of the inspector(s)?			
What percentage of time is a construction inspector on site?			
Is inspection supervision provided by a registered professional engineer?			
How is the new gravity sewer construction tested? (Air, water, weirs, etc.)			
Are new manholes tested for inflow and infiltration?			
Are new gravity sewers televised?			
What tests are performed on pump stations?			
What tests are performed on force mains?			
Is new construction built to standard specifications established by the owner or operator and/or the State?			
Is there a warranty for new construction? If so, is there a warranty inspection done at the end of this period?			

Comments:

IV. L. Collection System Operation: Pump Station Operation

Question	Response	Documentation Available	
		Yes	No
How many pump stations are in the system? How many have backup power sources?			
Are enough trained personnel assigned to properly maintain pump stations?			
Are these personnel assigned full-time or part-time to pump station duties?			
Are there manned and un-manned pump stations in the system? How many of each?			
Is there a procedure for manipulating pump operations (manually or automatically during wet weather to increase in-line storage of wet weather flows?			
Are well-operating levels set to limit pump start/stops?			
Are the lead, lag, and backup pumps rotated regularly?			

Comments:

IV. L. 1. Collection System Operation: Pump Stations - Inspection

Question	Response	Documentation Available	
		Yes	No
How often are pump stations inspected?			
What work is accomplished during inspections?			
Is there a checklist?			
Are records maintained for each inspection?			
What are the average annual labor hours spent on pump station inspections?			
Are there Standard Operating Procedures (SOPs) and Standard Maintenance Procedures (SMPs) for each station?			
What are the critical operating characteristics maintained for each station? Are the stations maintained within these criteria?			

Comments:

IV. L. 2. Collection System Operation: Pump Stations - Emergencies

Question	Response	Documentation Available	
		Yes	No
Is there an Emergency Operating Procedure for each pump station?			
Is there sufficient redundancy of equipment in all pump stations?			
Who responds to lift station failures and overflows? How are they notified?			
How is loss of power at a station dealt with? (i.e. on-site electrical generators, alternate power source, portable electric generator(s))			
What equipment is available for pump station bypass?			
What process is used to investigate the cause of pump station failure and take necessary action to prevent future failures?			

Comments:

IV. L. 3. Collection System Operation: Pump Stations - Emergency Response and Monitoring

Question	Response	Documentation Available	
		Yes	No
How are lift stations monitored?			
If a SCADA system is used, what parameters are monitored?			

Comments:

IV. L. 4. Collection System Operation: Pump Stations - Recordkeeping

Question	Response	Documentation Available	
		Yes	No
Are operations logs maintained for all pump stations?			
Are manufacturer's specifications and equipment manuals available for all equipment?			
Are pump run times maintained for all pumps?			
Are elapsed time meters used to assess performance?			

Comments:

IV. L. 5. Collection System Operation: Pump Stations - Force Mains and Air/Vacuum Valves

Question	Response	Documentation Available	
		Yes	No
Does the owner or operator regularly inspect the route of force mains?			
Does the owner or operator have a program to regularly assess force main condition?			
Is there a process in place to investigate the cause of force main failures?			
Does the owner or operator have a regular maintenance/inspection program for air/vacuum valves?			
Have force main failures been caused by water hammer?			

Comments:

V. A. Equipment and Collection System Maintenance: Maintenance Budgeting

Question	Response	Documentation Available	
		Yes	No
How does the collection system owner or operator track yearly maintenance costs?			
Is there a maintenance cost control system?			
Are maintenance costs developed from past cost records?			
How does the owner or operator categorize costs? Preventive? Corrective? Projected Costs? Projected Repair?			
How does the owner or operator control expenditures?			

Comments:

V. B. Equipment and Collection System Maintenance: Planned Maintenance

Question	Response	Documentation Available	
		Yes	No
Are preventive maintenance tasks and frequencies established for all pump stations and equipment?			
How were preventive maintenance frequencies established?			
What percentage of the operator's time is devoted to planned as opposed to unplanned maintenance?			
What predictive maintenance techniques are used as part of PM program?			
Is there a formal procedure to repair or replace pump stations and equipment when useful life is reached?			
Has an energy audit been performed on pump station electrical usage?			
Is an adequate parts inventory maintained for all equipment?			
Is there a sufficient number of trained personnel to properly maintain all stations?			
Who performs mechanical and electrical maintenance?			
Are there Standard Maintenance Procedures (SMPs) for each station?			

Comments:

V. C. Equipment and Collection System Maintenance: Maintenance Scheduling

Question	Response	Documentation Available	
		Yes	No
Does the owner or operator plan and schedule preventive and corrective maintenance activities?			
Is there an established priority system? Who sets priorities for maintenance?			
Is a maintenance card or record kept for each piece of mechanical equipment within the collection system?			
Do equipment maintenance records include the following information: <input type="checkbox"/> maintenance recommendations, <input type="checkbox"/> instructions on conducting the specific maintenance activity, <input type="checkbox"/> other observations on the equipment, <input type="checkbox"/> maintenance schedule, <input type="checkbox"/> a record of maintenance on the equipment to date.			
Are dated tags used to show out-of-service equipment?			
Is maintenance backlog tracked?			
How is O&M performance tracked and measured?			
What percent of repair finds are spent on emergency repairs?			
Are corrective repair work orders backlogged more than six months?			
Is maintenance performed for other public works divisions?			
How are priorities determined for this work?			
How is this work funded?			
Are maintenance logs maintained for all pump stations?			

Comments:

V. D. Equipment and Collection System Maintenance: Maintenance Right-of-Way

Question	Response	Documentation Available	
		Yes	No
Does the owner or operator perform scheduled maintenance on Rights-of-Way and Easements?			
Does the owner or operator monitor street paving projects?			
Does the owner or operator have a program to locate and raise manholes (air valves, etc) as needed?			
How are priorities determined?			
How is the effectiveness of the maintenance schedule measured?			

Comments:

V. E. Equipment and Collection System Maintenance: Sewer Cleaning

Question	Response	Documentation Available	
		Yes	No
Is there a routine schedule for cleaning sewer lines on a system wide basis, e.g., at the rate of once every seven to twelve years or a rate of between 8% and 14% per year?			
What is the owner or operator's goals for annual system cleaning?			
What percent of the sewer lines are cleaned, even high/repeat cleaning trouble spots, during the past year?			
Is there a program to identify sewer line segments that have chronic problems and should be cleaned on a more frequent schedule?			
What is the average number of stoppages experienced per mile of sewer pipe per year?			
Has the number of stoppages increased, decreased, or stayed the same over the past five years?			
Are stoppages diagnosed to determine the cause?			
Are stoppages plotted on maps and correlated with other data such as pipe size and material, or location?			
Do the sewer cleaning records include the following information: <input type="checkbox"/> date and time, <input type="checkbox"/> cause of stoppage, <input type="checkbox"/> method of cleaning, location of stoppage or routine cleaning activity, <input type="checkbox"/> identity of cleaning crew, <input type="checkbox"/> further actions necessary/initiated?			
If sewer cleaning is done by a contractor are videos taken of before and after cleaning?			

Comments:

V. E. 1. Equipment and Collection System Maintenance: Sewer Cleaning - Cleaning Equipment

Question	Response	Documentation Available	
		Yes	No
What type of cleaning equipment does the owner or operator use?			
How many cleaning units of each type does the owner or operator have? What is the age of each?			
How many cleaning crews and shifts does the owner or operator employ?			
How many cleaning crews are dedicated to preventive maintenance cleaning?			
How many cleaning crews are dedicated to corrective maintenance cleaning?			
What has the owner or operator's experience been regarding pipe damage caused by mechanical equipment?			
Where is the equipment stationed?			

Comments:

V. E. 2. Equipment and Collection System Maintenance: Sewer Cleaning - Chemical Cleaning and Root Removal

Question	Response	Documentation Available	
		Yes	No
Does the owner or operator have a root control program?			
Does the owner or operator have a FOG program?			
Are chemical cleaners used?			
What types of chemical cleaners are used?			
How often are they applied?			
How are the chemical cleaners applied?			
What results are achieved through the use of chemical cleaners?			

Comments:

V. F. Equipment and Collection System Maintenance: Parts Inventory

Question	Response	Documentation Available	
		Yes	No
Does the owner or operator have a central location for the storage of spare parts?			
Have critical spare parts been identified?			
Are adequate supplies on hand to allow for two point repairs in any part if the system?			
Is there a parts standardization policy in place?			
Does the owner or operator maintain a stock of spare parts on its maintenance vehicles?			
What method(s) does the owner or operator employ to keep track of the location, usage, and ordering of spare parts? Are parts logged out when taken by maintenance personnel for use?			
Does the owner or operator salvage specific equipment parts when equipment is placed out-of-service and not replaced?			
How often does the owner or operator conduct a check of the inventory of parts to ensure that their tracking system is working?			
Who has the responsibility of tracking the inventory?			
For those parts which are not kept in inventory, does the owner or operator have a readily available source or supplier?			

Comments:

V. G. Equipment and Collection System Maintenance: Equipment and Tools Management

Question	Response	Documentation Available	
		Yes	No
Is there a list of equipment and tools used for operation and maintenance?			
Do personnel feel they have access to the necessary equipment and tools to do all aspects of operation and maintenance of the collection system?			
Is there access to suitable equipment if the owner or operator's equipment is down for repair?			
Does the owner or operator own or have access to portable generators?			
Where does the owner or operator store its equipment?			
Is a detailed equipment maintenance log kept?			
Are written equipment maintenance procedures available?			
What is the procedure for equipment replacement?			
Are the services of an in-house vehicle and equipment maintenance services used?			
What is the typical turnaround time for equipment and vehicle maintenance?			

Comments:

VI. Management Information Systems: Performance Indicators

Question	Response	Documentation Available	
		Yes	No
How many sanitary sewer overflows (SSOs) have occurred in the last 5 years? How many less than 1,000 gallons?			
Does the owner or operator document and report all SSOs regardless of size?			
Does the owner or operator document basement backups?			
Are there areas that experience basement or street flooding?			
How many SSOs have reached "Waters of the US"? Is there a record?			
Approximately, what percent of SSOs discharge were from each of the following in the last 5 years: manholes, pump stations, main and trunk sewers, lateral and branch sewers, structural bypasses?			
What is the per capita wastewater flow for the maximum month and maximum week or day?			
What is average annual influent BOD?			
What is the ratio of maximum wet weather flow to average dry weather flow?			
Approximately, what percent of SSO discharge were caused by the following in the last 5 years: debris buildup, collapsed pipe, root intrusion, capacity limitations, excessive infiltration and inflow, FOG, vandalism?			
What percent of SSOs were released to: soil; surface water; basements; paved areas; coastal, ocean, or beach areas; rivers, lakes or streams?			
For surface water releases, what percent are to surface waters that could affect: contact recreation, shellfish growing areas, drinking water sources?			
How many chronic SSO locations are in the collection system?			

Are pipes with chronic SSOs being monitored for sufficient capacity and/or structural condition?			
Prior to collapse, are structurally deteriorating pipelines being monitored for renewal or replacement?			
What is the annual number of mainline sewer cave-ins? What was the cause (i.e. pipe corrosion, leaks, etc.)			
What other types of performance indicators does the owner or operator use?			

Comments:

VII. A. Sewer System Capacity Evaluation (SSES): Internal TV Inspection

Question	Response	Documentation Available	
		Yes	No
Does the owner or operator use internal T.V. inspection? If so please describe the program.			
Do the internal TV record logs include the following: <input type="checkbox"/> pipe size, type, length, and joint spacings; <input type="checkbox"/> distance recorded by internal TV; <input type="checkbox"/> results of the internal TV inspection; <input type="checkbox"/> internal TV operator name; <input type="checkbox"/> cleanliness of the line; <input type="checkbox"/> location and identification of line being televised by manholes?			
Is a rating system used to determine the severity of the defects found during the inspection process?			
Is there documentation explaining the codes used for internal TV results reporting?			
Approximately what percent of the total defects determined by TV inspection during the past 5 years were the following:			
Are main line and lateral repairs checked by internal TV inspection after the repair(s) have been made?			

Comments:

VII. B. SSES: Survey and Rehabilitation (general)

Question	Response	Documentation Available	
		Yes	No
Have SSES's been performed in the past? If so, is documentation available?			
Has any sewer rehabilitation work been done in the past 15 years? If so, please describe?			
Does the owner or operator have standard procedures for performing SSES work?			
Do the SSES reports include recommendations for rehabilitation, replacement, and repair?			
Were defects identified in the SSES repaired?			
Does the owner or operator have a multi-year Capital Improvements Program that includes rehabilitation, replacement, and repair?			
How are priorities established for rehabilitation, replacement, and repair?			
Has the owner or operator established schedules for performing recommended rehabilitation, both short term and long term?			
Has funding been approved for the recommended rehabilitation?			
Is post rehabilitation flow monitoring used to assess the success of the rehabilitation?			

Comments:

VII. C. SSES: Sewer Cleaning Related to I/I Reduction

Question	Response	Documentation Available	
		Yes	No
Are sewers cleaned prior to flow monitoring?			
Are sewers cleaned prior to internal T.V. inspection?			
When cleaning, is debris removed from the system?			

Comments:

VII. D. SSES: Flow Monitoring

Question	Response	Documentation Available	
		Yes	No
Does the owner or operator have a flow monitoring program? If so, please describe.			
Does the owner or operator have a comprehensive capacity assessment and planning program?			
Are flows measured prior to allowing new connections?			
Number of permanent meters? Number of temporary meters?			
What type(s) of meters are used?			
Number of rain gauges?			
How frequently are flow meters checked?			
Do the flow meter checks include: <input type="checkbox"/> independent water level, <input type="checkbox"/> checking the desiccant, <input type="checkbox"/> velocity reading, <input type="checkbox"/> cleaning away debris, <input type="checkbox"/> downloading data, <input type="checkbox"/> battery condition?			
Are records maintained for each inspection?			
Do the flow monitoring records include: <input type="checkbox"/> descriptive location of flow meter, <input type="checkbox"/> type of flow meter, <input type="checkbox"/> frequency of flow meter inspection, <input type="checkbox"/> frequency of flow meter calibration?			
Are flow data used for billing, capacity analysis, and/or I/A investigations?			
What is the ratio of peak wet weather flow to average dry weather flow at the wastewater treatment plant?			
Does the owner or operator have any wet weather capacity problems?			
Are low points or flood-plain areas monitored during rain events?			
Does the owner or operator have any dry weather capacity problems?			

VII. E. SSES: Smoke Testing and Dyed Water Flooding

Question	Response	Documentation Available	
		Yes	No
Does the owner or operator have a smoke testing program to identify sources of inflow and infiltration into the system including private service laterals and illegal connections? If so please describe.			
Are there written procedures for the frequency and schedule of smoke testing?			
Is there a documented procedure for isolating line segments?			
Is there a documented procedure for notifying local residents that smoke testing will be conducted in the area?			
What is the guideline for the maximum amount of line to be tested at one time?			
Are there guidelines for the weather conditions under which smoke testing should be conducted?			
Do the written records contain location, address, and description of the smoking element that produced a positive result?			
What follow-up occurs as a result of positive results for smoke or dye testing?			
Is there a goal for the percent of the system smoke tested each year?			
What percent of the system has been smoke tested over the past year?			
Does the owner or operator have a dyed water flooding program If so please describe.			
Is there a goal for the percent of the system dye tested each year?			
What percent of the system has been dye tested over the past year?			
Does the owner or operator share smoke and dye testing equipment with another owner or operator?			

Comments:

VII. F. SSES: Manhole Inspection

Question	Response	Documentation Available	
		Yes	No
Does the owner or operator have a routine manhole inspection and assessment program?			
What is the purpose of the inspection program?			
Does the owner or operator have a goal for the number of manholes inspected annually?			
How many manholes were inspected during the past year?			
Do the records for manhole/pipe inspection include the following: <input type="checkbox"/> conditions of the frame and cover; <input type="checkbox"/> evidence of surcharge; offsets or misalignments; <input type="checkbox"/> atmospheric hazards measurements; <input type="checkbox"/> details on the root cause of cracks or breaks in the manhole or pipe including blockages; <input type="checkbox"/> recording conditions of corbel, walls, bench, trough, and pipe seals; <input type="checkbox"/> presence of corrosion, if repair is necessary; <input type="checkbox"/> manhole identifying number/location; wastewater flow characteristics; <input type="checkbox"/> accumulations of grease, debris, or grit; presence of infiltration, location, and estimated quantity; <input type="checkbox"/> inflow from manhole covers?			
Are manholes susceptible to inflow identified and inspected on a regular frequency?			
Is there a data management system for tracking manhole inspection activities?			
What triggers whether a manhole needs rehabilitation?			
Does the owner or operator have a multi-year Capital Improvements Program that includes rehabilitation, replacement, and repair of manholes?			
How are priorities established for rehabilitation, replacement, and repair of manholes?			
Has the owner or operator established schedules for performing rehabilitation, both short term and long term of manholes?			

Question	Response	Documentation Available	
		Yes	No
Has funding been approved for the rehabilitation of manholes?			
Does the owner or operator have a grouting program?			

Comments:

VIII. A. Rehabilitation: Manhole Repairs

Question	Response	Documentation Available	
		Yes	No
What rehabilitation techniques are used for manhole repairs?			
How are priorities determined for manhole repairs?			
What type of documentation is kept?			
Does the owner or operator use manhole inserts?			
Are they used system wide or only on low lying manholes?			

Comments:

VIII. B. Rehabilitation: Mainline Sewers

Question	Response	Documentation Available	
		Yes	No
What type of main line repairs has the owner or operator used in the past?			
Does the owner or operator currently use any of above techniques for main line repairs? What other techniques is the owner or operator presently using?			
How are priorities established for main line repairs?			
What type of follow-up is performed after the repair (e.g., CCTV)?			

Comments:

Appendix A

EXAMPLE

COLLECTION SYSTEM PERFORMANCE

INDICATOR DATA

COLLECTION FORM

EXAMPLE

COLLECTION SYSTEM PERFORMANCE INDICATOR DATA COLLECTION FORM

I. General Information

- A. Agency Name _____
- B. Agency Address
Street _____
City _____ State _____ Zip _____
- C. Contact Person _____
- D. Telephone: Voice _____ Fax _____ Email _____
- E. Data provided for latest fiscal/calendar year, 20__

II. Collection System Description

- A. Service Area _____ Square miles
- B. Population Served _____
- C. System Inventory

Miles of gravity sewer	Miles of force main	Number of maintenance access structures	Number of pump stations	Number of siphons	Number of air, vacuum, or air/vacuum relief valves

- D. Number of Service Connections:
Residential _____ Commercial _____ Industrial _____ Total _____
- E. Lateral Responsibility (check one)
1. At main line connection only _____
 2. From main line to property line or easement/cleanout _____
 3. Beyond property line/cleanout _____
 4. Other _____
- F. System combined (storm and sanitary)? Yes ___ No ___ If yes, % combined ____
- G. Average Annual Precipitation _____ inches
- H. System Flow Characteristics (total for service area)

Peak Dry Weather Flow (MGD)	Peak Wet Weather Flow (MGD)	Average Daily Flow (MGD)

III. Special Conditions

A. Indicate local conditions that are accounted for during design, construction, operation, and maintenance of the collection system.

1. Precipitation: Yes ___ No ___ If yes, provide brief explanation _____
2. Terrain: Yes ___ No ___ If yes, provide brief explanation _____
3. Soils: Yes ___ No ___ If yes, provide brief explanation _____
4. Temperature: Yes ___ No ___ If yes, provide brief explanation _____
5. Groundwater: Yes ___ No ___ If yes, provide brief explanation _____
6. Geology: Yes ___ No ___ If yes, provide brief explanation _____
7. Other: _____

- | | | |
|----|--|----------------|
| B. | Is corrosion a significant problem? | Yes ___ No ___ |
| | • Is there a corrosion control program in place? | Yes ___ No ___ |
| C. | Is odor a significant problem? | Yes ___ No ___ |
| | • Is there an odor control program in place? | Yes ___ No ___ |
| D. | Is grease a significant problem? | Yes ___ No ___ |
| | • Is there a grease control program in place? | Yes ___ No ___ |
| E. | Are roots a significant problem? | Yes ___ No ___ |
| | • Is there a root control program in place? | Yes ___ No ___ |

IV. Age Distribution of Collection System

Age	Gravity Sewer, miles	Force Mains, miles or feet	Number of Pump Stations
0 - 25 years			
26 - 50 years			
51 - 75 years			
> 76 years			

V. Size Distribution of Collection System

Diameter in inches	Gravity Sewer, miles	Force Mains, miles or feet
8 inches or less		
9 - 18 inches		
19 - 36 inches		
> 36 inches		

VI. Distribution of Gravity Sewer By Material

- A. Vitrified Clay Pipe (VCP) _____ Miles
- B. Reinforced Concrete Pipe (RCP) _____ Miles
- C. Unreinforced Concrete Pipe (CP) _____ Miles
- D. Plastic (all types) _____ Miles
- E. Brick _____ Miles
- F. Other _____ Miles
- G. Other _____ Miles
- H. Other _____ Miles

VII. Distribution of Force Mains By Material

- A. Reinforced Concrete Pipe (RCP) _____ (circle one) miles or feet
- B. Prestressed Concrete Cylinder Pipe (PCCP) _____ miles or feet
- C. Asbestos Cement Pipe (ACP) _____ miles or feet
- D. Polyvinyl Chloride (PVC) _____ miles or feet
- E. Steel _____ miles or feet
- F. Ductile Iron _____ miles or feet
- G. Cast Iron _____ miles or feet
- H. Techite (RPMP) _____ miles or feet
- I. High Density Polyethylene (HDPE) _____ miles or feet
- J. Fiberglass Reinforced Plastic (FRP) _____ miles or feet
- K. Other _____ miles or feet

VIII. Preventive Maintenance of System

A. Physical Inspection of Collection System, Preventive Maintenance

Inspection Activity	Total Annual Labor Hours Expended for This Activity	Total Completed (Miles of Pipe or Manholes Inspected Annually)	Crew Size (s)
CCTV			
Visual Manhole Inspection, Surface Only			
Visual Manhole Inspection, Remove Cover			
Visual Gravity Line Inspection, Surface Only			
Visual Force Main Inspection, Surface Only			
Other (Sonar, etc.)			

B. Mechanical and Hydraulic Cleaning, Preventive Maintenance

Cleaning Activity	Total Annual Labor Hours Expended for This Activity	Total Annual Labor Hours Expended for Scheduled PM	Total Miles Cleaned Annually	Crew Size (s)	Range of Pipe Diameters Cleaned
Hydraulic Jet					
Bails, Kites, Scooters					
Combination Machines					
Rod Machines					
Hand Rodding					
Bucket Machines					
Chemical Root Control					
Chemical or Biological Grease Control					

IX. Dry Weather Stoppages

- A. Number of stoppages, annually _____
- B. Average time to clear stoppage _____
- C. Number of stoppages resulting in overflows and/or backups annually _____
- D. Total quantity of overflow(s) _____
- E. Is there an established procedure for problem diagnosis? Yes ___ No ___
- F. Are future preventive measures initiated based on diagnosis? Yes ___ No ___
- G. What equipment is available for emergency response? _____

X. Repairs and Rehabilitation, Proactive

- A. Number of annual spot repairs identified _____
- B. Number of annual spot repairs completed _____
- C. Percent of spot repairs contracted _____
- D. Number of manholes identified for rehabilitation _____
- E. Number of manholes rehabilitated annually _____
- F. Percent of manhole repairs contracted _____
- G. Feet of main line needing rehabilitation _____
- H. Feet of main line rehabilitated _____
- I. Percent of main line rehabilitation contracted _____
- J. Number of manholes scheduled for rehabilitation under Capital Improvement Program (s) _____
- K. Feet of main line scheduled for rehabilitation under Capital Improvement Program (s) _____

XI. Repairs and Rehabilitation, Reactive

- A. Number of annual line features _____
- B. Number of line repairs _____

XII. Pump Stations

- A. Number of pump stations inspected _____
 - Frequency of inspections _____ (daily, every other day, weekly)
- B. Number of inspection crews _____
- C. Crew size _____
- D. Number of pump stations with pump capacity redundancy _____
- E. Number of pump stations with backup power sources _____
- F. Number of pump stations with dry weather capacity limitations _____
- G. Number of pump stations with wet weather capacity limitations _____
- H. Number of pump stations calibrated annually _____
- I. Number of pump stations with permanent flowmeters _____
- J. Number of pump stations with remote status monitoring _____
- K. Number of pump stations with running time meters _____
- L. Number of mechanical maintenance staff assigned to mechanical maintenance _____
- M. Number of electrical maintenance staff assigned to electrical maintenance _____
- N. Total labor hours scheduled annually for electrical and mechanical PM tasks _____
- O. Total labor hours expended annually for electrical and mechanical PM tasks _____

XIII. Pump Station Failures, Dry Weather

- A. Number of failures resulting in overflows/bypass or backup, annually _____
- B. Total quantity of overflow/bypass _____ Gallons or MG
- C. Average time to restore operational capability _____ hours
- D. Total labor hours expended for electrical and mechanical corrective maintenance tasks _____
- E. Is failure mode and effect diagnosed? Yes ___ No ___
- F. Are future preventive measures initiated based on diagnosis? Yes ___ No ___
- G. What equipment is available for emergency response? _____

XIV. Force Mains

- A. Force mains inspected annually _____ miles or feet (visual surface inspection of alignment)
 - B. Force mains monitored annually _____ miles or feet (pressure profile, capacity)
 - C. Number of force main failures annually _____
 - D. Cause(s) of force main failures _____
-

XV. Air Relief/Vacuum Valves

- A. What is frequency of valve inspections? _____
 - B. What is frequency of PM (backflushing, etc)? _____
 - C. Number of annual valve failures _____
 - D. Cause(s) of valve failures _____
-

XVI. System Operation and Maintenance Efficiency

- A. Total full time or full time equivalent staff assigned to O & M (excluding administration staff but including line managers, supervisors) _____
- B. Total estimated labor hours actually expended for active O & M tasks (this is the total above less hours for sick, vacation, holidays, training, breaks, etc., not directly related to performing O & M tasks) _____

XVII. Level of Service

- A. Average annual rate for residential users _____
- B. Rate based on: water consumption _____ Flat rate _____ Other _____
- C. Number of complaints annually _____
- D. Number of complaints that are agency responsibility _____
- E. Number of public health or other warnings issued annually _____
- F. Number of claims for damages due to backups annually _____
- G. Total cost of claims settled annually _____

XVIII. Financial

- A. Total annual revenue received from wastewater _____
 - 1. % of revenue for long-term debt _____
 - 2. % of revenue for treatment and disposal _____
 - 3. % of revenue for collection and conveyance _____
- B. Current value of collection system assets _____
- C. Annual O & M expenditure _____
- D. Annual CIP expenditure for repair, replacement, or rehabilitation _____
- E. Annual O & M training budget _____
- F. Total number of O & M personnel (including administrative in O & M department) _____
- G. Number of personnel with collection system certification _____
- H. Number of personnel qualified for collection system certification _____
- I. Amount of O & M budget allocated for contracted services _____
- J. Hydroflush cost per foot _____
- K. Rodding cost per foot _____
- L. Bucketing cost per foot _____
- M. CCTV cost per foot _____
- N. Spot repairs, cost each _____

XIX. Safety

- A. Total labor hours assigned to O & M _____
- B. Number of lost time injuries _____
- C. Total lost time days _____
- D. Total cost of lost time injuries _____

XX. Regulatory

- A. Total number of violations issued annually _____
- B. Total cost of fines paid annually _____
- C. What is minimum reportable quantity in gallons? _____
- D. What is time reporting requirement? _____
- E. Number of annual WWTP upsets due to wet weather flow _____

XXI. General

- A. Has SSES been performed on system? Yes _____ No _____
- B. Total O & M positions currently budgeted _____
- C. Total O & M positions currently filled _____
- D. Is computerized maintenance management system (s) used for O & M managing? Yes ___ No ___

- E. Is GIS system used for O & M managing? Yes _____ No _____

XXII. Procedures or Other Documentation Available

- A. Overflow, bypass and containment Yes _____ No _____
- B. Problem evaluation and solution Yes _____ No _____
- C. Cleanup procedure Yes _____ No _____
- D. Failure mode and effect procedure Yes _____ No _____
- E. O & M budget process Yes _____ No _____
- F. O & M budget with line item detail Yes _____ No _____
- G. Long-range CIP planning for system expansion, rehabilitation, and replacement Yes _____ No _____
- H. Is there a written procedure for cleanup to mitigate effect of overflow? Yes _____ No _____
- I. Is there a written procedure for containing overflows and bypasses? Yes _____ No _____
- J. Is there an established procedure for containing overflows and bypasses? Yes _____ No _____
- K. Is there an established procedure for problem evaluation and solution? Yes _____ No _____
- L. Is there an established procedure for cleanup to mitigate effect of overflow? Yes _____ No _____
- M. Is there a grease control program? Yes _____ No _____
- N. Is there a pretreatment program? Yes _____ No _____
- O. Is there a private source I/I reduction program? Yes _____ No _____
- P. Do you have chronic O & M problems that are designed into your system? Yes _____ No _____
If yes, provide brief description _____

- Q. Do you have chronic O & M problems that are constructed into your system? Yes _____ No _____
If yes, provide brief description _____

- R. How would you rate your construction inspection program?
Very effective _____ Needs improvement _____ Poor _____

XXIII. Definitions/Clarifications

- A. Maintenance access structures, most commonly manholes, in your system that are incorporated into your O & M program.
- B. Pump capacity redundancy is the ability to maintain pumping at design capacity with the largest pump out of service.
- C. Remote status monitoring is any remote monitoring system such as alarm telemetry or SCADA that provides remote pump station status information.
- D. You will notice that in the section on stoppages and pump station failures, we are asking for dry weather incidents only. Dry weather system performance is a good indicator or effectiveness of O & M program. If you have wet weather information that you wish to provide also, please do.
- E. Under the Special Conditions sections we are identifying conditions that are present in your system that require consideration during design, construction, and O & M of your system.

- F. Any of the questions dealing with labor hours are designed to determine total labor hours irrespective of crew size or crews that are only assigned to cleaning, for example, less than full time.
- G. Our goal is to obtain data that can be or are standardized and that are accurate. We also realize that some data may not be available; however, data can be accurately estimated. If you estimate data please follow with an (E).
- H. If data is not available please indicate "NA." If data does not apply to your system, please indicate by "DNA."
- I. Failure mode and effect refers to any established procedure you have to diagnose system failures to determine the cause and effect of the failure. This can apply to crews clearing stoppages or to pump station failures.
- J. Pump station inspection (XII) means scheduled inspection by operators to verify station operation and perform PM. It excludes electrical or mechanical craft maintenance.
- K. Stoppage in section IX refers only to stoppages other than pump stations. Pump stations are covered in Section XIII. Backup in this case refers to a basement or other structure backup as opposed to main line sewer backup.

XXIV. Additional Comments

Appendix B
EXAMPLE INTERVIEW SCHEDULE
AND TOPICS

EXAMPLE INTERVIEW SCHEDULE AND TOPICS

Days 1 and 2 Interviews

Work Practice or Maintenance Function	Description	Examples of Discussion Topics and Supporting Documents	Name	Interview Date, Time, and Location
Senior Management	<p>Discuss project expectations, report review and comment process.</p> <p>Overview of organizational structure and "culture".</p> <p>Identify sensitive issues and how to approach.</p> <p>Schedule</p>			
Project Kick off Meeting	<p>Overview and purpose of project.</p> <p>Interview and field assessment process.</p> <p>Report content and review process.</p> <p>Questions and answers</p>	None		
Physical Inspection and Testing – Gravity sewer system	<p>Visual Inspection, pipe alignment.</p> <p>CCTV</p> <p>Smoke and Dye Testing</p> <p>Other</p>	<p>Reports, inspection forms, performance data, inspection strategy, crew assignments and schedules, equipment available, current expenditures and budgeted amounts, area maps, Standard Operating Procedures, field maps.</p>		

Work Practice or Maintenance Function	Description	Examples of Discussion Topics and Supporting Documents	Name	Interview Date, Time, and Location
Preventive Maintenance - Mechanical and hydraulic cleaning	High velocity jets and combination machines. Other hydraulic methods Rodding Machines Bucket Machines	Reports, performance data, preventive maintenance cleaning strategy, crew assignments and schedules, equipment available, current and budgeted, problem areas, Standard Operating Procedures, Standard Maintenance Procedures, problem diagnosis		
Chemical and biological cleaning	Root control Grease control Odor control Corrosion control	Grease control ordinance, enforcement, odor and corrosion control strategy, root control program, design for O&M considerations, materials used (MSDS), reports, performance data, preventive maintenance cleaning strategy, crew assignments and schedules, equipment available, current and budgeted, problem areas, Standard Operating Procedures, Standard Maintenance Procedures, problem diagnosis, public education, enforcement		
Pump Stations	Routine inspection Electrical and mechanical maintenance SCADA Standby/emergency systems Valves Forcemains	Logs, inspection sheets, Standard Maintenance Procedures, Standard Operating procedures, pump station inventory and attribute data base, spares inventory, Reports, performance data, preventive maintenance strategy, crew assignments and schedules, equipment available, current and budgeted, critical pump stations, Standard Operating Procedures, Standard Maintenance Procedures, problem diagnosis, preventive and predictive maintenance methods, maintenance tasks and frequencies, O&M manuals, capacity issues		

Work Practice or Maintenance Function	Description	Examples of Discussion Topics and Supporting Documents	Name	Interview Date, Time, and Location
Training and Certification	<p>Training program, technical, supervisory and management.</p> <p>Certification program</p>	<p>Knowledge, skills and abilities, basic skills, career paths, minimum qualifications, certification, educational assistance program, internal and external training, OJT, training budget</p>		
Work Management	<p>Planning and scheduling work</p> <p>Materials management</p> <p>Priority</p> <p>Backlog management</p> <p>Procurement</p> <p>Manual or Computer Maintenance Management System (CMMS)</p>	<p>Complaints and emergencies normal hours and after hours.</p> <p>Corrective, preventive and predictive maintenance work orders, work backlog, labor utilization, reports,</p>		

Work Practice or Maintenance Function	Description	Examples of Discussion Topics and Supporting Documents	Name	Interview Date, Time, and Location
Safety	<p>Safety committee</p> <p>Safety meetings</p> <p>Safety enforcement</p> <p>Documentation of comprehensive safety training</p> <p>Compliance with safety regulations</p> <p>Documentation of effectiveness of safety program (e.g., reduction of accidents)</p> <p>Documentation of attendance and learning at safety training sessions</p>	<p>Policy and procedures for trenching, confined space, lockout tagout, PPE. Safety manual, formal training, tracking, accident investigation</p>		
Financial	<p>Annual O&M Budget</p> <p>Rates</p> <p>CIP for rehabilitation/rehab</p> <p>Non-enterprise fund allocations</p>	<p>O&M budget process, line item accounts, five year CIP plan, repair, rehabilitation, replacement strategy for pipes and pump stations</p>		

Work Practice or Maintenance Function	Description	Examples of Discussion Topics and Supporting Documents	Name	Interview Date, Time, and Location
Construction and Repair	Emergency repair Spot repairs, gravity system Rehabilitation Lateral installation Inspection New Construction Testing	Reports, inspection forms, performance data, inspection strategy, crew assignments and schedules, equipment available, current and budgeted, area maps, Standard Operating Procedures, field maps,		
Fleet Management	Maintenance Replacement Availability Budgeting	Inventory, repair and replacement process, maintenance turn around time, preventive maintenance, Standard Operating Procedures, Standard Maintenance Procedures, CMMS,		

Day 3 - Field

Pump Stations

Work Practice or Maintenance Function	Description	Examples of Discussion Topics and Supporting Documents	Name	Interview Date, Time and Location
Pump Station Maintenance	<p>Submersible</p> <p>Cast in place wet well dry well</p> <p>Prefabricated</p> <p>Grinder/Low Pressure System</p>	<p>Logs, O&M manuals, on-site procedures, vehicles and equipment, SCADA, Supervisory controls, electrical systems, flow meters, HVAC, variable speed systems, chronic problems, pumps and hydraulic systems.</p>		

Day 4 – Field

Facilities and Crews

Work Practice or Maintenance Function	Description	Examples of Discussion Topics and Supporting Documents	Name	Interview Date, Time and Location
Facilities	<p>Electrical and mechanical repair shops and equipment</p> <p>Warehouse and equipment storage areas</p> <p>Vehicle maintenance shops</p> <p>Crew areas; locker rooms, training areas, dispatch areas</p>	<p>Logs, O&M manuals, on-site procedures, vehicles and equipment, SCADA, Supervisory controls, electrical systems, flow meters, HVAC, variable speed systems, chronic problems, pumps and hydraulic systems,</p>		
Crews	<p>CCTV</p> <p>Cleaning</p> <p>Construction Repair</p> <p>Overview of findings for week</p>	<p>N/A</p> <p>None</p>		
Exit Interview				

Appendix C

INFORMATION SOURCES

Information Sources
(Updated November 2004)

WEBSITES (water and/or wastewater-oriented; financial related)

EPA National Compliance Assistance Clearinghouse	www.epa.gov/clearinghouse
Compliance Assistance Centers	http://www.assistancecenters.net
Construction Industry Compliance Assistance Center	www.cicacenter.org
EPA NPDES website	http://www.epa.gov/npdes
EPA Operator On-Site Technical Assistance Program--104(g) (hands-on assistance to small municipal WWTP operators at no cost to community)	www.epa.gov/owm/mab/smcomm/104g/sstc.htm
EPA Office of Wastewater Management	www.epa.gov/owm
EPA Clean Water Tribal Grant Program	www.epa.gov/owm/mab/indian/cwisa.htm
EPA Colonias Program	www.epa.gov/owm/mab/mexican
EPA Clean Water State Revolving Loan Fund Program	www.epa.gov/owm/cwfinance/cwsrf
EPA Website (Headquarters & Regions)	www.epa.gov/
EPA Small Business Gateway	http://www.epa.gov/smallbusiness
Environmental Finance Center	http://sspa.boisestate.edu/efc
National Environmental Services Center/WV University	www.nesc.wvu.edu
Local Govt. Environmental Assistance Network	www.lgean.org
Rural Community Assistance Program (RCAP)	www.rcap.org
Water Environment Federation (WEF)	www.wef.org
AMSA	www.amsa-cleanwater.org/pubs/
American Water Works Assoc. (AWWA)	http://www.awwa.org/
National Association of Towns & Townships (NATAT)	http://www.natat.org/

PUBLICATIONS /TRAINING VIDEOS /NEWSLETTERS, etc.

EPA National Service Center For Environmental Publications (NSCEP)
USEPA/NSCEP
PO Box 42419
Cincinnati, OH 45242
Tele: 1-800-490-9198 or 513-489-8190 (fax: 513-489-8695)

EPA Office of Water Resource Center
Tele: 202-566-1729 (24 hours)
center.water-resources@epa.gov

National Environmental Services Center (formerly the National Small Flows Clearinghouse)
West Virginia University Small Business Gateway
P.O. Box 6064
Morgantown, WV 26506
Tele: 1-800-624-8301

California State University - Sacramento
Tele: 916-278-6142
(training videos, etc.)

List Compiled by Sharie Centilla, USEPA/OECA
centilla.sharie@epa.gov
33

REFERENCES

California State University (CSU) Sacramento. 1996. Operation and Maintenance of Wastewater Collection Systems. Volume I, Fifth Ed. Prepared for EPA, Office of Water Programs Operations. Sacramento, CA: California State University, Sacramento Foundation.

California State University (CSU) Sacramento. 1998. Operation and Maintenance of Wastewater Collection Systems. Volume II, Fifth Ed. Prepared for EPA, Office of Water Programs Operations. Sacramento, CA: California State University, Sacramento Foundation.

U.S. EPA National Enforcement Investigations Center (NEIC). 1992. Multi-media Investigations Manual. EPA-330/9-89-003-R.

U.S. Environmental Protection Agency. 1974. "Process Design Manual for Sulfide Control in Sanitary Sewerage Systems." Prepared for the Technology Transfer Office of the U.S. Environmental Protection Agency. EPA 625/1-74-005. pg. 3-27.

U.S. EPA Office of Water. 1973. *Manpower Requirements for Wastewater Collection Systems in Cities and Towns of up to 150,000 Population*. EPA-832-R-73-104.

U. S. EPA Office of Water. 1974. *Manpower Requirements for Wastewater Collection Systems in Cities of 150,000 to 500,000 Population*. EPA-832-R-74-102.

U.S. EPA Office of Water. 1983. *Procedures Manual for Reviewing a POTW Pretreatment Program Submission*. EPA-833-B-83-200.

U.S. EPA Office of Water. 1985. *Design Manual: Odor and Corrosion Control in Sanitary Sewerage Systems and Treatment Plants*. EPA-625-1-85-018.

U.S. EPA Office of Water. 2004. NPDES Compliance Inspection Manual. EPA-305-X-03-004.

U.S. EPA Office of Water. 2004. *Report to Congress: Impacts and Controls on CSOs and SSOs*. EPA-833-R-04-001.

Water Environment Federation. 1994. *Existing Sewer Evaluation & Rehabilitation: WEF Manual of Practice FD-6, ASCE Manuals and Reports on Engineering Practice No. 62*. Alexandria, VA: WEF.

**EPA Region 4
Introduction to Conducting Evaluations
of
Municipal Wastewater Collection System
Management, Operation, and Maintenance Programs**

Version 1.0



PURPOSE & DISCLAIMER

This document is the work product of the EPA Region 4, Water Management Division, Water Programs Enforcement Branch (WPEB) and supercedes a 10-30-1996 draft previously released. This document serves as an introduction for new Region 4 inspectors in the WPEB Municipal Infrastructure Enforcement Program and as introductory information for utilities invited to participate in the Region 4 Management, Operation, and Maintenance (MOM) Programs Project. Questions in this document are provided to initiate the thought process necessary for conducting an evaluation of a collection system. Formal instruction for conducting an evaluation under the MOM Programs Project is provided in separate literature.

The MOM Programs Project is conducted in compliance with EPA Policy, EPA Guidance, and Rules and Regulations promulgated under the Clean Water Act. If some statement or part of the document is not in compliance with the Act, EPA Policy, EPA Guidance or the Rules and Regulations, then it should not be construed as conveying rights not conveyed by the Clean Water Act, EPA Policy, or the Rules and Regulations.

September 2003

Introduction

Many collection systems have received minimal maintenance for many years. This has resulted in deteriorated sewers with a high potential for overflows, cave-ins, hydraulic overloads at treatment plants, and other problems. There are two central reasons for conducting an evaluation of a municipal collection system:

Public and Environmental Health

Sanitary sewer overflows (SSOs) are a frequent cause of water quality violations. Beach closings, flooded basements, closed shellfish beds, and overloaded water treatment plants are a few of the symptoms of an inadequate collection system. Streams influenced by frequent SSOs support only the hardiest of species.



Legal Considerations

A discharge permit issued through the National Pollutant Discharge Elimination System (NPDES) requires that the "permittee shall at all times properly operate and maintain all facilities and systems of treatment and control (and related appurtenances) that are installed or used by the permittee to achieve compliance with the conditions of this permit." SSOs may be considered a violation of this permit provision.

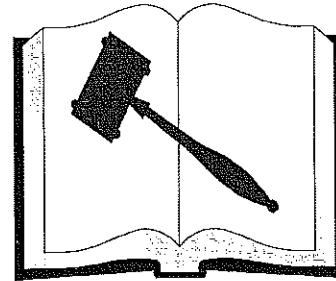

SSOs may also be considered an unpermitted discharge of pollutants from a point source, as defined in the Clean Water Act.

A goal of the collection system evaluation should be to discover if a utility is plagued by overflows and/or bypasses within its system of conveyance to a treatment facility. If so, what are the impacts? Is the utility aware of the problem? Are they taking appropriate steps to address the problem in a timely manner and prevent future reoccurrence?

Management

The first stop on any evaluation should be the "home office." This location is a point of administration, and may include functions such as utility management, finance, engineering, planning, procurement, warehousing, personnel, or legal review. In a large city, this work may be split between different departments. A small town may have only one or two people doing some of these activities. Much of the information needed from this source can be obtained before the evaluation by a written request. Areas of review should include:

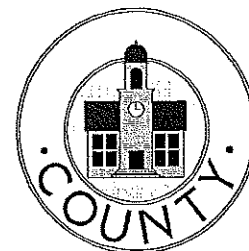

✓ *Financial Administration*

EPA and others have published guidance on the financial aspects of operating a wastewater utility. This is the single most important aspect of utility operation. Inadequate funding diminishes the chances for success.

User Rate/User Charge

- ! What are the utility's current rates?
- ! How are user rates calculated?
- ! How often are user charges adjusted based on that evaluation?
- ! Does the utility receive full funding from its revenue?
- ! Are utility funds used for other government activities?

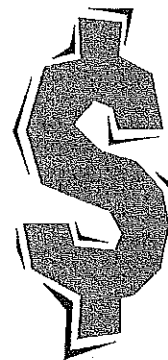

Budget

The utility should be operating on an annual budget that details funding for all functions.

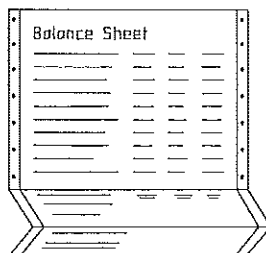

- ! Does the utility budget for annual operating costs?
- ! Does the budget provide sufficient itemization?
- ! Does the utility maintain a fund for future equipment and infrastructure replacement? How is work financed?

! Does the budget provide for sufficient funding?

Public Education/Outreach

The utility should be talking with the public on issues such as user rates and charges. It is up to the utility to educate the public on wastewater treatment, its impact on water resources, and the importance of keeping the user rates current. By maximizing resources and operating facilities efficiently, the utility may be able to delay increases in user rates for a short time. Adjustments for more efficient operation should be made before approaching the public on these issues.



! What type of public education/outreach programs does the utility have about the use of income from utility rates?

! Do these programs include communication with several groups such as local governments, community groups, the media, young people (schools, youth organizations)?

✓ Personnel Administration

Organization

! Is an organizational chart available which shows the various positions budgeted and filled?

! Are position descriptions available?

Operator Safety Program

A utility can have several levels of a safety program. It should consist of top administration, a safety department, a safety committee, and field personnel. For a small utility, top administration could be the mayor while a large utility could employ a personnel manager. All utilities should have a safety program that includes a safety policy, safety training and promotion, and accident investigation and reporting.

! Is there a documented safety program supported by a top administration official?

! Is there a safety department that provides training,



equipment, and an evaluation of procedures?

- ! Are all operators required to follow safe work procedures, such as the use of protective clothing and headgear, confined spaces, lock-out/tag-out policies, etc.?
- ! Is there a confined space entry procedure for manholes, wet wells, etc.?
- ! How often are safety procedures reviewed and revised?
- ! Does the safety department communicate with field personnel on safety by a procedures memo, direct communication, a video, etc.?

✓ *Equipment and Tools Administration*

The amount and types of equipment and tools held by a utility depend on the size, age, and condition of the system. The decision as to the type and amount of equipment to have on hand is a difficult one. A small utility may find it hard to justify the purchase of expensive, specialized equipment. The utility must identify the problems in the collection system and arrange for the appropriate tools and equipment accordingly. An alternative to purchasing is leasing, contracting, or sharing costs with other communities.

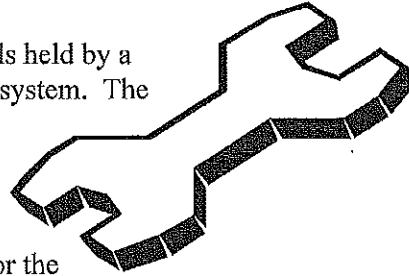

- ! Is there a list of equipment and tools used for operation and maintenance?
- ! Do field personnel feel they have access to the necessary equipment and tools to do all aspects of the operation and maintenance of its collection system?
- ! Is there access to suitable equipment if the utility's equipment is down for repair?
- ! Does the utility own or have ready access to a sufficient number of emergency power generators?
- ! Where does the utility store its equipment?
- ! Is a detailed equipment maintenance log kept?
- ! Are written equipment maintenance procedures available?

! What is the procedure for equipment replacement?

! If an in-house motor pool is used, what is the turnaround time for service?

Equipment that has reached its useful life should be replaced. To reduce the financial burden of equipment replacement, a fund should be established for equipment replacement. A utility should keep detailed records on the cost of operating the equipment to make good decisions about equipment replacement.

✓ *Legal Administration*

The utility should have legal documents to protect its collection system. Typically, sewer ordinances exist to satisfy Clean Water Act pretreatment regulations and to assure the utility's compliance with its NPDES permit. A legally sound sewer ordinance will give the utility retribution when corrosive and/or toxic materials are introduced into the collection system. Another important element is a grease control ordinance. Grease traps should be inspected by the utility for compliance. Some utilities choose to permit each trap owner.

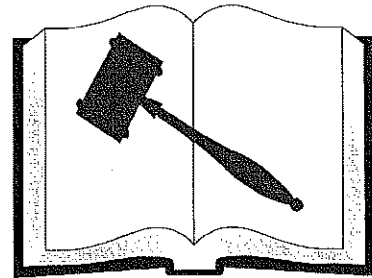

! Is there a sewer use and a grease control ordinance?

! Is there active enforcement of the sewer and grease control ordinances?

! Are all grease traps inspected regularly?

! How does the utility learn of new or existing grease traps?

! Who is responsible for enforcing the sewer ordinance and grease ordinance? Does this party communicate with the utility department on a regular basis?

! Are there any significant industrial dischargers to the system?

! Is there a pretreatment program in place?

✓ *Engineering Administration*

System Mapping and As-Built Plans

The utility should have an overall map of the collection system with sufficient detail to allow easy interpretation. There should be a collection system inventory organized by plant service areas that include the following information:

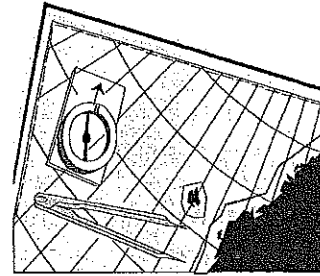

Gravity Lines:	Lineal feet by diameter
Manholes:	Number
Pump Stations:	Number by type
Force Mains:	Lineal feet by diameter
Air Release Valves:	Number and location
Inverted Syphons:	Number and location
Other Major Appurtenances:	Number and location
Service Population	By facility service area

A sewer atlas detailing the location of the above items should be available. The type of sewer atlas used by the utility will depend on their needs and resources. A large metropolitan utility may find that a sophisticated, computerized mapping system is required. A small community may be satisfied with a hand-drafted version.

! What type of mapping/inventory system is used?

! Is there a procedure for recording changes and updating the mapping system?

Mapping and inventory revisions should occur when there are changes in the collection system such as additions or repairs. Comprehensive maps of the system should be printed annually for large utilities, and a staff of "mappers" will likely be required to keep the maps up to date. Utilities may alternatively choose to contract map services. This is especially true if much catch-up work is required.

Design and Capacity Analysis

Through the interview and document review process, the evaluator should discover design procedures and the criteria needed for new work. In particular, the evaluator should discover how the utility determines the adequacy of the existing system for transmitting and treating future flows. The evaluator should discover what control the utility has over new connections to the system.

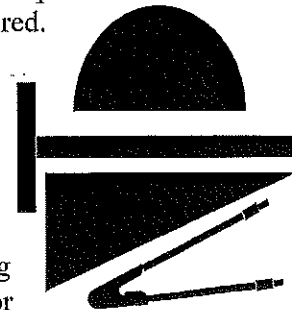

- ! Is there a document which details the design criteria and standard construction details for gravity sewers, force mains, and pump stations?
- ! Is there a document that describes the procedures that the utility follows in conducting a design review? Are there any standard forms that guide the utility?
- ! What procedures are used in determining whether the existing sewer system capacity is adequate for new connections?
- ! Is any flow metering accomplished prior to allowing new connections?
- ! Is there a mathematical model of flow in the system used to predict the effects of new connections?
- ! Is any certification required which attests capacity is available for a new connection before it is made?

Construction

Through the interview and document review process, the evaluator should determine what procedures the utility uses to inspect and test new construction. These activities are important to ensure that new facilities do not contribute to future operation and maintenance problems. Excessive infiltration and inflow problems can exist with new construction if not properly built.

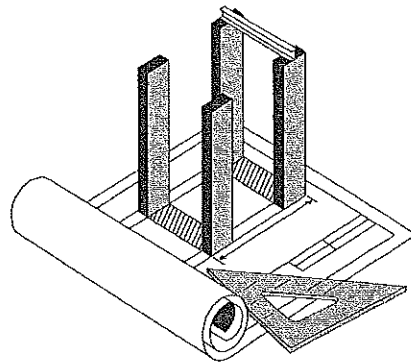

- ! Is there a document that describes the procedures that the utility follows in conducting their construction inspection and testing program? Are there any standard forms that guide the utility in conducting their construction inspection and testing program?
- ! Is new construction inspected by the utility or others?
- ! What are the qualifications of the inspector(s)?
- ! Is inspection supervision provided by a registered Professional Engineer?
- ! How is new construction tested? (air, water, weirs, etc.)
- ! Is new construction televised using closed-circuit camera techniques?
- ! Is new construction built to standard specs set by the local utility and/or the State?

! Is there a warranty for new construction? If so, is there a warranty inspection done at the end of this period?

Sewer System Evaluation Survey (SSES) and Rehabilitation

The SSES and sewer rehabilitation program is a structured methodology for finding the holes in a system and fixing them. Cost analysis is the major factor in determining the scope of rehabilitation. Due to the requirements of EPA's Construction Grants Program, many systems did evaluation surveys as a condition of their grant. Some systems also received grant funds for rehabilitation.

The SSES is a two-phase operation. The first phase is to gather preliminary information and technical data. Flow monitoring, records and map evaluations, and system inspection are some of the tasks to be completed. Prioritizing areas for further evaluation is the end result of phase one.

The second phase is to conduct further testing of the prioritized sewer areas identified in the preliminary phase and analyze these results. Rehabilitation recommendations based on a cost-effective analysis is the end result of phase two and concludes the SSES.

Rehabilitation may consist of a variety of techniques designed to reduce inflow and infiltration into the sewer system. Many methods are available with highly variable costs and service lives. Rehabilitation costs are usually significantly less than replacement costs.

SSES and rehabilitation activities are best described as a highly intensive program of operation and maintenance. Because over time many utilities have neglected proactive operation and maintenance of their sewer systems, these activities are often used to "catch-up" to a condition which can be maintained on a regular basis. Many of the techniques used in SSES and rehabilitation activities are described in the Operation and Maintenance section of this document, and should also be elements found in a proactive operation and maintenance program.

! Have SSES activities been performed in the past? If so, is documentation available?

! Has any sewer rehabilitation work been done in the past 15 years?

! How many sanitary sewer overflows have occurred in the last year?

! Is there a record?

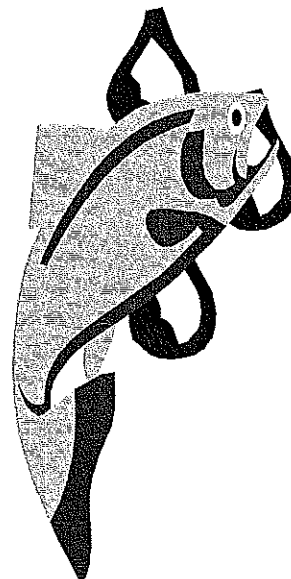

✓ *Water Quality Monitoring*

Monitoring streams in the service areas can help identify problems in the collection system such as leaking pipes, washed-out stream crossings, and other pollution sources which could be attributed to the sewer system. Fecal Coliform is a common parameter monitored to detect potential contamination from sewers.

- ! Is there a water quality monitoring program in the service areas?
- ! If so, what parameters are monitored and at what frequency?
- ! How many locations are monitored?

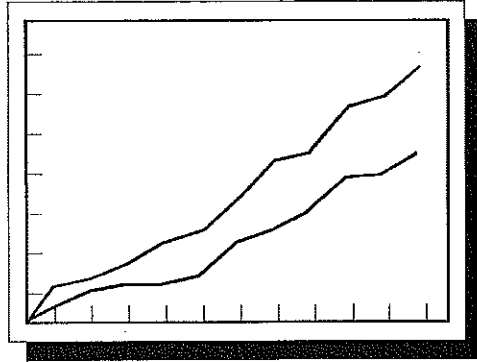

✓ *Management Information Systems*

A management information system uses data from work reports prepared by field personnel to optimize the operation and maintenance of the collection system. A powerful tool, the information system is used as an aide to schedule preventive and reactive work on the system. It can also be used to measure efficiency, and track and develop costs.

- ! What types of work reports are prepared by the field personnel?

Examples include:

- Main Sewer Construction
- Main Sewer Maintenance
- Main Sewer Repair
- Structure Maintenance
- Structure Repair or Abandonment
- Building Sewer Maintenance
- Building Sewer Repair

- ! Do the work reports include complete and useful information?
- ! How are records kept?
- ! Does the facility use computer software to manage information? If so, what type of systems are used?

! What kind of management reports are generated from the work report data?

Examples include:

- Payroll
- Production
- Work Costs
- System Inventory
- Main line maintenance history
- Service line maintenance history
- Main and service line repair history

Performance Indicators

Performance indicators are used to determine the condition of the system. These indicators are not absolute because there may be other reasons to suggest a less than adequate system condition. However, if several of the factors indicate possible problems, further investigation is warranted.

! What is the per capita wastewater flow for the maximum month, week, and day?

EPA considers Infiltration/Inflow (I/I) to be excessive if the total daily flow during periods of high groundwater exceeds 120 gallons per capita per day (gpcd), and during a storm event exceeds 275 gpcd.

! What is average annual BOD of the treatment facility influent?

An average of much less than 200 mg/L may indicate excessive I/I.

! What is the ratio of maximum wet weather flow to average dry weather flow?

A review of 10 case studies by EPA found that peak wet weather flow ranged from 3.5 to 20 times the average dry weather flow. Typically, as the ratio approaches 4 to 5, the likelihood of surcharge and overflow increases.

! What is the annual number of overflows, and what are the causes (i.e., grease blockages, debris blockages, pump malfunctions, overloaded sewers, lift station power loss, etc.)?

! What is the annual number of sewer cave-ins? What were the causes (i.e., pipe corrosion, root intrusion, leaks, etc.)

✓ *Complaints*

- ! How are public complaints handled?
- ! What are the common complaints received?
- ! How often are these complaints reported?
- ! Is there a record?
- ! Does the utility have a procedure in place to evaluate and respond to complaints?

✓ *Public Relations*

- ! Is there a public relations program in place?
- ! Are the employees of the utility trained in public relations?
- ! What type of public notification is given for treatment plant upsets or collection system overflows?
- ! Is the public notified prior to major construction or maintenance work?
- ! How often does the utility communicate with other municipal departments?

✓ *Emergency Maintenance and/or Contingency Plans*

- ! Does the utility have a written emergency maintenance plan?
- ! What type of equipment does the utility have available for emergency maintenance?
How quickly can the utility access that equipment in case of an emergency?

✓ *Spare Parts Inventory Management*

- ! Does the utility have a central location for the storage of spare parts?
- ! Have spare parts which are difficult to obtain, but critical to operation been identified?
- ! Does the utility maintain a stock of common spare parts on its maintenance vehicles?

- ! What methods are employed to keep track of the location, usage, and reordering of spare parts? Are parts logged out when taken by maintenance personnel for use?
- ! Does the utility salvage specific equipment parts when equipment is placed out of service and not replaced?
- ! How often does the utility conduct a check of the inventory of parts to ensure their tracking system is working?
- ! Who has the responsibility to track the inventory?

Operation and Maintenance

The operation and maintenance (O&M) of a wastewater collection system is a difficult undertaking. Besides keeping the system in good working order, a proper O&M program should convey all wastewater to the treatment plant. A well-operated system will employ many, if not all, of the techniques described in this section.

✓ *Maintenance Scheduling*

- ! Does the utility schedule its maintenance activities?
- ! How are priorities determined?
- ! How is the effectiveness of the maintenance schedule measured?

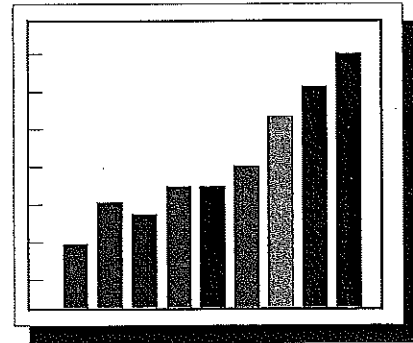

✓ *Sewer Cleaning*

Sewer utilities have been cleaning lines for a long time. Most sewer cleaning programs have been directed towards emergency situations which occur due to stoppages. A better O&M program will have regular cleaning schedules for the system.

- ! Is there a routine schedule established for cleaning sewer lines on a system-wide basis (e.g., "once every seven to twelve years," or "between 8% and 14% per year"?)

- ! Is there a process present to identify sewer line segments that have chronic problems and that should be cleaned on a more frequent schedule?

Cleaning Equipment

Mechanical cleaning equipment, such as a rodding device or bucket machine, has been the mainstay of utility cleaning operations for a long time. Though this type of equipment is still in use, hydraulic cleaning equipment which uses water pressure directed through a nozzle has generally replaced the need for mechanical equipment.

- ! What type of cleaning equipment does the sewer utility use?
- ! How many cleaning units of each type does the utility have?
- ! How many cleaning crews and shifts does the utility employ?
- ! How many cleaning crews are dedicated to routine cleaning?
- ! How many cleaning crews are dedicated to emergency cleaning?
- ! What has the utility's experience been regarding pipe damage caused by mechanical cleaning equipment?
- ! Where is the cleaning equipment stationed?

Chemical Cleaning and Root Removal

Roots are a major cause of stoppages in many systems, so root removal and control is an important utility operation.

- ! Does the utility have a root control program?
- ! Are chemical cleaners used? What types?
- ! How often are they applied?
- ! How are the chemical cleaners applied?
- ! What results are achieved through the use of chemical cleaners?

✓ *Hydrogen Sulfide Monitoring and Control*

The presence of hydrogen sulfide gas in gravity and pressure sewer lines can, and often does, lead to serious and catastrophic corrosion of concrete pipes and the metallic components of sewer systems. Hydrogen sulfide corrosion is usually a problem in areas having little topographic relief where there may be long travel times. Hydrogen sulfide corrosion can also be a problem downstream from pump stations having long wet well holding times.

- ! Are odors a frequent source of complaints?
- ! Has the sewer utility verified the existence/non-existence of a hydrogen sulfide problem, and if one is present, does it have in place corrosion control programs?
- ! What are the major elements of the utility's program?

A control program could be use of chemicals or aeration to prevent the formation of hydrogen sulfide. Pipe materials which resists corrosion are also effective. Often, a combination of approaches will be included in a program.

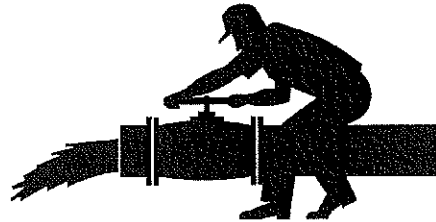

✓ *Lift Stations*

Lift stations are an important part of most wastewater systems. In coastal or other areas with little topographical relief, lift stations are a major O&M item. The effects of deteriorated collection systems are often realized at lift stations in the form of severe overflows during rain events.

Operation

- ! How many personnel are detailed to pump station operations and maintenance?
- ! Are these personnel assigned full-time or part-time to pump station duties?
- ! Is there sufficient redundancy of equipment?

Emergencies

- ! Who responds to lift station overflows? How are they notified?

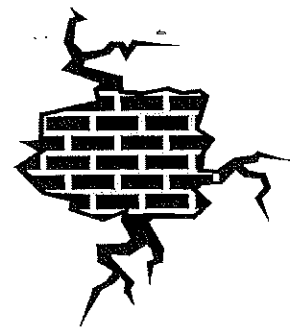

- ! How is loss of power at a station dealt with? (e.g., on-site electrical generators, alternate power source, portable electric generators)

Alarms and Monitoring

- ! How are lift stations monitored?

The answer to this question will depend on the station size, and the size and complexity of the system. In many systems, audible alarms or flashing lights are used to indicate a problem at the station. Reliance is placed on either the local populace or law enforcement to notice and report an alarm. In more modernized systems, alarm conditions are remotely monitored at a central location. This is particularly true for the larger stations. These SCADA (Supervisory Control and Data Acquisition) systems allow for real-time control, monitoring, and record keeping from remote locations.

Inspection

- ! How often are lift stations visited?
- ! What is inspected during these visits?
- ! Is there a checklist?

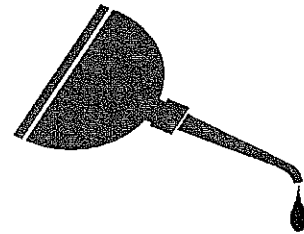

Preventative and Routine Maintenance

- ! Is there a preventive maintenance program for lift station equipment, and if so, what is involved in this program?
- ! Is an adequate parts inventory maintained for all equipment?
- ! Is there a sufficient number of trained personnel to properly maintain all stations?

Record keeping

- ! Are O&M logs maintained for all pump stations?
- ! Are manufacturer's specifications and equipment manuals available for all equipment?
- ! Are run-times or ampere readings recorded for all pumps? How is this information used to assess performance?

Force Mains and Air Release/Vacuum Valves

Force mains and air release/vacuum valves are an integral part of the transmission system. Force mains receive the lift station effluent and convey it to the gravity system or the treatment plant. Air release/vacuum valves are installed at the high points of the force main.

The route of force mains should be inspected regularly in order to determine if any leaks are present. This is particularly true where the route is through remote areas. Air release/vacuum valves should be identified and receive regular documented maintenance. Malfunctions of these valves can lead to overflows and/or a reduced hydraulic capacity of the force main.

! Does the utility schedule and conduct inspections of force main routes?

! Does the utility have a scheduled maintenance/inspection program for air release/vacuum valves?

✓ Sewer System Evaluation

As discussed in the Management section, many of the techniques in use for SSES work should be a part of a utility's operation and maintenance program. Larger utilities can justify the purchase of much of the equipment used in this effort.

Flow Monitoring

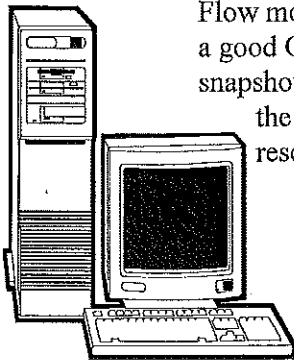

Flow monitoring data collection and evaluation should be an important part of a good O&M program. A well-designed flow monitoring program will give a snapshot of the current condition of the system. By isolating the portions of the system that are making the greatest contribution to the problem, resources can be directed where they will be of greatest benefit.

Techniques used to monitor flow include continuous metering, nighttime field measurements, quantification of pump run-times, and flow measurements taken at the treatment plant. Continuous flow measurement at key locations throughout the collection system will give the most accurate indication of system integrity. The other techniques have been used to some advantage with smaller systems.

Use of meters which measure depth of flow and velocity will allow accurate results, even under surcharged conditions. Meters are available which allow continuous data recording

which can either be downloaded locally or transmitted to a remote location. Coupled with appropriate software, this is a powerful tool for sewer system evaluation.

! Does the utility have a flow monitoring program? If so, what methods are used?

Manhole Inspection

Inspecting manholes is an important part of any maintenance program. Often utilities are unaware of the location of many of their manholes. This is unfortunate since manholes are an important source of I/I and are good indicators of problems in the system. Missing manhole lids and offset manhole cones are often the result of sewer overflows. Debris on manhole steps or high waterlines indicate the presence of surcharged conditions.

Some utilities use manhole inserts to reduce inflow to the system. A manhole insert is a small, tub-shaped plastic device installed at the top of the manhole and held in position by the manhole lid. Its purpose is to catch water that enters the manhole via holes in the lid or via the access pick holes.

! Does the utility have a routine manhole inspection program?

! Is there a data management system for documenting and tracking manhole inspection activities?

! What triggers whether a manhole needs rehabilitation?

Sewer Cleaning Related to I/I Reduction

! Are sewers cleaned prior to flow monitoring?

! Are sewers cleaned prior to televised inspection?

Televised Inspection

Inspecting sewers using closed-circuit television (CCTV) cameras is a powerful tool for I/I reduction. Leaking joints or punctures can be easily detected and often repaired at the time of inspection. CCTV is also a good method to inspect the integrity of new construction before the warranty expires.

! Does the utility use televised inspection? If so, in what context?

Smoke Testing and Dyed Water Flooding

These techniques are useful to locate defects in the system and illegal connections.

- ! Does the utility use smoke testing to identify sources of inflow into the system?
- ! Does the utility use dyed water flooding to identify suspected sources (indirect connections) of inflow into the system when smoke testing yields inconclusive results?
- ! Is there a data management system for tracking these activities?
- ! Is there a document that describes the procedures that the utility follows? Are there any standard forms?

✓ *Rehabilitation*

Several techniques are available for sewer rehabilitation. A determination of the best techniques to apply to a particular situation should be made following the SSES and an economic analysis comparing the different options.

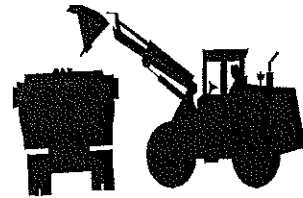

Main Line Repairs

Point and Replacement Repairs

Point repairs consist of repairing cracked, corroded, or broken gravity sewers and force mains. This work typically includes excavation to the location of the break, removal of the broken pipe section(s) and replacement with new pipe.

Joint Testing and Grouting

Joint testing and grouting are done on sewer line sections with leaking joints but no structural defects. This work can be done in conjunction with the routine televising of lines. Grouting has a limited life and must be repeated every 5-10 years.

Sewer Lining

Sewer lining is a technique which returns pipe to new condition. Many of the current systems can be used where pipe is structurally deficient. Due to the limited excavation required for these techniques, they are good choices where surface construction would cause much disruption.

- ! What type of main line repairs has the utility used in the past?
- ! Does the utility currently use any of above techniques for main line repairs?

Manhole Repairs

Manhole repairs consist of repairing structural defects or leakage in individual manholes and castings. The structural repair work may include:

- Complete manhole replacement
- Replacing castings (lid and frame)
- Replacing defective adjusting rings or top segments
- Spray relining the existing manhole
- Grouting fissures to eliminate leakage

! What rehabilitation techniques are used for manhole repairs?

! What type of documentation is kept?

✓ Service Laterals

Service laterals can often be the largest source of I/I to a system. Taps, joints, and locations of structural damage are common points where I/I may be introduced into the collection system. Most utilities have legally established what part(s) of the service lateral they maintain. Jurisdiction may cover the tap only, cover all construction to the property line, or cover construction all the way to the building. The utility itself may not have direct control over installation of new service laterals. Typically the municipality's building inspectors have this responsibility. What is important is that there is communication and a consistency of standards between the utility and building departments.

! To what degree does the utility have responsibility for service laterals?

! Does the utility have a written procedure for the approval and inspection of new construction service laterals?

! Does the utility require service laterals to meet certain standards of construction? How are these standards made available to builders?

! Does the utility have a procedure to actively find and remove illegal tap-ins?

! What is the utility's jurisdiction related to repair/replacement of service laterals?

! Does the utility include I/I originating from service laterals as part of their system evaluations?

✓ *Alternative Collection Systems*

Alternative collection systems differ significantly from the conventional gravity sewer commonly employed to convey wastewater. Alternative systems include: grinder pump pressure systems, septic tank effluent pump (STEP) systems, small diameter gravity systems, and vacuum collection systems. Each system has its own unique operation and maintenance requirements and could be found as a subset of a system which is predominately gravity sewer or by itself as a stand-alone utility.

Although each alternative system operates differently and has different maintenance requirements, all require a similar management system. In each system appurtenances are located at each residence, so the utility needs to have ready access, maintain adequate spare parts, and install alarm systems to notify the utility of any problems between inspections.

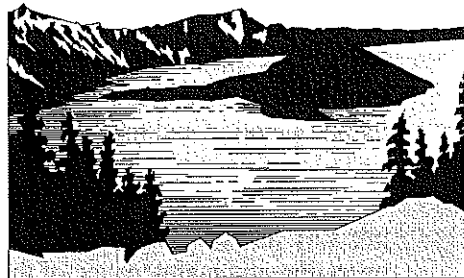

Grinder Pump Systems

Grinder systems employ a holding tank (typically up to 100 gallons and located near an individual residence) which houses a small pump with a grinder attached. Wastewater is discharged intermittently using float controls. The collection system is comprised mostly of 1½" and 2" PVC plastic lines. Manholes are generally not installed, but cleanouts should be installed at the ends of all lines and at critical points. Air release valves are installed at the downstream side of high points. Pressures are low.

A system serving 500 homes would include 500 individual pump stations so a utility needs to have an appropriate staffing level for maintenance. A minimum of two personnel should be available. Generally speaking, a staff including two full-time employees per 1,000 stations has been found sufficient for well-designed systems.

Major sources of emergency maintenance include electrical problems and grease buildup in the holding tanks, resulting in failure of the floats to activate the pumps. Corrosion within the holding tank can also be a problem. Grinding solids reduces the likelihood of solids deposition, but hydrogen sulfide may be a problem where the pressure line discharges to the treatment plant or into a gravity collection system.

Pump preventive maintenance is critical and adequate spare pumps should be in inventory. Pumps and grinders may require frequent replacement and overhaul. Pump life is limited and a plan to replace all pumps should be in place. Infiltration is generally not a problem, but exfiltration may occur through deteriorated joints.

Septic Tank Effluent Pump Systems

STEP systems are similar to the grinder pump system except a septic tank replaces the holding tank and grinders are not present on the pumps. A greater range in pump types (centrifugal, progressive cavity, etc.) are common with these systems. Although the septic tank provides preliminary treatment and solids settlement, it is part of the collection system.

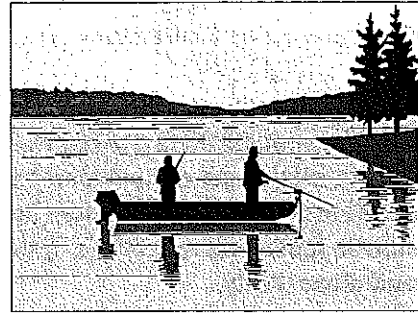

Significant infiltration may occur with poorly sealed and constructed septic tanks. Lines are generally sized assuming low infiltration rates. High infiltration rates will increase pump operation and may reduce pump life.

The wastewater is highly septic and can cause odor and corrosion problems where the pressure line discharges into a conventional manhole or treatment works. Proper operation and maintenance of the septic tank is essential for proper function of the collection system, so tanks should be pumped out on a set schedule.

Small Diameter Gravity Sewers

Like STEP systems, small diameter gravity systems use septic tanks for preliminary treatment and solids removal. However, no pumps are used. The septic tank overflows into a small diameter (4" and up) pipe placed at a moderate grade. The lower solids concentration in the wastewater results in less deposition of solids in the pipe.

Cleanouts are generally used in place of manholes, and pipes are sized assuming low infiltration rates. Similar to the STEP system, the integrity and maintenance of the septic tank is a critical factor for proper operation.

Vacuum Sewer Systems

Vacuum systems have a central vacuum station which includes vacuum pumps, holding tanks, and pressure pumps. The vacuum pumps provide a continuous suction in the collection line. A holding tank and vacuum valve are installed near each residence.

When the wastewater reaches a set level in the holding tank, the valve is opened to release a slug of liquid into the collection line. A loss of vacuum in the system will generally trigger a fault condition. Major breaks may cause the system to shut down, and leaks are difficult to locate. Once the wastewater arrives at a central vacuum station, it enters a holding tank and is pumped to the treatment facility through a force main.

- ! Does the utility have control of the near-residence portions of the collection system?
- ! Who owns the near-residence systems?
- ! Does the utility do periodic inspections of the near-residence facilities?
- ! What is the frequency of these inspections?
- ! Are pressure check valves installed on pumps?
- ! Are clean-outs installed at the end of each branch line?
- ! Is a pipe locating system installed?
- ! Are air release valves installed on the downstream side of high points?
- ! Does the system have a warning alarm system at each residence?
- ! How does the utility respond to the alarm system?
- ! Are odor control systems are installed?



**EPA Region 4
Guide to
Collection and Transmission System
Management, Operation, and Maintenance Programs**

Version 1.1



PURPOSE & DISCLAIMER

This document is the work product of the EPA Region 4, Water Protection Division, Clean Water Enforcement Branch (CWEB) and supercedes a previous draft dated September 2003 (Version 1.0). This document serves as an introduction for new Region 4 inspectors in the CWEB Municipal Infrastructure Enforcement Program and contains descriptive information for utilities conducting self-assessments in the Region 4 Management, Operation, and Maintenance (MOM) Programs Project.

The MOM Programs Project is conducted in compliance with EPA Policy, EPA Guidance, and Rules and Regulations promulgated under the Clean Water Act. If some statement or part of the document is not in compliance with the Act, EPA Policy, EPA Guidance or the Rules and Regulations, then it should not be construed as conveying rights not conveyed by the Clean Water Act, EPA Policy, or the Rules and Regulations.

October 2011

TABLE OF CONTENTS

Contents

INTRODUCTION	1
SYSTEM PROFILE AND PERFORMANCE SUMMARY	4
MANAGEMENT PROGRAMS.....	6
1. Organization.....	6
a. Organizational Chart.....	6
b. Relation to Other Municipal Functions.....	6
2. Training.....	6
a. Technical Training Program.....	6
b. Skills Training Program	6
c. Safety Training Program	7
3. Safety	7
a. Safety Authority	7
b. Confined Space Program	7
c. General Safety Procedures Program	7
d. Traffic Management Procedures Program	7
e. Lock-Out/Tag-Out Program.....	7
f. Safety Equipment Program.....	7
g. Safety Performance Program	8
4. Information Management Systems (IMS).....	8
a. Management Programs IMS.....	8
b. Operation Programs IMS	8
c. Maintenance Programs IMS.....	8
d. Customer Service IMS	8
5. Engineering.....	8
a. Collection and Transmission System Plans Program.....	8
b. System Inventory Program.....	9
c. Mapping Program.....	9
d. Sewer System Design Program.....	9
e. New Construction and Rehabilitation Inspection Program	9
f. Acquisition Considerations Program.....	9

g. Continuous Sewer System Assessment Program	9
h. Infrastructure Rehabilitation Program	11
i. System Capacity Assurance Program	11
6. Overflow Tracking.....	12
a. State Agency Reporting Program.....	12
b. Local Agency Reporting Program	12
c. Records Management Program	12
7. Financial Analyses	12
a. Cost Analysis Program.....	12
b. Capital Improvement Financing Program.....	12
c. Budget and Customer Rate Program.....	13
8. Equipment and Supplies	13
a. Spare Parts Inventory Program	13
b. Equipment and Tools Inventory Program.....	13
c. Vehicle Repair Program	13
9. Customer Service.....	13
a. Complaint Management Program	13
b. Public Information Program.....	13
c. Public Education Program.....	13
10. Legal Support.....	14
a. Inter-Jurisdictional Agreement Program	14
b. Sewer Ordinance Program	14
11. Water Quality Monitoring.....	14
a. Routine Monitoring Program	14
b. Investigative Monitoring Program.....	14
c. Impact Monitoring Program.....	14
12. Contingency Plan for Utility Infrastructure	15
a. Contingency Planning Program	15
b. Response Flow Diagram	16
OPERATION PROGRAMS	17
1. Pump Station Operation.....	17
a. Preventive Operation Program	17
b. Reactive Operation Program.....	17

2. Pretreatment Program	17
3. Corrosion Control Program.....	17
4. Fats, Oils, and Grease Control Program	17
5. Service Connection/Disconnection Program	18
6. Private Haulers Program	18
7. Line Location Program	18
MAINTENANCE PROGRAMS	19
1. Pump Station Preventive Maintenance	19
a. Pump Station Repair Program.....	19
b. Electrical Maintenance Program	19
c. Mechanical Maintenance Program.....	19
d. Physical Maintenance Program.....	19
2. Gravity Line Preventive Maintenance	19
a. Routine Hydraulic Cleaning Program	19
b. Routine Mechanical Cleaning Program	19
c. Root Control Program	20
d. Manhole Preventive Maintenance Program.....	20
3. Air Valve Preventive Maintenance Program	20
4. Maintenance of Way.....	20
a. Maintenance of Rights-of-Way and Easements Program	20
b. Street Paving Monitoring Program	20
5. Reactive Maintenance Program	20

INTRODUCTION

A utility should develop an appropriate, comprehensive Management, Operation and Maintenance (MOM) Program for the sewerage infrastructure (sewer system and wastewater treatment plant) which it owns and operates. A comprehensive MOM Program is comprised of individual management, operation, and maintenance programs, each of which:

- is specific to, and tailored for, the utility's infrastructure;
- has a written purpose explaining why the program is needed; has specific written goal(s) establishing the accomplishment(s) desired for the current fiscal year;
- has the details of the activities and procedures that are followed to implement the program written down in the form of Standard Management Procedures (SP), Standard Operating Procedures (SOP), and/or Standard Maintenance Procedures (SMP) that are used by the utility's personnel;
- is implemented by well-trained personnel; has established appropriate performance measures which are tracked by management; and,
- has a written procedure requiring periodic review, evaluation, and any necessary revision.

An important concept is that MOM programs are utility-specific. Most, if not all, of the programs described in this guide are based on actual programs observed at proactive utilities. However, utilities may have different titles for the various MOM programs described in this guide and may have them organized very differently. Some utilities may be organized in a way that they consolidate some of the MOM programs described in this guide, or they may exclude part of a program described in this guide because of justifiable circumstances. Utilities may also have additional MOM programs that are not contained in this guide.

Tailored to the Utility

The utility should have programs tailored to match its geographic, physical, and climatic conditions; level of complexity; infrastructure configuration; and level of sophistication. Utilities may also have a number of their MOM programs implemented through a managed contract rather than by their own trained personnel.

Program Purpose

The purpose of a given MOM program is the reason why the program is needed and why it exists.

Example: The purpose our utility's smoke testing program is to identify sources of inflow our sewer system that need to be eliminated so that we can regain some of our peak flow capacity.

Program Goal

The individual program goal(s) establishes the accomplishments desired for the given MOM program during the upcoming fiscal year.

Example: The goal our smoke testing program for this fiscal year is to reclaim system peak

capacity, and to reduce treatment plant hydraulic loading by identifying sources of inflow to the system by conducting investigations in the ABC and DEF sewersheds. This goal will be accomplished in a cost-effective manner using our personnel and by using a contractor.

Program Documentation

The program documentation specifies, in writing, the specific details of the activities and procedures that personnel follow to implement the program. Program documentation should be maintained in a central location and made available to all personnel.

Example: Our utility has a long-term, ongoing, smoke testing program. The program priorities and standard operating procedures are contained in a manual entitled "Smoke Testing Program for Utility X."

Implemented by Trained Personnel

Training programs are established and followed to ensure that utility personnel are well-trained to implement each program and successfully achieve each program's goals.

Example: All personnel assigned to our smoke testing activity receive three hours of basic training followed by eighty (80) hours of on-the-job training to assure competency. Our contract with outside sources to conduct smoke testing requires the contractor to follow our standard operating procedures.

Performance Measures

Appropriate performance measures should be established for each program and reviewed at minimum on an annual basis.

Example: During this fiscal year, the performance goal is to smoke test 200,000 lineal feet of gravity sewer in two sewersheds selected according to our priority procedures. Last year, we exceeded our performance goal of 178,000 lineal feet of gravity sewer by smoke testing 193,000 lineal feet. As a result, 623 defects were identified and passed on to our rehabilitation and private service lateral programs for correction.

Periodic Evaluation

An evaluation by utility management should occur for each program, annually at minimum, to evaluate how well a program accomplished the program goals established at the beginning of the period and to determine whether the program, as presently implemented, is using the most efficient approach. Remedies should be identified and scheduled to correct any deficiencies. Questions the evaluation should answer are:

- Are there program design, resource or implementation deficiencies that keep the program from achieving its performance measures?
- Are these program deficiencies leading to sanitary sewer overflows, permit violations or other

Clean Water Act violations?

- Are there program deficiencies leading to decreased customer service and/or unwarranted deterioration of utility assets?
- Are there changes that should be made to the program that will make its implementation more efficient, thereby conserving resources for better implementation of other programs?

Example: The smoke testing program has yielded good results during the past four years. Following our priority criteria, most of the significant inflow problems have been eliminated. Next year the program will be reduced by 25% and the resources applied to our maintenance of way program. Peak flows will be monitored at key locations to determine if this reduction in the smoke testing program will need to be reversed in the future. Additionally, we are conducting a cost analysis to determine whether we should contract out for all smoke testing work in the future.

SYSTEM PROFILE AND PERFORMANCE SUMMARY

A proactive utility will maintain a profile of its system as a basis for explaining its situation to regulatory agencies, the public, and when networking with other utilities. A profile typically contains basic population and inventory information as well as a recent system performance summary. An example of a system performance summary is provided on the following page.

Population Served:

Number of Customers:

Number of Treatment Plants:

Total Wastewater Design Treatment Capacity:

Total Volume of Wastewater Treated:

Miles of Gravity Sewers:

Number of Manholes:

Number of Inverted Siphons:

Number of Pump Stations:

Miles of Force Main:

Number of Employees:

Annual Capital Improvement Budget:

Annual Operation and Maintenance Budget: ...

Total Annual Operating Budget:

System-Wide MOM Programs Recent Performance Summary												
Performance Measures for Previous 12 Months	Year	Month										
A. Number of Customer Complaints												
B. Number of NPDES Permit Violations												
C. Number of Capacity-Related Overflows												
D. Number of Maintenance-Related Overflows												
E. Number of Operations-Related Overflows												
F. Number of Blockages												
G. Number of Cave-Ins												
H. Number of Pump Station Failures												
I. Peak Flow Factor at Treatment Plant (1 hour high/dry month avg.)												
J. Monthly Average Treatment Plant Flow Rate (gal/capita/day)												
K. Monthly High One Day Treatment Flow Rate (gal/capita/day)												
L. Number of By-Passes at Treatment Plant												
M. Volume of Treatment Plant By-Passes (gal)												
N. WWTP Weekly Average Influent BOD (mg/L)												

MANAGEMENT PROGRAMS

1. Organization

a. Organizational Chart

An organizational chart clearly depicts all units in the organization, the lines of authority between the various organization units, a description of the functions of each of the organization units, the title and duties of each position in the organization units and an indication of whether or not each position is currently budgeted and filled.

b. Relation to Other Municipal Functions

An organizational chart clearly depicts the relationship of the sewerage utility to other municipal functions such as public works, streets and drainage, building inspection, building permits, and public health. There is a mechanism for updating the chart in manner timely to changes which may occur in the organization.

2. Training

a. Technical Training Program

This program specifies requirements (curriculum) for initial and refresher training to ensure each employee has a level of knowledge, commensurate with duties, of the overall functions of the utility's infrastructure. This program also includes outside technical training and networking opportunities, such as conferences and seminars, that are made available to employees.

The program includes the extent to which employee certification, at either the State or the utility's organization level, is required as a basis for obtaining or maintaining a position. Records of technical training are maintained and the degree to which completed technical training is tied to promotion and pay is specified. Finally, the program specifies the technical training required before an employee is permitted to undertake specific work assignments or tasks.

b. Skills Training Program

This program specifies requirements (curriculum) for initial and refresher training to ensure each employee has a level of knowledge, commensurate with duties, of the specific equipment to be used and the procedures to be followed in carrying out duties. This program should include outside skills training opportunities, such as manufacturers' or vendors' training workshops, that are made available to employees.

The program includes the extent to which employee certification, at either the State or the utility's organization level, is required as a basis for obtaining or maintaining a position. Records of skills training, whether formal or on-the-job apprenticeship, are maintained and the degree to which completed training is tied to promotion and pay is specified. Finally, the program specifies the skills and on-the-job training required before an employee is permitted to undertake specific work assignments or tasks.

c. Safety Training Program

This program specifies requirements (curriculum) for initial and refresher training to ensure each employee has an adequate level of knowledge regarding on-the-job safety. The program includes the extent to which employee safety certification at the State or at the utility's organization level is required as a basis for obtaining or maintaining a position. Records of safety training, including on-the-job safety meetings, are maintained. Finally, the program specifies the safety training required before an employee is permitted to undertake specific work assignments or tasks.

3. Safety

a. Safety Authority

A Safety Authority (whether a safety department, safety committee, safety officer, or similar mechanism) is present to establish utility safety policy, oversee compliance, and maintain the overall Safety Program. Program maintenance includes specifying safety resources needed for utility activities, assuring record of appropriate standard reporting forms, and establishing a Safety Review Board if appropriate.

b. Confined Space Program

This program provides marking for confined spaces, and uses a permitting system and written standard procedures for confined space entry.

c. General Safety Procedures Program

This program provides instruction in defensive driving, first aid, CPR, personal sanitation, personal protection clothing, and similar general work-related safety issues.

d. Traffic Management Procedures Program

This program provides for standard traffic management techniques, off-hour scheduling of line work, and coordination with law enforcement.

e. Lock-Out/Tag-Out Program

This program provides signs on equipment involved in the program, limitation to authorized personnel, required tag information, and permit requirements.

f. Safety Equipment Program

This program assures the availability of appropriate safety equipment such as tripods and hoists, well-calibrated atmospheric testing equipment, self-contained breathing apparatuses, lights and barricades, exhaust fans, and personal protective clothing.

g. Safety Performance Program

This program tracks parameters such as number of injuries, lost days, and workman's compensation claims to be used by management to assess Safety Program effectiveness.

4. Information Management Systems (IMS)

a. Management Programs IMS

This information management system enables utility management to adequately evaluate operation, maintenance, customer service (complaint response), and system rehabilitation activities so that overall system performance can be determined and utility planning can be conducted.

b. Operation Programs IMS

This information management system is used to track scheduled operational activities and to enhance operational performance. The system ensures timely production of operating reports and standardized data collection methods are used by field personnel (e.g., forms or PDA files). The system requires data review by the field supervisor and securely preserves operating records. While the system need not be computer-based, it should be capable of feeding information to the Management Programs IMS.

c. Maintenance Programs IMS

This information management system is used to track scheduled maintenance activities and to enhance maintenance performance. The system ensures timely production of maintenance reports and standardized data collection methods are used by field personnel (e.g., forms or PDA files). The system requires data review by the field supervisor and securely preserves maintenance records. While the system need not be computer-based, it should be capable of feeding information to the Management Programs IMS.

d. Customer Service IMS

This information management system is used to track reactive activities (i.e., emergencies or customer complaints) and to enhance customer service. The system ensures timely production of complaint reports and standardized data collection methods are used by field personnel (e.g., work order forms or PDA files). The system requires data review by the field supervisor and securely preserves service records. While the system need not be computer-based, it should be capable of feeding information into the Management Programs IMS.

5. Engineering

a. Collection and Transmission System Plans Program

This program ensures a full set of as-built plans for the collection and transmission system are available, field crews have ready access to the plans, and a written standard procedure is present to account changes, update the plans, and supply revised versions to field crews in a timely manner.

b. System Inventory Program

This program ensures an inventory of the utility's collection and transmission system is present, updated, and cataloged by service area or sewershed. The inventory lists the system components with their attributes and characteristics (e.g., pipe age, pipe size, pipe material, invert elevation, pump sizes, location of inverted siphons, pump stations, manholes, etc.).

c. Mapping Program

This program ensures adequately detailed maps are available to be used in conjunction with the utility's MOM programs. At minimum, the maps depict the location of gravity sewer lines, force mains, air valves, manholes (by identifying numbers), pump stations, major appurtenances, and the size of pipes.

d. Sewer System Design Program

This program ensures all new sewer system construction will be adequately designed and constructed using specifications that assure the integrity of the infrastructure. The program includes documented design criteria (e.g., slope and bedding materials), use of standardized construction details, use of standardized materials and construction practices, a standard design review process which includes review by utility personnel for possible maintenance concerns, standardized review forms, and record keeping procedures.

e. New Construction and Rehabilitation Inspection Program

This program ensures new construction or rehabilitative work is properly inspected, and built using the utility's standard construction specifications (including use of best management practices to prevent stream pollution). The program includes use of standardized construction procedures, standardized construction testing procedures, standardized inspection and testing forms/reports, and assurance that the inspection is conducted under the authority and supervision of a registered Professional Engineer. The program also provides subsequent closed circuit television (CCTV) inspection of line construction prior to expiration of the warranty, and retention of the tapes for reference.

f. Acquisition Considerations Program

This program ensures prospective infrastructure is inspected and evaluated for compliance with the utility's standard design and construction criteria before it is acquired by the utility from another entity. The program includes written standard procedures to conduct the evaluation and estimate the time/cost requirements to bring the infrastructure into compliance with utility standards.

g. Continuous Sewer System Assessment Program

i.) Prioritization

This program prioritizes sewer service areas (i.e., sewersheds) for sewer system assessment activities. Prioritization is based upon information such as complaints, flow monitoring (including flow isolation studies), historical location of sewer overflows, pump station run times, field crew work orders, and other relevant information available to the utility.

ii.) Dyed Water Flooding

This program conducts dyed water testing, when appropriate, to locate sources of inflow and other illicit connections to the sewer system. The program includes written standard procedures, standard forms, performance measures, and a mechanism for including dyed water testing information in the IMS.

iii.) Corrosion Defect Identification

This program identifies locations within the sewer infrastructure subject to corrosion and provides for inspection of those locations for corrosion on a routine basis. The program includes written procedures for corrosion identification, corrosion identification forms, performance goals, corrosion defect analysis, and a mechanism for including corrosion defect information in the IMS.

iv.) Manhole Inspection

This program ensures routine inspection of manholes within the sewer system. The program includes standard manhole inspection procedures, manhole inspection forms, performance goals, manhole defect analysis, and a mechanism for including manhole inspection information in the IMS.

v.) Flow Monitoring

This program supplies flow monitoring data to support engineering analyses related to sewer system capacity and peak flow evaluations, and to assist scheduling of sewer line maintenance. The program may include installation of an appropriate number of calibrated permanent and/or temporary flow meters, or rudimentary use of visual flow observations taken during base flow periods in wet and dry seasons. The latter option is more cost-effective for some very small utilities. Either program should include a procedure for adequate rainfall measurement, servicing meters, and a mechanism for including flow monitoring information in the IMS.

vi.) Closed Circuit Television (CCTV)

This program provides internal inspection of the integrity of gravity sewer lines. The appropriate number of qualified CCTV personnel and dedicated equipment, or the scope of a CCTV contract, is determined to ensure sewer inspection work is completed properly. The program includes standard operating procedures (including pre-inspection cleaning), performance measures, and mechanisms for including CCTV information in the IMS and retaining CCTV tapes.

vii.) Gravity System Defect Analysis

This program analyzes gravity sewer system defects. The program includes standard defect codes, written defect identification procedures and guidelines, a standardized process for cataloging gravity system defects, a mechanism for including gravity system defect information in the IMS, and training specified for personnel.

viii.) Smoke Testing

This program identifies sources of inflow into the gravity sewer system by use of smoke

testing equipment. The program includes written standard smoke testing procedures, smoke testing forms, performance goals, smoke testing defect analysis, and a mechanism for including smoke testing information in the IMS.

ix.) Service Lateral Investigations

This program investigates infiltration and inflow contributions and other problems originating in service laterals. The program includes written standard investigation techniques, standard investigation forms, performance goals, standard analysis procedures, and a mechanism for including service lateral investigation information in the IMS.

x.) Pump Station Performance and Adequacy

This program permits evaluation of pump station performance and pump station adequacy. The program includes trend analysis of pump run-time meter, pump start-counter, or amperage data; historical review of the fundamental causes of pump failures; use of appropriate remote monitoring and alarm notification equipment; and a mechanism for including pump station performance information in the IMS.

h. Infrastructure Rehabilitation Program

This program rehabilitates gravity sewer lines, force mains, manholes, pump stations, and related appurtenances. The program includes a process for prioritizing rehabilitation, inventory of all completed rehabilitation (including a breakdown of the rehabilitation techniques used), inspection and performance measurement for all completed rehabilitation, written schedules for rehabilitation work, and a mechanism for including rehabilitation information in the IMS.

i. System Capacity Assurance Program

i.) Capacity Assurance for New Connections

This program ensures there is adequate capacity to collect, transmit, and treat additional sewage expected as a result of prospective new sewer connections. The program is integrated into, or thoroughly coordinated with, the building permit process. It is also integrated into the Acquisition Considerations Program described above in 5(f). The program has a mechanism for including capacity assurance information in the IMS.

ii.) Protocols for Capacity Assurance

The program includes, but is not limited to: use of standardized design flow rate rules of thumb (i.e., regarding pipe roughness, manhole head losses, accuracy of distance and slope on as-built drawings, and water use); use of techniques to predict the impacts of additional flow (i.e., use of a hydraulic model of gravity system, pressure system, and other appropriate techniques); and use of flow metering to confirm mathematical estimations of existing peak flow. The program requires certification of adequate capacity by a registered Professional Engineer, and includes an IMS mechanism for integrating analysis from this program with information on infiltration/inflow reduction activities.

6. Overflow Tracking

a. State Agency Reporting Program

This program includes written standard operating procedures which clearly define the minimum State Agency reporting requirements for events where sewage leaves the infrastructure before treatment, and the steps utility personnel must follow to meet or exceed those reporting requirements.

b. Local Agency Reporting Program

This program provides secondary notice to the public and to other appropriate organizations (e.g., downstream utilities with water intakes and local public health authorities) when an overflow presents an imminent and substantial threat to public health or the environment. The program includes written criteria for making this notice, procedures for notifying news media and posting notices at stream locations, and may also prepare an annual summary report available to the public.

c. Records Management Program

This program tracks all events where sewage leaves the utility's collection or transmission system before treatment (i.e., overflows to land, directly to waters, or indirectly to waters by storm drains or other paths). The program uses standardized forms which record, at minimum, the following information for response and inclusion in the IMS:

- ❖ Location of the discharge
- ❖ Name of the receiving water and description of the pathway (e.g., storm drain)
- ❖ Estimation of the discharge volume and the method of estimation
- ❖ Description of the system component that is source of the discharge
- ❖ Date and time the discharge started and stopped
- ❖ Root cause, or suspected root cause, of the discharge
- ❖ Steps taken to eliminate the discharge and steps taken to prevent reoccurrence.

7. Financial Analyses

a. Cost Analysis Program

This program regularly analyzes and projects future utility management, operations, and maintenance costs needed to properly implement these utility programs. The cost analyses include, at a minimum: overhead, labor and equipment, financial impacts of outsourcing certain activities, overtime, and the financial impacts imposed by organizational departments or agencies outside the utility. Cost analyses are performed for all management, operations, and maintenance equipment and the capital infrastructure investment. Cost analyses incorporate life cycle depreciation and establish cost-effective points for replacement. The program has a mechanism for including such replacement points in the IMS.

b. Capital Improvement Financing Program

This program analyzes, projects, plans and finances capital improvement needs established through proper engineering study. Capital improvement financing is planned using a five (5) year planning horizon with annual updates.

c. Budget and Customer Rate Program

This program establishes the annual utility budget and recommends customer rates. The program assures that the budget and funding provided by customer rates will meet the cost and capital financing needs set by programs 7(a) and 7(b) above.

8. Equipment and Supplies

a. Spare Parts Inventory Program

This program ensures proper management of the utility spare parts inventory including spare pipe. The program includes adequate parts storage facilities, identification and retention of an adequate number of critical spare parts (i.e., those which are difficult to obtain quickly but critical to proper operations), control of access to spare parts, an organized system for inventory management (either manual or computerized), arrangement with local vendors for common parts, and specification of spare parts to be carried on vehicles.

b. Equipment and Tools Inventory Program

This program ensures proper management of the utility equipment and tools inventory. The program includes adequate equipment and tools storage facilities, control of access to equipment and tools, an organized system for inventory management (either manual or computerized), and specification of equipment and tools to be carried on vehicles.

c. Vehicle Repair Program

This program ensures proper management of utility vehicles. The program includes provisions for vehicle maintenance and vehicle repair. Performance measures for the program will consider turn-around time, cost factors, contract maintenance, and the life cycle cost analysis performed for vehicles.

9. Customer Service

a. Complaint Management Program

This program ensures proper complaint management. The program includes written standard management procedures for dispatchers (i.e., dispatch priorities, work order generation, and standardized complaint and problem codes). The program uses an organized record keeping procedure (including the use of standardized forms) which facilitates tracking work orders and follow-up with customers, and uses a mechanism to evaluate response performance and supply this information to the IMS.

b. Public Information Program

This program communicates utility activities which may closely impact the public (e.g., smoke testing, major construction or maintenance, or emergency maintenance), and ensures communication of activities which may coincide with those of other departments and agencies (e.g., street paving).

c. Public Education Program

This program educates the public and solicits support regarding issues such as service lateral maintenance, grease management, food disposals, inflow sources,

maintenance/rehabilitation needs requiring increased rates, and problems caused by basement sump pumps.

10. Legal Support

a. Inter-Jurisdictional Agreement Program

This program develops, negotiates, and enforces agreements with neighboring utilities which send the utility flow or with major volume sewer customers. The program ensures that the agreements require the second party to have proper management, operation, and maintenance programs so the utility's infrastructure is not stressed by problems originating across jurisdictional boundaries. The program also ensures the agreements address flow-based capacity issues, specify the life of the agreement, have credible provisions for enforcement, and have provisions for modification.

b. Sewer Ordinance Program

This program develops, revises, and amends sewer ordinances as needed to support the proper management, operation, and maintenance of the utility. The program provides adequate legal authority for the utility regarding sewer use, grease management, pretreatment, private service laterals, sump pumps and roof drains, private haulers, recovering costs of damage to utility infrastructure, and other legal authorities as required. Legal support is provided for case work and guidance for utility staff.

11. Water Quality Monitoring

a. Routine Monitoring Program

This program determines the existence of unpermitted discharges originating at locations where sewers cross waterways or at other isolated or remote sewer locations. The program includes scheduled sampling during dry weather periods from a network of monitoring stations. The program also includes a map of the sampling network, and formally establishes sampling frequency, sampling parameters (i.e., fecal coliform and others), standard sampling procedures, quality assurance/quality control procedures, and a mechanism for including program information in the IMS.

b. Investigative Monitoring Program

This program determines the source of industrial, commercial, or sanitary wastewater resulting from cross connections with the stormwater drainage system, and typically activates through complaints or discovery by operations personnel. The program has formally established sampling parameters (i.e., fecal coliform and others), standard sampling procedures, quality assurance/quality control procedures, and a mechanism for including program information in the IMS.

c. Impact Monitoring Program

This program determines the impact of pollution resulting from discharges occurring within the utility infrastructure before treatment. Combined with the reporting programs described in Overflow Tracking (6) above, this program assists the utility, regulatory authorities, and public health authorities determine the appropriate response to protect health and/or the environment. The program has formally established sampling parameters (i.e., fecal coliform

and others), standard sampling procedures, quality assurance/quality control procedures, and a mechanism for including program information in the IMS.

12. Contingency Plan for Utility Infrastructure

a. Contingency Planning Program

This program develops and modifies contingency plans for the sewer system and the treatment facilities that will be implemented during emergency situations. The planning process includes a preparedness committee of senior and experienced management and field personnel. A system overview is conducted to determine vulnerability to a variety of events which may be due to utility failures, natural causes, or failures caused by another party. Based upon these hypothetical events and past experience taken from root cause failure information in the IMS, prediction system component failure is made. Strategies to timely repair or overcome such component failures are developed, and the six (6) major contingency plan components are available in writing: public notification, agency notification, emergency flow control, emergency operation and maintenance, preparedness training, and water quality monitoring (described in 11(c) above).

i.) Public Notification

The public notification component includes a set of criteria, developed with input from local public health authorities, which are used as a basis for initiating public notification; a step-by-step procedural flow diagram; a list of manager names and phone numbers; a plan for regular business hours, off-hours, weekends, and holidays; a list of *Public Contacts* with phone numbers; identification of managers authorized to give statements; and pre-scripted news releases.

ii.) Agency Notification

The agency notification component includes a set of criteria, developed with input from appropriate local, State, and Federal authorities, which are used as a basis for initiating agency notification; a step-by-step procedural flow diagram; a list of manager names and phone numbers; a plan for regular business hours, off hours, weekends, and holidays; a list of *Agency Contacts* with phone numbers; identification of personnel authorized to contact agencies; and copies of standard reporting forms used by the agencies.

iii.) Emergency Flow Control

The emergency flow control component is used to reduce overflow volumes and pollution where possible. The component includes a set of criteria which are used as a basis for initiating emergency flow control procedures; a step-by-step procedural flow diagram; a list of manager names and phone numbers; a plan for regular business hours, off-hours, weekends, and holidays; a list of *Emergency Flow Control Contacts* with phone numbers; identification of personnel authorized to initiate the emergency flow control program; and standard emergency flow control reporting forms.

Flow control activities may include flow re-routing, flow diversion, household flow reduction and advisories, commercial flow reduction and advisories, water pressure reduction and advisories, or use of pretreatment program protocols set forth in permits for

significant industrial users. The initiating criteria, reporting forms and report formats should be developed in cooperation with significant industrial users and appropriate local, State, and Federal authorities.

iv.) Emergency Operation and Maintenance

The emergency operation and maintenance component includes a set of criteria which are used as a basis for initiating emergency operation and maintenance procedures; a step-by-step procedural flow diagram; a list of manager names and phone numbers; a plan for regular business hours, off-hours, weekends, and holidays; a list of *Emergency Operation and Maintenance Contacts* with phone numbers; identification of personnel authorized to initiate emergency operation and maintenance procedures; and standard reporting forms.

The initiating criteria, reporting forms, and report formats should be developed in cooperation with utility's insurance representatives, State and Federal emergency management agencies, and the State regulatory authority. Further, development of the emergency operations and maintenance component should include analyses of the need and use of stand-by equipment (prearranged rentals), stand-by contractors, and access to critical spare parts.

v.) Preparedness Training

The preparedness training component ensures that all personnel are fully aware of procedures and able to efficiently implement the Contingency Plan. The preparedness training component includes specialized training courses, field trials, and special emergency situation safety training.

b. Response Flow Diagram

This diagram includes the roles of senior management and field personnel and shows the relationship of the six (6) major contingency plan components: public notification, agency notification, emergency flow control, emergency operation and maintenance, preparedness training, and water quality monitoring.

OPERATION PROGRAMS

1. Pump Station Operation

a. Preventive Operation Program

This program ensures reliable operation of the transmission system through use written standard operating procedures available for both manned and unmanned stations. Procedures may include reading and recording information from pump run-time meters, or start counters, or taking amperage readings; recording wet well conditions and grease accumulation; checking and resetting (as necessary) wet-well set points; checking and recording system pressure; checking remote monitoring and alarm equipment components; checking operation of alarms and stand-by power; and reporting maintenance needs. The program has established schedules, routes, priorities, standard forms, performance measures, and a mechanism for including program information in the IMS.

b. Reactive Operation Program

This program ensures timely response to atypical situations in the transmission system through use of written standard operating procedures available for both manned and unmanned stations. Procedures may include initiating auxiliary power with portable generators, installing portable pumps during high flow, or initiating the Contingency Plan. The program has established standard forms and reporting procedures, performance measures, and a mechanism for including program information in the IMS.

2. Pretreatment Program

This program ensures that operation of the utility's treatment facility is protected from pollutant pass-through or interference. If a utility has industrial or commercial users it may have this program which includes industrial user identification, permitting, monitoring and inspections, enforcement, and other components. Personnel involved with the utility pretreatment program will have frequent communication with operation and maintenance personnel to detect possible pretreatment permit violations. The program has standard operating procedures, performance measures, inspection schedules, and a mechanism for including program information in the IMS.

3. Corrosion Control Program

This program provides for inspection of the utility infrastructure for corrosion caused by hydrogen sulfide or other corrosives, the development and implementation of site-specific corrosion control measures, a monitoring program to evaluate corrosion control measures, program performance measures, and a mechanism for including program information in the IMS.

4. Fats, Oils, and Grease Control Program

This program prevents fats, oils, and grease from entering the utility infrastructure, therefore preserving sewer capacity, prolonging the infrastructure life, reducing overflow events, and saving the utility maintenance costs. The program includes a grease control ordinance, grease trap and interceptor design standards, permitting and inspecting commercial grease traps and interceptors, a credible enforcement component, a public education component for residential sources, performance measures, and a mechanism for including program information in the IMS.

5. Service Connection/Disconnection Program

This program includes written standard procedures for new sewer tap installation or for sewer disconnection; inspection of all new service connections to, or disconnections from, the utility sewer; a credible enforcement program; performance measures; and a mechanism for notifying personnel in the Mapping Program or including program information in the IMS.

6. Private Haulers Program

This program issues permits to private commercial or septic tank waste haulers discharging to the utility, and includes written standard operating procedures for inspection/sampling of the haulers, a credible enforcement program, program performance measures, and a mechanism for including program information in the IMS.

7. Line Location Program

This program responds to requests for utility sewer line locates, and includes written standard line location procedures, defined prioritization to assist scheduling, appropriate staffing and equipment for the average number of requests, standard line location procedures, standard forms, performance measures, and a mechanism for including program information in the IMS.

MAINTENANCE PROGRAMS

1. Pump Station Preventive Maintenance

a. Pump Station Repair Program

This program is a reactive maintenance component intended to repair pump stations that are currently in a state of disrepair but still cost-effective to service. The program includes established priorities for pump station repairs, maintaining an ongoing inventory of completed repairs, a work schedule for pump station repairs, and a mechanism for including pump station repair information in the IMS. Upon completion of pump station repairs, service activities are transferred to the pump station Preventive maintenance program.

b. Electrical Maintenance Program

This program is a component of the pump station Preventive maintenance program. The program includes an established number of crews and personnel required to perform effective electrical maintenance, written standard electrical maintenance procedures, scheduling Preventive maintenance, standard forms, performance measures, and a mechanism for including electrical maintenance information in the IMS.

c. Mechanical Maintenance Program

This program is a component of the pump station Preventive maintenance program. The program includes an established number of crews and personnel required to perform effective mechanical maintenance, written standard mechanical maintenance procedures, scheduling Preventive maintenance, standard forms, performance measures, and a mechanism for including mechanical maintenance information in the IMS.

d. Physical Maintenance Program

This program is a component of the pump station Preventive maintenance program. The program includes an established number of crews and personnel required to perform effective physical maintenance, written standard physical maintenance procedures, scheduling, standard forms, performance measures, and a mechanism for including physical maintenance information in the IMS.

2. Gravity Line Preventive Maintenance

a. Routine Hydraulic Cleaning Program

This program includes accurately determined cleaning needs, established priorities and scheduled cleaning activities, support of an appropriate number of crews and personnel, acquired necessary equipment (e.g., Jet Unit, Combination Unit, etc.), written standard hydraulic cleaning procedures, standard forms, performance measures, and a mechanism for including hydraulic cleaning information in the IMS.

b. Routine Mechanical Cleaning Program

This program includes accurately determined cleaning needs, established priorities and scheduled cleaning activities, support of an appropriate number of crews and personnel, acquired necessary equipment (e.g., Rodders, Bucket Machine, etc.), written standard mechanical cleaning procedures, standard forms, performance measures, and a mechanism

for including mechanical cleaning information in the IMS.

c. Root Control Program

This program includes accurately determined root control needs, established priorities and scheduled activities, support of an appropriate number of crews and personnel, acquired necessary equipment (e.g., mechanical, chemical, etc.), written standard root control procedures, standard forms, performance measures, and a mechanism for including root control information in the IMS.

d. Manhole Preventive Maintenance Program

This program includes accurately determined manhole maintenance needs, established priorities and scheduled activities, support of an appropriate number of crews and personnel, acquired necessary equipment (rings and lids, structural repair, etc.), written standard manhole maintenance procedures, standard forms, performance measures, and a mechanism for including manhole maintenance information in the IMS.

3. Air Valve Preventive Maintenance Program

This program provides for inspection and maintenance of air valves located on force mains (including regular valve exercise). The program includes an established number of crews and personnel required to perform effective Preventive maintenance, written standard air valve maintenance procedures, scheduling, standard forms, performance measures, and a mechanism for including air release valve maintenance information in the IMS.

4. Maintenance of Way

a. Maintenance of Rights-of-Way and Easements Program

This program includes accurately determined maintenance needs, established priorities and scheduled activities, support of an appropriate number of crews and personnel (based on the number of waterway crossings and/or miles of sewer off-street), written standard maintenance procedures, standard forms, performance measures, and a mechanism for including maintenance information in the IMS.

b. Street Paving Monitoring Program

This program includes accurately determined monitoring needs, established priorities and scheduled activities, coordination with storm drain projects and street and highway officials, support of an appropriate number of crews and personnel, acquired necessary equipment (e.g., manhole and valve raising, etc.), written standard monitoring procedures, standard forms, performance measures, and a mechanism for including monitoring information in the IMS.

5. Reactive Maintenance Program

This program provides response to customer complaints or other unscheduled system problems forwarded by dispatchers. The program includes support of an appropriate number of crews and personnel, written standard response procedures including a protocol for initiating the Contingency Plan, standard forms, collection of information in support of failure analysis, sewer map availability, performance measures, and a mechanism for including reactive maintenance information in the IMS.

Useful References for Management, Operations, and Maintenance Programs

The following references may be obtained from their cited sources. Documents referenced to California State University, Sacramento may be obtained by contacting:

California State University, Sacramento
Office of Water Programs
6000 J Street
Sacramento, California 95819-6025
(Tel) 1-916-278-6142 (Fax) 1-916-278-5959
(E-mail) wateroffice@csus.edu

Documents referenced to the Water Environment Federation may be obtained by contacting:

Water Environment Federation
601 Wythe Street
Alexandria, VA 22314-1994 USA
(Member Services Center) 1-800-666-0206
(Fax) 1-703-684-2492 (E-mail) pubs@wef.org
(Internet) <http://www.wef.org/TechResCatalog/marketplace/>

Documents referenced to the Environmental Protection Agency may be obtained by contacting either the NCEP (if in stock) or the NTIS:

U.S. Environmental Protection Agency
National Service Center for Environmental Publications
P.O. Box 42419
Cincinnati, OH 45242
(Tel) 1-800-490-9198 (Fax) 1-513-489-8695
(Internet) <http://www.epa.gov/ncepihom/orderpub.html>

National Technical Information Service
5285 Port Royal Road
Springfield, VA 22161
(Tel) 1-800-553-NTIS (Fax Orders) 1-703-605-6900
(E-mail) orders@ntis.fedworld.gov
(Internet) <http://www.ntis.gov/ordering.htm>

The EPA Region 4 Guide may be obtained by contacting Region 4 directly:

U.S. Environmental Protection Agency, Region 4
Water Management Division
Water Programs Enforcement Branch
61 Forsyth Street, SW
Atlanta, GA 30303-8909

Useful References for Management, Operations, and Maintenance Programs

- Sewer System Infrastructure Analysis and Rehabilitation, October 1991, United States Environmental Protection Agency, EPA/625/6-91/030
 - Collection Systems: Methods for Evaluating and Improving Performance, 1998, California State University, Sacramento Foundation, Rick Arbour and Ken Kerri, USEPA Grant No. CX924908-01-0
 - Wastewater Collection Systems Management, Manual of Practice 7, 1998, Water Environment Federation, 601 Wythe Street, Alexandria, Virginia, 22314
 - Operation and Maintenance of Wastewater Collection Systems, A Field Study Program, Fifth Edition, Volume 1, 1996, California State University, Sacramento
 - Operation and Maintenance of Wastewater Collection Systems, A Field Study Program, Fifth Edition, Volume 2, 1996, California State University, Sacramento
 - NPDES Compliance Inspection Manual, Chapters 4 and 9, September 1994, EPA 300-B-94-014
 - Handbook for Retrofitting POTWs, July 1989, EPA 625-689-020
 - Pretreatment Compliance Monitoring and Enforcement Guidance, September 1986, United States Environmental Protection Agency
 - Guidance for Conducting a Pretreatment Compliance Inspection, September 1991, EPA 300R-92-009
 - EPA Region 4 Guide for Conducting Evaluations of Municipal Wastewater Collection System Management, Operation, and Maintenance Programs, October 30, 1996
- = Available for viewing on-line at the National Environmental Publications Internet Site (NEPIS). Go to www.epa.gov/ncnepihom/nepishom and search using the document code (e.g., 625689020).

System-Wide MOM Programs Recent Performance Summary											
Performance Measures for Previous 12 Months	Year										
	Month										
A. Number of Customer Complaints											
B. Number of NPDES Permit Violations											
C. Number of Capacity-Related Overflows											
D. Number of Maintenance-Related Overflows											
E. Number of Operations-Related Overflows											
F. Number of Blockages											
G. Number of Cave-Ins											
H. Number of Pump Station Failures											
I. Peak Flow Factor at Treatment Plant (1 hour high/dry month avg.)											
J. Monthly Average Treatment Plant Flow Rate (gal/capita/day)											
K. Monthly High One Day Treatment Flow Rate (gal/capita/day)											
L. Number of By-Passes at Treatment Plant											
M. Volume of Treatment Plant By-Passes (gal)											
N. WWTP Weekly Average Influent BOD (mg/L)											

SYSTEM PROFILE AND PERFORMANCE SUMMARY

A proactive utility will maintain a profile of its system as a basis for explaining its situation to regulatory agencies, the public, and when networking with other utilities. A profile typically contains basic population and inventory information as well as a recent system performance summary. An example of a system performance summary is provided on the following page.

- Population Served:** _____
- Number of Customers:** _____
- Number of Treatment Plants:** _____
- Total Wastewater Design Treatment Capacity:** _____
- Total Volume of Wastewater Treated:**
- Miles of Gravity Sewers:** _____
- Number of Manholes:** _____
- Number of Inverted Siphons:** _____
- Number of Pump Stations:** _____
- Miles of Force Main:** _____
- Number of Employees:** _____
- Annual Capital Improvement Budget:**
- Annual Operation and Maintenance Budget:** ... _____
- Total Annual Operating Budget:**

EFFICIENCY MADE EASY

Promotes water efficient products and practices, saving H2O and electricity. Partners receive recognition and use of EPA logo.

~ *Success story: Georgia's Cobb County replaced 1682 toilets with low flow saving 9.5 million gal/yr.*

www.epa.gov/watersense

Artie Buff, 404-562-9336

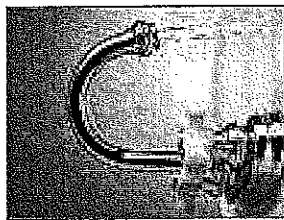

Water conservation in action.

NATIONAL PARTNERSHIP FOR ENVIRONMENTAL PRIORITIES (NPEP)

Partnership with EPA that reduces the use of any of the 31 Priority Chemicals (e.g. Lead, Polycyclic Aromatic Hydrocarbons (PAHs)).

~ *Success stories: Wire-rope Works eliminated 27,000 lbs. Lead, Saving \$50,000/yr.*

www.epa.gov/epaoswer/hazwaste/minimize/partnership.htm

Dave Langston, 404-562-8478



PERFORMANCE TRACK

Go above and beyond legal requirements. Benefits: Reduced Reporting under Maximum Achievable Control Technology (MACT), Extended Accumulation for RCRA Waste, and more.

~ *Success story: Rohm and Haas Electronic Materials replaced burner control sections with high-efficiency motor controllers. Saving \$49,000/yr. and reducing energy use by 3.7 billion BTU/yr.*

www.epa.gov/performance-track

Reggie Barrino, 404-562-9635

ENERGY STAR

Save money through energy efficient products and practices. Covers 50 product categories. In 2007, program saved consumers \$16 billion in energy costs.

~ *Success story: Marriott instituted various energy saving techniques saving \$6 million; 3M increases energy efficiency 9%, saves \$10 million.*

www.energystar.gov

Danny Orlando, 404-562-9087

WASTE REDUCTION RESOURCE CENTER (WRRC)

Pollution Prevention (P2) Info clearinghouse—Online technical P2 library/case studies, training courses, Topic Hubs, P2 News, State P2 Contract Information.

<http://wrcc.p2pays.org>

1-800-476-8686



WASTE WISE

Information geared towards municipal solid waste and select industrial wastes (e.g. packaging, paper, wood pallets, batteries) Free technical assistance, case studies, and public recognition/awards.

~ *Success story: Pepsi switched from corrugated to reusable shipping, saving \$44 million.*

www.epa.gov/wastewise

Rhonda Rollins, 404-562-8664

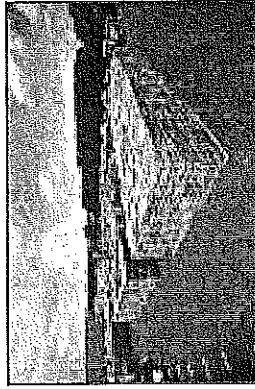

Wooden pallets being prepared for reuse.

RESOURCE CONSERVATION CHALLENGE (RCC)

Save money and energy - Manage materials more efficiently through recycling and reuse.

www.epa.gov/rcc

www.epa.gov/region4/recycle

~ *Success story: Rooms To Go's comprehensive recycling program grossed over \$1 million in 2007.*

Dee Rodgers-Smith (Solid Waste), 404-562-8688

Mary Beth Van Pelt (Organics), 404-562-8615

Kim Clifton (E-Waste), 404-562-8477

Steve Smith (C&D), 404-562-8501



SECTOR-SPECIFIC REGULATORY COMPLIANCE ASSISTANCE

COMPLIANCE ASSISTANCE CENTERS

Make sense of environmental regulations, in terminology directly related to your industry. Save money on compliance and reduce wastes. Sectors include: chemicals, printing, auto repair, and more.

www.epa.gov/compliance/assistance

Wesley Hardegee, 404-562-9629

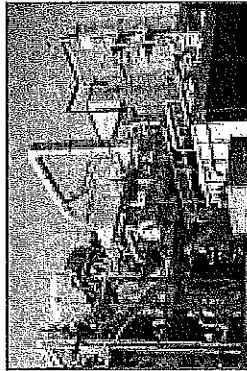

Mills like the one above can get help with environmental regulations.

INDUSTRY SECTOR NOTEBOOKS

Profiles environmental challenges for more than 35 manufacturing, transportation and agricultural sectors. Covers typical operations, pollutants, regulations, P2 opportunities, common environmental violations, and voluntary initiatives.

www.epa.gov/compliance/sectornotebooks.html

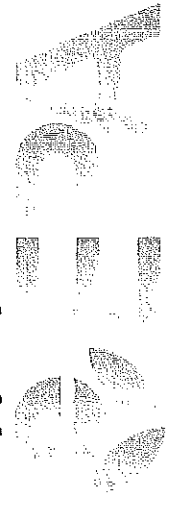

United States Environmental Protection Agency
Mention of trade names, products, or services does not convey official EPA approval, endorsement, or recommendation.

STATE POLLUTION PREVENTION (P2) RESOURCES

Find all the P2 State contacts at:

~ <http://wrrc-p2pays.org>

EPA partnership programs and general P2
~ www.epa.gov/partners and www.epa.gov/p2

Buy environmentally responsible computers
~ www.epeat.net

Recycling opportunities for practically everything.
~ www.earth911.org

Best management practices/Lower plant energy bills
~ www1.eere.energy.gov/industry

ADDITIONAL SUCCESS STORIES

~ EPA's Colorado Lab—Reduces water usage 50%, saving 650,000 gallons, and \$1,900/yr.

~ Retail complex in Oregon uses native landscaping—maintenance costs reduced 80%, and water bill \$2,400.

~ Fiberglass Mfr. reduces waste acetone by 80%, goes from Small Quantity Generator (SQG) to Conditionally Exempt Small Quantity Generator (CESQG).

~ Dow reconditions steel drums, Saves \$2.3 million, conserves 7.8 million lbs of steel.

~ Seydel's (textiles) reduction & re-manufacturing efforts generates \$518,000 in revenue.

~ Institute for Local Self-reliance (ISLR) deconstructs/recycles home, nets \$7,400 in materials.

Make your pockets GREENER with Voluntary Programs

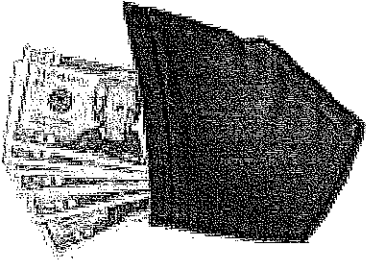

EPA has over 60 voluntary programs to help you reduce waste, understand legal requirements, and save millions; with flexible, market-driven solutions. Other companies have saved millions of dollars...and so can you!



ENVIRONMENTAL PROTECTION AGENCY
REGION 4

61 Forsyth St.
Atlanta, GA 30303
www.epa.gov/region4

For More Information Contact
Waste Reduction Resource Center

1-800-476-8686

APPENDIX D

APPENDIX D

Capital Projects Work Plan

The Capital Projects Work Plan consists of this narrative and three exhibits: The projects' descriptions attached as Exhibit D-1 (including the separate list of Asbestos Cement force mains that make up Project 4.9 and the separate list of individual pump station improvement descriptions that make up Projects 5.14 through 5.18 inclusive); the projects' schedules with milestones attached as Exhibit D-2; and the projects' cost schedule attached as Exhibit D-3. Although the costs of individual projects (identified with a unique project number) are in 2013 dollars, the total cost of individual projects reflect a two percent (2%) annual inflation rate commencing in FY '14-'15.

Miami-Dade County's Water and Sewer Department ("MDWASD" or "the Department") held three (3) public workshops on September 24, 25 and 27, 2012 in the North, South and Central areas of the County, respectively, to receive community input on the capital improvement projects. The Department also solicited written comments on its website. The Department considered the public's comments prior to finalizing the list of capital projects shown in Exhibit D-1.

In establishing the schedules for the Capital Projects Work Plan shown in Exhibit D-2, MDWASD took into consideration operational and project implementation factors which include sequencing projects to keep the system operational and time to design, procure, construct and commission the projects.

These schedules reflect the need to maintain the operational viability of the Department's wastewater collection, pump stations, transmission, treatment and disposal systems in a manner

that will minimize service interruptions, sanitary sewer overflows or non-compliance with effluent standards. The sequencing involves limiting the number of functional components that are out of service at one time at each of the plants and ensuring that flows can be directed away from plants with limited capacity due to repair and replacement work. This means that the work must be sequenced among the three plants as well as within each of the plants. Many of the projects must be done during the dry season when average daily flows are low, so that fact also extends the schedule for plant repairs. For the purpose of establishing priorities, the Department factored the criticality of each individual project in the context of public health, welfare and safety, operational constraints and environmental significance.

Based on this rationale, most of the collection, transmission and pump station projects have been assigned similarly high priorities and are scheduled to commence at the start of FY '13 - '14. A major exception to these is the Government Cut project. Phases 1 & 2 are currently budgeted and under construction. In addition, the preliminary design of Phase 3 is currently underway and is scheduled for completion during FY '12 - '13.

As shown on Exhibit D-2 of this work plan, almost all of the identified wastewater collection and transmission system projects, together with the wastewater pump stations system projects, are front-loaded and scheduled for completion within the first five years of the Consent Decree. The sole exceptions are the Collection System I/I Repairs project and the Replacement of Asbestos Cement Force Mains project. The former is part of an on-going program for which we are proposing funding throughout the life of the Consent Decree. Note that the Collection System I/I Repairs project which includes inspection of approximately six thousand (6,000) miles of pipe will be performed concurrently with all other work. The Asbestos Cement Force

Main project consists of the replacement of sixty-six (66) individual force mains which are projected to be completed by the end of the sixth year.

The schedule of each project includes time for engineering design, permitting, procurement and construction. Although the schedule allocates permitting time of one (1) year for each project, the actual time to obtain a permit will vary depending on the type and location of the project. For projects that are located within a municipality, MDWASD or its contractor must obtain a municipal building permit and has no control over each municipality's requirements and review time for issuing a permit. Additionally, there may be several types of permits required, including electrical, mechanical and structural permits. Permits are normally obtained as part of the design process so that construction bids will reflect the conditions imposed by permitting authorities for maintenance of traffic, allowable working hours, and site restoration requirements. Allocating one year should be sufficient time for obtaining all permits regardless of where the project is located. With regard to procurement, MDWASD intends to accelerate the County Commission's internal approval process but must comply with Florida's competitive bidding laws.

Scheduling of capital projects associated with the three (3) regional treatment plants presents the greatest challenge inasmuch as taking units and/or processes out of service needs to be done in a way that does not adversely affect the operational capacity of the plants. For this reason, a large number of these projects needs to be sequenced in a fashion wherein the unit or process is placed out of service during the dry season, normally from the end of November to the end of May. Another scheduling variable taken into consideration is the need to divert flows from one treatment plant to another while work that limits the plant's hydraulic capacity is being

performed. Finally, the State's Ocean Outfall Legislation is another factor to consider in scheduling the work at the Central and North District WWTPs. The legislation may impact the work schedule. The Ocean Outfall Legislation currently requires diverting almost all flows from the outfalls by 2025. This, in turn, requires adding at least High Level Disinfection (filtration and disinfection) to all of the North and Central District flows. In addition, the legislation requires significant reuse of these flows. Existing site constraints may well result in the need to construct one or more entirely new plants in more westerly locations, thereby potentially requiring alterations to the collection system. This Capital Projects Work Plan assumes that the existing plants will be overhauled in their present locations, an assumption that may need to be altered as the outfall plan develops. It is also possible that changes to the Ocean Outfall Legislation will be made during the next or future legislative sessions, and such changes could also impact the Work Plan. Although design activities for many of the treatment plants' projects are scheduled to commence shortly after the Effective Date of the Consent Decree, there are several projects whose completion extends beyond 10 years after the Effective Date. The following are explanations for the proposed length and completion dates of these specific projects.

Project 1.3 - SDWWTP Oxygenation Train Rehabilitation

This project does not start at the beginning of the Consent Decree because recent tank cleanings, minor structural rehabilitation, mixer replacements for energy efficiency and process modifications have improved the conditions of these units. However, the oxygenation trains will require extensive maintenance during the proposed life of the Consent Decree. The construction phase for the extensive rehabilitation of these units is scheduled for mid-2018, which is well

before deterioration would be severe enough to result in tank failure or compromise the treatment process. Construction will require seven (7) years for completion because the tanks are a critical part of secondary treatment that is highly sensitive to hydraulic conditions. Therefore, it is advisable for these units to be out of service during the dry weather periods of the year.

Additionally, in order to ensure that a tank can be fully rehabilitated during the dry season, and that firm plant capacity is maintained at all times, only one tank will be rehabilitated per year.

Projects 2.5 and 2.6 – Central District WWTP Plants 1 and 2 Oxygenation Train Rehabilitation

The construction phase of these projects will require six (6) years for completion because the tanks are a critical part of the secondary treatment that is highly sensitive to hydraulic conditions. Therefore, it is only advisable for these units to be out of service during the dry weather periods of the year. Additionally, in order to ensure that a tank can be fully rehabilitated during the dry season, and that firm plant capacity is maintained at all times, only one (1) tank will be rehabilitated per year.

Projects 2.7, 2.8, 2.9 and 2.10 – Central District WWTP Plants 1 and 2 Secondary Clarifiers and Return Sludge Pump Stations

Currently, fibrous and other material accumulations that include rags, paper, plastic and hair, and solids deposition result in failure of the sludge collection mechanism in the secondary clarifiers. The construction phases of the secondary clarifier projects are not scheduled to start prior to the construction and full operation of the Central District WWTP's headwork project since this project will target rag and solids removal upstream of the secondary clarifiers.

Under normal circumstances it would be advisable to have only one (1) clarifier out of service per plant at the Central District WWTP. However, the physical pairing of a return sludge

pump station with the corresponding secondary clarifiers at the Central District WWTP dictates that two (2) clarifiers and their paired pump station be rehabilitated at the same time for ease of construction. However, this pairing is also required in case the removal and replacement of badly corroded return sludge pipes from one clarifier causes damage to the adjacent clarifier's structure and return sludge pipes. The construction phase for each pair of clarifiers and their shared return sludge pump station will take approximately one (1) year. Since there are sixteen (16) secondary clarifiers and eight (8) return sludge pump stations at the Central District WWTP, the full construction phase of these two (2) projects is eight (8) years.

Projects 2.14 and 2.15 -- Central District WWTP Plant 1 and 2 Digesters

The level of deterioration and complexity of the anaerobic digesters requires that each cluster of four (4) digester tanks be taken completely out of service for extensive masonry and steel structural repairs; complete replacement of pipes, valves, sludge mixing equipment, heat exchangers and pumps; demolition of failed floating covers and installation of new covers. Since these units were built at different times, the six (6) digester clusters reflect different design and construction methods. Accordingly, the rehabilitation of each cluster will require an individual design effort. For these reasons, the construction phase of each digester cluster has been conservatively estimated to take the better part of two (2) years. It must be emphasized that this is an estimated construction time based on similar level of work being performed on each cluster. Until a detailed design for the rehabilitation required for each digester cluster is sufficiently complete, a more realistic construction time estimate for each cluster will not be available. The current estimate for the entire construction phase of all digesters is ten (10) years, with only one (1) digester cluster taken out of service at a time.

Projects 3.2 and 3.5 – North District WWTP Primary and Secondary Clarifiers

Currently, fibrous and other material accumulations that include rags, paper, plastic and hair, and solids deposition result in failure of the sludge collection mechanism in the primary and secondary clarifiers. The construction phase of the clarifier projects is not scheduled to start until the North District WWTP headwork project is completed because this project will target rag and solids removal upstream of the primary and secondary clarifiers. Also, the construction phase for these projects cannot commence until completion of the Central District WWTP's headwork project because that project will require a substantial diversion of flows to both the South District WWTP and the North District WWTP. Hence, the North District WWTP's full capacity must be made available during that time.

Both primary and secondary clarifiers at North District WWTP have a unique feature among the county's treatment plants in that the tanks are enclosed structures for odor control purposes. The voluminous metal enclosures create hot, humid and corrosive environments that attack exposed electrical, mechanical and air handling equipment along with metal and concrete structures. The resulting impacts are most prevalent in the primary clarifiers as the hydrogen sulfide concentrations are highest prior to oxidation in the oxygenation trains. For this reason the primary clarifiers will be rehabilitated prior to the secondary clarifiers. Primary and secondary clarifiers will not be rehabilitated in tandem as the reduced capacity of primary clarifiers during construction will cause hydraulic conditions that could result in solids carry over into the secondary treatment process. Solids carry over would stress the surface loading rate of secondary clarifiers and the return sludge pumping operations. The additional hydraulic stress of having secondary clarifiers out of service at the same time will adversely impact activated sludge

settling, and could result in high TSS/CBOD concentrations in the plant's effluent during said rehabilitation.

Exhibit D-1 Capital Project Descriptions

Project Number	Project Name	Project Description	Project Impact/Need
		South District WWTP, 8950 SW 232 St, Goulds, FL 33170	
1.1	Headworks	Routine repairs on existing bar screen mechanisms in headwork structure prior to aerated grit chambers	Failure of bar screen mechanism could result in the blinding of the bar screen and cause an overflow of raw sewage from the plant headworks structure towards nearby surface waters, especially during peak wet weather.
1.2	Oxygen Production	Replacement and retrofit of existing air compression units .	Replacements and modifications are needed to meet WWTPs 125 ton oxygen demand. Loss of pure oxygen production will affect performance of secondary treatment process and result in effluent limit violations.
1.3	Oxygenation Trains	Aeration mixers retrofit, structural rehabilitation, and surface coating application	Loss of aeration tank capacity will result in effluent limit violations.
1.4	Chlorine Building	Replacement of motor control centers, relocation of electrical panels and roof repairs of old chlorine building where flushing water pumps are to remain.	Roof leaks or failure of MCC and electrical panel could result in loss of plant flushing water which is used for spray systems and odor control.
1.5	Effluent Pump Station	Upgrade of existing obsolete pump control systems, upgrade pumps drives and motors and structural rehabilitation of pump station wet well chambers 2-4.	Loss of pumping capacity or wet well function will result in unpermitted effluent discharge into the surrounding surface waters.
1.6	Gravity Sludge Thickeners	Replacement of thickened sludge pumps, and electrical systems in concentrator pump station. Rehabilitation of concentrator collector mechanisms and structural rehabilitation and coating of concentrators.	Failure of sludge thickening will result in a biological overloading of the secondary treatment process and effluent limit violations.
1.7	Digesters and Control Buildings	Rehabilitation or replacement of digester roofs, digester tank cleaning, structural rehabilitation and coating, sludge mixers improvement	Loss of digestion capacity will result in a decline in biogas/methane production for power generation and unstabilized sludge that will require landfill disposal.
1.8	Dewatering Facility	Replace existing Intertin dewatering building with a new permanent dewatering facility, to include centrifuges, controls, polymer system, structural, mechanical and electrical systems.	Failure of sludge dewatering would result in solids accumulation in the secondary treatment process and effluent limit violations.
1.9	FOG Removal Facility	Separation operations improvements to recently constructed FOG removal facility to aid in conveyance of oils and floating grease to beneficial use option and removal of excess grit and settled solids.	Current FOG separation tank is not capable of adequately handling solids load, resulting in excess odors and unanticipated manual labor to remove large amounts of grit, settled soils and hardened grease.
1.10	Odor Control	Upgrade odor control facilities	Complaints of nuisance odors by nearby residents could result from a lack of properly functioning odor control systems.
1.11	General Electrical	Rehabilitation and replacement of electrical controls and wiring as needed.	Loss of electrical controls or wiring could result in plant shutdowns, wastewater overflows and effluent violations.
1.12	Chlorine Contact Chamber Structural	Structural rehabilitation and coating of chlorine contact chambers 1-4	Structural failure of a chlorine contact chamber would lead to a lack of disinfection contact time, an effluent violation. A hydraulic overload could also occur from multiple chambers being out of service for corrective maintenance, resulting in an effluent spill to nearby surface waters.

Exhibit D-1 Capital Project Descriptions

Project Number	Project Name	Project Description	Project Impact/Need
		Central District WWTP, 3989 Rickenbacker Causeway, Miami, FL 33149	
2.1	Electrical Improvements	Rehabilitation and replacement of electrical controls and wiring as needed	Loss of electrical controls or wiring could result in plant shutdowns, wastewater overflows and effluent violations.
2.2	Building improvements	Repairs to maintenance, operations control and administration buildings to include refurbishing of roofs and staff facilities	These improvements are needed to provide staff with adequate and safe facilities to perform their jobs.
2.3	Headworks Plant 1	Headworks retrofit to include addition of influent screens and an electrical room with replacement of electrical systems	Failure of headwork electrical system will result in grit accumulation in secondary treatment process leading to effluent limit violations. Lack of headworks screening results in accumulation of rags and plastics in plant processes, leading to pump, mixer and clarifier collection mechanism failure; and effluent limit violations.
2.4	Headworks Plant 2	Headworks retrofit to include addition of influent screens and an electrical room with replacement of electrical systems	Failure of headwork electrical system will result in grit accumulation in secondary treatment process leading to effluent limit violations. Lack of headworks screening results in accumulation of rags and plastics in plant processes, leading to pump, mixer and clarifier collection mechanism failure; and effluent limit violations.
2.5	Oxygenation Trains Plant 1	Aeration mixers retrofit, structural rehabilitation, and surface coating application	Loss of oxygenation tank capacity will result in effluent limit violations.
2.6	Oxygenation Trains Plant 2	Aeration mixers retrofit, structural rehabilitation, and surface coating application	Loss of oxygenation tank capacity will result in effluent limit violations.
2.7	Secondary Clarifiers Plant 1	Structural rehabilitation and replacement of sludge collection mechanisms	Loss of sludge settling capacity will result in effluent limit violations.
2.8	Secondary Clarifiers Plant 2	Structural rehabilitation and replacement of sludge collection mechanisms	Loss of sludge settling capacity will result in effluent limit violations.
2.9	RS Pump Stations Plant 1	replacement of return sludge pump, piping, motor control centers and structural repairs to pump stations	Loss of return sludge pumping capacity will result in a failure of the aeration process and effluent limit violations.
2.10	RS Pump Stations Plant 2	replacement of return sludge pump, piping, motor control centers and structural repairs to pump stations	Loss of return sludge pumping capacity will result in a failure of the aeration process and effluent limit violations.
2.11	Effluent Pump Station	Pump replacement in effluent pump station	Loss of sufficient pumping capacity will result in unpermitted effluent discharge into the surrounding surface waters.
2.12	Sludge Thickeners Plant 1	Replacement of thickened sludge pumps, sanitary sewer pumps, HVAC and electrical systems in concentrator pump station. Rehabilitation of concentrator collector mechanisms and structural rehabilitation and coating of concentrators.	Failure of sludge thickening will result in a biological overloading of the secondary treatment process and effluent limit violations.
2.13	Sludge Thickeners Plant 2	Replacement of thickened sludge pumps, sanitary sewer pumps, HVAC and electrical systems in concentrator pump station. Rehabilitation of concentrator collector mechanisms and structural rehabilitation and coating of concentrators.	Failure of sludge thickening will result in a biological overloading of the secondary treatment process and effluent limit violations.
2.14	Digesters Plant 1	Complete rehab of sludge digester clusters (roofs, concrete structures, recirculation & transfer pumps, mixers, & electrical systems)	Loss of digestion capacity will result in a decline in biogas/methane production for power generation and unstabilized sludge that will require landfill disposal.
2.15	Digesters Plant 2	Complete rehab of sludge digester clusters (roofs, concrete structures, recirculation & transfer pumps, mixers, & electrical systems)	Loss of digestion capacity will result in a decline in biogas/methane production for power generation and unstabilized sludge that will require landfill disposal.
2.16	Dewatering Building	Construction of a new dewatering facility and sludge cake conveyance system to sludge storage buildings	Failure of sludge dewatering would result in solids accumulation in the secondary treatment process and effluent limit violations.

Exhibit D-1 Capital Project Descriptions

Project Number	Project Name	Project Description	Project Impact/Need
		Central District WWTP, 3989 Rickenbacker Causeway, Miami, FL 33149 (continued)	
2.17	Chlorination Facilities	Replacement of chlorine gas storage, liquid chlorination and dosing system with bulk sodium hypochlorite storage and dosing system in separate outdoor structures	Failure of existing chlorine gas storage system could lead to and unregulated discharge of chlorine gas and exposure of plant personnel and nearby community to chlorine gas. Additionally, a failure of the chlorine system would result in a lack of disinfection of effluent, a effluent violation.
2.18	Odor Control Systems	Odor control buildings motor control center replacement including air conditioned electrical rooms. Replacement of odor control chemical pumps, piping, valves and gas stripping tower media.	Complaints of nuisance odors by nearby residents could result from a lack of properly functioning odor control systems.
2.19	Co-Gen Facility	Installation of two new Cogeneration engines, Cogeneration Building improvements, replacement of biogas pipeline and installation of biogas conditioning system.	Sudden loss of cogeneration engines could result in partial loss of power to the plant and temporary equipment shutdown. Consistent lack of cogeneration units would result in loss of heat for the anaerobic digesters.
2.20	Septage Unloading	Construction of a new septage handling station to remove FOG from the main wastewater treatment stream and treat effluent through digestion or off-site third part facility.	Septage currently puts and added load on plant's secondary treatment, is labor intensive.
2.21	Pump Station 1	Rehabilitation of pump station odor control system and of bar screen mechanisms	Odor complaints could result from an improperly functioning odor control system. Failure of bar screen mechanism could result in the blinding of the bar screen and cause an overflow of raw sewage from the pump station towards nearby surface waters, especially during peak wet weather flow events.
2.22	Pump Station 2	Rehabilitation of pump station odor control system, rehabilitation of bar screen mechanisms, and replacement pump stations flow metering to improve maintenance accessibility	Odor complaints could result from an improperly functioning odor control system. Failure of bar screen mechanism could result in the blinding of the bar screen and cause an overflow of raw sewage from the pump station towards nearby surface waters, especially during peak wet weather flow events. Inability to access the station's flow meter in a timely fashion has resulted in periods without proper flow measurement from this pump station.
2.23	O2 Plant Process Controls Phase 2	Replacement of process control equipment for existing oxygen production systems either due to equipment failing or being obsolete.	Loss of pure oxygen production will affect performance of secondary treatment process and result in effluent limit violations.
2.24	Gas Monitoring	Gas monitoring and alarms in hazardous areas	Personnel could be overcome by noxious fumes such as hydrogen sulfide, carbon dioxide carbon monoxide or methane if unaware of their presence due to lack of gas monitoring.
2.25	Ventilation Improvements	Ventilation Improvements in Hazardous Areas	Sufficient ventilation in hazardous areas is required to meet NFPA 820.
2.26	Rehabilitation of Walkways and Stairways	Replacement of corroded walkways, stairways, railings, grating throughout the plant	Personnel could suffer falling injuries from eroding concrete and corroding metal.
2.27	Oxygen Production	Construction of a new 30 ton/day oxygen production cryogenic tower and air compression unit to provide full redundancy as existing units are near the end of useful life and prone to failure.	Loss of pure oxygen production will affect performance of secondary treatment process and result in effluent limit violations.
2.28	SCADA RTU Upgrades	SCADA RTU upgrades due to existing RTUs being obsolete and difficulty of locating replacement parts	Failure to upgrade these RTUs could result in loss of monitoring and control of unit processes
2.29	High Strength Influent Impact Study	Investigation as to the sources of increased TSS and BOD loading experienced at the plant and conceptual solutions to eliminate or mitigate the change in plant influent characteristics	Influent loading characteristics well above design parameters are contributing factors in effluent limit violations. If unaddressed, continued effluent violation are likely.

Exhibit D-1 Capital Project Descriptions

Project Number	Project Name	Project Description	Project Impact/Need
		North District WWTP, 2575 NE 156 St., North Miami, FL 33160	
3.1	Headworks and Sludge Degrubing Transfer	Phase 1: Replacement of bar screens with perforated plate screens Phase 2: Upgrade pretreatment buildings for fire code compliance and replacement of primary sludge grit separation	Replacement of influent screens and upgrade of headworks will reduce rags problems and improve treatment process.
3.2	Primary Clarifiers and Odor Control	Rehabilitation of structural, mechanical and odor control systems	Loss of primary clarifier capacity will increase workload of the secondary treatment process and will result in effluent limit violations. Complaints of nuisance odors by nearby residents could result from a lack of properly functioning odor control systems.
3.3	Oxygenation Trains	Rehabilitation of Aeration Tanks structural, mechanical and electrical systems	Loss of oxygenation tank capacity will result in effluent limit violations.
3.4	Oxygen Production	Rehabilitation of oxygen plant structural, mechanical and electrical systems	Loss of pure oxygen production will affect performance of secondary treatment process and result in effluent limit violations.
3.5	Secondary Clarifiers	Structural, mechanical and electrical rehabilitation of the secondary clarifiers	Loss of sludge settling capacity will result in effluent limit violations.
3.6	Disinfection	Replacement of chlorine gas storage, liquid chlorination and dosing system with bulk sodium hypochlorite storage and dosing system in the existing chlorine building	Failure of existing chlorine gas storage system could lead to and unregulated discharge of chlorine gas and exposure of plant personnel and nearby community to chlorine gas. Additionally, a failure of the chlorine system would result in a lack of disinfection of effluent, a effluent violation.
3.7	Effluent Disposal	Installation of standby pumps to ensure effluent disposal capacity and structural rehabilitation of ocean outfall pump station wet well	Loss of sufficient pumping capacity or wet well function will result in unpermitted effluent discharge into the surrounding protected wetlands.
3.8	Plant Wide Electrical	Rehabilitation and replacement of electrical controls and wiring as needed	Loss of electrical controls or wiring could result in plant shutdowns, wastewater overflows and effluent violations.
3.9	Flood Mitigation	Generator and Electrical Building flood mitigation at NDWWTP	Flooding of emergency standby generator and electrical switchgear area would result in loss of emergency power and power distribution. Emergency power is most critical during storm events when flooding is most likely.
3.10	Yard Piping Replacement	Replacement of wastewater piping that interconnects unit processes throughout the plant	A leak or rupture of plant yard piping will result in sewage and/or sludge spill that may contaminate nearby surface waters.
3.11	SCADA RTU Upgrades	SCADA RTU upgrades due to existing RTUs being obsolete and difficulty of locating replacement parts	Failure to upgrade these RTUs could result in loss of monitoring and control of unit processes

Exhibit D-1 Capital Project Descriptions

Project Number	Project Name	Project Description	Project Impact/Need
Wastewater Collection and Transmission Lines			
4.1	Collection System VI Repairs	Rehab of Collection System (Dig & Replace Mainlines and Laterals, Manhole Replacement, Cured-in-Place Liners and Sectional Liners)	Renewal/replacement of defective gravity sewers with documented excessive inflow/infiltration
4.2	Government Cut FM - Phase 1 & 2 (construction ongoing)	Replace existing portion of 54 inch FM from the water shaft of Phase 1 in Government Cut to mainland Miami Beach	Replace critically damaged sections of 54-inch force main to avert catastrophic failures in Government Cut
4.3	Government Cut FM - Phase 3	Replace existing portion of 54 inch FM from land shaft of Phase 1 at Fisher Island to CDWWTP at Virginia Key	Replace critically damaged sections of 54-inch force main to avert catastrophic failures in Fisher's Cut
4.4	North Dade 72 inch PCCP FM Rehabilitation	Rehabilitation of the remaining 3.5 miles of the 72 inch PCCP FM located between NW 17 Ave and NE 10 Ave	Replace remaining damaged section of 72-inch force main that has experienced catastrophic failure
4.5	South Dade 54 inch PCCP FM Rehabilitation	Rehabilitation of approximately 2.5 miles of 54 inch PCCP FM from SW 112 Ave and SW 280 St to SW 107 Ave and SW 248 St	Replace sections of 54-inch force main that has critically damaged pipe segments
4.6	Replacement of Tamiami Canal Aerial Crossing FM's at NW 37th Ave	Replace corroded twin 24 inch FM's crossing the Tamiami Canal at NW 37 Ave, just south of NW 21 St	Replace twin 24-inch force mains that are corroded and have experienced failures
4.7	Replacement of 18 inch DIP FM in Miami Lakes	Replace 1 mile of corroded 18 inch DIP FM located at NW 60 Ave and NW 138 St	Replace severely corroded 18-inch pipe that has had multiple failures
4.8	Rehabilitation of 54 inch PCCP FM in the City of Miami	Rehabilitate by Cured-in-Place liner approximately 2 miles of 54 inch PCCP FM located on NW 2 St between NW 67 Ave and NW 37 Ave	Complete rehabilitation of 54-inch force main that is deteriorated and has experienced failures
4.9	Replace Approximately 25 miles of AC force mains	See attached description of individual force mains	Replace asbestos cement force mains that have experienced failures and are difficult to locate in the field.
4.10	Opa-Locke Airport 48" PCCP force main replacement	Rehabilitation of 2.5 miles of 48" PCCP force main running along the Biscayne Canal between NW 57th Avenue & NW 32 nd Avenue	Complete rehabilitation of 48-inch force main that is deteriorated and determined to have approximately one quarter of its line segments distressed based on in-situ condition assessments

Exhibit D-1 Capital Project Descriptions

Project Number	Project Name	Project Description	Project Impact/Need
Sewer Pump Station Systems			
5.1	Upgrade of PS#0418	Cover PS# 418 into a booster type station	The station has reach the end of its useful life. Booster station is needed to relieve pressures in the Doral area.
5.2	Upgrade of PS#0691	Replacement of pumping and electrical equipment	Existing equipment is beyond its useful life. Station capacity increase is required to handle increased Homestead flows
5.3	Upgrade of PS#0692	Replacement of pumping and electrical equipment	Existing equipment is beyond its useful life. Station capacity increase is required to handle increased Homestead flows
5.4	Replacement of Switchgear PS#0414	Replacement of electrical switchgear	Existing equipment is beyond its useful life.
5.5	Replacement of Switchgear and Rehabilitation of Wet well PS#0415	Replacement of electrical switchgear and rehabilitation of the wet well to include a odor control unit	Existing equipment is beyond its useful life. Wet well structure is deteriorated badly due to H2S
5.6	Replacement of Switchgear PS#0416	Replacement of electrical switchgear	Existing equipment is beyond its useful life.
5.7	Replacement of Switchgear and Rehabilitation of Wet well PS#0417	Replacement of electrical switchgear and rehabilitation of the wet well to include a odor control unit	Existing equipment is beyond its useful life. Wet well structure is deteriorated badly due to H2S
5.8	Replacement of Electrical and Mechanical Equipment in PS#0107	Replacement of pumping and electrical equipment	Existing equipment is beyond its useful life. Parts are not readily available for the load cell type controllers
5.9	Replacement of Plumbing and Electrical Equipment at PS#0301	Replacement of pumping and electrical equipment to include generator	Existing equipment is beyond its useful life due to the saltwater environment
5.10	Upgrade of PS#0488	Conversion of pump station to submersible type station	Existing equipment is beyond its useful life.
5.11	Installation of 60 inch FM from Kendall Dr to PS#0536	Installation of 60" FM from Kendall Dr to PS#0537 to eliminate the 42" reduction in the 60" FM	To reduce pressure differential and increase flow transfer between PS#0559 and 0536
5.12	Replacement of Switchgear at PS#0187	Replacement of Anvic Drive with VFD	Existing equipment is beyond its useful life. Parts are not available
5.13	Retrurbish Emergency Generators and Controls at Regional Pump Stations	Retrurbish emergency generators and controls at regional pump stations due to parts obsolescence	Emergency backup generators are unreliable due to age of controllers and condition of wiring on the engines
5.14	Upgrade of PS #0086, 0492	See attached Pump Station Compliance Projects sheet for individual pump station project descriptions.	The pump stations are out of compliance of the Adequate Transmission Capacity Criteria with a NAPOT of greater than 10 hours.
5.15	Upgrade of PS #0065, 0201, 0334, 0374, 0607	See attached Pump Station Compliance Projects sheet for individual pump station project descriptions.	The pump stations are out of compliance of the Adequate Transmission Capacity Criteria with a NAPOT of greater than 10 hours.
5.16	Upgrade of PS #00198, 0437, 0466, 0680	See attached Pump Station Compliance Projects sheet for individual pump station project descriptions.	The pump stations are out of compliance of the Adequate Transmission Capacity Criteria with a NAPOT of greater than 10 hours.
5.17	Upgrade of PS #0037, 0351, 0370, 0403	See attached Pump Station Compliance Projects sheet for individual pump station project descriptions.	The pump stations are out of compliance of the Adequate Transmission Capacity Criteria with a NAPOT of greater than 10 hours.
5.18	Upgrade of PS #0441, 0491, 0710, 0827, 0852, 1236	See attached Pump Station Compliance Projects sheet for individual pump station project descriptions.	The pump stations are out of compliance of the Adequate Transmission Capacity Criteria with a NAPOT of greater than 10 hours.
5.19	SCADA RTU Upgrades	SCADA RTU upgrades for 635 pump stations due to existing RTUs being obsolete and difficulty of locating replacement parts	Failure to upgrades these RTUs could result in loss of monitoring and control of wastewater pump stations

Exhibit D-1, Individual AC Force Mains in Project 4.9

Line	Pipe Length	Diameter	From Location	To Location	Atlas Page	As Built Type	As Built No	As Built Sheet
1	2757	12	SW 112 Ave & SW 104 St	SW 112 Ave & SW 112 St	S21	NA	NA	NA
2	2000	8	NE 14 Ave & 191 St	NE 14 Ave & Miami Gardens Dr	D2	ES	4708	1, 2
3	1520	6	PS 356	NW 53 Ct & NW 195 Dr	L2	ES	836	4
4	1430	8	NW 53 Ct & NW 195 Dr	NW 52 Ct & NW 191 St	L2	ES	836	4
5	920	10	NW 52 Ct & NW 191 St	NW 52 Ct & NW 188 St	L2	ES	836	4
6	276	6	PS 362	NW 52 Ct & NW 190 St	L2	ES	793	8
7	400	10	NW 52 Ct & NW 190 St	NW 52 Ave & NW 189 Ter	L2	ES	793	8
8	1650	10	NW 52 Ct & NW 188 St	NW 52 Ave & NW 183 St	L2	ES	836	5
9	1492	8	PS 385	NW 29 Ct & NW 199 St	J1	ES	826	4
10	1080	12	NW 29 Ct & NW 199 St	NW 30 Pl & NW 199 St	J1	ES	826	4
11	400	8	NW 29 Ct & NW 199 St	NW 28 Ave & NW 199 St	J1	ES	830	3
12	310	6	PS 374	NW 28 Ave & NW 199 St	J1	ES	830	3
13	3235	12	NW 30 Pl & NW 199 St	NW 37 Ave & NW 199 St	J1	ES	823	4
14	1785	8	PS 368	NW 37 Ave & NW 194 Ter	J2	ES	834	2
15	896	4	PS 375	NW 29 Pl & NW 191 St	J2	ES	818	6
16	896	10	PS 427	NW 29 Pl & NW 191 St	J2	ES	922	1
17	1076	10	NW 29 Pl & NW 191 St	NW 32 Ave & NW 191 St	J2	ES	818	6
18	2614	6	PS 376	NW 32 Ave & NW 191 St	J2	ES	782	7
19	1450	6	PS 377	NW 36 Ave & NW 183 St	J2	ES	797	1
20	467	8	PS 366	NW 42 Pl & NW 199 Ter	K2	ES	808	5
21	1792	10	NW 42 Pl & NW 199 Ter	NW 39 Ct & NW 199 St	K2	ES	808	5
22	2056	6	PS 358	PS 352	K3	ES	775	12
23	11027	8	PS 1022	PS 1072	AA36,	ES	4597	1
24	1793	8	PS 353	NW 48 Ct & NW 178 Ter	L3	ES	780	15
25	1425	10	NW 52 Ave & NW 173 Dr	NW 52 Ave & NW 178 Terr	L3	ES	788	12
26	2025	6	PS 354	NW 52 Ave & NW 173 Dr	L3	ES	788	12
27	2450	4	Pvt PS @ SW 149 Ter	MH 14 @ PS 719	Q23 Q24	ES	676	1
28	1610	8	PS 786	MH 5 @ PS 785	R15	U	93	1
29	1350	12	PS 811	SW 107 Ave & SW 76 St	R19	U	136	1
30	2745	12	PS 811	SW 102 Ave & SW 81 St	R19	U	123	3
31	2168	10	PS 812	SW SW 102 Ave & SW 84 St	R19	U	411	1
32	1622	12	SW 107 Ave & SW 104 St	SW 107 Ave & Kendall Blvd	R20	U	245	2
33	1266	4	Pvt PS @ SW 1104 Ave & SW 169 St	MH 59 @ SW 103 Ave	R25	ES	741	1
34	6612	10	PS 709	Homestead Ave & Kumquat St	R25	ES	739	1
35	2505	6	SW 110 Ave & Banyan St	SW 95 Ave & SW Banyan St	R25	N/A	N/A	N/A
36	649	4	PS 721	US1 & Banyan St	R25	ES	701	1
37	767	4	PS 749	PS 731	R25	ES	650	2
38	1066	4	PS 747	US1 & Enst Indigo St	R25	N/A	N/A	N/A
39	1418	10	SW 102 Ave & SW 176 St	Homestead Ave & West Jessamine	R25	ES	687	8
40	4017	8	PS 745	SW 102 Ave & SW 176 St	R25	ES	687	8
41	1386	4	PS 731	SW Duval Ave & West Indigo St	R25	ES	741	1
42	3769	10	SW 102 Ave & West Jessamine	US 1 & SW 184 St	R25	ES	739	2
43	1858	12	Homestead Ave & SW 180 St	Railroad St & SW 184 St	R25	ES	739	2
44	1200	8	PS 810	SW 118 Pl & SW 72 St	S19	U	243	1
45	650	12	PS 793	SW 118 Pl & SW 72 St	S19	U	243	1
46	666	6	PS 724	SW 106 Ave & SW 155 St	S24	ES	734	1
47	973	8	PS 869	SW 122 Ave & SW 88 St	T20	U	149	5
48	1822	10	PS 1017	SW 123 Pl & SW SW 268 St	T31	ES	1039	3
49	3412	10	PS 1029	SW 132 Ave & SW 268 St	U30	ES	1044	1
50	3649	8	SW 137 Ave & SW 268 St	SW 128 Ave & SW 268 St	U31	ES	1040	6
51	6432	10	PS 1028	SW 137 Ave & SW 288 St	U31	ES	1040	6
52	5461	10	PS 1027	SW 132 Ave & SW 280 St	U31	ES	1049	4
53	2340	8	PS 1018	MH 44A @ SW 132 Ave	U32	ES	1053	1
54	2680	12	SW 137 Ave & SW 72 St	SW 142 Ave & SW 72 St	V18	U	191	1
55	2363	12	SW 142 Ave & SW 72 St	SW 147 Ave & SW 72 St	V18	U	202	6
56	2451	8	PS 864	SW 147 Ave & SW 72 St	V18	U	202	4
57	1441	8	SW 142 Ave & Kendale Lakes Blvd	SW 140 Ave & Kendale Lakes Blvd	V19	U	420	5
58	2101	10	SW 140 Ave & Kendale Lakes Blvd	SW 137 Ave & Kendale Lakes Blvd	V19	U	420	4
59	776	12	SW 137 Ave & Kendale Lakes Blvd	SW 137 Ave & SW 81 St	V19	U	420	4
60	1420	8	PS 1013	PS 1012	V31	ES	4543	3
61	2213	10	PS 1012	SW 144 Ave & SW 280 St	V31	ES	4543	3
62	958	8	PS 1011	SW 144 Ct & SW 280 St	V31	ES	4544	3
63	6565	10	SW 147 Ave & SW 288 St	SW 134 Pl & SW 288 St	V32	ES	1056	1
64	1236	6	PS 1009	SW 147 Ave & SW 296 St	V32	ES	4547	1
65	1819	6	PS 1006	PS 1005	W32	ES	4594	1
66	2989	8	PS 1002	SW 152 Ave & SW 304 St	W33	ES	4593	3

136839 Feet
25,91648 Miles

Exhibit D-1 Individual Pump Station Projects in Projects 5.14 to 5.19

Pump Station	Project Description
PUMP STATION 0086	Convert to submersible with existing wet well/ Electrical upgrade
PUMP STATION 0492	New submersible PS/ Electrical upgrade
PUMP STATION 0065	New submersible pumps in the existing dry well / Larger suction and discharge piping/ Electrical upgrade
PUMP STATION 0201	New submersible pumps in the existing wet well/ New valve box/ Electrical upgrade
	Complete I/I 48 repairs for 176 gpm
PUMP STATION 0334	New submersible PS/ Electrical upgrade
	2,200 L.F. of new 8" FM
PUMP STATION 0374	New submersible pumps and valve box/ Electrical upgrade
	320 L.F. of new 8" FM
PUMP STATION 0607	New submersible PS/ Electrical upgrade
PUMP STATION 0198	New submersible pumps in the existing dry well / Electrical upgrade
	Flow isolation and I/I repairs as needed
PUMP STATION 0437	New submersible pumps and valve box/ Electrical upgrade
PUMP STATION 0466	New submersible pumps and valve box/ Electrical upgrade
PUMP STATION 0680	New submersible pumps/ New valves above ground/ Electrical upgrade
PUMP STATION 0037	New higher capacity submersible PS / Electrical upgrade
PUMP STATION 0351	New submersible pumps and valve box/ Electrical upgrade
	Replace 360 L.F. of 4" with 8" FM (back yards)
PUMP STATION 0370	New submersible PS/ Electrical upgrade
	760 L.F. of new 8" FM
PUMP STATION 0403	New submersible PS/ Electrical upgrade/ On site generator
PUMP STATION 0441	New submersible PS/ Electrical upgrade
PUMP STATION 0491	Flow isolation and I/I repairs as needed
PUMP STATION 0710	New submersible PS/ Electrical upgrade
	1,800 of L.F. of new 8" FM
PUMP STATION 0827	Larger submersible pumps/ New valve vault/ Electrical upgrade
	Replace 1,600 L.F. of 4" FM with 8" FM
PUMP STATION 0852	New submersible PS/ Electrical upgrade
PUMP STATION 1236	Complete I/I 300 repairs for 130 gpm

ID	Task Name	Duration	Start	Finish
1	South District RAR	4355 days	Fri 11/1/13	Sun 11/16/25
2	1.1 Hascoverts	1507 days	Thu 10/17/15	Sun 2/22/20
3	1.1.1 Engineering Design	209 days	Thu 4/25/16	Thu 4/25/16
4	1.1.2 Permitting	385 days	Wed 4/29/17	Thu 4/29/17
5	1.1.3 Procurement	385 days	Thu 4/29/17	Thu 4/29/17
6	1.1.4 Construction	655 days	Fri 4/27/18	Sun 2/23/20
7	1.2 Oxygen Production	1717 days	Thu 1/1/15	Fri 9/13/19
8	1.2.1 Engineering Design	225 days	Thu 1/1/15	Sun 9/23/15
9	1.2.2 Permitting	385 days	Mon 8/24/15	Mon 8/24/15
10	1.2.3 Procurement	385 days	Thu 8/23/16	Thu 8/23/16
11	1.2.4 Construction	722 days	Wed 8/23/17	Fri 9/13/19
12	1.3 Oxygenation Trains	3303 days	Thu 11/1/16	Sun 11/16/25
13	1.3.1 Engineering Design	259 days	Thu 7/18/17	Thu 7/18/17
14	1.3.2 Permitting	385 days	Wed 7/18/18	Wed 7/18/18
15	1.3.3 Procurement	385 days	Wed 7/18/18	Wed 7/18/18
16	1.3.4 Construction Train 5	123 days	Thu 7/18/19	Sun 11/17/19
17	1.3.5 Construction Train 6	124 days	Fri 7/19/19	Mon 11/18/20
18	1.3.6 Construction Train 7	124 days	Fri 7/19/19	Mon 11/18/20
19	1.3.7 Construction Train 8	124 days	Fri 7/19/19	Mon 11/18/20
20	1.3.8 Construction Train 9	124 days	Fri 7/19/19	Mon 11/18/20
21	1.3.9 Construction Train 10	124 days	Fri 7/19/19	Mon 11/18/20
22	1.3.10 Construction Train 11	124 days	Fri 7/19/19	Mon 11/18/20
23	1.4 Chlorine Building	1278 days	Sat 12/1/16	Wed 8/16/22
24	1.4.1 Engineering Design	131 days	Sat 12/1/16	Wed 4/10/18
25	1.4.2 Permitting	385 days	Thu 4/10/18	Thu 4/10/18
26	1.4.3 Procurement	385 days	Fri 4/10/18	Fri 4/10/18
27	1.4.4 Construction	478 days	Sat 4/10/18	Wed 8/16/22
28	1.5 Effluent Pump Station	2045 days	Thu 9/18/16	Mon 7/10/19
29	1.5.1 Engineering Design	373 days	Thu 9/18/16	Mon 7/10/19
30	1.5.2 Permitting	385 days	Wed 7/11/16	Mon 7/10/19
31	1.5.3 Procurement	385 days	Wed 7/11/16	Mon 7/10/19
32	1.5.4 Construction	1302 days	Thu 7/11/16	Thu 7/10/21
33	1.6 Gravity Sludge Thickener	1728 days	Mon 11/1/16	Sat 9/24/22
34	1.6.1 Engineering Design	230 days	Mon 11/1/16	Sat 9/24/22
35	1.6.2 Permitting	385 days	Mon 8/18/19	Sun 8/18/19
36	1.6.3 Procurement	385 days	Mon 8/18/19	Sun 8/18/19
37	1.6.4 Construction	768 days	Thu 8/18/19	Sat 9/24/22
38	1.7 Disinfectant and Control Building	2619 days	Fri 11/1/13	Thu 10/28/21
39	1.7.1 Engineering Design	288 days	Sat 7/25/14	Sat 7/25/14
40	1.7.2 Permitting	385 days	Sun 7/27/14	Sun 7/27/14
41	1.7.3 Procurement	385 days	Mon 7/27/14	Mon 7/27/14
42	1.7.4 Construction	1821 days	Thu 7/25/18	Thu 10/28/21
43	1.8 Dewatering Facility	1977 days	Thu 7/17/14	Thu 11/28/21
44	1.8.1 Engineering Design	287 days	Thu 7/17/14	Mon 4/13/15
45	1.8.2 Permitting	385 days	Thu 4/14/15	Thu 4/14/15
46	1.8.3 Procurement	385 days	Wed 4/13/15	Wed 4/13/15
47	1.8.4 Construction	900 days	Thu 4/13/15	Thu 11/28/21
48	1.9 FOG Removal Facility	1458 days	Thu 11/7/13	Thu 10/28/21
49	1.9.1 Engineering Design	183 days	Fri 11/7/13	Fri 5/21/14
50	1.9.2 Permitting	385 days	Sat 5/21/14	Sat 5/21/14
51	1.9.3 Procurement	385 days	Sun 5/11/15	Sun 5/11/15
52	1.9.4 Construction	689 days	Mon 5/21/15	Thu 10/27/17
53	1.10 Odor Control	1807 days	Sat 12/1/18	Thu 4/25/23
54	1.10.1 Engineering Design	209 days	Sat 12/1/18	Thu 6/27/19
55	1.10.2 Permitting	385 days	Fri 6/28/19	Fri 6/28/19
56	1.10.3 Procurement	385 days	Sat 6/28/19	Sat 6/28/19
57	1.10.4 Construction	886 days	Thu 11/7/19	Thu 4/25/23
58	1.11 General Electrical	1807 days	Thu 11/7/16	Fri 3/26/21
59	1.11.1 Engineering Design	203 days	Thu 11/7/16	Sun 5/23/17
60	1.11.2 Permitting	385 days	Thu 5/23/17	Thu 5/23/17
61	1.11.3 Procurement	385 days	Thu 5/23/17	Thu 5/23/17
62	1.11.4 Construction	688 days	Wed 5/23/17	Fri 3/24/21
63	1.12 Chlorine Contact Chamber Structural Rehab	1785 days	Mon 8/1/16	Fri 8/18/21
64	1.12.1 Engineering Design	257 days	Mon 8/1/16	Sun 4/17/17
65	1.12.2 Permitting	385 days	Sun 4/17/17	Sun 4/17/17

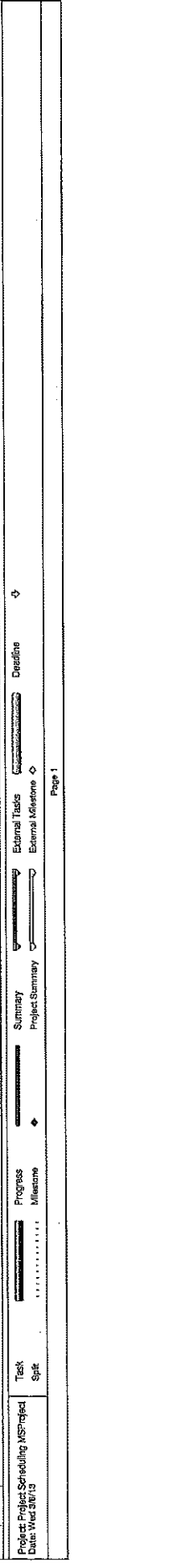

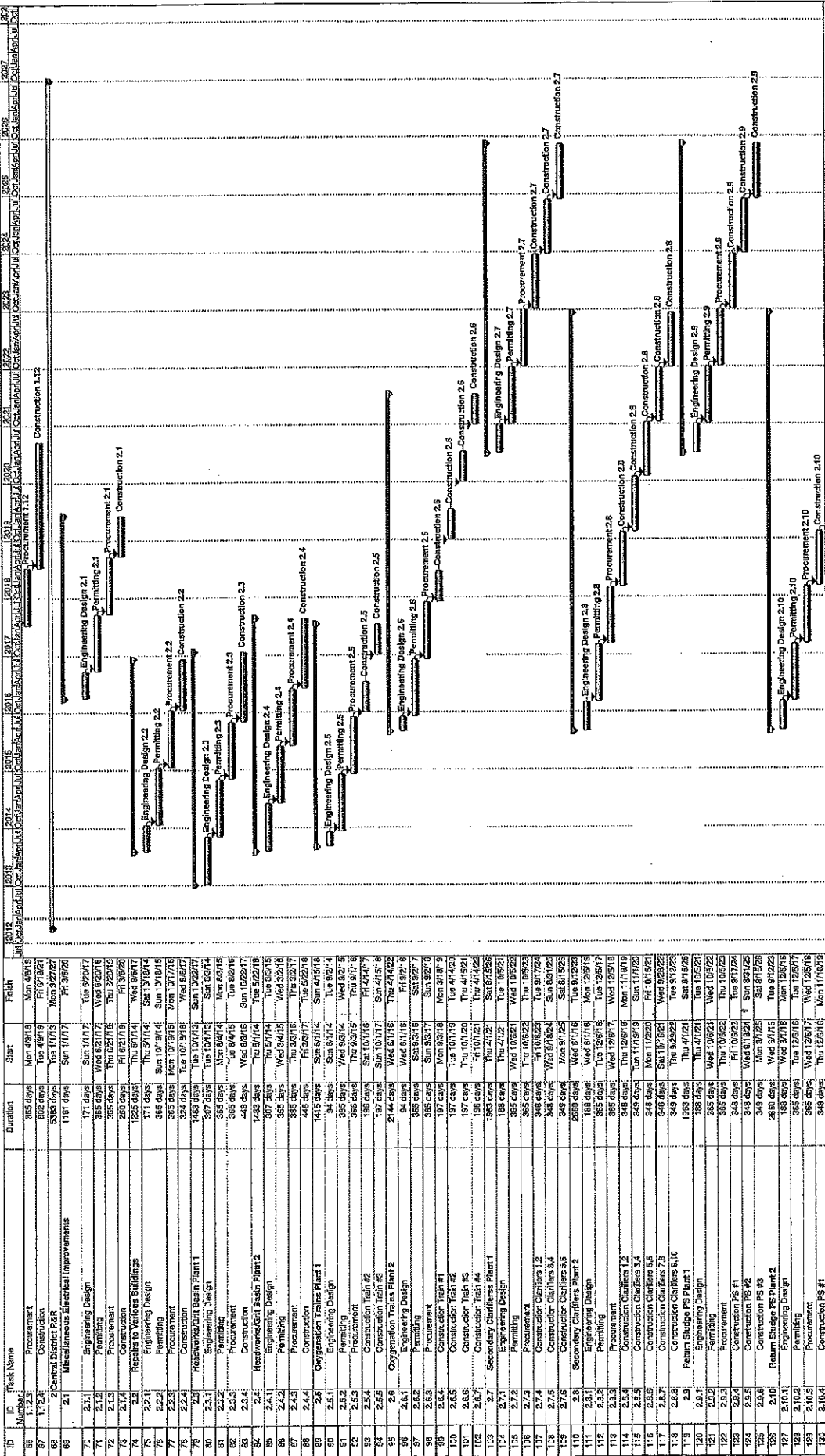

ID	Task Name	Start	Finish	Duration	Progress	Milestones	Summary	External Tasks	External Milestones	Deadlines
66	Procurement	Mon 4/9/12	Mon 4/9/12	365 days	100%	◆	Procurement			
67	Construction	Tue 4/10/12	Mon 3/27/17	212 days	100%	◆	Construction			
68	Permitting	Tue 4/10/12	Mon 3/27/17	212 days	100%	◆	Permitting			
69	Miscellaneous Electrical Improvements	Sun 1/1/17	Fri 3/6/20	1181 days	0%					
70	Engineering Design	Sun 1/1/17	Tue 6/20/17	171 days	100%	◆	Engineering Design			
71	Permitting	Wed 6/27/17	Wed 6/27/17	365 days	100%	◆	Permitting			
72	Construction	Thu 6/27/18	Thu 6/27/18	365 days	100%	◆	Construction			
73	Procurement	Thu 6/27/18	Thu 6/27/18	365 days	100%	◆	Procurement			
74	Engineering Design	Wed 5/6/17	Wed 5/6/17	1225 days	100%	◆	Engineering Design			
75	Permitting	Thu 5/17/14	Sat 10/18/14	171 days	100%	◆	Permitting			
76	Construction	Sun 10/18/14	Sun 10/18/14	365 days	100%	◆	Construction			
77	Procurement	Mon 10/18/14	Mon 10/17/16	365 days	100%	◆	Procurement			
78	Engineering Design	Tue 10/17/13	Wed 6/6/17	1463 days	100%	◆	Engineering Design			
79	Construction	Tue 10/17/13	Sun 10/22/17	1463 days	100%	◆	Construction			
80	Permitting	Mon 8/24/14	Mon 8/24/14	365 days	100%	◆	Permitting			
81	Procurement	Tue 8/24/16	Tue 8/24/16	365 days	100%	◆	Procurement			
82	Construction	Wed 8/24/16	Sun 10/22/17	448 days	100%	◆	Construction			
83	Engineering Design	Thu 9/17/14	Tue 5/20/18	1488 days	100%	◆	Engineering Design			
84	Permitting	Wed 8/24/16	Wed 8/24/16	365 days	100%	◆	Permitting			
85	Construction	Thu 9/17/17	Tue 5/22/17	307 days	100%	◆	Construction			
86	Procurement	Thu 9/17/17	Thu 9/17/17	365 days	100%	◆	Procurement			
87	Engineering Design	Thu 9/17/17	Thu 9/17/17	48 days	100%	◆	Engineering Design			
88	Permitting	Sun 8/17/14	Sun 8/17/14	119 days	100%	◆	Permitting			
89	Construction	Sat 8/9/15	Sun 8/9/15	365 days	100%	◆	Construction			
90	Procurement	Mon 8/24/16	Mon 8/24/16	365 days	100%	◆	Procurement			
91	Engineering Design	Wed 8/24/16	Wed 8/24/16	48 days	100%	◆	Engineering Design			
92	Permitting	Thu 9/17/14	Tue 5/20/18	1488 days	100%	◆	Permitting			
93	Construction	Thu 9/17/14	Sun 8/9/15	365 days	100%	◆	Construction			
94	Procurement	Mon 8/24/16	Mon 8/24/16	365 days	100%	◆	Procurement			
95	Engineering Design	Wed 8/24/16	Wed 8/24/16	48 days	100%	◆	Engineering Design			
96	Permitting	Thu 9/17/14	Tue 5/20/18	1488 days	100%	◆	Permitting			
97	Construction	Thu 9/17/14	Sun 8/9/15	365 days	100%	◆	Construction			
98	Procurement	Mon 8/24/16	Mon 8/24/16	365 days	100%	◆	Procurement			
99	Engineering Design	Wed 8/24/16	Wed 8/24/16	48 days	100%	◆	Engineering Design			
100	Permitting	Thu 9/17/14	Tue 5/20/18	1488 days	100%	◆	Permitting			
101	Construction	Thu 9/17/14	Sun 8/9/15	365 days	100%	◆	Construction			
102	Procurement	Mon 8/24/16	Mon 8/24/16	365 days	100%	◆	Procurement			
103	Engineering Design	Wed 8/24/16	Wed 8/24/16	48 days	100%	◆	Engineering Design			
104	Permitting	Thu 9/17/14	Tue 5/20/18	1488 days	100%	◆	Permitting			
105	Construction	Thu 9/17/14	Sun 8/9/15	365 days	100%	◆	Construction			
106	Procurement	Mon 8/24/16	Mon 8/24/16	365 days	100%	◆	Procurement			
107	Engineering Design	Wed 8/24/16	Wed 8/24/16	48 days	100%	◆	Engineering Design			
108	Permitting	Thu 9/17/14	Tue 5/20/18	1488 days	100%	◆	Permitting			
109	Construction	Thu 9/17/14	Sun 8/9/15	365 days	100%	◆	Construction			
110	Procurement	Mon 8/24/16	Mon 8/24/16	365 days	100%	◆	Procurement			
111	Engineering Design	Wed 8/24/16	Wed 8/24/16	48 days	100%	◆	Engineering Design			
112	Permitting	Thu 9/17/14	Tue 5/20/18	1488 days	100%	◆	Permitting			
113	Construction	Thu 9/17/14	Sun 8/9/15	365 days	100%	◆	Construction			
114	Procurement	Mon 8/24/16	Mon 8/24/16	365 days	100%	◆	Procurement			
115	Engineering Design	Wed 8/24/16	Wed 8/24/16	48 days	100%	◆	Engineering Design			
116	Permitting	Thu 9/17/14	Tue 5/20/18	1488 days	100%	◆	Permitting			
117	Construction	Thu 9/17/14	Sun 8/9/15	365 days	100%	◆	Construction			
118	Procurement	Mon 8/24/16	Mon 8/24/16	365 days	100%	◆	Procurement			
119	Engineering Design	Wed 8/24/16	Wed 8/24/16	48 days	100%	◆	Engineering Design			
120	Permitting	Thu 9/17/14	Tue 5/20/18	1488 days	100%	◆	Permitting			
121	Construction	Thu 9/17/14	Sun 8/9/15	365 days	100%	◆	Construction			
122	Procurement	Mon 8/24/16	Mon 8/24/16	365 days	100%	◆	Procurement			
123	Engineering Design	Wed 8/24/16	Wed 8/24/16	48 days	100%	◆	Engineering Design			
124	Permitting	Thu 9/17/14	Tue 5/20/18	1488 days	100%	◆	Permitting			
125	Construction	Thu 9/17/14	Sun 8/9/15	365 days	100%	◆	Construction			
126	Procurement	Mon 8/24/16	Mon 8/24/16	365 days	100%	◆	Procurement			
127	Engineering Design	Wed 8/24/16	Wed 8/24/16	48 days	100%	◆	Engineering Design			
128	Permitting	Thu 9/17/14	Tue 5/20/18	1488 days	100%	◆	Permitting			
129	Construction	Thu 9/17/14	Sun 8/9/15	365 days	100%	◆	Construction			
130	Procurement	Mon 8/24/16	Mon 8/24/16	365 days	100%	◆	Procurement			

ID	Task Name	Duration	Start	Finish
131	2.10.5 Construction PS #2	348 days	Tue 1/19/19	Sun 1/11/20
132	2.10.6 Construction PS #3	348 days	Mon 1/22/19	Fri 1/17/20
133	2.10.7 Construction PS #4	348 days	Wed 9/26/18	Wed 9/26/19
134	2.10.8 Construction PS #5	348 days	Thu 9/27/18	Tue 9/23/19
135	2.11 Entail Pump Station	1225 days	Sun 1/17/17	Sat 5/29/20
136	2.11.1 Engineering Design	171 days	Sun 1/17/17	Tue 5/20/17
137	2.11.2 Permitting	365 days	Wed 6/21/17	Wed 6/20/18
138	2.11.3 Procurement	365 days	Thu 6/21/18	Thu 5/20/19
139	2.11.4 Construction	324 days	Fri 6/21/18	Sat 5/20/20
140	2.12 Gravy Sludge Thickener Plant 1	1464 days	Sat 4/17/17	Fri 4/22/21
141	2.12.1 Engineering Design	188 days	Sat 4/17/17	Thu 1/10/17
142	2.12.2 Permitting	365 days	Fri 1/10/17	Fri 1/10/17
143	2.12.3 Procurement	365 days	Sat 1/10/18	Sat 1/10/18
144	2.12.4 Construction	566 days	Sun 1/10/18	Fri 4/26/21
145	2.13 Gravy Sludge Thickener Plant 2	1484 days	Thu 1/11/18	Wed 1/20/21
146	2.13.1 Engineering Design	188 days	Thu 1/11/18	Tue 4/25/18
147	2.13.2 Permitting	365 days	Wed 4/26/18	Wed 4/26/17
148	2.13.3 Procurement	365 days	Thu 4/26/18	Thu 4/26/18
149	2.13.4 Construction	568 days	Fri 4/26/18	Wed 1/23/19
150	2.14 Digesters Plant 1	2080 days	Fri 9/29/18	Mon 1/29/26
151	2.14.1 Civil 1	1510 days	Fri 9/29/18	Thu 8/26/24
152	2.14.1.1 Engineering Design	188 days	Fri 9/29/18	Wed 1/14/21
153	2.14.1.2 Permitting	365 days	Thu 1/14/21	Thu 1/14/21
154	2.14.1.3 Procurement	365 days	Fri 1/14/21	Fri 1/14/21
155	2.14.1.4 Construction	592 days	Wed 1/14/21	Tue 9/1/26
156	2.14.2 Civil 2	1413 days	Wed 1/14/21	Mon 1/13/29
157	2.14.2.1 Engineering Design	183 days	Wed 1/14/21	Tue 6/22/21
158	2.14.2.2 Permitting	365 days	Thu 6/22/21	Thu 6/22/21
159	2.14.2.3 Procurement	365 days	Wed 6/22/21	Wed 6/22/21
160	2.14.2.4 Construction	593 days	Thu 6/22/21	Wed 1/5/24
161	2.15 Digesters Plant 2	593 days	Thu 6/22/21	Mon 1/19/26
162	2.15.1 Civil 1	1510 days	Thu 10/17/18	Fri 8/19/22
163	2.15.1.1 Engineering Design	188 days	Thu 10/17/18	Sat 11/10/17
164	2.15.1.2 Permitting	365 days	Sun 4/24/19	Sun 4/24/19
165	2.15.1.3 Procurement	365 days	Mon 4/24/19	Mon 4/24/19
166	2.15.1.4 Construction	592 days	Tue 4/24/19	Tue 4/24/19
167	2.15.2 Civil 2	1510 days	Thu 6/14/18	Wed 8/15/17
168	2.15.2.1 Engineering Design	188 days	Fri 6/14/18	Thu 11/4/18
169	2.15.2.2 Permitting	365 days	Thu 11/4/18	Thu 11/4/18
170	2.15.2.3 Procurement	365 days	Fri 11/4/18	Fri 11/4/18
171	2.15.2.4 Construction	592 days	Sat 11/4/17	Tue 6/18/18
172	2.15.3 Civil 3	1510 days	Thu 12/17/18	Mon 1/22/21
173	2.15.3.1 Engineering Design	188 days	Thu 12/17/18	Mon 1/22/21
174	2.15.3.2 Permitting	365 days	Wed 6/27/17	Wed 6/27/18
175	2.15.3.3 Procurement	365 days	Thu 6/27/18	Thu 6/27/18
176	2.15.3.4 Construction	592 days	Fri 6/27/18	Mon 1/22/21
177	2.15.4 Civil 4	1511 days	Sun 7/1/18	Fri 8/19/22
178	2.15.4.1 Engineering Design	188 days	Sun 7/1/18	Fri 1/4/19
179	2.15.4.2 Permitting	365 days	Sat 1/4/19	Sat 1/4/19
180	2.15.4.3 Procurement	365 days	Sun 1/4/19	Sun 1/4/19
181	2.15.4.4 Construction	593 days	Mon 1/4/19	Fri 9/15/22
182	2.16 Dewatering Building	1894 days	Wed 6/17/18	Sat 6/7/21
183	2.16.1 Engineering Design	427 days	Wed 6/17/18	Tue 8/17/17
184	2.16.2 Permitting	365 days	Wed 8/21/17	Wed 8/17/18
185	2.16.3 Procurement	365 days	Thu 8/17/18	Thu 8/17/18
186	2.16.4 Construction	737 days	Fri 8/21/18	Sat 6/7/21
187	2.17 Chlorination Facilities	1450 days	Thu 10/17/18	Fri 9/29/17
188	2.17.1 Engineering Design	342 days	Thu 10/17/18	Sun 6/7/17
189	2.17.2 Permitting	365 days	Mon 9/18/17	Mon 9/18/17
190	2.17.3 Procurement	365 days	Tue 9/18/17	Tue 9/18/17
191	2.17.4 Construction	388 days	Wed 9/17/18	Fri 9/29/17
192	2.18 Odor Control Systems	1278 days	Sat 10/17/18	Thu 7/26/20
193	2.18.1 Engineering Design	260 days	Sat 10/17/18	Sat 6/17/17
194	2.18.2 Permitting	365 days	Sun 6/17/18	Sun 6/17/18
195	2.18.3 Procurement	365 days	Mon 6/18/18	Mon 6/17/18
196	2.18.4 Construction	388 days	Tue 6/18/18	Thu 7/26/20

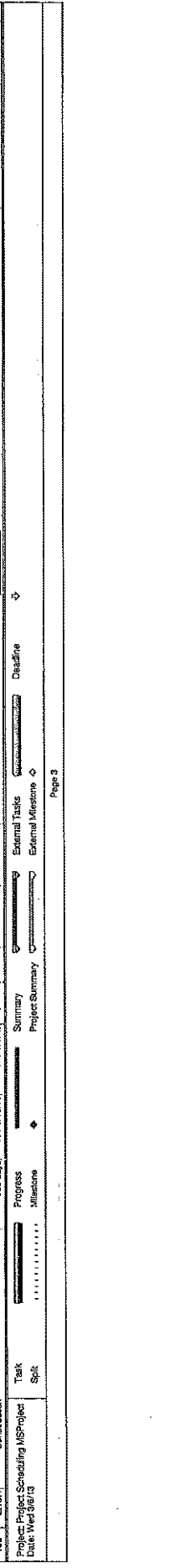

ID	ID	Task Name	Duration	Start	Finish
187	187	Co-Gen Improvements	1785 days	Thu 5/11/14	Sun 3/31/18
188	188	Engineering Design	474 days	Mon 5/17/15	Mon 5/17/15
189	189	Permitting	585 days	Wed 6/16/15	Wed 6/16/17
190	190	Construction	509 days	Wed 6/16/15	Sun 3/21/18
201	201	Station Upgrading Station	311 days	Thu 11/11/16	Fri 6/22/17
202	202	Engineering Design	265 days	Thu 11/11/16	Thu 6/9/17
203	203	Permitting	385 days	Sat 8/10/17	Sat 8/26/17
204	204	Construction	265 days	Sun 8/27/17	Sun 8/27/17
205	205	Procurement	265 days	Mon 8/21/17	Fri 6/22/17
206	206	Pump Station No.1	1118 days	Sat 10/11/16	Wed 10/23/19
207	207	Engineering Design	128 days	Sat 10/11/16	Sun 2/6/17
208	208	Permitting	385 days	Mon 2/6/17	Mon 2/6/17
209	209	Construction	385 days	Tue 2/6/17	Tue 2/6/17
210	210	Procurement	385 days	Tue 2/6/17	Tue 2/6/17
211	211	Construction	385 days	Wed 10/23/19	Wed 10/23/19
212	212	Pump Station No.2	1118 days	Wed 10/11/14	Sun 10/22/17
213	213	Engineering Design	128 days	Wed 10/11/14	Thu 2/5/15
214	214	Permitting	385 days	Thu 2/5/15	Thu 2/5/15
215	215	Procurement	385 days	Sat 2/6/17	Sat 2/6/17
216	216	Construction	265 days	Sun 2/6/17	Sun 10/22/17
217	217	02 Plant Process Controls Phase 2	1295 days	Tue 10/11/13	Tue 3/9/17
218	218	Engineering Design	129 days	Tue 10/11/13	Sun 2/21/17
219	219	Permitting	385 days	Mon 2/21/17	Sun 2/21/17
220	220	Construction	385 days	Tue 2/21/17	Tue 2/21/17
221	221	Procurement	385 days	Wed 2/21/17	Tue 2/21/17
222	222	Station Monitoring and Alarms	385 days	Thu 2/21/17	Tue 2/21/17
223	223	Engineering Design	385 days	Thu 2/21/17	Wed 3/8/17
224	224	Permitting	385 days	Thu 2/21/17	Wed 3/8/17
225	225	Procurement	385 days	Sat 3/4/17	Thu 3/9/17
226	226	Construction	385 days	Sat 3/4/17	Tue 2/27/17
227	227	Verification	189 days	Wed 7/12/17	Wed 7/12/17
228	228	Engineering Design	189 days	Thu 7/20/17	Thu 7/20/17
229	229	Permitting	385 days	Thu 7/20/17	Thu 7/20/17
230	230	Procurement	385 days	Thu 7/20/17	Thu 7/20/17
231	231	Construction	607 days	Sat 7/22/17	Thu 7/20/17
232	232	Rehabilitation of Walkways and Stairways	519 days	Tue 10/1/13	Mon 8/27/17
233	233	Construction	519 days	Tue 10/1/13	Mon 8/27/17
234	234	Oxygen Production	1825 days	Thu 1/1/15	Mon 12/30/19
235	235	Engineering Design	385 days	Thu 1/1/15	Thu 1/23/17
236	236	Permitting	385 days	Thu 1/1/15	Thu 1/23/17
237	237	Procurement	385 days	Sat 12/26/16	Thu 1/23/17
238	238	Construction	730 days	Sun 12/26/16	Mon 12/30/19
239	239	SCADA RTU Upgrades	180 days	Tue 10/1/13	Sat 3/25/14
240	240	Construction	180 days	Tue 10/1/13	Sat 3/25/14
241	241	High Strength Inherent Impact Study	540 days	Tue 1/1/13	Tue 6/24/14
242	242	Engineering Study	540 days	Tue 1/1/13	Tue 6/24/14
243	243	North District Risk	1825 days	Tue 1/1/13	Tue 6/24/14
244	244	Headworks and Sludge Degrinding & Transfer	1825 days	Tue 1/1/13	Sat 4/7/19
245	245	Engineering Design	210 days	Thu 1/1/13	Thu 8/27/13
246	246	Permitting	385 days	Thu 1/1/13	Tue 8/27/13
247	247	Procurement	385 days	Wed 10/1/14	Wed 8/27/13
248	248	Construction Phase 1: Screens	450 days	Thu 1/1/13	Thu 12/28/13
249	249	Construction Phase 2: Building Improvements	500 days	Thu 1/1/13	Sat 4/7/18
250	250	Primary Clarifiers and Odor Control	1896 days	Sun 11/1/15	Sun 4/18/21
251	251	Engineering Design	210 days	Sun 11/1/15	Thu 9/21/16
252	252	Permitting	385 days	Thu 9/21/16	Thu 9/21/16
253	253	Procurement	385 days	Sat 6/24/17	Sat 6/24/17
254	254	Construction	1571 days	Sun 8/21/18	Sun 4/19/21
255	255	Oxygenation Trains	1843 days	Tue 1/1/15	Wed 1/17/24
256	256	Engineering Design	287 days	Tue 1/1/15	Mon 10/14/16
257	257	Permitting	385 days	Wed 10/14/16	Wed 10/19/16
258	258	Procurement	385 days	Wed 10/14/16	Wed 10/19/16
259	259	Construction	287 days	Thu 10/14/16	Wed 10/19/16

Project: Project Scheduling MS/Project Date: Wed 3/6/18

Summary: Summary

External Tasks: External Tasks

Milestone: Milestone

Task: Task

Deadline: Deadline

Page 4

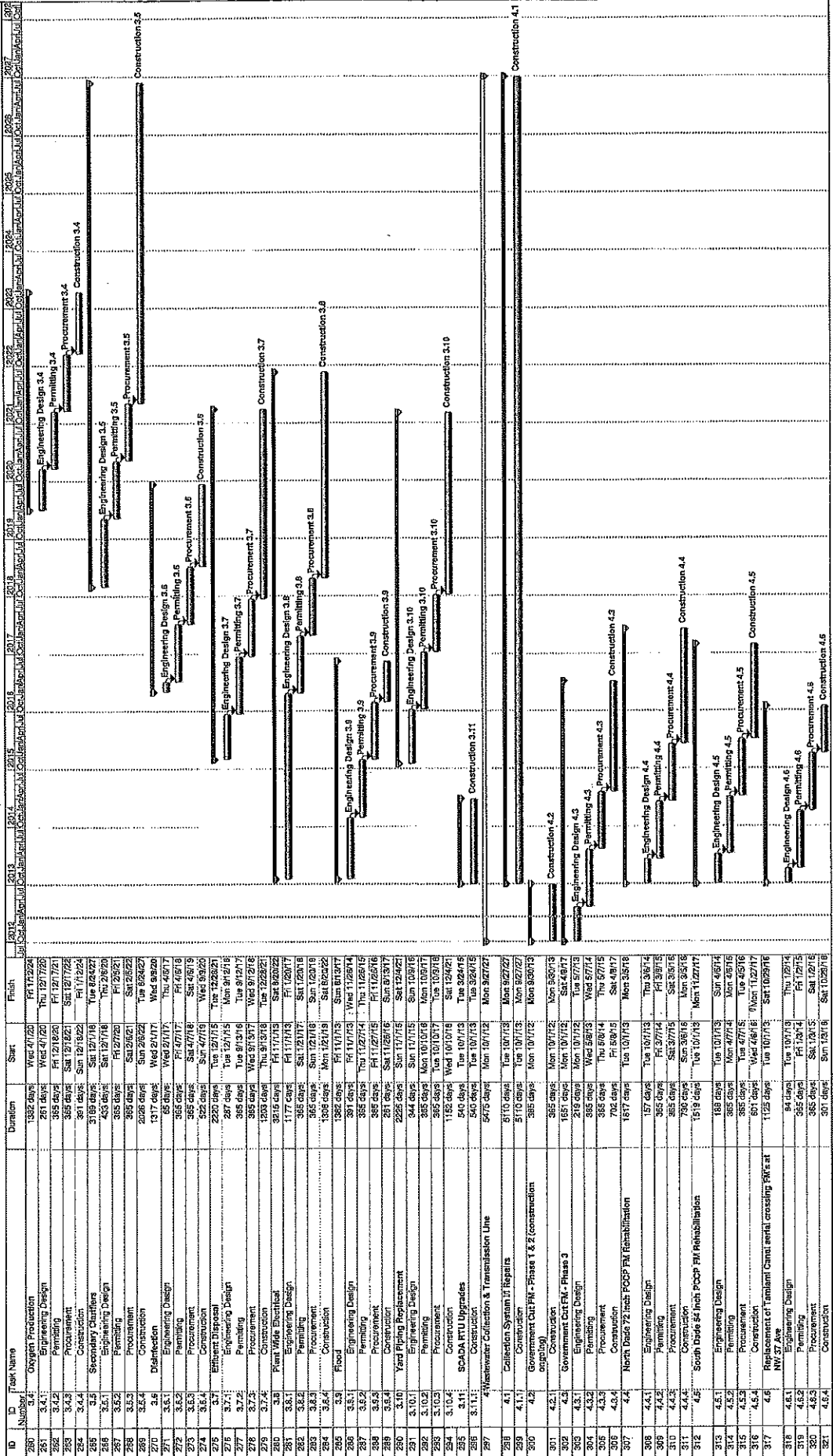

Legend: **Task** (solid bar), **Milestone** (dotted bar), **Summary** (dashed bar), **External Task** (hatched bar), **External Milestone** (dotted bar with diamond), **Deadline** (vertical line)

Project: Project Scheduling (MS) Project
 Date: Wed 9/18/12
 Scale: 1:1
 Page 5

ID	ID Number	Task Name	Duration	Start	Finish	2012	2013	2014	2015	2016	2017	2018	2019	2020	2021	2022	2023	2024	2025	2026	2027
322	4.1	Replacement of 18 inch DP FM in Miami Lakes	1266 days	Fri 11/1/13	Sun 4/29/17																
323	4.1.1	Engineering Design	125 days	Fri 11/1/13	Wed 3/25/14																
324	4.1.2	Permitting	385 days	Thu 3/25/14	Thu 3/25/15																
325	4.1.3	Procurement	385 days	Fri 3/26/14	Fri 3/26/15																
326	4.1.4	Construction	401 days	Sat 3/26/14	Sun 4/26/17																
327	4.3	Rehabilitation of 24 inch PCCP FM in the City of Miami	1269 days	Fri 11/1/13	Sun 4/29/17																
328	4.3.1	Engineering Design	105 days	Fri 11/1/13	Wed 3/25/14																
329	4.3.2	Permitting	385 days	Thu 3/25/14	Thu 3/25/15																
330	4.3.3	Procurement	385 days	Fri 3/26/14	Fri 3/26/15																
331	4.3.4	Construction	401 days	Sat 3/26/14	Sun 4/26/17																
332	4.5	Replace Approximately 30 miles of AC FM Transmission System	2188 days	Fri 11/1/13	Tue 10/8/18																
333	4.5.1	Engineering Design	342 days	Fri 11/1/13	Thu 10/9/14																
334	4.5.2	Permitting	385 days	Fri 10/10/14	Fri 10/9/15																
335	4.5.3	Procurement	385 days	Sat 10/10/14	Sat 10/9/15																
336	4.5.4	Construction	1095 days	Sun 10/9/14	Sun 10/9/18																
337	4.10	Op-Lock Airport 48" PCCP force main replacement	1585 days	Fri 11/1/13	Sun 1/28/18																
338	4.10.1	Engineering Design	270 days	Fri 11/1/13	Mon 7/23/14																
339	4.10.2	Permitting	385 days	Tue 7/23/14	Thu 7/23/15																
340	4.10.3	Procurement	385 days	Wed 7/23/14	Wed 7/23/15																
341	4.10.4	Construction	385 days	Thu 7/23/14	Wed 7/23/15																
342	5	3000 Primary Street System Upgrade of PS20415	2025 days	Mon 11/11/13	Sat 11/24/18																
343	5.1	Engineering Design	185 days	Mon 11/11/13	Sat 11/23/14																
344	5.1.1	Permitting	318 days	Fri 11/1/13	Sat 8/23/14																
345	5.1.2	Procurement	385 days	Sun 8/27/14	Sun 8/25/15																
346	5.1.3	Construction	385 days	Mon 8/27/14	Sun 11/24/18																
347	5.1.4	Construction	302 days	Mon 8/27/14	Sun 11/24/18																
348	5.1	Upgrade of PS20417	1914 days	Fri 11/1/13	Sun 1/27/18																
349	5.1.1	Engineering Design	292 days	Sat 8/23/14	Sat 8/23/14																
350	5.1.2	Permitting	385 days	Sun 8/24/14	Mon 8/24/15																
351	5.1.3	Procurement	385 days	Mon 8/24/14	Mon 8/24/15																
352	5.1.4	Construction	902 days	Tue 8/26/14	Sun 1/27/18																
353	5.3	Upgrade of PS20492	1914 days	Fri 11/1/13	Sun 1/27/18																
354	5.3.1	Engineering Design	292 days	Fri 11/1/13	Sat 8/23/14																
355	5.3.2	Permitting	385 days	Sun 8/24/14	Sun 8/23/15																
356	5.3.3	Procurement	385 days	Mon 8/24/14	Mon 8/24/15																
357	5.3.4	Construction	902 days	Tue 8/26/14	Sun 1/27/18																
358	5.4	Replacement of Switchgear PS20414	1551 days	Fri 11/1/13	Wed 5/26/18																
359	5.4.1	Engineering Design	219 days	Fri 11/1/13	Sat 8/23/14																
360	5.4.2	Permitting	385 days	Sun 8/24/14	Sun 8/23/15																
361	5.4.3	Procurement	385 days	Mon 8/24/14	Mon 8/24/15																
362	5.4.4	Construction	702 days	Tue 8/26/14	Wed 5/26/18																
363	5.5	Replacement of Switchgear and Rehabilitation of Western PS20415	1914 days	Fri 11/1/13	Sun 1/27/18																
364	5.5.1	Engineering Design	292 days	Fri 11/1/13	Sat 8/23/14																
365	5.5.2	Permitting	385 days	Sun 8/24/14	Sun 8/23/15																
366	5.5.3	Procurement	385 days	Mon 8/24/14	Mon 8/24/15																
367	5.5.4	Construction	902 days	Tue 8/26/14	Sun 1/27/18																
368	5.5	Replacement of Switchgear PS20416	1655 days	Fri 11/1/13	Wed 5/26/18																
369	5.6.1	Engineering Design	219 days	Fri 11/1/13	Sat 8/23/14																
370	5.6.2	Permitting	385 days	Sun 8/24/14	Sun 8/23/15																
371	5.6.3	Procurement	385 days	Mon 8/24/14	Mon 8/24/15																
372	5.6.4	Construction	718 days	Tue 8/26/14	Wed 5/26/18																
373	5.7	Replacement of Switchgear and Rehabilitation of Wetwell PS20417	1914 days	Fri 11/1/13	Sun 1/27/18																
374	5.7.1	Engineering Design	292 days	Fri 11/1/13	Sat 8/23/14																
375	5.7.2	Permitting	385 days	Sun 8/24/14	Sun 8/23/15																
376	5.7.3	Procurement	385 days	Mon 8/24/14	Mon 8/24/15																
377	5.7.4	Construction	902 days	Tue 8/26/14	Sun 1/27/18																
378	5.8	Replacement of Electrical and Mechanical Equipment in PS2010	1914 days	Fri 11/1/13	Sun 1/27/18																
379	5.8.1	Engineering Design	292 days	Fri 11/1/13	Sat 8/23/14																
380	5.8.2	Permitting	385 days	Sun 8/24/14	Sun 8/23/15																

Project Summary
External Milestone
External Tasks
External Milestone
Summary
Project Summary
Progress
Milestone
Task
Epk
Deadline

Exhibit D-2 Capital Work Plan with Milestones revised March 8, 2013

ID	Number	Task Name	Duration	Start	Finish
381	5.1.1	Procurement	385 days	Mon 8/17/15	Mon 8/8/16
382	5.1.2	Construction	622 days	Tue 8/9/16	Sun 12/13/17
383	5.1.3	Procurement of Pump and Electrical Equipment at PS&S001	1851 days	Fri 11/11/13	Wed 8/6/16
384	5.1.4	Engineering Design	219 days	Fri 11/11/13	Sat 6/7/14
385	5.1.5	Permitting	385 days	Sun 8/6/14	Sun 6/7/15
386	5.1.6	Procurement	385 days	Mon 8/6/16	Mon 8/6/16
387	5.1.7	Construction	702 days	Tue 6/7/16	Wed 8/9/18
388	5.1.8	Upgrade of PS&S088	1851 days	Fri 11/11/13	Wed 8/9/18
389	5.1.9	Engineering Design	219 days	Fri 11/11/13	Sat 6/7/14
390	5.1.10	Permitting	385 days	Sun 8/6/14	Sun 6/7/15
391	5.1.11	Procurement	385 days	Mon 8/6/16	Mon 8/6/16
392	5.1.12	Construction	702 days	Tue 6/7/16	Wed 8/9/18
393	5.1.13	Installation of 80 inch FM from Kombal Dr to PS&S056	1851 days	Fri 11/11/13	Wed 8/9/18
394	5.1.14	Engineering Design	219 days	Fri 11/11/13	Sat 6/7/14
395	5.1.15	Permitting	385 days	Sun 8/6/14	Sun 6/7/15
396	5.1.16	Procurement	385 days	Mon 8/6/16	Mon 8/6/16
397	5.1.17	Construction	702 days	Tue 6/7/16	Wed 8/9/18
398	5.1.18	Replacement of Switchgear at PS&S017	1851 days	Fri 11/11/13	Wed 8/9/18
399	5.1.19	Engineering Design	219 days	Fri 11/11/13	Sat 6/7/14
400	5.1.20	Permitting	385 days	Sun 8/6/14	Sun 6/7/15
401	5.1.21	Procurement	385 days	Mon 8/6/16	Mon 8/6/16
402	5.1.22	Construction	702 days	Tue 6/7/16	Wed 8/9/18
403	5.1.23	Rehabilit Emergency Generators and Controls at Regional Pumpstations	993 days	Fri 11/11/13	Wed 7/20/16
404	5.1.24	Engineering Design	83 days	Fri 11/11/13	Thu 12/2/14
405	5.1.25	Permitting	385 days	Fri 12/1/14	Fri 12/1/15
406	5.1.26	Procurement	385 days	Sat 12/1/15	Sat 12/1/16
407	5.1.27	Construction	270 days	Wed 12/2/16	Wed 12/2/16
408	5.1.28	Upgrade of PS&S 0085, 0452	483 days	Mon 10/8/15	Wed 8/9/18
409	5.1.29	Procurement	385 days	Mon 10/8/15	Sat 6/7/16
410	5.1.30	Construction	270 days	Tue 12/8/15	Thu 12/8/15
411	5.1.31	Upgrade of PS&S 0085, 0201, 0343, 0374, 0387	703 days	Wed 12/8/15	Thu 12/8/15
412	5.1.32	Engineering Design	150 days	Wed 7/17/14	Thu 7/10/14
413	5.1.33	Permitting	90 days	Thu 7/10/14	Wed 10/8/14
414	5.1.34	Procurement	180 days	Mon 10/8/14	Mon 4/6/15
415	5.1.35	Construction	270 days	Mon 4/6/15	Thu 12/8/15
416	5.1.36	Upgrade of PS&S 0190, 0437, 0468, 0580	703 days	Fri 12/1/15	Sat 12/8/16
417	5.1.37	Engineering Design	180 days	Fri 12/1/15	Sat 7/11/15
418	5.1.38	Permitting	90 days	Sat 7/11/15	Fri 10/9/15
419	5.1.39	Procurement	180 days	Wed 4/6/15	Wed 4/6/15
420	5.1.40	Construction	270 days	Wed 4/6/15	Sat 12/8/16
421	5.1.41	Upgrade of PS&S 0087, 0351, 0370, 0403	730 days	Sat 12/1/15	Sun 12/8/17
422	5.1.42	Engineering Design	180 days	Sat 12/1/15	Sun 7/10/15
423	5.1.43	Permitting	90 days	Sat 12/8/16	Sat 12/8/16
424	5.1.44	Procurement	180 days	Sat 12/8/16	Thu 4/6/17
425	5.1.45	Construction	270 days	Thu 4/6/17	Sun 12/8/17
426	5.1.46	Upgrade of PS&S 0441, 0487, 0710, 0827, 0852, 1206	730 days	Sun 11/1/17	Mon 12/8/18
427	5.1.47	Engineering Design	180 days	Sun 11/1/17	Mon 7/10/17
428	5.1.48	Permitting	90 days	Mon 7/10/17	Sun 10/9/17
429	5.1.49	Procurement	180 days	Sun 10/9/17	Fri 4/6/18
430	5.1.50	Construction	270 days	Fri 4/6/18	Mon 12/8/18
431	5.1.51	SCADA/RTU Upgrades	900 days	Tue 10/1/13	Fri 3/9/16
432	5.1.52	Construction	900 days	Tue 10/1/13	Fri 3/9/16

Project: Project Scheduling MIS/Project
 Date: Wed 9/6/13

Task: Split

Progress: Milestones

Summary: Project Summary

External Tasks: External Milestones

Deadline: Deadline

Page 7

APPENDIX E

Appendix E

Supplemental Environmental Project Plan

This Appendix E describes the Supplemental Environmental Project (“SEP”) to be performed and funded by Miami-Dade as required by the Consent Decree. Miami-Dade shall install at least seven thousand six hundred sixty (7,660) linear feet of Gravity Sewer Mains within an industrial area which currently has no access to sanitary sewers and relies on septic systems. Disconnecting the industrial users from septic tanks and connecting them to the sewer system will improve water quality in the aquifer and nearby surface waters, and prevent future contamination. Miami-Dade County estimates that the SEP will cost two million forty seven thousand two hundred dollars (\$2,047,200.00), and commits to spend at least this amount to complete the SEP. No part of this SEP expenditure shall include federal or state funds, including federal or state low interest loans, contracts, or grants.

SEP Overview:

Miami-Dade has identified an area in the County which is zoned business, commercial, and industrial, from light to heavy manufacturing where there currently is no access to sewers, and where septic systems are inadequate or failing and many businesses pre-date the current septic system regulations. The area is bounded on the West by Northwest 37th Ave, on the North by State Road 112, on the East by Northwest 27th Ave, and on the South by North River Drive, which is parallel to the Miami River. The Melrose Neighborhood Revitalization Strategy Area is within these boundaries. The area is a low-income and high-poverty area. The attached map shows the project area, the sewer lines that are proposed to serve the area, and the higher risk (County permitted) businesses that will gain access to sewers as a result of this project.

The SEP shall include the installation of at least seven thousand six hundred and sixty (7,660) linear feet of Gravity Sewer Mains within the area described above. The installation will also include public laterals up to the property line. Pursuant to existing regulations, businesses will have ninety (90) days to abandon their septic systems and connect to the public laterals.

The priority of the connections will be based on proximity to the existing Gravity Sewer Mains. As the Gravity Sewer Mains which will be constructed through this SEP are being constructed as extensions from existing Gravity Sewer Mains, the businesses that are located closer to the existing Gravity Sewer Mains will be able to connect first, as the extended Gravity Sewer Mains near them are completed. The sequencing of construction will be determined as part of the design process based upon field conditions and construction efficiency. However, within those constraints, highest priority will be assigned to the western-most system which will serve the largest number of facilities which predate, and do not meet, current septic tank regulations, thence moving progressively to the eastern systems. It is estimated that the Gravity Sewer Mains will service a minimum of seventy-four (74) existing businesses. Miami-Dade estimates that an estimated flow of seventeen thousand six hundred (17,600) gallons per day of wastewater will be removed from the existing septic tanks and will be treated at one of Miami-Dade's WWTPs instead.

Once Miami-Dade constructs the Gravity Sewer Mains, Miami-Dade will use existing authority to ensure that all developed lots in the affected area are connected to the new sewer extensions pursuant to sections 32-79, 32-80, and 24-43.1 (7) of the Code of Miami-Dade County.

SEP Budget

Miami-Dade estimates that it will cost two million forty seven thousand two hundred dollars (\$2,047,200) to construct the proposed Gravity Sewer Mains. This amount includes the installation of gravity sewer lines and public laterals up to the property line, including project planning, design, permitting, procurement, construction cost, and construction management. The amount does not include the cost of installation of private laterals on the businesses' properties or the one-time connection fee, both of which are the private businesses' responsibility. Nor does it include the business' cost of abandoning the septic systems. Businesses which qualify for an exemption from water and sewer connection charges will be eligible to apply for a refund of connection charge. The exemption is available for commercial or industrial businesses which are located in a designated enterprise zone such as the targeted area, and which have a minimum of twenty-five percent (25%) of their employees residing in the enterprise zone, which has been identified as an environmental justice area. SEP funds shall not be used to pay connection charge refunds.

Eligible SEP costs are: planning, design, permitting, procurement, construction cost for the gravity lines and public laterals, and construction management. Construction management shall be limited to less than ten percent (10%) of the total budget. SEP funds shall not be used for Miami-Dade administrative expenses.

Project Processing:

Miami-Dade will use a streamlined project approach to enhance implementation, while providing appropriate management oversight. The process shall include:

1. Miami-Dade will identify the facilities with the highest risk of causing contamination.

2. The goal of the system design will be to maximize sewer system access to the highest risk properties within the area with the available funding.
3. The project will include: designing the lines, obtaining permits, installing the gravity lines and public laterals, inspecting the gravity lines and public laterals, and providing construction management.
4. The design milestone for this project shall be completed within thirty-six (36) months of the Date of Entry of the Consent Decree. Substantial completion of project construction shall be completed within sixty (60) months of the Date of Entry.
5. The SEP Completion Report will include information showing that Miami-Dade has finished construction of the Gravity Sewer Mains and is taking appropriate actions, including enforcement activity, to ensure that the businesses in the affected areas abandon their septic systems and connect to the sewer system.



Description

Proposed Sewer Improvements to serve properties with Industrial Waste permits adjacent to impaired water bodies.

MDWASD Service Area between NW 37 Ave and NW 27 Ave from State Road 112 to NW 26 Street on the South and C-6 Miami Canal on the Southwest.

Legend

- Industrial Waste (IW) Permits
- IW > 500 GPD
- ▲ Existing Pump Station
- Existing Force Main
- Existing Gravity Main
- Proposed Priority Gravity Main
- Basin 86
- BU-1 - Neighborhood Business District
- BU-1A - Limited Business District
- BU-2 - Special Business District
- BU-3 - Liberal Business District
- C-2 - Liberal Commercial
- GU - Government Use
- IL-1 - Industrial-Light Manufacturing District
- IL-2 - Industrial Heavy Manufacturing District

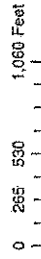

C-6 Miami Canal - Sewer Improvements

Supplemental Environmental Project

Date: 11/01/2012

WATER AND SEWER DEPARTMENT

