

Department of  
Transportation and Public  
Works



## **Safe Route to Schools Locations Phase 21**

### **FMs 439894-1**

Flagami Elementary, 920 SW 76<sup>th</sup> Ave., Miami, FL 33144; Carrie P. Meek Westview K-8 Center, 2101 NW 127<sup>th</sup> St., Miami, FL 33167; Shadowlawn Elementary, 149 NW 49<sup>th</sup> St., Miami, FL 33127; Hubert O. Sibley K-8 Center, 255 SW 115<sup>th</sup> St., Miami, FL 33168

Miami-Dade County

Supplemental Solicitation  
and Contract Documents

**Disadvantaged Business Enterprise Program:**

Contractor shall comply with DBE Requirements

**Community Workforce Program:**

Not Applicable

**DTPW Capital Improvements Engineer:**

Laura Hernandez

**RPQ Issue Date:**

12/15/2022

## TABLE OF CONTENTS

---

SECTION 1:	INVITATION TO BID
SECTION 2:	SOLICITATION FORMS
	BID FORM
	ATTACHMENT 5A
	ACKNOWLEDGMENT OF ADDENDA
	SURETY BID BOND FORM
	DISADVANTAGED BUSINESS ENTREPRISE (DBE)-INFO
	CERTIFICATION OF INCLUSION OF FHWA-1273
	LAP CERTIFICATION OF CURRENT CAPACITY
	CERTIFICATION REGARDING DEBARMENT, SUSPENSION, INELIGIBILITY AND VOLUNTARY EXCLUSION
	CERTIFICATION FOR DISCLOSURE OF LOBBYING ACTIVITIES ON FEDERAL-AID CONTRACTS
	DISCLOSURE OF LOBBYING ACTIVITIES
	COLLUSION AFFIDAVIT
	AFFIRMATION OF VENDOR AFFIDAVITS
SECTION 3:	SUPPLEMENTARY INSTRUCTION TO BIDDERS
SECTION 4:	SUPPLEMENTAL INFORMATION
	SAMPLE SURETY PERFORMANCE AND PAYMENT BOND
SECTION 5:	SUPPLEMENTARY CONDITIONS
SECTION 6:	SPECIFICATIONS
	DTPW DIVISION 1 SPECIFICATIONS (GENERAL REQUIREMENTS)
	CONSTRUCTION SPECIFICATIONS
SECTION 7:	SPECIAL PROVISIONS
SECTION 8:	ENGINEERING DRAWINGS

## **SECTION 1: INVITATION TO BID**

# INVITATION TO BID

**Department of Transportation and  
Public Works**  
Capital Improvements Division  
111 NW 1st Street, Suite 1410  
Miami Fl. 33128



**MIAMI-DADE COUNTY, FLORIDA**  
**REQUEST FOR PRICE QUOTATION (RPQ)**  
Contract No: MCC 7360 Plan - CICC 7360-0/08  
RPQ No: 20220029

**INVITATION TO BID**

A RPQ has been issued for the work identified below. If you are interested in submitting a bid for this project, please submit your bid via Sealed Envelopes, attention to Clerk of the Board Office at 111 N.W. First Street, Suite 1710 no later than 1/18/2023 at 02:00 PM. If you have any questions, contact Felix Hernandez at 305-679-0038.

This RPQ is issued under the terms and conditions of the Miscellaneous Construction Contracts (MCC) Program MCC 7360 Plan.

**RPQ DETAILED BREAKDOWN**

Bid Due Date:	1/18/2023	Time Due:	02:00 PM	Submitted Via:	Sealed Envelopes	SBE-Con. Level:	N/A
Estimated Value:	\$382,770 (excluding Contingencies and Dedicated Allowances)						
Project Name:	Safe Route to Schools Locations Phase 21 FM 439894-1						
Project Location:	Flagami, Carrie Meek, Shadowlawn, Hubert Elementar						
License Requirements:	Primary:	Electrical Contractor; General Engineering					
	Sub:	Concrete Engineering; Parking Strip Painting; Pavement Marking; Painting					
Scope of Work:	(Contractor must obtain and submit all permits prior to performing any work). Work under this contract includes but is not limited to providing the supervision, labor, required materials, equipment, tools, operations and documentation for installing pedestrian signals head and push button detection at existing signalized intersections, electrical power service assemblies, school speed zone signs and flashing beacons, school crosswalk signs, pavement markings, sidewalks, curb and gutter, pedestrian ramps, and other related tasks pursuant to the requirements of the Contract Documents.						
Document Pickup:	Contact:	Capital Improvements Division	Phone No:	305-375-2930	Date:	12/15/2022	
	Location:	111 NW 1st Street Suite 1410, Miami Fl. 33128					
Pre-Bid Meeting::	YES	Mandatory:	No	Date:	1/5/2023	Time:	10:00 AM
	Location:	Virtual					
Site Meeting:	No	Mandatory:	No	Date:		Time:	
	Location:						
Bid shall be submitted to:	Contact:	Clerk of the Board Office					
	Address:	111 N.W. First Street, Suite 1710					
	Email:	clerkbcc@miamidade.gov	FAX # :	305-375-2931			
Type of Contract:	Multiple Trade			Method of Award:	Lowest Responsible Bidder		
Method of Payment:	Scheduled Monthly Payments			Insurance Required:	YES		
Additional Insurance Required:	YES		If Yes - Minimum Coverage:		\$1,000,000.00		
Performance & Payment Bond Required:	YES			Bid Bond Required:	YES		
Prevailing Wage Rate Required:	N/A	Davis Bacon:	YES	Maintenance Wages:	NO	AIPP:	NO
				Amount:			
SBE-Con. Requirements:	NO	Percentage:	0.00%	SBD Certificate of Assurance Form Required:	NO		
DBE Participation:	NO	Percentage:	0.00%	DBE Subcontractor Forms Required:	YES		
CWP Requirements:	NO	Percentage:	0.00%				
SBE-S Requirements	NO	Percentage:	0.00%				
SBE-G Requirements	NO	Percentage:	0.00%				
Liquidated Damages:	YES	\$\$ Per Day:	\$1,694.00				
Trade Set-a-side:	NO	If Yes, Trade =					
For RPQ's less than \$10,000, if no LD rate is specified, the County reserves the right to assess actual damages in lieu of LDs.							
Design Drawing Included:	YES	Shop Drawing Included:	NO	Specifications Included:	YES		

Anticipated Start Date: 6/12/2023 | Calendar Days for Project Completion: 365

Comments: This project is subject to the criteria and conditions of federal funded projects.

Location of Work  
The locations for work to be performed under the terms of this Contract are listed at the following Schools located in Miami-Dade County:

1. FLAGAMI ELEMENTARY, 920 SW 76 AVE. Miami FL 33144
2. CARRIE P. MEEK WEST VIEW K-8 CENTER, 2101 NW 127 ST. Miami, FL 33167
3. SHADOWLAWN ELEMENTARY, 149 NW 49 ST. Miami, FL 33127
4. HUBERT O. SIBLEY K-8 CENTER, 255 NW 115 ST. Miami, FL 33168

Contractors Qualification Requirements:

1. Pursuant to the requirements of Section 10-3 of the Code of Miami-Dade County, Florida and these Solicitation and Contract Documents, the Bidder must hold a valid, current, and active:
  - a. Certificate of Competency from the County's Construction Trades Qualifying Board as an Electrical Contractor or a General Engineering Contractor or as a Specialty Engineering Contractor, commensurate to the requirements of the Scope of Work, in one or more engineering crafts to include paving engineering or concrete-work engineering contractor, The specialty contractor shall subcontract with a qualified contractor any work which is incidental to the specialty but is specified in the aforementioned Code as being the work of other than that of the Engineering Specialty for which certified; or
  - b. Certification, as an electrical contractor provided by the State of Florida Electrical Contractors' Licensing Board, pursuant to the provisions of Section 489.511 of the Florida Statutes (F.S.). or;
2. Pursuant to Section 255.20, F.S. and in lieu of the above, the County may consider a bid from a Bidder that is a duly licensed Contractor in good standing that has been prequalified and considered eligible by the Florida Department of Transportation (FDOT) under Section 337.14, F.S. and Chapter 14-2, Florida Administrative Code, to perform the work described in the Contract Documents. Contractors seeking consideration under this Paragraph shall submit along with the Bid Documents for review and consideration, current copy(ies) of their FDOT Certificate(s) of Qualification, Certification of Work Underway, and Status of Contract(s) On Hand. Acceptable FDOT prequalification(s) necessary to perform the Work specified in the Contract Documents include the Traffic Signal Work Class.

Disadvantaged Business Enterprise (DBE)  
The Contractor shall comply with the requirements pursuant to 49 Code of Federal Regulations (CFR) Part 26 as implemented by the approved FDOT DBE Program.

Identification and Insurance Requirements.

A. To the extent provided by law, Contractor shall indemnify, defend, and hold harmless the County and the State of Florida, Department of Transportation, including FDOT officers, agents, and employees, against any actions, claims, or damages arising out of, relating to, or resulting from negligent or wrongful act(s) of the Contractor, or any of its officers, agents, or employees, acting within the scope of their office or employment, in connection with the rights granted to or exercised by the Contractor, hereunder, to the extent and within the limitations of Section 768.28, Florida Statutes.

B. The foregoing indemnification shall not constitute a waiver of sovereign immunity beyond the limits set forth in Florida Statutes, Section 768.28. Nor shall the same be construed to constitute agreement by the Contractor to indemnify the County for the negligent acts or omissions of the County, its officers, agents, or employees, or third parties. Nor shall the same be construed to constitute agreement by the Contractor to indemnify FDOT for the negligent acts or omissions of FDOT officers, agents, or employees, or third parties. This indemnification shall survive the termination of this Agreement.

C. This indemnification shall survive the termination of this Agreement. Nothing contained in this paragraph is intended to nor shall it constitute a waiver of the State of Florida and the County sovereign immunity.

D. The Contractor shall furnish the Department of Transportation and Public Works, 111 NW 1st Street, Miami Florida 33128, Certificate(s) of Insurance which indicate that insurance coverage has been obtained which meets the requirements as outlined below:

1. Worker compensation insurance for all employees as required by Florida Statute 440.
2. Commercial General Liability in an amount not less than \$1,000,000 per occurrence

\$2,000,000 aggregate. Coverage to include products/completed operations and XCU. Miami Dade County shall be included as additional insured.

3. Automobile Liability covering all owned, non-owned and hired vehicles in an amount not less than \$1,000,000 combined single limit.

4. Umbrella or excess liability insurance in an amount not less than \$3,000,000 per occurrence \$3,000,000 aggregate.

All insurance policies required above shall be issued by companies authorized to do business under the laws of the State of Florida, with the following qualifications:

1. The company must be rated no less than A as to management, and no less than Class VII as to financial strength, by Best Insurance Guide, published by A.M. Best Company, Oldwick, New Jersey, or its equivalent, subject to the approval of the County Risk Management Division. or;

2. The company must hold a valid Florida Certificate of Authority as shown in the latest List of All Insurance Companies Authorized or Approved to Do Business in Florida issued by the State of Florida Department of Financial Services.

**Bid Documents:**

Bidding documents may be purchased from the Miami-Dade County Department of Transportation and Public Works, Capital Improvements Division, 111 NW 1st Street, 14th Floor, Miami, Florida 33128 for a non-refundable fee of One Hundred dollars (\$100.00) per each complete set of documents. Payment shall be in the form of a company check, cashier's check, or money order payable to the Miami-Dade County, Department of Transportation and Public Works. Documents can also be downloaded for free at <https://www.miamidade.gov/apps/isd/StratProc/Home/CurrentSolicitations>

**Award of Contract:**

The award of the Contract, shall be to the lowest responsive and responsible bidder whose bid complies with all of the material terms of this solicitation and is determined to be in the best interest of the County.

**Addendums - RFI'S**

All RFI requests should be e-mailed to [Laura.Hernandez@miamidade.gov](mailto:Laura.Hernandez@miamidade.gov) while copying the Clerk of the Board.

Solicitation Documents, Addendums, RFI's, and the document holders list (bidder's list) are available to view online at the following web address:

<https://www.miamidade.gov/apps/isd/StratProc/Home/CurrentSolicitations>

All document holders must provide an e-mail address. The Department will only be sending addendums and RFI by e-mail and posting online at the aforementioned link. The bidder's list will be updated every Friday during the advertisement phase of the contract. Please be aware that acknowledgment of receipt of all addendums and RFI remain a requirement when submitting bids.

**Vendor Registration:**

Due to the new Vendor Registration procedures of the Internal Services Department, Procurement management Division, updated definitions along with the Affirmation of Vendor Affidavit has been added to the Bid Submittal Package. The successful bidder must be registered under this new procedure prior to award.

**PRE BID & BID SUBMITTAL DUE DATE:**

Due to the current situation with the COVID-19, DTPW is conducting virtual no mandatory pre-bid meetings.

**Pre-Bid Meeting Conference Time & Location:**

Conference date and time: Wednesday, January 5, 2023, 10:00 AM.

Virtual Meeting: Phone Number to Call: +1 415 655 0001

Access Code: 2315 276 4499

**Bid Submittal Time and Location:** Wednesday, January 18, 2023, 2:00 PM, at 111 NW 1st Street, 17th Floor, Clerk of the Board Office.

**Bid Opening** immediately after Bid Submittal in the 18th floor.

**Anticipate Award Date:** March 6, 2023

## **SECTION 2: SOLICITATION FORMS**

All forms and documents contained in this Section shall be completed pursuant to these Contract Documents and submitted with the Bid Submittal for this Project.



# BID FORM

# Bid Form

**PROJECT TITLE:** Safe Route to Schools Locations Phase 21 FM 439894-1

**PROJECT NO:** 20220029

IF THIS PROPOSAL IS ACCEPTED, THE UNDERSIGNED AGREES TO COMPLETE ALL WORK UNDER THIS CONTRACT WITHIN THREE HUNDRED SIXTY FIVE (365) CALENDAR DAYS AFTER THE EFFECTIVE DATE ESTABLISHED IN THE "NOTICE TO PROCEED WITH CONTRACT WORK".

Item No	Quantity	Unit	Description	Written Unit Amount	Unit Price	Total
101-1-A	1.0	L.S.	Mobilization			
102-1A	1.0	L.S.	MAINTENANCE OF TRAFFIC			
104-18	16.0	EA.	Inlet Protection System			
110-1-1	1.0	L.S.	CLEARING AND GRUBBING (Includes removal of existing pavement, sidewalks, driveways, drainage structures and pipes, vegetation, miscellaneous concrete. Also includes tree removal, cherry hedge removal, miscellaneous earthwork and saw cutting)			
110-4-10	164.0	S.F.	REMOVE AND DISPOSE OF EXISTING CURB AND GUTTER, SIDEWALKS INCLUDING RAMPS AND MISCELLANEOUS CONCRETE IN AREAS NOT INCLUDED IN THE CLEARING AND GRUBBING ITEM			
110-7-1A	6.0	EA.	Install new mail box			
200-2-1	354.0	S.Y.	BASE PREPARATION FOR NEW SIDEWALK CONSTRUCTION			
422-6-1F	6.0	EA.	ADJUST WATER METER BOX - Single or Dual Services			
520-2A	507.0	L.F.	CONCRETE CURB AND/OR GUTTER (Any type, Including base preparation)			
522-1-1	2,336.0	S.Y.	CONCRETE SIDEWALK (4" thick) Category 1			
522-2-3	1,052.0	S.Y.	CONCRETE SIDEWALK (6" thick) Category 1			
527-2	696.0	S.F.	DETECTABLE WARNING ON WALKING SURFACE			

CSCCRP\_PROJECT\_BID\_ITEMS

02/18/2022 11:11 AM

Bidder must fill-in completely the next page for the bid to be valid.

Page 1 of 4

# Bid Form

**PROJECT TITLE:** Safe Route to Schools Locations Phase 21 FM 439894-1

**PROJECT NO:** 20220029

IF THIS PROPOSAL IS ACCEPTED, THE UNDERSIGNED AGREES TO COMPLETE ALL WORK UNDER THIS CONTRACT WITHIN THREE HUNDRED SIXTY FIVE (365) CALENDAR DAYS AFTER THE EFFECTIVE DATE ESTABLISHED IN THE \*NOTICE TO PROCEED WITH CONTRACT WORK\*.

Item No	Quantity	Unit	Description	Written Unit Amount	Unit Price	Total
570-1-2	164.0	S.Y.	PERFORMCE TURF (Sodding)			
580-3	820.0	L.F.	Tree protection barricades			
580-322-2A	3.0	EA.	TREE REMOVAL AND DISPOSAL (6" to 12" Dia.)			
635-2-11	1.0	EA.	PULL & SPLICE BOX, Furnish & Install, 13" x 24" COVER SIZE			
700-40-01	53.0	AS.	ROADSIDE SIGNS {(SINGLE POST ) (LESS THAN 12 S.F.)}			
700-46-01	9.0	AS.	REMOVAL OF SIGN AND POST			
700-48-18	99.0	EA.	SIGN PANEL (LESS THAN 15 SF.)			
700-48-60B	20.0	EA.	REMOVAL OF SIGN PANEL			
706-1-12	268.0	EA.	REFLECTIVE PAVEMENT MARKERS (class B, mono or bi-directional, all colors)			
711-7	6,480.0	S.F.	REMOVE EXISTING PAVEMENT MARKINGS			
711-11-121	597.0	L.F.	THERMOPLASTIC (White) (Solid) (6")			
711-11-123	4,295.0	L.F.	THERMOPLASTIC (White) (Solid) (12")			

# Bid Form

**PROJECT TITLE:** Safe Route to Schools Locations Phase 21 FM 439894-1

**PROJECT NO:** 20220029

IF THIS PROPOSAL IS ACCEPTED, THE UNDERSIGNED AGREES TO COMPLETE ALL WORK UNDER THIS CONTRACT WITHIN THREE HUNDRED SIXTY FIVE (365) CALENDAR DAYS AFTER THE EFFECTIVE DATE ESTABLISHED IN THE \*NOTICE TO PROCEED WITH CONTRACT WORK\*.

Item No	Quantity	Unit	Description	Written Unit Amount	Unit Price	Total
711-11-125	2,564.0	L.F.	THERMOPLASTIC (White) (Solid) (24")			
711-11-221	4,508.0	L.F.	THERMOPLASTIC (Yellow) (Solid) (6")			

**Total:** \_\_\_\_\_

The bidder understands and agrees that the above total is inclusive of all work necessary to complete the job as described in the plans and specifications.

Quantities are established and are included only for the purpose of facilitating the uniform comparison of bids submitted. The County shall not be held responsible if the quantities are not accurate and all computations for compensation shall be based upon the actual work performed, whether greater or less than estimated quantities.

Tax Identification Number: \_\_\_\_\_

D.C. Certificate of competency No: \_\_\_\_\_

Bidder's Name: \_\_\_\_\_

Bidder's telephone Number: \_\_\_\_\_

Bidder's address: \_\_\_\_\_

# Bid Form

**PROJECT TITLE:** Safe Route to Schools Locations Phase 21 FM 439894-1

**PROJECT NO:** 20220029

IF THIS PROPOSAL IS ACCEPTED, THE UNDERSIGNED AGREES TO COMPLETE ALL WORK UNDER THIS CONTRACT WITHIN THREE HUNDRED SIXTY FIVE (365) CALENDAR DAYS AFTER THE EFFECTIVE DATE ESTABLISHED IN THE \*NOTICE TO PROCEED WITH CONTRACT WORK\*.

BIDDER ACKNOWLEDGES THAT INCLUDED IN THE VARIOUS ITEMS OF THE PROPOSAL AND IN THE TOTAL BID PRICE ARE COSTS FOR COMPLYING WITH THE FLORIDA TRENCH SAFETY ACT (90-96), LAWS OF FLA. EFFECTIVE OCTOBER 1st, 1990. THE BIDDER FURTHER IDENTIFIES THE COSTS TO BE SUMMARIZED BELOW:

	Trench Safety Measure (Description)	Units of Measure (LF, SY)	Unit (Quantity)	Unit Cost	Extended Cost
A.	_____	_____	_____	_____	_____
B.	_____	_____	_____	_____	_____
C.	_____	_____	_____	_____	_____
D.	_____	_____	_____	_____	_____

FAILURE TO COMPLETE THE ABOVE MAY RESULT IN THE BID BEING DECLARED NON-RESPONSIVE

ATTACHMENT 5A

Department of  
Transportation and Public  
Works  
Capital Improvements Division  
111 NW 1st Street, Suite 1410  
Miami, 33128



MIAMI-DADE COUNTY, FLORIDA  
REQUEST FOR PRICE QUOTATION (RPQ)  
Contract No: MCC 7360 Plan - CICC  
7360-0/08 RPQ No: 20220029

**RPQ BID FORM – ATTACHMENT 5A**

---

**RPQ Project Name:** Safe Route to Schools Locations Phase 21 FM 439894-1

---

**Price Proposal** (Cost to Perform the work **must** be stated here. State 'No Bid' if not submitting a price proposal)

---

**Bidder's Company Name:** \_\_\_\_\_

**Company Address:** \_\_\_\_\_

**City:** \_\_\_\_\_ **State:** \_\_\_\_\_ **Zip:** \_\_\_\_\_

**Telephone No:** \_\_\_\_\_ **Fax No:** \_\_\_\_\_ **E-Mail:** \_\_\_\_\_

THE EXECUTION OF THIS FORM CONSTITUTES THE UNEQUIVOCAL OFFER OF PROPOSER TO BE BOUND BY THE TERMS OF ITS PROPOSAL. FAILURE TO SIGN THIS SOLICITATION WHERE INDICATED BELOW BY AN AUTHORIZED REPRESENTATIVE SHALL RENDER THE PROPOSAL NON-RESPONSIVE. THE COUNTY MAY, HOWEVER, IN ITS SOLE DISCRETION, ACCEPT ANY PROPOSAL THAT INCLUDES AN EXECUTED DOCUMENT WHICH UNEQUIVOCALLY BINDS THE PROPOSER TO THE TERMS OF ITS OFFER.

**Name of Person Submitting Quote (Print):** \_\_\_\_\_

**Number of Addendums received:** \_\_\_\_\_ (if none' write "None")

**Signature:** \_\_\_\_\_ **Date:** \_\_\_\_\_

---

**Note:** Quotes must be submitted on this form. Quote envelope must state RPQ Number, date and time due and the Bidder's Name. Use of any other form for submission of the price quotation shall result in the rejection of the price quotation. Late bids will not be opened. *Low bidder will be notified, in the Recommendation of Award, of the requirements to submit current copies of insurance certificates in accordance with the Contract Documents. By signature, the CONTRACTOR agrees to be bound by the terms set forth in the MCC 7360 Plan.*

## ACKNOWLEDGEMENT OF ADDENDA



MIAMI-DADE COUNTY  
DEPARTMENT OF TRANSPORTATION AND PUBLIC WORKS (DTPW)

---

PROJECT: Safe Routes to Schools Locations, Phase 21, FM 439894-1  
Project No. 20220029

**ACKNOWLEDGEMENT OF ADDENDA**

(Must be completed and submitted with required solicitation documents)

**Instructions:** Complete Part I or Part II, as applicable.

---

**PART I:** Listed below are the dates of issue for each Addendum received in connection with this solicitation.

Addendum #1, Dated _____,	202__
Addendum #2, Dated _____,	202__
Addendum #3, Dated _____,	202__
Addendum #4, Dated _____,	202__
Addendum #5, Dated _____,	202__
Addendum #6, Dated _____,	202__
Addendum #7, Dated _____,	202__
Addendum #8, Dated _____,	202__
Addendum #9, Dated _____,	202__
Addendum #10, Dated _____,	202__

---

**PART II:**

\_\_\_\_ No Addendum was received in connection with this solicitation.

---

Authorized Signature: \_\_\_\_\_ Date: \_\_\_\_\_

Print Name: \_\_\_\_\_ Title: \_\_\_\_\_

Firm Name: \_\_\_\_\_

# SURETY BID BOND FORM

PRINCIPAL (Full legal name and business address)	TYPE OF ORGANIZATION ("X" one)	
	<input type="checkbox"/> Individual	<input type="checkbox"/> Partnership
	<input type="checkbox"/> Joint Venture	<input type="checkbox"/> Corporation

SURETY (Name and business address)

PENAL SUM OF BOND	*****Five Percent of the Total amount Bid*****		
BID IDENTIFICATION	Project No:	20220029	Bid Opening Date:
	County Project Name:	Safe Route to Schools Locations, Phase 21, FM 439894-1	

**OBLIGATION**

Principal and Surety, jointly and severally, bind themselves, their heirs, executors, administrators, successors, and assigns to pay to Miami-Dade County, Florida (herein after County) upon default of Principal the penal sum set forth on the face of this Bond.

Principal and Surety agree that the Penal Sum of the Bond is a liquidated damage reasonably estimated to compensate the County for damages suffered as a result of the Principal's default including but not limited to any resulting from delay, reprourement costs and incremental costs of contracting.

Default of Principal shall occur in the event that the Principal withdraws Bid within 180 days after bid opening (or any extension thereof agreed to in writing by the Bidder and County); or, after proper notification of intent to Contract from the County, fails to comply with all pre-award requirements including, but not limited to providing Payment and Performance Bonds with good and sufficient surety and the necessary Insurance Certificates pursuant to the Contract Documents, and enter into a written Contract with the County, as may be required; all within 10 days after the prescribed forms are presented to Principal for signature or as otherwise required by the Bidding Documents.

Payment under this Bond will be due and payable upon default of Principal and within 30 calendar days after receipt by Principal and Surety of written notice of default from County, which notice will be given with reasonable promptness, identifying this Bond and the Project.

Surety shall cause to be attached to this Bond a current and effective Power of Attorney evidencing the authority of the officer, agent, or representative who executed this Bond on behalf of Surety to execute, seal, and deliver such Bond and bind the Surety thereby.

**CONDITIONS**

The Principal has submitted the Bid identified above.

**THEREFORE**

By executing this instrument Surety agrees that its obligation is not impaired by any extension(s) of the time for acceptance of the bid that the Principal may grant to the County. Notice to the Surety of extensions is waived. However, waiver of the notice applies only to extensions aggregating not more than 60 calendar days in addition to the period originally allowed for acceptance of the bid. Any changes in or under the Contract Documents and compliance or noncompliance with any formalities connected with the Contract or the changes does not affect Surety's obligation under this Bond.

**WITNESS**

The Principal and Surety executed this Bond and affixed their seals on the above date. Copy of Authorized Agent's current Identification Card as issued by State of Florida Insurance Commissioner must be attached.

**PRINCIPAL**

SIGNATURE		Principal's Corporate Seal
NAME AND TITLE (Typed)		

**SURETY**

SIGNATURE OF ATTORNEY-IN-FACT		Surety's Corporate Seal
PRINTED NAME OF ATTORNEY-IN-FACT (Typed)		
SIGNATURE OF AUTHORIZED FLORIDA AGENT		
PRINTED NAME OF AUTHORIZED FLORIDA AGENT (Typed)		

DISADVANTAGED BUSINESS ENTREPRISE (DBE)  
PACKAGE INFORMATION

### **DBE Utilization**

The Department began its DBE race neutral program January 1, 2000. **Contract specific goals are not placed on Federal/State contracts;** however, the Department has an overall 10.65% DBE goal it must achieve. In order to assist contractors in determining their DBE commitment level, the Department has reviewed the estimates for this letting.

As you prepare your bid, please monitor potential or anticipated DBE utilization for contracts. When the low bidder executes the contract with the Department, information will be requested of the contractor's DBE participation for the project. While the utilization is not mandatory in order to be awarded the project, continuing utilization of DBE firms on contracts supports the success of Florida's DBE Program, and supports contractors' Equal Employment Opportunity and DBE Affirmative Action Programs.

Any project listed as 0% DBE availability does not mean that a DBE may not be used on that project. A 0% DBE availability may have been established due to any of the following reasons: limited identified subcontracting opportunities, minimal contract days, and/or small contract dollar amount. Contractors are encouraged to identify any opportunities to subcontract to DBE's.

Please contact the Equal Opportunity Office at (850) 414-4747 if you have any questions regarding this information.

### **DBE Reporting**

If you are the prime contractor on a project, enter your DBE participation in the Equal Opportunity Compliance system prior to the pre-construction or pre-work conference for all federal and state funded projects. This **will not** become a mandatory part of the contract. It will assist the Department in tracking and reporting planned or estimated DBE utilization. During the contract, the prime contractor is required to report actual payments to DBE and MBE subcontractors through the web-based Equal Opportunity Compliance (EOC) system.

All DBE payments must be reported whether or not you initially planned to utilize the company. In order for our race neutral DBE Program to be successful, your cooperation is imperative. If you have any questions, please contact EOOHelp@dot.state.fl.us.

### **Bid Opportunity List**

The Federal DBE Program requires States to maintain a database of all firms that are participating or attempting to participate on FDOT-assisted contracts. The list must include all firms that bid on prime contracts or bid or quote subcontracts on FDOT-assisted projects, including both **DBE's and non-DBEs**.

Please complete the Bidders Opportunity List through the Equal Opportunity Compliance system within 3 business days of submission of the bid or proposal for ALL subcontractors or sub-consultants who quoted to you for specific project for this letting. The web address to the Equal Opportunity Compliance system is: <https://www.fdot.gov/equalopportunity/eoc.shtm>.

### **DBE/AA Plans**

Contractors bidding on FDOT contracts are to have an approved DBE Affirmative Action Plan (FDOT Form 275-030-11B) on file with the FDOT Equal Opportunity Office before execution of a contract. DBE/AA Plans must be received with the contractors bid or received by the Equal Opportunity Office prior to the award of the contract.

Plans are approved by the Equal Opportunity Office in accordance with Ch. 14-78, Florida Administrative Code. Plans that do not meet these mandatory requirements may not be approved. Approvals are for a (3) three year period and should be updated at anytime there is a change in the company's DBE Liaison Officer and/or President. Contractors may evidence adoption of the DBE/AA Policy and Plan and/or a change in the designated DBE Liaison officer as follows:

- Print the first page of the document on company stationery ("letterhead") that indicates the company's name, mailing address, phone number, etc.
- Print the company's name in the "\_\_\_\_" space; next to "Date" print the month/day/year the policy is being signed; record the signature of the company's Chief Executive Officer, President or Chairperson in the space next to "by" and print the full first and last name and position title of the official signing the policy.
- Print the DBE Liaison's full name, email address, business mailing address and phone number the bottom of email.

E-mail the completed and signed DBE AA Plan to: **eeoforms@dot.state.fl.us**.

The Department will review the policy, update department records and issue a notification of approval or disapproval; a copy of the submitted plan will not be returned to the contractor.

STATE OF FLORIDA DEPARTMENT OF TRANSPORTATION  
**BID OPPORTUNITY LIST FOR PROFESSIONAL CONSULTANT  
SERVICES, AND COMMODITIES & CONTRACTUAL SERVICES**

375-040-62  
PROCUREMENT  
04/07

Prime Contractor/Prime Consultant: \_\_\_\_\_

Address/Phone Number: \_\_\_\_\_

Procurement Number/Advertisement Number: \_\_\_\_\_

49 CFR Part 26.11 The list is intended to be a listing of all firms that are participating, or attempting to participate, on DOT-assisted contracts. The list must include all firms that bid on prime contracts, or bid or quote subcontracts and supplies materials on DOT-assisted projects, including both DBEs and non-DBEs. For consulting companies this list must include all subconsultants contacting you and expressing an interest in teaming with you on a specific DOT-assisted project. Prime contractors and consultants must provide information for Numbers 1, 2, 3 and 4, and should provide any information they have available on Numbers 5, 6, 7, and 8 for themselves, and their subcontractors and subconsultants.

1. Federal Tax ID Number: \_\_\_\_\_  
2. Firm Name: \_\_\_\_\_  
3. Phone: \_\_\_\_\_  
4. Address: \_\_\_\_\_  
\_\_\_\_\_  
\_\_\_\_\_  
5. Year Firm Established: \_\_\_\_\_

6.  DBE  
 Non-DBE  
7.  Subcontractor  
 Subconsultant

8. Annual Gross Receipts  
 Less than \$1 million  
 Between \$1 - \$5 million  
 Between \$5 - \$10 million  
 Between \$10 - \$15 million  
 More than \$15 million

1. Federal Tax ID Number: \_\_\_\_\_  
2. Firm Name: \_\_\_\_\_  
3. Phone: \_\_\_\_\_  
4. Address: \_\_\_\_\_  
\_\_\_\_\_  
\_\_\_\_\_  
5. Year Firm Established: \_\_\_\_\_

6.  DBE  
 Non-DBE  
7.  Subcontractor  
 Subconsultant

8. Annual Gross Receipts  
 Less than \$1 million  
 Between \$1 - \$5 million  
 Between \$5 - \$10 million  
 Between \$10 - \$15 million  
 More than \$15 million

1. Federal Tax ID Number: \_\_\_\_\_  
2. Firm Name: \_\_\_\_\_  
3. Phone: \_\_\_\_\_  
4. Address: \_\_\_\_\_  
\_\_\_\_\_  
\_\_\_\_\_  
5. Year Firm Established: \_\_\_\_\_

6.  DBE  
 Non-DBE  
7.  Subcontractor  
 Subconsultant

8. Annual Gross Receipts  
 Less than \$1 million  
 Between \$1 - \$5 million  
 Between \$5 - \$10 million  
 Between \$10 - \$15 million  
 More than \$15 million

1. Federal Tax ID Number: \_\_\_\_\_  
2. Firm Name: \_\_\_\_\_  
3. Phone: \_\_\_\_\_  
4. Address: \_\_\_\_\_  
\_\_\_\_\_  
\_\_\_\_\_  
5. Year Firm Established: \_\_\_\_\_

6.  DBE  
 Non-DBE  
7.  Subcontractor  
 Subconsultant

8. Annual Gross Receipts  
 Less than \$1 million  
 Between \$1 - \$5 million  
 Between \$5 - \$10 million  
 Between \$10 - \$15 million  
 More than \$15 million

**AS APPLICABLE, PLEASE SUBMIT THIS FORM WITH YOUR:**

**BID SHEET (Invitation to Bid – ITB)  
LETTERS OF RESPONSE (LOR)  
PRICE PROPOSAL (Request for Proposal – RFP)  
REPLY (Invitation to Negotiate – ITN)**

CERTIFICATION OF INCLUSION OF FHWA-1273



# Certification of Inclusion of FHWA-1273

<b>Project Identification</b>		
1. Project No.	2. FDOT Financial Project No.	3. Project Location
4. Prime Contractor's Name		5. FEID Number
<b>Prime Contractor Certification</b>		
<p>I certify by my signature below that I have included in the contract with the Sub-Contractor, Supplier, or Rental Company identified below, a complete and unaltered copy of FHWA-1273 (Required Contract Provisions Federal-Aid Construction Contracts), and further require inclusion of the same in every lower tier subcontract or purchase order that may be made in turn. I hereby acknowledge my responsibility for ensuring compliance by any subcontractor or lower tier subcontractor with these Required Contract Provisions.</p>		
6. Name (first/last) of Corporate Official signing Certification		7. Title
8. Signature of Certifying Official		9. Date of Signature
<b>Sub-Contractor, Supplier, or Rental Company Certification</b>		
<p>I certify by my signature below that I have received a complete and unaltered copy of FHWA-1273 (Required Contract Provisions Federal-Aid Construction Contracts), will comply with all requirements stipulated therein, and will require inclusion of the same in every lower tier subcontract or purchase order that may be made in turn.</p>		
10. Tier Level		
11. Name of Sub-Contractor, Supplier, or Rental Company Certification:		
12. Name (first/last) of Corporate Official signing Certification		13. Title
14. Signature of Certifying Official		15. Date of Signature
<b>Lower Tier Sub-Contractor, Supplier, or Rental Company Certification</b>		
<p>I certify by my signature below that I have received a complete and unaltered copy of FHWA-1273 (Required Contract Provisions Federal-Aid Construction Contracts) and will comply with all requirements stipulated therein.</p>		
16. Tier Level		
17. Name of Lower Tier Sub-Contractor, Supplier, or Rental Company Certification:		
18. Name (first/last) of Corporate Official signing Certification		19. Title
20. Signature of Certifying Official		21. Date of Signature

## LAP CERTIFICATION OF CURRENT CAPACITY

STATE OF FLORIDA DEPARTMENT OF TRANSPORTATION  
**LAP CERTIFICATION OF CURRENT CAPACITY**

CONFIDENTIAL

For bids to be received on \_\_\_\_\_  
(Letting Date)

Fill in your FDOT Vendor Number VF _____ (Only applicable to FDOT pre-qualified contractors)
--

CERTIFICATE

I hereby certify that the amount of any proposal submitted by this bidder for the above letting does not exceed the amount of the Firm's CURRENT CAPACITY (maximum capacity rating less total uncompleted work).

The total uncompleted work as shown on  
the "Status of Contracts on Hand" report (page 2) \$ \_\_\_\_\_

I further certify that the "Status of Contracts on Hand" report (page 2) was prepared as follows:

1. If the letting is before the 25<sup>th</sup> day of the month, the certificate and report reflect the uncompleted work as of the 15<sup>th</sup> day of the month, last preceding the month of the letting.
2. If the letting is after the 25<sup>th</sup> day of the month, the certificate and report reflects the uncompleted work in progress as of the 15<sup>th</sup> day of the month of the letting.
3. All new contracts (and subcontracts) awarded earlier than five days before the letting date are included in the report and charged against our total rating.

I certify that the information above is correct.

Sworn to and subscribed this \_\_\_\_\_ day  
of \_\_\_\_\_, 20 \_\_\_\_\_

\_\_\_\_\_  
NAME OF FIRM  
By: \_\_\_\_\_  
\_\_\_\_\_  
Title

**STATUS OF CONTRACTS ON HAND**

(Furnish complete information about all your contracts, whether prime or subcontracts; whether in progress or awarded, but not yet begun; and regardless of whom contracted with.)

1	2	3	4	5		6
PROJECTS OWNER, LOCATION AND DESCRIPTION	CONTRACT (OR SUBCONTRACT) AMOUNT	AMOUNT SUBLET TO OTHERS	BALANCE OF CONTRACT AMOUNT	UNCOMPLETED AMOUNT TO BE DONE BY YOU		
				AS PRIME CONTRACTOR	AS SUBCONTRACTOR	
NOTE: Columns 2 and 3 to show total contract (or subcontract) amounts. Column 4 to be difference between columns 2 and 3. Amount in columns 5 or 6 to be uncompleted portion of amount in column 4. All amounts to be shown to nearest \$100. The Contractor may consolidate and list as a single item all contracts which, individually, do not exceed 3% of total, and which, in the aggregate, amount to less than 20% of the total.			TOTALS	\$0.00	\$0.00	
			TOTAL UNCOMPLETED WORK ON HAND TO BE DONE BY YOU (TOTAL COLUMNS 5 AND 6)	\$0.00		

CERTIFICATION REGARDING DEBARMENT, SUSPENSION,  
INELIGIBILITY AND VOLUNTARY EXCLUSION

**CERTIFICATION REGARDING DEBARMENT, SUSPENSION,  
INELIGIBILITY AND VOLUNTARY EXCLUSION-  
LOWER TIER COVERED TRANSACTIONS FOR FEDERAL AID CONTRACTS  
(Compliance with 2 CFR Parts 180 and 1200)**

It is certified that neither the below identified firm nor its principals are presently suspended, proposed for debarment, declared ineligible, or voluntarily excluded from participation in this transaction by any federal department or agency.

Name of Consultant/Contractor: \_\_\_\_\_

By: \_\_\_\_\_

Date: \_\_\_\_\_

Title: \_\_\_\_\_

Instructions for Certification

Instructions for Certification - Lower Tier Participants:

(Applicable to all subcontracts, purchase orders and other lower tier transactions requiring prior FHWA approval or estimated to cost \$25,000 or more - 2 CFR Parts 180 and 1200)

- a. By signing and submitting this proposal, the prospective lower tier is providing the certification set out below.
- b. The certification in this clause is a material representation of fact upon which reliance was placed when this transaction was entered into. If it is later determined that the prospective lower tier participant knowingly rendered an erroneous certification, in addition to other remedies available to the Federal Government, the department, or agency with which this transaction originated may pursue available remedies, including suspension and/or debarment.
- c. The prospective lower tier participant shall provide immediate written notice to the person to which this proposal is submitted if at any time the prospective lower tier participant learns that its certification was erroneous by reason of changed circumstances.
- d. The terms "covered transaction," "debarred," "suspended," "ineligible," "participant," "person," "principal," and "voluntarily excluded," as used in this clause, are defined in 2 CFR Parts 180 and 1200. You may contact the person to which this proposal is submitted for assistance in obtaining a copy of those regulations. "First Tier Covered Transactions" refers to any covered transaction between a grantee or subgrantee of Federal funds and a participant (such as the prime or general contract). "Lower Tier Covered Transactions" refers to any covered transaction under a First Tier Covered Transaction (such as subcontracts). "First Tier Participant" refers to the participant who has entered into a covered transaction with a grantee or subgrantee of Federal funds (such as the prime or general contractor). "Lower Tier Participant" refers any participant who has entered into a covered transaction with a First Tier Participant or other Lower Tier Participants (such as subcontractors and suppliers).
- e. The prospective lower tier participant agrees by submitting this proposal that, should the proposed covered transaction be entered into, it shall not knowingly enter into any lower tier covered transaction with a person who is debarred, suspended, declared ineligible, or voluntarily excluded from participation in this covered transaction, unless authorized by the department or agency with which this transaction originated.
- f. The prospective lower tier participant further agrees by submitting this proposal that it will include this clause titled "Certification Regarding Debarment, Suspension, Ineligibility and Voluntary Exclusion-Lower Tier Covered Transaction," without modification, in all lower tier covered transactions and in all solicitations for lower tier covered transactions exceeding the \$25,000 threshold.
- g. A participant in a covered transaction may rely upon a certification of a prospective participant in a lower tier covered transaction that is not debarred, suspended, ineligible, or voluntarily excluded from the covered transaction, unless it knows that the certification is erroneous. A participant is responsible for ensuring that its principals are not suspended, debarred, or otherwise ineligible to participate in covered transactions. To verify the eligibility of its principals, as well as the eligibility of any lower tier prospective participants, each participant may, but is not required to, check the Excluded Parties List System website (<https://www.epls.gov/>), which is compiled by the General Services Administration.
- h. Nothing contained in the foregoing shall be construed to require establishment of a system of records in order to render in good faith the certification required by this clause. The knowledge and information of participant is not required to exceed that which is normally possessed by a prudent person in the ordinary course of business dealings.
- i. Except for transactions authorized under paragraph e of these instructions, if a participant in a covered transaction knowingly enters into a lower tier covered transaction with a person who is suspended, debarred, ineligible, or voluntarily excluded from participation in this transaction, in addition to other remedies available to the Federal Government, the department or agency with which this transaction originated may pursue available remedies, including suspension and/or debarment.

CERTIFICATION FOR DISCLOSURE OF LOBBYING ACTIVITIES  
ON FEDERAL-AID CONTRACTS

STATE OF FLORIDA DEPARTMENT OF TRANSPORTATION  
**CERTIFICATION FOR DISCLOSURE OF LOBBYING ACTIVITIES  
ON FEDERAL-AID CONTRACTS  
(Compliance with 49CFR, Section 20.100 (b))**

375-030-33  
PROCUREMENT  
10/01

The prospective participant certifies, by signing this certification, that to the best of his or her knowledge and belief:

(1) No federal appropriated funds have been paid or will be paid, by or on behalf of the undersigned, to any person for influencing or attempting to influence an officer or employee of any federal agency, a Member of Congress, an officer or employee of Congress, or an employee of a Member of Congress in connection with the awarding of any federal contract, the making of any federal grant, the making of any federal loan, the entering into of any cooperative agreement, and the extension, continuation, renewal, amendment, or modification of any federal contract, grant, loan, or cooperative agreement.

(2) If any funds other than federal appropriated funds have been paid or will be paid to any person for influencing or attempting to influence an officer or employee of any federal agency, a Member of Congress, an officer or employee of Congress, or an employee of a Member of Congress in connection with this federal contract, grant, loan, or cooperative agreement, the undersigned shall complete and submit Standard Form-LLL, "Disclosure of Lobbying Activities", in accordance with its instructions. (Standard Form-LLL can be obtained from the Florida Department of Transportation's Professional Services Administrator or Procurement Office.)

This certification is a material representation of fact upon which reliance was placed when this transaction was made or entered into. Submission of this certification is a prerequisite for making or entering into this transaction imposed by Section 1352, Title 31, U.S. Code. Any person who fails to file the required certification shall be subject to a civil penalty of not less than \$10,000 and not more than \$100,000 for each such failure.

The prospective participant also agrees by submitting his or her proposal that he or she shall require that the language of this certification be included in all lower tier subcontracts, which exceed \$100,000 and that all such subrecipients shall certify and disclose accordingly.

Name of Consultant: \_\_\_\_\_

By: \_\_\_\_\_ Date: \_\_\_\_\_

Authorized Signature: \_\_\_\_\_

Title: \_\_\_\_\_



## DISCLOSURE OF LOBBYING ACTIVITIES

STATE OF FLORIDA DEPARTMENT OF TRANSPORTATION  
**DISCLOSURE OF LOBBYING ACTIVITIES**

375-030-34  
 PROCUREMENT  
 02/16

Is this form applicable to your firm?  
 YES  NO   
 If *no*, then please complete section 4  
 below for "Prime"

<b>1. Type of Federal Action:</b> a. contract b. grant c. cooperative agreement d. loan e. loan guarantee f. loan insurance	<b>2. Status of Federal Action:</b> a. bid/offer/application b. initial award c. post-award	<b>3. Report Type:</b> a. initial filing b. material change <b>For Material Change Only:</b> Year: _____ Quarter: _____ Date of last report: _____ (mm/dd/yyyy)
<b>4. Name and Address of Reporting Entity:</b> <input type="checkbox"/> Prime <input type="checkbox"/> Subawardee Tier _____, <i>if known</i> : _____ _____ _____ Congressional District, <i>if known</i> : 4c _____	<b>5. If Reporting Entity in No. 4 is a Subawardee, Enter Name and Address of Prime:</b> _____ _____ _____ Congressional District, <i>if known</i> : _____	
<b>6. Federal Department/Agency:</b> _____ _____	<b>7. Federal Program Name/Description:</b> _____ _____ CFDA Number, <i>if applicable</i> : _____	
<b>8. Federal Action Number, if known:</b> _____	<b>9. Award Amount, if known:</b> \$ _____	
<b>10. a. Name and Address of Lobbying Registrant</b> <i>(if individual, last name, first name, MI):</i> _____ _____ _____	<b>b. Individuals Performing Services</b> <i>(including address if different from No. 10a)</i> <i>(last name, first name, MI):</i> _____ _____ _____	
<b>11.</b> Information requested through this form is authorized by title 31 U.S.C. section 1352. This disclosure of lobbying activities is a material representation of fact upon which reliance was placed by the tier above when this transaction was made or entered into. This disclosure is required pursuant to 31 U.S.C. 1352. This information will be available for public inspection. Any person who fails to file the required disclosure shall be subject to a civil penalty of not less than \$10,000 and not more than \$100,000 for each such failure.	Signature: _____ Print Name: _____ Title: _____ Telephone No.: _____ Date (mm/dd/yyyy): _____	
<b>Federal Use Only:</b>		Authorized for Local Reproduction Standard Form LLL (Rev. 7-97)

## INSTRUCTIONS FOR COMPLETION OF SF-LLL, DISCLOSURE OF LOBBYING ACTIVITIES

This disclosure form shall be completed by the reporting entity, whether subawardee or prime Federal recipient, at the initiation or receipt of a covered Federal action, or a material change to a previous filing, pursuant to title 31 U.S.C. section 1352. The filing of a form is required for each payment or agreement to make payment to any lobbying entity for influencing or attempting to influence an officer or employee of any agency, a Member of Congress, an officer or employee of Congress, or an employee of a Member of Congress in connection with a covered Federal action. Complete all items that apply for both the initial filing and material change report. Refer to the implementing guidance published by the Office of Management and Budget for additional information.

1. Identify the type of covered Federal action for which lobbying activity is and/or has been secured to influence the outcome of a covered Federal action.
2. Identify the status of the covered Federal action.
3. Identify the appropriate classification of this report. If this is a followup report caused by a material change to the information previously reported, enter the year and quarter in which the change occurred. Enter the date of the last previously submitted report by this reporting entity for this covered Federal action.
4. Enter the fullname, address, city, State and zip code of the reporting entity. Include Congressional District, if known. Check the appropriate classification of the reporting entity that designates if it is, or expects to be, a prime or subaward recipient. Identify the tier of the subawardee, e.g., the first subawardee of the prime is the 1st tier. Subawards include but are not limited to subcontracts, subgrants and contract awards under grants.
5. If the organization filing the report in item 4 checks "Subawardee," then enter the full name, address, city, State and zip code of the prime Federal recipient. Include Congressional District, if known.
6. Enter the name of the Federal agency making the award or loan commitment. Include at least one organizational level below agency name, if known. For example, Department of Transportation, United States Coast Guard.
7. Enter the Federal program name or description for the covered Federal action (item 1). If known, enter the full Catalog of Federal Domestic Assistance (CFDA) number for grants, cooperative agreements, loans, and loan commitments.
8. Enter the most appropriate Federal identifying number available for the Federal action identified in item 1 (e.g., Request for Proposal (RFP) number; Invitation for Bid (IFB) number; grant announcement number; the contract, grant, or loan award number; the application/proposal control number assigned by the Federal agency). Include prefixes, e.g., "RFP-DE-90-001."
9. For a covered Federal action where there has been an award or loan commitment by the Federal agency, enter the Federal amount of the award/loan commitment for the prime entity identified in item 4 or 5.
10. (a) Enter the full name, address, city, State and zip code of the lobbying registrant under the Lobbying Disclosure Act of 1995 engaged by the reporting entity identified in item 4 to influence the covered Federal action.  
  
(b) Enter the full names of the individual(s) performing services, and include full address if different from 10 (a). Enter Last Name, First Name, and Middle Initial (MI).
11. The certifying official shall sign and date the form, print his/her name, title, and telephone number.

According to the Paperwork Reduction Act, as amended, no persons are required to respond to a collection of information unless it displays a valid OMB Control Number. The valid OMB control number for this information collection is OMB No. 0348-0046. Public reporting burden for this collection of information is estimated to average 10 minutes per response, including time for reviewing instructions, searching existing data sources, gathering and maintaining the data needed, and completing and reviewing the collection of information. Send comments regarding the burden estimate or any other aspect of this collection of information, including suggestions for reducing this burden, to the Office of Management and Budget, Paperwork Reduction Project (0348-0046), Washington, DC 20503.

# COLLUSION AFFIDAVIT

**COLLUSION AFFIDAVIT**

**(Code of Miami-Dade County Section 2-8.1.1 and 10-33.1) (Ordinance No. 08-113)**

BEFORE ME, A NOTARY PUBLIC, personally appeared \_\_\_\_\_ who being duly sworn states: (insert name of affiant)

I am over 18 years of age, have personal knowledge of the facts stated in this affidavit and I am an owner, officer, director, principal shareholder and/or I am otherwise authorized to bind the bidder of this contract.

I state that the bidder of this contract:

is not related to any of the other parties bidding in the competitive solicitation, and that the contractor's proposal is genuine and not sham or collusive or made in the interest or on behalf of any person not therein named, and that the contractor has not, directly or indirectly, induced or solicited any other proposer to put in a sham proposal, or any other person, firm, or corporation to refrain from proposing, and that the proposer has not in any manner sought by collusion to secure to the proposer an advantage over any other proposer.

**OR**

is related to the following parties who bid in the solicitation which are identified and listed below:

\_\_\_\_\_  
\_\_\_\_\_  
\_\_\_\_\_

Note: Any person or entity that fails to submit this executed affidavit shall be ineligible for contract award. In the event a recommended contractor identifies related parties in the competitive solicitation its bid shall be presumed to be collusive and the recommended contractor shall be ineligible for award unless that presumption is rebutted by presentation of evidence as to the extent of ownership, control and management of such related parties in the preparation and submittal of such bids or proposals. Related parties shall mean bidders or proposers or the principals, corporate officers, and managers thereof which have a direct or indirect ownership interest in another bidder or proposer for the same agreement or in which a parent company or the principals thereof of one (1) bidder or proposer have a direct or indirect ownership interest in another bidder or proposer for the same agreement. Bids or proposals found to be collusive shall be rejected.

By: \_\_\_\_\_  
Signature of Affiant

\_\_\_\_\_ 20 \_\_\_\_  
Date

\_\_\_\_\_  
Printed Name of Affiant and Title

\_\_\_\_/\_\_\_\_/\_\_\_\_-\_\_\_\_/\_\_\_\_/\_\_\_\_/\_\_\_\_/\_\_\_\_/\_\_\_\_/\_\_\_\_  
Federal Employer Identification Number

\_\_\_\_\_  
Printed Name of Firm

\_\_\_\_\_  
Address of Firm

**SUBSCRIBED AND SWORN TO** (or affirmed) before me this \_\_\_\_\_ day of \_\_\_\_\_, 20\_\_\_\_

He/She is personally known to me or has presented \_\_\_\_\_ as identification. Type of identification

\_\_\_\_\_  
Signature of Notary

\_\_\_\_\_  
Serial Number

\_\_\_\_\_  
Print or Stamp Name of Notary

\_\_\_\_\_  
Expiration Date

Notary Public – State of \_\_\_\_\_

**Notary Seal**

Revised 4/12/99

## AFFIRMATION OF VENDOR AFFIDAVITS



# New Vendor Registration and Bid/Proposal Contract Language

## 1.1. DEFINITIONS FOR VENDOR REGISTRATION

**Bid** – shall refer to any offer(s) submitted in response to this solicitation.

**Bidder** – shall refer to anyone submitting a Bid in response to this solicitation.

**Bid Solicitation** – shall mean this solicitation documentation, including any and all addenda.

**Bid Submittal Form** – defines the requirement of items to be purchased, and must be completed and submitted with Bid. The Bidder should indicate its name in the appropriate space on each page.

**County** – shall refer to Miami-Dade County, Florida

**DPM** – shall refer to Miami-Dade County's Department of Procurement Management.

**Enrolled Vendor** – shall refer to a firm that has completed the necessary documentation in order to receive Bid notifications from the County.

**Registered Vendor** – shall refer to a firm that has completed the Miami-Dade County Business Entity Registration Application and has satisfied all requirements to enter into business agreements with the County.

**The Vendor Registration Package** – shall refer to the Business Entity Registration Application.

For additional information about on-line vendor enrollment or vendor registration contact the Vendor Assistance Unit at 111 N.W. 1<sup>st</sup> Street, 13<sup>th</sup> Floor, Miami, FL 33128, Phone 305-375-5773. Vendors can enroll online and obtain forms to register by visiting our web site at [www.miamidade.gov/dpm](http://www.miamidade.gov/dpm)

## 1.2. INSTRUCTIONS TO BIDDERS

### A. Bidder Qualification

It is the policy of the County to encourage full and open competition among all available qualified vendors. All vendors regularly engaged in the type of work specified in the Bid Solicitation are encouraged to submit Bids. Vendors may enroll with the County to be included on a notification list for selected categories of goods and services. To be eligible for award of a contract (including small purchase orders), Bidders must become a Registered Vendor. Only Registered Vendors can be awarded County contracts. Vendors are required to register with the County by contacting the Vendor Assistance Unit. The County endeavors to obtain the participation of all qualified small business enterprises. For information and to apply for certification, contact the Department of Small Business Development at 111 N.W. 1<sup>st</sup> Street, 19<sup>th</sup> Floor, Miami, FL 33128-1900, or telephone at 305-375-3111. County employees and board members wishing to do business with the County are referred to Section 2-11.1 of the Miami-Dade County Code relating to Conflict of Interest and Code of Ethics.

### B. Vendor Registration

To be recommended for award the County requires that vendors complete a Miami-Dade County Vendor Registration Package. Effective June 1, 2008, a new Vendor Registration Package, including a Uniform Affidavit Packet (Affidavit form), must be completed by vendors and returned to the Department of Procurement Management (DPM), Vendor Assistance Unit, within fourteen (14) days of notification of the intent to recommend for award. In the event the Vendor Registration Package is not properly completed and returned within the specified time, the County may in its sole discretion, award to the next lowest responsive, responsible Bidder. The Bidder is responsible for obtaining the Vendor Registration Package, including all affidavits by downloading from the DPM website at [www.miamidade.gov](http://www.miamidade.gov) or from the Vendor Assistance Unit at 111 N.W. 1<sup>st</sup> Street, 13<sup>th</sup> Floor, Miami, FL 33128.

Bidders are required to affirm that all information submitted with the Vendor Registration Package is current, complete and accurate, at the time they submit a response to a Bid Solicitation, by completing the provided Affirmation of Vendor Affidavit form.

In becoming a Registered Vendor with Miami-Dade County, the vendor confirms its knowledge of and commitment to comply with the following:

1. **Miami-Dade County Ownership Disclosure Affidavit**  
(Sec. 2-8.1 of the County Code)
2. **Miami-Dade County Employment Disclosure Affidavit**  
(County Ordinance No. 90-133, amending Section 2-8.1(d)(2) of the County Code)
3. **Miami-Dade County Employment Drug-free Workplace Certification**  
(Section 2-8.1.2(b) of the County Code)
4. **Miami-Dade Disability and Nondiscrimination Affidavit**  
(Article 1, Section 2-8.1.5 Resolution R182-00 Amending R-385-95)
5. **Miami-Dade County Debarment Disclosure Affidavit**  
(Section 10.38 of the County Code)
6. **Miami-Dade County Vendor Obligation to County Affidavit**  
(Section 2-8.1 of the County Code)
7. **Miami-Dade County Code of Business Ethics Affidavit**  
(Article 1, Section 2-8.1(j) and 2-11(b)(1) of the County Code through (6) and (9) of the County Code and County Ordinance No 00-1 amending Section 2-11.1(c) of the County Code)
8. **Miami-Dade County Family Leave Affidavit**  
(Article V of Chapter 11 of the County Code)

### 9. Miami-Dade County Living Wage Affidavit

(Section 2-8.9 of the County Code) (Does not apply to this contract)

### 10. Miami-Dade County Domestic Leave and Reporting Affidavit

(Article 8, Section 11A-60 11A-67 of the County Code)

### 11. Subcontracting Practices

(Ordinance 97-35)

### 12. Subcontractor /Supplier Listing

(Ordinance 97-104)

### 13. Environmentally Acceptable Packaging

Resolution (R-738-92)

### 14. W-9 and 8109 Forms

The vendor must furnish these forms as required by the Internal Revenue Service.

### 15. Social Security Number

In order to establish a file for your firm, you must provide your firm's Federal Employer Identification Number (FEIN). If no FEIN exists, the Social Security Number of the owner or individual must be provided. This number becomes your "County Vendor Number". To comply with Section 119.071(5) of the Florida Statutes relating to the collection of an individual's Social Security Number, be aware that DPM requests the Social Security Number for the following purposes:

- Identification of individual account records
- To make payments to individual/vendor for goods and services provided to Miami-Dade County
- Tax reporting purposes
- To provide a unique identifier in the vendor database that may be used for searching and sorting departmental records

### 16. Office of the Inspector General

Pursuant to Section 2-1076 of the County Code.

### 17. Small Business Enterprises (Does not apply to this contract)

The County endeavors to obtain the participation of all small business enterprises pursuant to Sections 2-8.2, 2-8.2.3 and 2-8.2.4 of the County Code and Title 49 of the Code of Federal Regulations.

### 18. Antitrust Laws

By acceptance of any contract, the vendor agrees to comply with all antitrust laws of the United States and the State of Florida.

### C. PUBLIC ENTITY CRIMES

To be eligible for award of a contract, firms wishing to do business with the County must comply with the following:

Pursuant to Section 287.133(2)(a) of the Florida Statutes, a person or affiliate who has been placed on the convicted vendor list following a conviction for a public entity crime may not submit a Bid on a contract to provide any goods or services to a public entity, may not submit a Bid on a contract with a public entity for the construction or repair of a public building or public work, may not submit Bids on leases of real property to a public entity, may not be awarded or perform work as a contractor, supplier, subcontractor, or consultant under a contract with any public entity, and may not transact business with any public entity in excess of the threshold amount provided in Section 287.017 of the Florida Statutes, for CATEGORY TWO for a period of 36 months from the date of being placed on the convicted vendor list.





## **SECTION 3: INSTRUCTIONS TO BIDDERS**

## SUPPLEMENTARY INSTRUCTIONS TO BIDDERS

**SUPPLEMENTARY INSTRUCTIONS TO BIDDERS**

**TABLE OF CONTENTS**

**1. SUPPLEMENTAL BIDDING REQUIREMENTS**

---

1.01 BID FORMS.....2

1.02 BID SECURITY .....3

1.03 CERTIFICATION PURSUANT TO ACT RELATING TO SCRUTINIZED COMPANIES .....3

1.04 DISADVANTAGED BUSINESS ENTERPRISE (DBE) PROGRAM.....3

1.05 SITE INVESTIGATION.....4

1.06 CONTRACTOR QUALIFICATION REQUIREMENTS .....4

1.07 AWARD OF CONTRACT .....5

1.08 PAYMENT AND PERFORMANCE BONDS .....6

1.09 ADDITIONAL INSURANCE TO BE CARRIED BY CONTRACTOR .....7

## 1. SUPPLEMENTAL BIDDING REQUIREMENTS

---

### 1.01 BID FORMS

#### A. Estimated Quantities.

1. The Bid Form contains estimated quantities that are provided for bidding purposes only. The actual quantities required to construct the Work may vary from those shown. The County reserves the right to increase, or decrease the quantities, or to delete any of the items for which there is no need throughout the length of the Contract.
2. Bid Items which are estimated with a unit quantity of one are anticipated to be use in minimal quantities, if any, as approved by the Engineer. Any Contract provisions pertaining to adjustments in item prices shall not apply. Therefore, no adjustment shall be made to the unit prices awarded as a result of changes to the estimated quantities provided in the Bid Form. Final quantities shall be as approved by the Engineer.

#### B. Preparation of Proposal.

1. All blank spaces on the Bid Form for bid prices must be filled in ink, in both words and figures. In the event of any discrepancy in the entries for the price of any item, the unit price as shown in words shall govern unless both the extension and the unit prices shown in figures are in agreement with each other, in which case they shall govern over the unit price shown in words.
2. If the Bid is made by an individual, a sole proprietorship or an individual operating under a trade name, the name and post office address of the individual or owner must be shown in each instance. If made by a partnership, the Bid must be signed by one of the partners, and the names and addresses of the partners must be listed. If made by a corporation, the Bid must be signed by an authorized officer or agent of the corporation, the corporation must be clearly identified and the corporate seal must be affixed. In addition, a Bid made by a corporation must also list the name of the state wherein the corporation was chartered and the business address of the corporation.
3. Bids must be submitted only on the hardcopy Bid form provided with these Contract Documents unless a revised Bid Form is provided by the County via Addendum, in which case the latest Bid Form provided by Addendum shall be used.
4. All required forms must be completed and submitted and, all blanks must be filled in.

#### C. Rejection of Irregular Proposals.

1. Bids will be considered irregular, and may be rejected, if they show omissions, alterations of form, additions not called for, conditions or unauthorized alternate bids, or irregularities of any kind; or if the unit prices are obviously unbalanced either in excess of or below a reasonable cost analysis value.

#### D. Pay Items.

1. Any work not specifically mentioned in the pay items listed in the Proposal, but indicated on the plans and/or specifications, shall be considered as incidental to one or more of the pay items, and no claim for additional compensation will be allowed, and it shall be assumed that the cost therefore is included in the prices for the various items in the Contract.

## 1.02 BID SECURITY

- A. Simultaneously with the delivery of the Bid to the County, on or before the bid due date, the Bidder must deliver to the County a bid security in the form of a Bid Bond on the form provided in the Bidding Documents or in Cash, in the form of a Certified Check, Cashier's Check or Irrevocable Letter of Credit made payable to the Department, for an amount equal to no less than five percent of the Total amount Bid. Failure to furnish a bid security in the proper form and amount, with the delivery of the Bid to the County, shall result in the Bid being declared "non-responsive."
- B. A Bid Bond shall have as the surety thereon only such surety company or companies that are acceptable to the County and are authorized to write bonds of such character and amount in accordance with the qualifications established for Payment and Performance Bonds.
- C. The bid security submitted with the Bid becomes payable to the County upon default of the Bidder. Default of Bidder shall occur in the event that the Bidder withdraws Bid within 180 days after bid opening (or any extension thereof agreed to in writing by the Bidder and County); or, after proper notification of intent to Contract from the County, fails to comply with all pre-award requirements including, but not limited to providing Payment and Performance Bonds with good and sufficient surety and the necessary Insurance Certificates pursuant to the Contract Documents, and enter into a written Contract with the County, as may be required; all within 10 days after the prescribed forms are presented to Principal for signature or as otherwise required by these Bidding Documents.

## 1.03 CERTIFICATION PURSUANT TO ACT RELATING TO SCRUTINIZED COMPANIES

- A. This section shall apply only to the extent permitted under applicable regulations of the United States Department of State and the United States Department of Treasury.
- B. By submitting a bid executed through a duly authorized representative, the bidder certifies that the bidder is not on the Scrutinized Companies with Activities in Sudan List, Scrutinized Companies with Activities in the Iran Petroleum Energy Sector List, Scrutinized Companies that boycott Israel List or engaged in a boycott of Israel as those terms are used and defined in sections 287.135 and 215.473 of the Florida Statutes. In the event that the bidder is unable to provide such certification but still seeks to be considered for award of this solicitation, the bidder shall, on a separate piece of paper, clearly state that it is on one or both of the Scrutinized Companies lists and shall furnish together with its bid a duly executed written explanation of the facts supporting any exception to the requirement for certification that it claims under Section 287.135 of the Florida Statutes. The bidder agrees to cooperate fully with the County in any investigation undertaken by the County to determine whether the claimed exception would be applicable. The County shall have the right to terminate any contract resulting from this solicitation for default if the bidder is found to have submitted a false certification or to have been placed on the Scrutinized Companies for Activities in Sudan List, the Scrutinized Companies with Activities in the Iran Petroleum Energy Sector List, Scrutinized Companies that boycott Israel List or engaged in a boycott of Israel.

## 1.04 DISADVANTAGED BUSINESS ENTERPRISE (DBE) PROGRAM

- A. The Contractor shall comply with the requirements pursuant to 49 Code of Federal Regulations (CFR) Part 26 as implemented by the approved FDOT DBE Program.
- B. For more information on the DBE Program refer to Article 1.10 of the Supplementary Conditions of these Solicitation Documents.

## 1.05 SITE INVESTIGATION

- A. Examine the Contract Documents and the site of the proposed work, when applicable, carefully before submitting a proposal for the work contemplated. Investigate the conditions to be encountered, as to the character, quality, and quantities of work to be performed and materials to be furnished and as to the requirements of all Contract Documents.
- B. The Department does not guarantee the details pertaining to borings, as shown on the plans, to be more than a general indication of the materials likely to be found adjacent to holes bored at the site of the work, approximately at the locations indicated. The Contractor shall examine boring data, where available, and make his own interpretation of the subsoil investigations and other preliminary data, and shall base his bid on his own opinion of the conditions likely to be encountered.
- C. The bidder's submission of a proposal is sufficient evidence that the bidder has made an examination as described in this Article. Therefore:
  1. The bidder, by virtue of submitting their bid, acknowledges that they and all their subcontractors have satisfied themselves as to the nature and location of the Work or requirements of similar Work to be performed within Miami-Dade County Public Right-of-Ways. The general and local conditions include, but are not restricted to those bearing upon transportation and traffic maintenance; the disposal, handling and storage of materials; access roads to the site; site constraints, restrictions and limitations; the conformation and conditions of the work area; and the character of equipment and facilities needed prior to and during the performance of the Work.
  2. Failure on the part of the bidder to completely or properly evaluate any factors of costs prior to bidding shall not form a basis for additional compensation if awarded the Contract.

## 1.06 CONTRACTOR QUALIFICATION REQUIREMENTS

- A. Certificate of Competency Requirement:
  1. Pursuant to the requirements of Section 10-3 of the Code of Miami-Dade County, Florida and these Solicitation and Contract Documents, the Bidder must hold a valid, current, and active:
    - a. Certificate of Competency from the County's Construction Trades Qualifying Board as an Electrical Contractor or a General Engineering Contractor or as a Specialty Engineering Contractor, commensurate to the requirements of the Scope of Work, in one or more engineering crafts to include, paving engineering or concrete-work engineering contractor. The specialty contractor shall subcontract with a qualified contractor any work which is incidental to the specialty but is specified in the aforementioned Code as being the work of other than that of the Engineering Specialty for which certified; or
    - b. Certification, as an electrical contractor, provided by the State of Florida Electrical Contractors Licensing Board, pursuant to the provisions of Section 489.511 of the Florida Statutes (F.S.); or;
  2. Pursuant to Section 255.20, F.S. and in lieu of the above, the County may consider a bid from a Bidder that is a duly licensed Contractor in good standing that has been prequalified and considered eligible by the Florida Department of Transportation (FDOT) under Section 337.14, F.S. and Chapter 14-2, Florida Administrative Code, to perform the work described in the Contract Documents. Contractors seeking consideration under this Paragraph shall submit

along with the Bid Documents for review and consideration, current copy(ies) of their FDOT Certificate(s) of Qualification, Certification of Work Underway, and Status of Contract(s) On Hand. Acceptable FDOT prequalification(s) necessary to perform the Work specified in the Contract Documents include the Traffic Signal Work Class.

B. Experience Requirement:

1. The Bidder must demonstrate that it has full-time personnel with the necessary experience to perform the Project's Scope of Work. This experience shall include work in successfully completed projects performed by the identified personnel whose bulk of work performed in the Public Right-of-Way is similar in detail to the Project's Scope of Work described in these Solicitation Documents. Demonstrate the experience requirement by:
  - a. Providing a detailed description of at least three (3) projects similar in detail to the Project's Scope of Work described in these Solicitation Documents and in which the Bidder's identified personnel is currently engaged or has completed within the past five years. List and describe the aforementioned projects and state whether the work was performed for the County, other government clients, or private entities. The description must identify for each project:
    - 1) The identified personnel and their assigned role and responsibilities for the listed project
    - 2) The client name and address including a contact person and phone number for reference
    - 3) Description of work
    - 4) Total dollar value of the contract
    - 5) Contract duration
    - 6) Statement or notation of whether Bidder's referenced personnel is/was employed by the prime contractor or subcontractor, and
    - 7) For completed projects, provide letters of certification of final acceptance or similar project closure documentation issued by the client and available Contractor's performance evaluations; or
  - b. Pursuant to Section 255.20, F.S. and in lieu of the above, the County may consider a bid from a Bidder that is a duly licensed Contractor in good standing that has been prequalified and considered eligible by the Florida Department of Transportation (FDOT) under Section 337.14, F.S. and Chapter 14-2, Florida Administrative Code, to perform the work described in the Contract Documents. Contractors seeking consideration under this Paragraph shall submit along with the Bid Documents for review and consideration, current copy(ies) of their FDOT Certificate(s) of Qualification, Certification of Work Underway, and Status of Contract(s) On Hand. Acceptable FDOT prequalification(s) necessary to perform the Work specified in the Contract Documents include the Pavement Marking Work Class.
2. The County reserves the right to request additional information and/or contact listed persons pertaining to bidder's experience.

1.07 AWARD OF CONTRACT

- A. The award of the Contract, if it be made in the County's sole discretion, shall be to the lowest responsive and responsible bidder whose bid complies with all of the material terms of this solicitation and is determined to be in the best interest of the County.
- B. A fully executed Notice to Proceed (NTP) Letter constitutes a contract with Miami-Dade County. The County may issue to the Contractor a NTP Letter only when, in the discretion of Miami-Dade County, all conditions for award have been satisfied including, but not limited to, compliance with all of the requirements set forth in the Recommendation for Award letter and the expiration of any applicable protest period. The Contractor must provide the County with the completed and fully executed NTP Letter prior to the date stated in the letter for commencement of the Work. The award is final only upon the County's receipt of a fully executed NTP Letter from the Contractor.
- C. By submitting a bid, the bidder acknowledges that the County shall have the right to investigate the existence of these factors in determining whether to award the bid, and to evaluate, without limitation, the bidder's outstanding commitments on other awarded contracts, its resources to perform the Work under the Contract, and its past performance.
- D. The County reserves the right to waive any informality in, or to reject any or all bids. Bids from any person, firm or corporation in default upon any agreement with the County will be rejected.
- E. The Bidders should be qualified by experience, financing, and equipment to do the work described in the Contract Documents. The County may require from the apparent lowest responsive and responsible Bidder, as a condition for Award, a list of the major construction equipment that is available to perform all the work required by the Contract. The list shall include all equipment required and available including: quantity; condition; make and model; whether owned or leased; and their present location. Actual proof of ownership (bills of sale or certified proof of a valid lease in the name of the firm submitting the Bid) of the equipment or the ability to secure the equipment prior to Contract Award is required. A visual inspection by the County of the equipment listed shall be facilitated within 10 days of submittal of the aforementioned list. Failure to meet the timeframes and conditions stipulated herein or in the Recommendation for Award may result in the disqualification of the Bidder.

1.08 PAYMENT AND PERFORMANCE BONDS

- A. The successful bidder shall submit, within the timeframe stipulated in the Recommendation for Award, duly executed Payment and Performance Bonds, meeting the requirements of Section 255.05, F.S., on the forms prescribed by the Department or in Cash, each in the amount of the total contract price (i.e. the accepted total amount bid plus any contingency and dedicated allowances attributable to the Contract), as security for the faithful performance of this Contract and for the payment of all persons performing labor or furnishing materials in connection therewith. If Cash is used in lieu of the bonds, all terms and conditions stipulated in the bonds shall be just as applicable.
- B. The Performance and Payment Bonds shall have as the surety thereon only such surety company or companies as are acceptable to the County and are authorized to write bonds of such character and amount in accordance with the following qualifications:
  - 1. All bonds shall be written through surety insurers authorized to do business in the State of Florida as surety, with the following qualifications as to management and financial strength according to the latest edition of Best's Insurance Guide, published by A.M. Best Company, Oldwick, New Jersey:

<u>Bond Amount (\$)</u>	<u>Best Rating</u>
500,001 to 1,500,000	B V



1,500,001 to 2,500,000	A VI
2,500,001 to 5,000,000	A VII
5,000,000 to 10,000,000	A VIII
Over 10,000,000	A IX

2. On contract amounts of \$500,000 or less, the bond provisions of Section 287.0935, F.S. shall be in effect and surety companies not otherwise qualifying with this paragraph may optionally qualify by:
    - a. Providing evidence that the Surety has twice the minimum surplus and capital required by the Florida Insurance Code at the time the invitation to bid is issued.
    - b. Certifying that the Surety is otherwise in compliance with the Florida Insurance Code, and;
    - c. Providing a copy of the currently valid Certificate of Authority issued by the United States Department of the Treasury under ss. 31 U.S.C. 9304-9308.
  3. Surety insurers shall be listed in the latest Circular 570 of the U.S. Department of the Treasury entitled "Surety Companies Acceptable on Federal Bonds", published annually. The bond amount shall not exceed the underwriting limitations as shown in this circular.
  4. For contracts in excess of \$500,000 the provision of Subarticle 2 above will be adhered to plus the company must have been listed for at least three consecutive years, or holding a valid Certificate of Authority of at least 1.5 million dollars and on the Treasury List.
  5. Surety Bonds guaranteed through U.S. Government Small Business Administration or Contractors Training and Development Inc. will also be acceptable.
  6. The attorney-in-fact or other officer who signs performance and payment bonds for a surety company must file with such bond a certified copy of his power of attorney authorizing him to do so. The performance and payment bonds must be counter signed by the surety's resident Florida agent.
- C. The Payment and Performance Bonds must be executed on the forms provided by the Department after the recommendation of award has been made. Failure to do so shall result in the rescission of the contract award recommendation.
  - D. Provide the County with three executed originals of the Payment and Performance Bonds and a letter from the bonding agent granting Miami-Dade County authorization to date the Bonds.
  - E. The required bond(s) shall be written by or through and countersigned by a licensed Florida agent of the surety insurer pursuant to Section 624.425, F.S.
  - F. In the event the Surety on the bond(s) given by the Contractor becomes insolvent, or is placed in the hands of a receiver, or has its right to do business in its State of domicile or the State of Florida suspended or revoked as provided by law, or in the event of cancellation of the required hands by the Surety, the County shall withhold all payments until the Contractor shall give good and sufficient bond(s) in lieu of the bond(s) executed by such Surety.

1.09 ADDITIONAL INSURANCE TO BE CARRIED BY CONTRACTOR

Subparagraphs 2.9A through 2.9G of the Special Conditions to the CICC 7360-0/08 are deleted and replace with the following:

- A. To the extent provided by law, Contractor shall indemnify, defend, and hold harmless the County and the State of Florida, Department of Transportation, including FDOT's officers, agents, and employees, against any actions, claims, or damages arising out of, relating to, or resulting from negligent or wrongful act(s) of the Contractor, or any of its officers, agents, or employees, acting within the scope of their office or employment, in connection with the rights granted to or exercised by the Contractor, hereunder, to the extent and within the limitations of Section 768.28, Florida Statutes.
- B. The foregoing indemnification shall not constitute a waiver of sovereign immunity beyond the limits set forth in Florida Statutes, Section 768.28. Nor shall the same be construed to constitute agreement by the Contractor to indemnify the County for the negligent acts or omissions of the County, its officers, agents, or employees, or third parties. Nor shall the same be construed to constitute agreement by the Contractor to indemnify FDOT's for the negligent acts or omissions of FDOT's officers, agents, or employees, or third parties. This indemnification shall survive the termination of this Agreement.
- C. This indemnification shall survive the termination of this Agreement. Nothing contained in this paragraph is intended to nor shall it constitute a waiver of the State of Florida and the County's sovereign immunity.
- D. The Contractor shall furnish the Department of Transportation and Public Works, 111 NW 1<sup>st</sup> Street, Miami Florida 33128, Certificate(s) of Insurance which indicate that insurance coverage has been obtained which meets the requirements as outlined below:
  1. Worker's compensation insurance for all employees as required by Florida Statute 440.
  2. Commercial General Liability in an amount not less than \$1,000,000 per occurrence \$2,000,000 aggregate. Coverage to include products/completed operations and XCU. Miami-Dade County shall be included as additional insured.
  3. Automobile Liability covering all owned, non-owned and hired vehicles in an amount not less than \$1,000,000 combined single limit.

All insurance policies required above shall be issued by companies authorized to do business under the laws of the State of Florida, with the following qualifications:

1. The company must be rated no less than "A-" as to management, and no less than "Class VII" as to financial strength, by Best's Insurance Guide, published by A.M. Best Company, Oldwick, New Jersey, or its equivalent, subject to the approval of the County Risk Management Division.  
Or;
2. The company must hold a valid Florida Certificate of Authority as shown in the latest "List of All Insurance Companies Authorized or Approved to Do Business in Florida" issued by the State of Florida Department of Financial Services.  
Certificate holder must read: MIAMI-DADE COUNTY, 111 NW 1<sup>st</sup> STREET, SUITE 2340, MIAMI, FL. 33128 and FLORIDA DEPARTMENT OF TRANSPORTATION 1000 NW 111TH AVE, MIAMI, FL 33172.

## **SECTION 4: SUPPLEMENTAL INFORMATION**

# SAMPLE SURETY PERFORMANCE AND PAYMENT BOND

### SURETY PERFORMANCE AND PAYMENT BOND

By this Bond, We \_\_\_\_\_, as Principal, whose principal business address is \_\_\_\_\_, as Contractor under the contract dated \_\_\_\_\_, 20 \_\_\_\_, between Principal and Miami-Dade County for the construction of \_\_\_\_\_ Project No. \_\_\_\_\_ (herein after referred to as "Contract") the terms of which Contract are incorporated by reference in its entirety into this Bond and

\_\_\_\_\_, a corporation, whose principal business address is \_\_\_\_\_ as Surety, are bound to Miami-Dade County (hereinafter referred to as "County") in the sum of \_\_\_\_\_ (U.S. dollars) \$ \_\_\_\_\_, for payment of which we bind ourselves, our heirs, personal representatives, successors, and assigns, jointly and severally.

THE CONDITION OF THIS BOND is that if Principal:

1. Performs all the work under the Contract, including but not limited to guarantees, warranties and the curing of latent defects, said Contract being made a part of this bond by reference, and in the times and in the manner prescribed in the Contract, including any and all damages for delay; and
2. Promptly makes payments to all claimants, as defined in Section 255.05(1), Florida Statutes, supplying Principal with labor, materials, or supplies, used directly or indirectly by Principal in the prosecution of the work provided for in the contract; and
3. Pays County all losses, damages, including damages for delay, expenses, costs and attorney's fees, including appellate proceedings, that County sustains because of a default by Principal under the Contract, including but not limited to a failure to honor all guarantees and warranties.
4. Performs the guarantee of all work and materials furnished under the contract for the time specified in the Contract, including all warranties.

If no specific periods of warranty are stated in the Contract for any particular item or work, material or equipment, the warranty shall be deemed to be a period of one (1) year from the date of final acceptance by the County. This Bond does not limit the County's ability to pursue suits directly with the Principal seeking damages for latent defects in materials or workmanship, such actions being subject to the limitations found in Section 95.11(3) (c), Florida Statutes.

Any changes in or under the Contract Documents and compliance or noncompliance with any formalities connected with the Contract or the changes does not affect Surety's obligation under this Bond.

**SURETY PERFORMANCE BOND (Cont'd)**

IN WITNESS WHEREOF, the above bounden parties have caused this Bond to be executed by their appropriate officials as of the \_\_\_\_\_ day of \_\_\_\_\_, 20\_\_.

**SAMPLE ONLY**

CONTRACTOR

\_\_\_\_\_  
(Contractor Name)

BY:

\_\_\_\_\_  
(President) (Managing Partner or Joint Venture)

(SEAL)

COUNTERSIGNED BY RESIDENT  
FLORIDA AGENT OF SURETY:

\_\_\_\_\_

(Copy of Agent's current  
Identification Card as issued by  
State of Florida Insurance Commissioner must be attached) By: \_\_\_\_\_

SURETY:

\_\_\_\_\_

Attorney-in-Fact

(CORPORATE SEAL)

(Power of Attorney must be attached)

## **SECTION 5: SUPPLEMENTARY CONDITIONS**

## SUPPLEMENTARY CONDITIONS



**SUPPLEMENTARY CONDITIONS**  
**TABLE OF CONTENTS**

**1. SUPPLEMENTARY CONDITIONS**

---

1.01	MISCELLANEOUS CONSTRUCTION CONTRACT (7360 PLAN).....	1
1.02	APPLICABLE WAGE RATES.....	1
1.03	CONTINGENCY ALLOWANCE FOR TIME.....	1
1.04	WEATHER DELAYS .....	2
1.05	ADDITIONAL REQUIREMENTS FOR FEDERALLY FUNDED CONTRACTS.....	3
1.06	LAWS & REGULATIONS .....	3
1.07	CONTRACTOR RESPONSIBILITIES .....	5
1.08	TITLE VI ASSURANCE – DOT 1050.2A, APPENDIX A AND APPENDIX E.....	8
1.09	ADDITIONAL SBE-CONST CONTRACT MEASURE REQUIREMENTS.....	10
1.10	DISADVANTAGED BUSSINESS ENTERPRISE PROGRAM .....	10
1.11	MATERIALS ACCEPTANCE AND CERTIFICATION SYSTEM (MAC).....	13
1.12	ON-THE-JOB TRAINING REQUIREMENTS.....	14
1.13	COMMUNITY WORKFORCE PROGRAM .....	19
1.14	CLEARINGHOUSE FOR POSTING NOTICE OF JOB OPPORTUNITIES .....	19
1.15	RESIDENTS FIRST TRAINING AND EMPLOYMENT PROGRAM COMPLIANCE .....	19
1.16	EMPLOY MIAMI-DADE PROGRAM.....	19
1.17	ACCEPTANCE TESTS .....	19
1.18	CHANGE ORDER PROCEDURES AND BASIS FOR PAYMENT .....	19
1.19	MIAMI-DADE COUNTY’S USER ACCESS PROGRAM (UAP).....	20
1.20	PUBLIC RECORDS AND CONTRACTS FOR SERVICES PERFORMED ON BEHALF OF MIAMI-DADE COUNTY.....	20
1.21	NONDISCRIMINATION.....	21
1.22	CONTRACTOR DUE DILIGENCE AFFIDAVIT .....	21
1.23	CLAIMS .....	22
1.24	DISPUTES.....	25
1.25	EXTRA WORK .....	27
1.26	WARRANTY OF CONSTRUCTION .....	31
1.27	CONFLICT OF INTEREST .....	31

APPENDIX TO THE SUPPLEMENTARY CONDITIONS

Appendix A: Davis Bacon Wages

Appendix B: FHWA-1273 Required Contract Provisions for Federal Aid Construction Contracts

Appendix C Executive Order 11246 Equal Employment Opportunity

Appendix D Small Business Division, Project Worksheet

Appendix E (OSHA) Form 300, 300A and 301

## 1. SUPPLEMENTARY CONDITIONS

---

### 1.01 MISCELLANEOUS CONSTRUCTION CONTRACT (7360 PLAN)

- A. These Supplementary Conditions amend or supplement the Miscellaneous Construction Contract (MCC) CICC 7360-0/08, the MCC 7360 Plan, and other provisions of the Contract Documents as indicated below. All provisions that are not so amended or supplemented remain in full force and effect. All requirements of the Contract Documents, or portions thereof, which are not specifically modified, deleted, or superseded hereby, remain in full effect. The MCC Contract and Plan may also be supplemented elsewhere in the Contract Documents by provisions located in, but not necessarily limited to, Division 1 (General Requirements) of the Contract Specifications.

### 1.02 APPLICABLE WAGE RATES

- A. Amend Paragraph 2.18 of the CICC 7360-0/08 Miscellaneous Construction Contract with the following:
1. The overall per hour rate shall be the rate of wages (including fringes) to be paid under the requirements of the Davis-Bacon Act as determined by the U.S. Department of Labor under the Davis-Bacon Act on project contracts. The listed Davis Bacon Wage Rate listed below is applicable to this contract, and/or any modification up to ten (10) days prior to the opening of the bids.
  2. The applicable U.S. Department of Labor (DOL) Davis Bacon Wage Determination, Construction Type: Highway, is **FL20220178 Modification Number 1**, and is provided as Appendix A to these Supplementary Conditions, subject to modification pursuant to 29 CFR 1.6. A copy of the Davis-Bacon Wage Determination for the work can also be obtained from the DOL website at <http://www.wdol.gov/dba.aspx>. Contractor must comply with the minimum rates for wages for laborers and mechanics as determined by the Secretary of Labor in accordance with the provisions of the Davis-Bacon and Related Acts. For the submittal of additional Davis Bacon wage classification requests please refer to the Florida Department of Transportation "Classification Request Manager" at the following link: <http://www.dot.state.fl.us/construction/Wage.shtm>.
  3. Certified payrolls submitted must contain all of the information required to be maintained under 29 CFR 5.5 (a) (3) (i) except that full social security numbers and home addresses must not be included. An individual identifying number for each employee (e.g. last four digits of social security number) may be used. Unless a specific form is required by the Contract Documents pursuant to funding source requirements, a general form to submit certified weekly payrolls for contracts subject to the Davis-Bacon and related Acts may be obtained at the DOL website at <http://www.dol.gov/whd/forms/wh347.pdf>. Instructions for completing the payroll form are available at <http://www.dol.gov/whd/forms/wh347instr.htm>.

### 1.03 CONTINGENCY ALLOWANCE FOR TIME

- A. The subject contract is federally funded, therefore there is not contingency allowance for time under this project. Any additional time requires justification as required by 23 CFR635 and must be approved by FDOT.

1.04 WEATHER DELAYS

A. Schedule of Anticipated Weather Delay Days

1. The following schedule of average climatic range, based on National Oceanic and Atmospheric Administration (NOAA) normal data (1981-2010 Monthly Normals; GHCN Daily ID: USW00012839; MIAMI INTL AP, FL), will be used as the standard baseline for monthly evaluations of weather delays for this Contract.

Schedule of Anticipated Weather Delay Days												
Month	JAN	FEB	MAR	APR	MAY	JUN	JUL	AUG	SEP	OCT	NOV	DEC
Days	3	4	4	4	7	12	11	13	13	8	4	4

2. The above schedule provides the anticipated number of days each month during which construction activity exposed to weather conditions is expected to be prevented and suspended by cause of adverse weather. Suspension of construction activity for the number of days listed in the schedule, for each month, is included in the Work and is not eligible for extension of Contract Time. The Work Progress Schedule submitted by Contractor must reflect these anticipated adverse weather delays in all weather dependent activities.

B. Extension of Contract Time for Adverse Weather Days In Excess of the Standard Baseline

1. If the basis exists, in accordance with the Conditions of the Contract, for a claim for extension of time, an extension of time on the basis of weather may be granted only for the number of Weather Delay Days in a month that are in excess of the number of days listed above for that month in the Schedule of Anticipated Adverse Weather Delay Days.
2. Adverse Weather Day is defined, for the purpose of this Article, as the occurrence of one or more of the following weather conditions within a twenty-four (24) hour day that prevents scheduled critical path construction activity exposed to weather conditions:
  - a. Precipitation in excess of one-tenth inch (0.10").
  - b. Temperatures that do not rise above that required for the day's construction activity, if such temperature requirement is specified or accepted as standard industry practice.
  - c. Sustained wind in excess of twenty-five (25) miles per hour.
3. Adverse Weather Day may include "dry-out" days, resulting from precipitation that occurs beyond the Anticipated Weather Delay Days for the month, only if there is a hindrance to site access or sitework and Contractor has taken all reasonable accommodations to avoid such hindrance; and, at a rate no greater than 1 make-up day for each precipitation day (or consecutive days) that total 1.0 inch or more of precipitation.
4. A Weather Delay Day may be counted by the Engineer, if adverse weather prevents work on the Project for fifty percent (50%) or more of the Contractor's normal scheduled work day and critical path construction activities were included in the day's schedule, including a weekend day or holiday approved by the Engineer with construction activity scheduled that day.
5. No additional compensation will be made for weather delays.

C. Contractor Documentation and Submittals

1. Organize claim to facilitate evaluation by calendar month and submit in accordance with the claims submittal requirements of the Contract Documents. Documentation is required for each Adverse Weather Day that results in a Weather Delay. Identify the number of days claimed for the month that exceeds the Schedule of Anticipated Adverse Weather Delays. Documentation must include:
  - a. Daily jobsite work logs showing which and to what extent critical path construction activities have been affected by adverse weather.
  - b. Daily weather data, obtained from the nearest NOAA weather station or other independently verified source approved by Engineer at beginning of the Project, to support claim for time extension. NOAA Global Historical Climatology Network (GHCN) Daily data may be obtained from the NOAA website at <http://www.ncdc.noaa.gov/cdo-web/search>.
2. If an extension of Contract Time is appropriate and approved by the Department, such extension will be made in accordance with the requirements of the Contract Documents.

#### 1.05 ADDITIONAL REQUIREMENTS FOR FEDERALLY FUNDED CONTRACTS

- A. This Contract is federally funded, contractor must comply with all the requirements of the federal agency providing the funds, inclusive FHWA.
- B. The provisions in this section shall apply to the (Contractor/Vendor/Consultant), its officers, agents, employees, subcontractors and suppliers. The (Contractor/Vendor/Consultant) shall incorporate the provisions in this Article in all subcontracts and all other agreements executed by the (Contractor/Vendor/Consultant) in connection with the performance of this contract.
- C. Miami-Dade County (MDC), a recipient of funds for the construction of highways and bridges, is required to ensure EEO contract compliance on all highway construction projects. Contractors who participate on MDC federally funded contracts in whole or in part are required to comply with certain Equal Employment Opportunity (EEO), Disadvantaged Business Enterprises (DBE), On-the-Job Training (OJT) and Wage Rate Special Provisions to be eligible for participation.
- D. When required by the contract documents the Contractor will make use of FDOT Material Testing Facilities, for material certifications and will comply with the submittal requirements of the Materials Acceptance and Certification System (MAC). See MAC below for more information.

#### 1.06 LAWS & REGULATIONS

- A. Contractor to follow all laws and regulations necessary to be in compliance with federal regulations.
  1. 23 CFR 230: Prescribes the policies, procedures, and guidance for equal opportunity on federal construction contracts.
  2. 23 CFR 230.111: Prescribes State agency requirements for an On-the-Job Training program for all Federal Aid Highway construction contracts. Other regulations governing State compliance programs include: Title VI of the Civil Rights Act of 1964, Federal Aid Required Contract Provisions, the Davis Bacon Act, the Copeland Act and the Contract Work Hours and Safety Standards Act., FHWA-1273, 23 CFR Part 230 and 49 CFR Part 26 authorize FDOT to take sanctions for the condition and state of noncompliance.

3. 23 CFR 140: Prescribes the policies, procedures, and guidance to develop, conduct, and administer supportive services assistance programs for minority, disadvantaged, and women business enterprises.
4. 28 CFR 35: Prohibits discrimination on the basis of disability by public entities.
5. 29 CFR 1630: Regulates implementation of the Equal Employment provisions of ADA.
6. 29 CFR, Part 3 (Copeland "Anti-Kickback" Law): Copeland "Anti-Kickback" Act (18 U.S.C. 874 and 40 U.S.C. 276c) - All contracts in excess of \$2,000 shall comply with the provision for compliance with the Copeland "Anti-Kickback" Act (18 U.S.C. 874), as supplemented by Department of Labor regulations (29 CFR Part 3, "Contractors and Subcontractors on Public Building or Public Work Financed in Whole or in Part by Loans or Grants from the United States"). The Act provides that each contractor or subcontractor shall be prohibited from inducing, by any means, any person employed in the construction, completion, or repair of public work, to give up any part of the compensation to which (s) he is otherwise entitled.
7. 40 USC 3141-4147 (Davis-Bacon Act of 1931 and as amended) Under the provisions of this Act, contractors or their subcontractors are to pay workers employed directly upon the site of the work no less than the locally prevailing wages and fringe benefits paid on projects of a similar character. The Davis-Bacon Act directs the Secretary of Labor to determine such local prevailing wage rates which can be found in a document named "General Decision Number".
8. 41 CFR 60: The purpose of the regulations in this part is to achieve the aims of Parts II, III, and IV of Executive Order 11246 for the promotion and insuring of equal opportunity for all persons, without regard to race, color, religion, sex, national origin, disability or status as a Vietnam era or special disabled veteran employed or seeking employment with government contractors or with contractors performing under federally assisted construction contracts. This legislation bans discrimination and requires contractors and subcontractors to take affirmative action to ensure that all individuals have an equal opportunity for employment. Contractor must comply with all the requirements of Presidential Executive Order 11246. Executive order can be found under Appendix C of these Supplementary Conditions and are being made part of these Contract Documents.
9. 41 CFR 60.1: Clarifies the existing requirement that a nonexempt construction contractor's total construction workforce is covered under 41 CFR 60 even though some employees may perform work on or nonfederal assisted contracts.
10. 40 USC Chapter 37, Sections 3701-3708 (Contract Work Hours and Safety Standards Act): Where applicable, all contracts awarded in excess of \$2,000 for construction contracts that involve the employment of mechanics or laborers shall include a provision for compliance with Subparts 102 and 107 of the Contract Work Hours and Safety Standards Act (40 U.S.C. 327-333), as supplemented by Department of Labor regulations (29 CFR Part 5). Under Subsection 102 of the Act, each contractor shall be required to compute the wages of every mechanic and laborer on the basis of a standard work week of 40 hours. Work in excess of the standard work week is permissible provided that the worker is compensated at a rate of not less than 1.5 times the basic rate of pay for all hours worked in excess of 40 hours in the work week. Subpart 107 of the Act is applicable to construction work and provides that no laborer or mechanic shall be required to work in surroundings or under working conditions, which are unsanitary, hazardous or dangerous.
11. 42 USC 12101: Regulates Equal Opportunity for individuals with disabilities.
12. 49 CFR 26: Regulates participation by Disadvantaged Business Enterprises.

13. Equal Pay Act of 1963: A law which requires equal pay between the sexes on jobs that is equal in skill, effort, and responsibility.
14. Equal Pay Act of 1976 (EPA): This legislation prohibits discrimination on account of sex in the payment of wages by employers engaged in commerce or in the production of goods for commerce.
15. Rehabilitation Act of 1973: Prohibits job discrimination because of disabilities and requires affirmative action to employ and advance in employment qualified individuals with disabilities who with reasonable accommodation can perform the essentials of a job.
16. Title I of the Americans with Disabilities Act (ADA) of 1990: Prohibits employment discrimination against qualified individuals with disabilities.
17. Title VI of the Civil Rights Act Of 1964: Prohibits discrimination on the basis of race, color, or national origin in all programs or activities receiving federal funding.
18. Title VII of the Civil Rights Act of 1964 (and as amended): Prohibits employment discrimination based on race, color, religion, sex and national origin.
19. Title VIII of the Civil Rights Act of 1964 (and as amended): The portion of the Civil Rights Act of 1968 (also known as the Fair Housing Act), as amended by the Housing and Community Development Act of 1974 and the Fair Housing Amendments Act of 1988, which prohibits discrimination in the sale, lease, rental, advertising, financing, and brokerage services of housing and real property based on race, color, religion, sex, national origin, disability, or familial status.
20. Veteran's preferences are not allowed under this contract.
21. Proprietary/Sole Sourced Materials are not allowed under this contract.

#### 1.07 CONTRACTOR RESPONSIBILITIES

- A. The prime contractor is responsible for compliance by any subcontractor or lower tier subcontractor. The contractor, subrecipient, subcontractor or rental agreement shall not discriminate on the basis of race, color, national origin, or sex in the performance of contracts.
- B. The contractor, subrecipient or subcontractor shall not discriminate on the basis of race, color, national origin, or sex in the performance of this contract. The contractor shall carry out applicable requirements of 49 CFR Part 26 in the award and administration of DOT-assisted contracts. Failure by the contractor to carry out these requirements is a material breach of this contract, which may result in the termination of this contract or such other remedy as the recipient deems appropriate.
- C. The prime contractor shall be responsible for compliance by any subcontractor or lower tier subcontractor with the Required Contract Provisions. In the event a prime contractor defaults on a contract and their contract compliance data is incomplete or incorrect, the Resident Compliance Specialist will proceed with all noncompliance communications and actions such that the surety company and/or the successor contractor are fully aware of the conditions. A surety company is exempt from contract compliance reporting requirements but is responsible for ensuring that the successor contractor carries out the requirements.
- D. Authority of the U.S. Comptroller General.

1. The U.S. Comptroller General and his representatives the authority:
2. To examine any records of the Contractor or any of its subcontractors, or any State or Local agency administering such contract, that directly pertain to, and involve transactions relating to, the contract or subcontract; and
3. to interview any officer or employee of the Contractor or any of its subcontractors, or of any State or Local government agency administering the Contract, regarding such transactions.

E. Authority of the U.S. Inspector General.

1. The Inspector General or any representatives has the authority to examine any records or interview any employee or officers working on this Contract. The Contractor is advised that representatives of the Inspector General have the authority to examine any record and interview any employee or officer of the Contractor, its subcontractors or other firms working on this Contract. Nothing in this Section shall be interpreted to limit or restrict in any way any existing authority of an Inspector General.
2. County and the Contractor agree to comply with s.20.055(5), Florida Statutes, and to incorporate in all subcontracts the obligation to comply with s.20.055(5), Florida Statutes.
  - a. It is the duty of every state officer, employee, agency, special district, board, commission, contractor, and subcontractor to cooperate with the inspector general in any investigation, audit, inspection, review, or hearing pursuant to this section.

F. Withholding payment for failure to comply with federal aid requirements.

1. The Department will withhold progress payments from the Contractor for failure to comply with the requirements of this Article.

G. Costs for Compliance with federal aid requirements

1. The costs for complying with federal aid requirements, including the cost of preparing and submitting Employment Reports, are incidental to the Contract. The Contractor shall include all related costs in the unit Bid prices of the Contract.

H. Certification of Inclusion of FHWA-1273

1. The prime contractor is responsible for ensuring that FHWA 1273, Required Contract Provisions for Federal Aid Construction, is inserted, in its entirety, in all contractor agreements including each subcontract and any lower tier subcontract or purchase order that may in turn be made. The Required Contract Provisions of FHWA 1273 is located under Appendix B of these Supplementary Conditions and it is being made part of these Contract Documents. The FHWA-1273 Electronic version, dated May 1, 2012 is posted on the FDOT's website at the following URL address: [https://fdotwww.blob.core.windows.net/sitefinity/docs/default-source/programmanagement/implemented/urlinspecs/files/fhwa1273.pdf?sfvrsn=1cd7961f\\_12](https://fdotwww.blob.core.windows.net/sitefinity/docs/default-source/programmanagement/implemented/urlinspecs/files/fhwa1273.pdf?sfvrsn=1cd7961f_12).
2. Take responsibility to obtain this information and comply with all requirements posted on this website up through five calendar days before the opening of bids.
3. If the FDOT website cannot be accessed, contact FDOT Department's Specifications Office Web Coordinator at (850) 414-4101.



4. Submit to the Engineer a complete and executed Certification of Inclusion of FHWA-1273 form, included in Section 2 (Solicitation Forms) of these Contract Documents, for each subcontractor, supplier, or Rental Company, including every lower tier provider, used in the performance of this Contract. Contractor is responsible for the compliance of all required Contract Provisions by each subcontractor, lower tier subcontractor, or supplier.

I. Exclusions

1. Contractor Purchased Equipment for State or Local Ownership pursuant to 23 CFR 140, 49 CFR Part 18, and 49 CFR Section 18.3; not allowed in this Contract.
2. Public Agencies in Competition with the Private Sector pursuant to 23 CFR 635.112 (e); not allowed in this Contract.
3. Publicly-Owned Equipment pursuant to the requirements of 23 CFR 635.106; not allowed in this Contract.
4. Salvage Credits pursuant to the requirements of 49 CFR 18.36; no salvage credit shall be provided.
5. State or Local Preference pursuant to the requirements of 23 CFR 635.117; not allowed in this Contract.
6. Foreign Contractor and Supplier Restriction pursuant to the requirements of 49 CFR 30; not allowed in this Contract.
7. State (Florida or other)-produced materials, 23 CFR 635.409 Preference programs mandating materials purchasing requirements or restrictions are not allowed under this contract
8. State/Local owned/Furnished/Designated materials, 23 CFR 635.407 Tax saving programs are not allowed under this contract.
9. Comply with Section 20.055(5), Florida Statutes, and incorporate in all subcontracts the obligation to comply with Section 20.055(5), Florida Statutes.
10. Owner Force Account contracting pursuant to 23 CFR 635B under 635.205; not allowed in this Contract.
11. Veteran's preferences are not allowed under this contract.
12. Proprietary/Sole Sourced Materials are not allowed under this contract.
13. As stated on 23 CFR 635.127 and Section 1.2.7 of FDOT CPAM, Incentive/Disincentive Clauses, are not applicable to this contract.
14. As stated on 23 CFR 635.117, Indian Preference on Federal-Aid Projects, is not applicable to this contract.

J. Labor, Employment, and Convict Produced Materials

1. Labor and employment.
  - a. Pursuant to 23 CFR 635.417:

- 1) No construction work shall be performed by convict labor at the work site or within the limits of any Federal-aid highway construction project from the time of award of the contract or the start of work on force account until final acceptance of the work by the STD unless it is labor performed by convicts who are on parole, supervised release, or probation.
- 2) No procedures or requirement shall be imposed by any State which will operate to discriminate against the employment of labor from any other State, possession or territory of the United States, in the construction of a Federal-aid project.
- 3) The selection of labor to be employed by the contractor on any Federal-aid project shall be by the contractor without regard to race, color, religion, sex, national origin, age, or handicap and in accordance with 23 CFR part 230, 41 CFR part 60 and Exec. Order No. 11246 (Sept. 24, 1965), 3 CFR 339 (1964-1965), as amended.
- 4) The advertisement or call for bids on any contract for the construction of a project located on the Federal-aid system either shall include the minimum wage rates determined by the Secretary of Labor to be prevailing on the same type of work on similar construction in the immediate locality or shall provide that such rates are set out in the bidding documents and shall further specify that such rates are a part of the contract covering the project.

1.08 TITLE VI ASSURANCE – DOT 1050.2A, APPENDIX A AND APPENDIX E.

A. Appendix A:

1. During the performance of this Contract, the Contractor, for itself, its assignees and successors in interest (hereinafter referred to as the “Contractor”) agrees as follows:
  - a. Compliance with Regulations: The Contractor shall comply with the Regulations relative to nondiscrimination in Federally-assisted programs of the US Department of Transportation (hereinafter, “USDOT”) Title 49, Code of Federal Regulations, Part 21, as they may be amended from time to time, (hereinafter referred to as the Regulations), which are herein incorporated by reference and made a part of this Contract.
  - b. Nondiscrimination: The Contractor, with regard to the work performed by it during the Contract, shall not discriminate on the basis of race, color, national origin or sex in the selection and retention of sub-contractors, including procurements of materials and leases of equipment. The Contractor shall not participate either directly or indirectly in the discrimination prohibited by Section 21.5 of the Regulations, including employment practices when the Contract covers a program set forth in Appendix B of the Regulations.
  - c. Solicitations for subcontractors, including procurements of materials and equipment: In all solicitations either by competitive bidding or negotiation made by the Contractor for work to be performed under subcontract, including procurements of materials or leases of equipment, each potential subcontractor or supplier shall be notified by the Contractor of the Contractor’s obligations under this contract and the Regulations relative to nondiscrimination on the basis of race, color, national origin, or sex.
  - d. Information and Reports: The Contractor shall provide all information and reports required by the Regulations or directives issued pursuant thereto, and shall permit access to its books, records, accounts, other sources of information and its facilities as may be determined by the Florida Department of Transportation or the Federal Highway Administration, Federal Transit Administration, Federal Aviation Administration, and Federal Motor Carrier Safety Administration to be pertinent to ascertain compliance with such Regulations, order and instructions. Where any information required of a Contractor is in the exclusive possession of another who fails or refuses to furnish this information the

Contractor shall so certify to the Florida Department of Transportation, or the Federal Highway Administration, Federal Transit Administration, Federal Aviation Administration, or Federal Motor Carrier Safety Administration as appropriate, and shall set forth what efforts it has made to obtain the information.

- e. Sanctions for Noncompliance: In the event of the Contractor's noncompliance with the nondiscrimination provisions of this Contract, the Florida Department of Transportation shall impose such Contract sanctions as it or the Federal Highway Administration, Federal Transit Administration, Federal Aviation Administration, or Federal Motor Carrier Safety Administration may determine to be appropriate, including, but not limited to:
  - 1) Withholding of payments to the Contractor under the Contract until the Contractor complies, or
  - 2) Cancellation, termination or suspension of the Contract, in whole or in part.
- f. Incorporation of Provisions: The Contractor shall include the provisions of this appendix in every subcontract, including procurements of materials and leases of equipment, unless exempt by the Regulations, or directives issued pursuant thereto. The Contractor shall take such action with respect to any subcontract or procurement as the Florida Department of Transportation or the Federal Highway Administration, Federal Transit Administration, Federal Aviation Administration, or Federal Motor Carrier Safety Administration may direct as a means of enforcing such provisions including sanctions for noncompliance, provided, however, that, in the event a Contractor becomes involved in, or is threatened with, litigation with a subcontractor or supplier as a result of such direction, the Contractor may request the Florida Department of Transportation to enter into such litigation to protect the interests of the Florida Department of Transportation, and, in addition, the Contractor may request the United States to enter into such litigation to protect the interests of the United States.

B. Appendix E:

- 1. During the performance of this Contract, the Contractor, for itself, its assignees, and successors in interest (hereinafter referred to as the "Contractor" agrees to comply with the following non-discrimination statutes and authorities; including but not limited to:
  - a. Title VI of the Civil Rights Act of 1964 (42 U.S.C. § 2000d et seq., 78 stat. 252), (prohibits discrimination on the basis of race, color, national origin); and 49 CFR Part 21;
  - b. The Uniform Relocation Assistance and Real Property Acquisition Policies Act of 1970, (42 U.S.C. § 4601), (prohibits unfair treatment of persons displaced or whose property has been acquired of Federal or Federal-aid programs and projects);
  - c. Federal-Aid Highway Act of 1973, (23 U.S.C § 324 et seq.), (prohibits discrimination on the basis of sex);
  - d. Section 504 of the Rehabilitation Act of 1973 (29 U.S.C. § 794 et seq.), as amended, (prohibits discrimination on the basis of disability); and 49 CFR Part 27;
  - e. The Age Discrimination Act of 1975, as amended, (42 U.S.C. § 6101 et seq.), (prohibits discrimination on the basis of age);
  - f. Airport and Airway Improvement Act of 1982, (49 U.S.C. 471, Section 47123), as amended, (prohibits discrimination based on race, creed, color national origins or sex);
  - g. The Civil Rights Restoration Act of 1987 (PL 100-209), (Broadened the scope, coverage and applicability of Title VI of the Civil Rights Act of 1964, The Age Discrimination Act of 1975 and Section 504 of the Rehabilitation Act of 1973, by expanding the definition of the terms "programs or activities" to include all of the programs or activities of the Federal-aid

recipients, sub-recipients and contractors, whether such programs or activities are Federally funded or not);

- h. Titles II and III of the Americans with Disabilities Act, which prohibits discrimination on the basis of disability in the operation of public entities, public and private transportation systems, places of public accommodation, and certain testing entities (42 U.S.C. §§ 12131 – 12189) as implemented by Department of Transportation regulations at 49 C.F.R. parts 37 and 38;
- i. The Federal Aviation Administration's Non-discrimination statute (49 U.S.C. § 47123) (prohibits discrimination on the basis of race, color, national origin, and sex);
- j. Executive Order 12898, Federal Actions to Address Environmental Justice in Minority Populations and Low-Income Populations, which ensures non-discrimination against minority populations by discouraging programs, policies, and activities with disproportionately high and adverse human health or environmental effects on minority and low-income populations;
- k. Executive Order 13166, Improving Access to Services for Persons with Limited English Proficiency, and resulting agency guidance, national origin discrimination includes discrimination because of limited English proficiency (LEP). To ensure compliance with Title VI, you must take reasonable steps to ensure that LEP persons have meaningful access to your programs (70 Fed. Reg. at 74087 to 74100);
- l. Title IX of the Education Amendments of 1972, as amended, which prohibits discrimination based on sex in education programs, or activities (20 U.S.C. 1681 et seq.).

#### 1.09 ADDITIONAL SBE-CONST CONTRACT MEASURE REQUIREMENTS

- A. As per Miami-Dade County Ordinance No.'s 97-52 and 97-158; A.O. 3-22, a Small Business Enterprise - Construction (SBE-CONST) Contract Measure has not been established for this Project. Due to the funding source of this contract, a local preference is not allowed, however this project contains a Disadvantaged Business Enterprise (DBE) race neutral aspirational goal of 10.65% percent.

#### 1.10 DISADVANTAGED BUSSINESS ENTERPRISE PROGRAM

- A. In accordance with 49 CFR 26.13 (b), the Contractor (and each subcontract the prime contractor signs with a subcontractor) must include the following assurance: The Contractor, sub-recipient or subcontractor shall not discriminate on the basis of race, color, national origin, or sex in the performance of this contract. The Contractor shall carry out applicable requirements of 49 CFR Part 26 in the award and administration of DOT-assisted Contracts. Failure by the Contractor to carry out these requirements is a material breach of this Contract, which may result in the termination of this Contract or such other remedy as the recipient deems appropriate, which may include, but is not limited to,

- 1. Withholding monthly progress payments;
- 2. Assessing sanctions;
- 3. Liquidated damages; and/or
- 4. Disqualifying the Contractor from future bidding as non-responsible.

- B. DBE Records and Reports:

1. Submit the following through the Equal Opportunity Compliance System:
  - a. DBE Commitments - at or before the Pre-Construction Conference.
  - b. Report monthly, through the Equal Opportunity Compliance System on the Department's Website, actual payments (including retainage) made to DBEs for work performed with their own workforce and equipment in the area in which they are certified. Report payments made to all DBE and Minority Business Enterprise (MBE) subcontractors and DBE and MBE construction material and major suppliers.
  - c. The Equal Opportunity Office will provide instructions on accessing this system. Develop a record keeping system to monitor DBE affirmative action efforts which include the following:
    - 1) The procedures adopted to comply with the DBE Program;
    - 2) The number of subordinated Contracts on projects awarded to DBEs;
    - 3) The dollar value of the Contracts awarded to DBEs;
    - 4) The percentage of the dollar value of all subordinated Contracts awarded to DBEs as a percentage of the total Contract amount;
    - 5) A description of the general categories of Contracts awarded to DBEs; and
    - 6) The specific efforts employed to identify and award Contracts to DBEs.
  - d. Upon request, provide the records to the County for review. Maintain all such records for a period of five years following acceptance of final payment and have them available for inspection by the County, FDOT and the Federal Highway Administration.

C. Counting DBE Participation and Commercially Useful Functions:

1. 49 CFR Part 26.55 specifies when DBE credit shall be awarded for work performed by a DBE. DBE credit can only be awarded for work actually performed by DBEs themselves for the types of work for which they are certified. When reporting DBE Commitments, only include the dollars that a DBE is expected to earn for work they perform with their own workforce and equipment. Update DBE Commitments to reflect changes to the initial amount that was previously reported or to add DBEs not initially reported.
2. When a DBE participates in a contract, the value of the work is determined in accordance with 49 CFR Part 26.55, for example:
  - a. The County will count only the value of the work performed by the DBE toward DBE goals. The entire amount of the contract that is performed by the DBE's own forces (including the cost of supplies, equipment and materials obtained by the DBE for the contract work) will be counted as DBE credit.
  - b. The County will count the entire amount of fees or commissions charged by the DBE firm for providing a bona fide service, such as professional, technical, consultant, or managerial services or for providing bonds or insurance specifically required for the performance of a County-assisted contract, toward DBE goals, provided that the County determines the fees to be reasonable and not excessive as compared with fees customarily followed for similar services.
  - c. When the DBE subcontracts part of the work of its contract to another firm, the County will count the value of the subcontracted work only if the DBE's subcontractor is itself a DBE. Work that a DBE subcontracts to a non-DBE firm does not count toward DBE goals.

- d. When a DBE performs as a participant in a joint venture, the County will count the portion of the dollar value of the contract equal to the distinct, clearly defined portion of the work the DBE performs with its own forces toward DBE goals.
  - e. The Contractors shall ensure that only expenditures to DBEs that perform a commercially useful function (CUF) in the work of a contract may be counted toward the voluntary DBE goal.
  - f. A DBE performs a commercially useful function when it is responsible for execution of the work of the contract and is carrying out its responsibilities by actually performing, managing, and supervising the work involved. To perform a commercially useful function, the DBE must also be responsible, with respect to materials and supplies used on the contract, for negotiating price, determining quality and quantity, ordering the material, and installing (where applicable) and paying for the material itself.
  - g. Contractors wishing to use joint checks involving DBE credit must provide written notice to the FDOT District Contract Compliance Office prior to issuance of the joint check. The Contractor must also provide a copy of the notice to the DBE subcontractor and maintain a copy with the project records.
  - h. To determine whether a DBE is performing a commercially useful function, the County will evaluate the amount of work subcontracted, industry practices, whether the amount the firm is to be paid under the contract is commensurate with the work it is actually performing and the DBE credit claimed for its performance of the work, and other relevant factors.
  - i. A DBE does not perform a commercially useful function if its role is limited to that of an extra participant in a transaction, contract, or project through which funds are passed in order to obtain the appearance of DBE participation.
  - j. If a DBE does not perform or exercise responsibility for at least 30% of the total cost of its contract with its own workforce, or if the DBE subcontracts a greater portion of the work of a contract than would be expected on the basis of normal industry practice for the type of work involved, the DBE has not performed a commercially useful function.
- D. For further questions and/or concerns, please contact Mr. Stan Ford, FDOT District Six Compliance Manager with the details at: [Stan.Ford@dot.state.fl.us](mailto:Stan.Ford@dot.state.fl.us) or at (305) 640-7459.
- E. All forms to be submitted can be found under Section 2 of these Contract Documents. The County Small Business Development Division (SBD) Project Worksheet is located under Appendix D of these Supplementary Conditions and it is being made part of these Contract Documents.
- F. Prompt Payments and Retainage:
1. In addition to Miami-Dade County Sec. 2-8.1.4. Sherman S. Winn Prompt Payment Ordinance and Administrative Order No.: 3-19 Prompt Payment, contractors, subcontractors and the County must also meet the requirements of Title 49 CFR part 26.29 and 26.37 and the Florida Prompt Pay Act. Prime contractors must pay subcontractors, including DBE'S, for satisfactory performance of their contracts no later than 30 calendar days after the date on which the payment request or a "*proper invoice*" is stamped received. Further, the prime contractor will return retainage payments to the subcontractor, including DBE firms, within 30 days of the subcontractor's satisfactory completion of work.
  2. Proper Invoice means an invoice which conforms to the present requirements of the County's finance system, which includes the issuance of a valid purchase order or contract as well as applicable change orders or amendments, and any rules promulgated from time to time by Administrative Order of the Mayor. A proper invoice must include a statement by the vendor/contractor waiving claims for extra direct and indirect costs or time associated with work preceding the date of the invoice, or a statement in sufficient detail containing all rights reserved

for work already performed. All present requirements or future rules pertaining to the execution of a proper invoice are available to contractors at the pre-construction meeting.

3. In any case in which an improper invoice is submitted by a contractor, the County will, within ten (10) days after the improper invoice is received by it, notify the contractor that the invoice is improper and indicate what corrective action on the part of the vendor is needed to make the invoice proper.
4. In the event a dispute occurs between the contractor and the County concerning payment of an invoice, such disagreement shall be resolved not later than forty-five (45) days after the date on which the improper invoice was received by the County, and shall be concluded by final written decision of the Mayor or his or her designee(s), not later than sixty (60) days after the date on which the improper invoice was received by the County.
5. If the dispute is resolved in favor of the contractor, then interest shall begin to accrue as of the original date the payment became due.
6. All payments due from the County, and are not made by the appropriate due date as described above, shall bear interest from thirty (30) days after the appropriate due date at the rate of one (1) percent per month on the unpaid balance. One (1) month shall constitute a period beginning on any day of a month and ending on the same day of the following month. Any overdue period of less than one (1) month shall be considered as one (1) month in computing interest. Unpaid interest shall compound monthly.
7. The vendor must be responsible for preparing and delivering an invoice to the County for any interest accrued in order to receive the interest payment. The invoice must include the following:
  - a. Date proper invoice received by County, its applicable invoice number and amount.
  - b. Date punch list was completed.
  - c. Date and corresponding reference number of applicable purchase order, requisition or contract.
  - d. Payment due date.
  - e. Date interest commences.
  - f. Interest due at one percent per month on unpaid balance.
8. Contractor may not hold retainage from its subcontractors and is required to return any retainage payments to those subcontractors within 30 days after the subcontractor's work related to this contract is satisfactorily completed or within 30 days after incremental acceptance of the subcontractor's work by the County and contractor's receipt of the partial retainage payment related to the subcontractor's work, whichever comes first.

#### 1.11 MATERIALS ACCEPTANCE AND CERTIFICATION SYSTEM (MAC)

- A. When required by the Contract Documents and as per request of the funding administrator, Contractor must comply with the reporting requirements of the MAC system.
- B. Contractor is required to create a non-standard Job Guide Schedule (JGS) in MAC for the materials being certified by the FDOT. Once created, the non-standard JGS assigns the appropriate materials for County projects that don't have pay items entered in the FDOT construction management database.

- C. When the County employs a consultant (CEI firm) for materials testing:
1. The CEI firm will need MAC access to make for data entry and data review of verification, independent verification and resolution sample and test data entry.
  2. The CEI firm will need personnel assigned the MAC system role of Project Administrator to:
    - a. Review the JGS entries for correctness and completeness.
    - b. Accept or reject the Contractor QC Plan.
    - c. Finalize project samples.
    - d. Create comparison packages, if applicable.
    - e. Respond to Materials Certification Review findings.
    - f. Process Materials Acceptance Resolution (MAR) issues.
- D. When the County performs the CEI materials testing duties directly, the County personnel will need MAC system role of Project Administrator to complete all of the items listed above under C.2.
1. Contact the local MAC District Application Coordinator for additional information if access and training is needed the Mac contact Information can be found at <http://www.fdot.gov/materials/administration/resources/contacts/mac.shtm>
  2. Training can be found here at FDOT, State Materials Office - MAC Development Training Information at the following link: <http://www.fdot.gov/materials/mac/training/index.shtm>
  3. Access instructions can be found at: <http://www.fdot.gov/materials/mac/access/index.shtm>
  4. County projects not requiring FDOT Materials Certification will not be processed in MAC. The MAC process is very complex and in many cases not applicable to local agency specific materials certification processes. For further information or clarification, please contact Lorraine Moyle, State Local Program Administrator, FDOT, Office of Program Management, 605 Suwanee Street, M.S. 75; Tallahassee, FL 32399-0450. Phone (850) 414-4383. E-mail: [Lorraine.moyle@dot.state.fl.us](mailto:Lorraine.moyle@dot.state.fl.us).

#### 1.12 ON-THE-JOB TRAINING REQUIREMENTS

- A. Contractor to provide On-The-Job Training as part of the Contractor's equal employment opportunity affirmative action program aimed at developing full journeymen in the type of trade or job classification involved in the work. In the event the Contractor subcontracts a portion of the contract work, it shall determine how many, if any, of the trainees are to be trained by the subcontractor provided, that the Contractor shall retain the primary responsibility for meeting the training requirements imposed by this Article.
- B. Ensure that, when feasible, 25% of trainees in each occupation are in their first year of training. The Contractor shall incorporate the requirements of this Article into such subcontract.
- C. The number of trainees will be estimated on the number of calendar days of the contract, the dollar value, and the scope of work to be performed. The trainee goal will be finalized at a Post-Preconstruction Trainee Evaluation Meeting and the goal will be distributed among the work classifications based on the following criteria:
  1. Determine the number of trainees on Federal Aid Contract:



- a. No trainees will be required for contracts with a Contract Time allowance of less than 275 calendar days.
- b. If the Contract Time allowance is 275 calendar days or more, the number of trainees shall be established in accordance with the following chart:

Estimated Contract Amount	Trainees Required
\$2,000,000 or less	0
Over \$2,000,000 to \$4,000,000	2
Over \$4,000,000 to \$6,000,000	3
Over \$6,000,000 to \$12,000,000	5
Over \$12,000,000 to \$18,000,000	7
Over \$18,000,000 to \$24,000,000	9
Over \$24,000,000 to \$31,000,000	12
Over \$31,000,000 to \$37,000,000	13
Over \$37,000,000 to \$43,000,000	14
Over \$43,000,000 to \$49,000,000	15
Over \$49,000,000 to \$55,000,000	16
Over \$55,000,000 to \$62,000,000	17
Over \$62,000,000 to \$68,000,000	18
Over \$68,000,000 to \$74,000,000	19
Over \$74,000,000 to \$81,000,000	20
Over \$81,000,000 to \$87,000,000	21
Over \$87,000,000 to \$93,000,000	22
Over \$93,000,000 to \$99,000,000	23
Over \$99,000,000 to \$105,000,000	24
Over \$105,000,000 to \$112,000,000	25
Over \$112,000,000 to \$118,000,000	26
Over \$118,000,000 to \$124,000,000	27
Over \$124,000,000 to \$130,000,000	28
Over \$130,000,000 to *	

Estimated Contract Amount	Trainees Required
*One additional trainee per \$6,000,000 of estimated Construction Contract amount over \$130,000,000	

- D. Further, if the Contractor or subcontractor requests to utilize banked trainees as discussed later in this Article, a Banking Certificate will be validated at this meeting allowing credit to the Contractor for previously banked trainees. Banked credits of prime Contractors working as Subcontractors may be accepted for credit. The Contractor’s Project Manager, the Construction Project Engineer and the FDOT’s District Contract Compliance Manager will attend this meeting. Within ten days after the Post-Preconstruction Training Evaluation Meeting, the Contractor shall submit to the FDOT for approval an On-The-Job Training Schedule indicating the number of trainees to be trained in each selected classification and the portion of the Contract Time during which training of each trainee is to take place. This schedule may be subject to change if any of the following occur:
1. When a start date on the approved On-The-Job Training Schedule has been missed by 14 or more days;
  2. When there is a change in previously approved classifications;
  3. When replacement trainees are added due to voluntary or involuntary termination
- E. The revised schedule will be resubmitted to and approved by the FDOT’s District Contract Compliance Manager.
- F. The following criteria will be used in determining whether or not the Contractor has complied with this Section as it relates to the number of trainees to be trained:
1. Credit will be allowed for each trainee that is both enrolled and satisfactorily completes training on this Contract. Credit for trainees, over the established number for this Contract, will be carried in a “bank” for the Contractor and credit will be allowed for those surplus trainees in subsequent, applicable projects. A “banked” trainee is described as an employee who has been trained on a project, over and above the established goal, and for which the Contractor desires to preserve credit for utilization on a subsequent project.
  2. Credit will be allowed for each trainee that has been previously enrolled in the FDOT’s approved training program on another contract and continues training in the same job classification and completes their training on a different contract.
  3. Credit will be allowed for each trainee who, due to the amount of work available in their classification, is given the greatest practical amount of training on the contract regardless of whether or not the trainee completes training.
  4. Credit will be allowed for any training position indicated in the approved On The Job Training Schedule, if the Contractor can demonstrate that made a good faith effort to provide training in that classification was made.
  5. No credit will be allowed for a trainee whose employment by the Contractor is involuntarily terminated unless the Contractor can clearly demonstrate good cause for this action.
- G. Training and upgrading of minorities, women and economically disadvantaged persons toward journeyman status is a primary objective of this Article. Accordingly, the Contractor shall make every effort to enroll minority trainees and women (e.g., by conducting systematic and direct recruitment through public and private sources likely to yield minority and women trainees) to the

extent such persons are available within a reasonable area of recruitment. If a non-minority male is enrolled into the On-The-Job Training Program, the On-The-Job Training Notification of Personnel Action Form notifying the FDOT District Contract Compliance Manager of such action shall be accompanied by a disadvantaged certification or a justification for such action acceptable to the FDOT Department's District Contract Compliance Manager. The Contractor will be given an opportunity and will be responsible for demonstrating the steps that it has taken in pursuance thereof, prior to a determination as to whether the Contractor is in compliance with this Section. This training is not intended, and shall not be used, to discriminate against any applicant for training, whether a minority, woman or disadvantaged person.

- H. No employee shall be employed as a trainee in any classification in which they have successfully completed a training course leading to journeyman status, or have been employed as a journeyman. The Contractor may satisfy this requirement by including appropriate questions in the employee application or by other suitable means. Regardless of the method used, the Contractor's records should document the findings in each case.
  - 1. The minimum length and type of training for each classification will be as established at the Post-Preconstruction Trainee Evaluation Meeting and approved by FDOT. Graduation to journeyman status will be based upon satisfactory completion of a Proficiency Demonstration set up at the completion of training and established for the specific training classification, completion of the minimum hours in a training classification range, and the employer's satisfaction that the trainee does meet journeyman status in the classification of training. Upon reaching journeyman status, the following documentation must be forwarded to FDOT District Contract Compliance Office:
    - a. Trainee Enrollment and Personnel Action Form
    - b. Proficiency Demonstration Verification Form indicating completion of each standard established for the classification signed by representatives of both the Contractor and the Department.
- I. The County and the Contractor shall establish a program that is tied to the scope of the work in the project and the length of operations providing it is reasonably calculated to meet the equal employment opportunity obligations of the Contractor and to qualify the average trainee for journeyman status in the classifications concerned, by at least, the minimum hours prescribed for a training classification. Furthermore, apprenticeship programs registered with the U.S. Department of Labor, Bureau of Apprenticeship and Training, or with a State apprenticeship agency recognized by the Bureau and training programs approved but not necessarily sponsored by the U.S. Department of Labor, Manpower Administration, Bureau of Apprenticeship and Training shall also be considered acceptable provided it is being administered in a manner consistent with the equal employment obligations of Federal Aid highway construction contract. Approval or acceptance of a training schedule shall be obtained from FDOT prior to commencing work on the classifications covered by the program.
- J. A voluntary On-The-Job Training Program is available to a Contractor which has been awarded a state funded project. Through this program, the Contractor will have the option to train employees on state funded projects for "banked credit" as discussed previously in this provision, to be utilized on subsequent Federal Aid Projects where training is required. Those Contractors availing themselves of this opportunity to train personnel on state funded projects and bank trainee hours for credit shall comply with all training criteria set forth in this Article for Federal Aid Projects; voluntary banking may be denied by FDOT if staff is not available to monitor compliance with the training criteria.
- K. It is the intention of these provisions that training is to be provided in the construction crafts rather than clerk-typists or secretarial type positions. Training is permissible in lower level management

positions such as office engineers, estimators, etc., where the training is oriented toward construction applications. Training in the laborer classifications, except Common/General Laborer, may be permitted provided that significant and meaningful training is provided and approved by FDOT District Contract Compliance Office.

- L. When approved in advance by FDOT District Contract Compliance Manager, credit will be given for training of persons in excess of the number specified herein under the current contract or a Contractor will be allowed to bank trainees who have successfully completed a training program and may apply those trainees to a training requirement in subsequent project(s) upon approval of FDOT's District Contract Compliance Manager. This credit will be given even though the Contractor may receive training program funds from other sources, provided such other source do not specifically prohibit the Contractor from receiving other form of compensation. Offsite training is permissible as long as the training is an integral part of an approved training program and does not compromise a significant part of the overall training. Credit for offsite training indicated above may only be made to the Contractor when it does one or more of the following and the trainees are concurrently employed on a Federal Aid Project:
  - 1. Contributes to the cost of the training,
  - 2. Provides the instruction to the trainee,
  - 3. Pays the trainee's wages during the offsite training period.
- M. The Contractor shall compensate the trainee at no less than the laborer rate established in the Contract at the onset of training. The compensation rate will be increased to the journeyman's wage upon graduation from the training program for the remainder of the time the trainee works in the classification in which they were trained.
- N. The Contractor shall furnish the trainee a copy of the program they will follow in providing the training. The Contractor shall provide each trainee with a certification showing the type and length of training satisfactorily completed. The Contractor shall enroll a trainee in one training classification at a time to completion before the trainee can be enrolled in another classification on the same project.
- O. The Contractor shall maintain records to document the actual hours each trainee is engaged in training on work being performed as a part of this Contract.
- P. The Contractor shall submit to FDOT District Contract Compliance Manager a copy of an On-The-Job Training Notification of Personnel Action form no later than seven days after the effective date of the action when the following actions occur: a trainee is transferred on the project, transferred from the project to continue training on another contract, completes training, is upgraded to journeyman status or voluntarily terminates or is involuntary terminated from the project.
- Q. The Contractor shall furnish to FDOT District Contract Compliance Manager a copy of a Monthly Time Report for each trainee. The Monthly Time Report for each month shall be submitted no later than the tenth day of the subsequent month. The Monthly Time Report shall indicate the phases and sub-phases of the number of hours devoted to each proficiency.
- R. Highway or Bridge Carpenter Helper, Mechanic Helper, Rodman/Chainman, and Timekeeper classifications will not be approved for the On-The-Job Training Program.
- S. The number of trainees may be distributed among the work classifications on the basis of the Contractor's needs and the availability of journeymen in the various classifications within a reasonable area of recruitment.

- T. The Contractor will have fulfilled the responsibilities of this Specification when acceptable training has been provided to the trainee as specified above.

#### 1.13 COMMUNITY WORKFORCE PROGRAM

- A. In accordance with Miami-Dade County Code §2-1701 and amended by Ordinance No. 13-66 the Community Workforce Program (CWP) does not apply for this Project.
- A. Due to the funding source of this contract, no procedures or requirement will be imposed by Miami-Dade County which will operate to discriminate against the employment of labor from any other State, possession or territory of the United States, in the construction of this Federal-aid project in order to be in compliance with the use of Local Hiring Preferences as stated under 23 USC 112, 23 CFR 635.117(b), and Headquarters memorandum - "Local Hiring Preferences," April 20, 1994.

#### 1.14 CLEARINGHOUSE FOR POSTING NOTICE OF JOB OPPORTUNITIES

- A. The subject project is federally funded, therefore Clearinghouse for Posting Notice of Job Opportunities is not applicable.

#### 1.15 RESIDENTS FIRST TRAINING AND EMPLOYMENT PROGRAM COMPLIANCE

- A. The subject project is federally funded, therefore RFTE program is not applicable.

#### 1.16 EMPLOY MIAMI-DADE PROGRAM

- A. The subject project is federally funded, therefore Employ Miami-Dade program is not applicable.

#### 1.17 ACCEPTANCE TESTS

- A. Replace Article 2.89 of the CICC 7360-0/08 Miscellaneous Construction Contract with the following:
- B. When Contractor informs Engineer that the Work is ready for inspection and testing, Engineer may request, from a County approved laboratory, the tests necessary to confirm that the required material, compaction, or work specifications are met. If the results of the tests reveal that the applicable specifications have not been met, Contractor, without additional compensation, must perform, to the satisfaction of Engineer, all work necessary to meet the applicable specifications and is responsible for the costs of all re-testing required by Engineer and the Contract Documents.
- C. The Department will pay the laboratory for the first test (pass or fail); any re-testing will be the responsibility of Contractor. The Department will only pay for re-testing when authorized, in writing, by Engineer.
- D. Contractor must comply with the conditions of the agreement between Miami-Dade County and Laboratory.

#### 1.18 CHANGE ORDER PROCEDURES AND BASIS FOR PAYMENT

- A. Extra Work shall result in an equitable adjustment (increase or decrease) to the applicable RPQ representing the reasonable cost or the reasonable financial savings related to the change in Work. Extra Work may also result in an equitable adjustment in the RPQ schedule for performance for both the Extra Work and any other Work affected by the Extra Work.
- B. The County shall initiate the Extra Work procedure by a notice to Contractor outlining the proposed Extra Work. Upon receipt of the notice to proceed with the Extra Work, the Contractor is required to immediately start the Extra Work. The Contractor is required to obtain permission for an extension to start the Extra Work if it is beyond the Contractor's ability to start within the allotted timeframe.
- C. The Contractor is required to provide the Project Manager with a detailed Change Order Proposal, if an Owner's Representative has been identified, which shall include requested revisions to the Contract, including but not limited to adjustments in the RPQ price and schedules for performance for the applicable RPQ. The change to the RPQ shall not exceed \$100,000 or 10% of original RPQ, whichever is less. The Contractor is required to provide sufficient data in support of the cost proposal demonstrating reasonableness. In furtherance of this obligation, the County may require that the Contractor submit any or all of the following: a cost breakdown of material costs, labor costs, labor rates by trade, and Work classification and overhead rates in support of Contractor's Change Order Proposal. The Contractor's Change Order Proposal must include any schedule revisions and an explanation of the cost and schedule impact of the extra Work on the project. If the Contractor fails to notify the Project Manager of the schedule changes associated with a Notice of Proposed Change Order by submitting a revised schedule document, it will be deemed to be an acknowledgment by Contractor that the proposed Extra Work will not have any scheduling consequences. The Contractor agrees the Change Order Proposal will in no event include a combined profit and home office overhead rate in excess of fifteen (15%) percent of the direct labor and material costs, unless the Project Manager determines that the complexity and risk of the Extra Work is such that an additional factor is appropriate. The Change Order Proposal may be accepted or modified by negotiations between the Contractor and the County. If an agreement on the Extra Work is reached, both parties shall execute the Extra Work order in writing. The execution by the Contractor of the Extra Work order shall serve as a release of the County from all claims and liability to the Contractor relating to, or in connection with, the Extra Work, including any impact, and any prior acts, neglect or default of the County relating to the Extra Work.

1.19 MIAMI-DADE COUNTY'S USER ACCESS PROGRAM (UAP).

- A. This project is federally funded, therefore UAP does not apply for this project.

1.20 PUBLIC RECORDS AND CONTRACTS FOR SERVICES PERFORMED ON BEHALF OF MIAMI-DADE COUNTY.

- A. The Contractor shall comply with the Public Records Laws of the State of Florida, including but not limited to,:
  - 1. Keeping and maintaining all public records that ordinarily and necessarily would be required by Miami-Dade County (County) in order to perform the service
  - 2. Providing the public with access to public records on the same terms and conditions that the County would provide the records and at a cost that does not exceed the cost provided in Chapter 119, F.S., or as otherwise provided by law
  - 3. Ensuring that public records that are exempt or confidential and exempt from public records disclosure requirements are not disclosed except as authorized by law; and

4. Meeting all requirements for retaining public records and transferring, at no cost, to the County all public records in possession of the Contractor upon termination of the contract and destroying any duplicate public records that are exempt or confidential and exempt from public records disclosure requirements upon such transfer.
- B. In addition, all records stored electronically must be provided to the County in a format that is compatible with the information technology systems of the County. Failure to meet any of these provisions or to comply with Florida's Public Records Laws as applicable shall be a material breach of the agreement and shall be enforced in accordance with the terms of the agreement.
- C. For questions regarding the application of chapter 119, Florida Statutes, to The Contractor's Duty to Provide Public Records relating to this contract, contact the Custodian of Public Records at (305) 375-4735; [isd-vss@miamidade.gov](mailto:isd-vss@miamidade.gov); 111 NW 1 Street, suite 1300, Miami, Florida 33128.

#### 1.21 NONDISCRIMINATION

- A. During the performance of this Contract, Contractor agrees to not discriminate against any employee or applicant for employment because of race, color, religion, ancestry, national origin, sex, pregnancy, age, disability, marital status, familial status, sexual orientation, gender identity or gender expression, status as victim of domestic violence, dating violence or stalking, or veteran status, and on housing related contracts the source of income, and will take affirmative action to ensure that employees and applicants are afforded equal employment opportunities without discrimination. Such action shall be taken with reference to, but not limited to: recruitment, employment, termination, rates of pay or other forms of compensation, and selection for training or retraining, including apprenticeship and on the job training.
- B. By entering into this Contract, the Contractor attests that it is not in violation of the Americans with Disabilities Act of 1990 (and related Acts) or Miami-Dade County Resolution No. R-385-95. If the Contractor or any owner, subsidiary or other firm affiliated with or related to the Contractor is found by the responsible enforcement agency or the County to be in violation of the Act or the Resolution, such violation shall render this Contract void. This Contract shall be void if the Contractor submits a false affidavit pursuant to this Resolution or the Contractor violates the Act or the Resolution during the term of this Contract, even if the Contractor was not in violation at the time it submitted its affidavit.

#### 1.22 CONTRACTOR DUE DILIGENCE AFFIDAVIT

- A. In accordance with Board of County Commissioners Resolution 63-14, Contractor, as a condition of award, must submit Contractor Due Diligence Affidavit Form on any contract that exceeds \$1 million, or that is otherwise subject to Board approval.
  1. Affidavit is attached in Section 2 of these Solicitation Documents and must be included in the solicitation package. Form requires that Contractors attest to the following under oath:
    - a. All of the lawsuits that have been filed against that entity, its directors, partners, principals, and/or board members, based on breach of contract by that entity in the five years prior to bid or proposal submittal, including the case name and number and the disposition of the case;
    - b. Any instances in the five years prior to bid or proposal submittal where that entity has been defaulted and a brief description of the circumstances; and

- c. All of the instances in the five years prior to bid or proposal submission where that entity has been debarred or received a formal notice of non-compliance or non-performance, such as a notice to cure or a suspension from participating or bidding for contracts, whether related to Miami-Dade County or not.
- B. It is the responsibility of the Contractor to return the fully executed Affidavit at the time of bid or proposal submittal. This affidavit will be used as an additional measure of due diligence prior to award of a contract.
- C. In accord with Resolution No. R-828-19, the County reserves the right to request from any bidder the disclosure of any lawsuits which include allegations of discrimination in the last ten years prior to date of solicitation, the disposition of such lawsuits, or statement that there are no such lawsuits.
- D. As per Miami-Dade County Resolution R-1181-18, Submit OSHA form 300 containing a list of the company's work-related injury and illness data; and OSHA inspection data, for the previous three years, for the contractor and first tier subcontractors. The Department of Labor Occupational and safety Health Administration (OSHA) Form 300, 300A and 301 can be found under Appendix <<E>> of these Supplementary Conditions.

### 1.23 CLAIMS

- A. Amend Paragraph 2.78 of the CICC 7360-0/08 Miscellaneous Construction Contract by adding the following:
  - B. Notice of Claims
    - 1. The Contractor will not be entitled to additional time or compensation otherwise payable for any act or failure to act by the Department, the happening of any event or occurrence, or any other cause, unless he shall have given the Project manager a written notice of claim therefore as specified in this article.
    - 2. The Contractor shall provide immediate verbal notification with written confirmation within forty-eight (48) hours of any potential claims and of the anticipated time and/or cost impacts resulting thereof. The written notice of claim shall set forth the reasons for which the Contractor believes additional compensation and/or time will or may be due, the nature of the costs involved and the approximate amount of the potential claim.
    - 3. It is the intention of this article, that differences between the parties arising under and by virtue of the Contract shall be brought to the attention of the Project Manager at the earliest possible time in order that such matters may be settled, if possible, or other appropriate action promptly taken.
    - 4. The notice requirements of this article are in addition to those required in other articles of these Contract Documents, inclusive of the conditions listed under the MCC Plan.
    - 5. The Contractor shall segregate all costs associated with each individual claim including but not limited to labor, equipment, material, subcontractor and supplier costs, and all other costs related to the claim. In the event that the Contractor has multiple claims, the Contractor will segregate each claim individually including the respective costs associated with each claim. Failure to segregate claims and their respective costs will be grounds for the Department's rejection of the claim. No "total cost claims" shall be allowed under this Contract.



6. The Contractor must maintain a cost accounting system as a condition for making a claim against the Department. The cost accounting system must segregate the costs of the work under the Contract (non-claims-related) from claims-related and other Contractor costs through the use of a job cost ledger and be otherwise in compliance with general accounting principles.
7. If the Department decides to pay all or part of a claim for which notice was not timely made, the Department does not waive the right to enforce the notice requirements in connection with any other claim.
8. Inasmuch as the notice of claim requirements of this article are intended to enable the Project Manager to investigate while facts are fresh and to take action to minimize or avoid a claim which might be filed thereafter, the Contractor's failure to make the required notice on time is likely to disadvantage the Department. Therefore, a claim that does not comply with the notice requirements above shall not be considered unless the Contractor submits with his claim proof showing that the Department has not been prejudiced by the Contractor's failure to so comply and, in the event the Department has been prejudiced by the Contractor's failure to submit a timely notice of claim, the Department will reduce any equitable adjustment claimed by the Contractor to reflect the damage.

#### C. Claim Submittals

1. Claims or requests for equitable adjustments filed by the Contractor shall be filed in full accordance with this article no later than 30 calendar days after the act giving rise to the claim and in sufficient detail to enable the Department to ascertain the basis and amount of said claims. In the case of continuing or on-going claim events, the Contractor shall be allowed to periodically amend his claim to more accurately reflect the impact of said claim, until the end of the claim event. No claims for additional compensation, time extension or for any other relief under the Contract shall be recognized, processed, or treated in any manner unless the same is presented in accordance with this Article. Failure to present and process any claim in accordance with this Article shall be conclusively deemed a waiver, abandonment or relinquishment of any such claim, it being expressly understood and agreed that the timely presentation of claims, in sufficient detail to allow proper investigation and prompt resolution thereof, is essential to the administration of this Contract.
2. The Department will review and evaluate the Contractor's claims. It will be the responsibility of the Contractor to furnish, when requested by the Project manager, such further information and details as may be required to determine the facts or contentions involved in his claims. The cost of claims preparation or Change Order negotiations shall not be reimbursable under this Contract.
3. Any work performed by the Contractor prior to Notice-to-Proceed (NTP) shall not be the basis for a claim from the Contractor of any kind.
4. Each claim must be certified by the Contractor as required by the Miami-Dade Code, False Claims Act (see Code Section 21-255, et seq.), and accompanied by all materials required by Miami-Dade County Code Section 21-257. A "certified claim" shall be made under oath by a person duly authorized by the claimant, and shall contain a statement that:
  - a. The claim is made in good faith;
  - b. The claim's supporting data is accurate and complete to the best of the person's knowledge and belief;
  - c. The amount of the claim accurately reflects the amount that the claimant believes is due from the Department; and

- d. The certifying person is duly authorized by the claimant to certify the claim.
5. In order to substantiate time-related claims (delays, disruptions, impacts, etc.), the Contractor shall, if applicable and as determined by the Department, submit, in triplicate, the following information:
- a. Copy of Contractor's notice of claim in accordance with this article. Failure to submit the notice is sufficient grounds to deny the claim.
  - b. The approved, as-planned Schedule in accordance with the applicable section of the Contract Documents and computer storage media, if applicable.
  - c. The as-built Schedule reflecting changes to the approved schedule up to the time of the impact in question and computer storage media if applicable.
  - d. The basis for the duration of the start and finish dates of each impact activity and the reason for choosing the successor and predecessor events affected in the schedule shall be explained. Also, the basis for the duration of any lead/lags inserted into the schedule and the duration in related activity duration shall be explained.
  - e. A marked-up as-built Schedule indicating the causes responsible for changes between the as-planned and as-built schedule and establishing the required cause and effect relationships.
  - f. After indicating specific time related changes on the as-built schedule, the documentation must be segregated into separate packages with each package documenting a specific duration change identified previously. This documentation package shall include Change Orders, Change Notices, Work Orders, written directions, meeting minutes, etc., related to the change in duration.
  - g. Any loss of efficiency, acceleration, disruption and loss of productivity claims shall be compensated as part of the Liquidated Indirect Costs paid for compensable, excusable delays and mark-up on Direct Cost of changes as allowed by the Contract. Total cost and modified total cost claims will not be accepted and the Contractor agrees to waive the right to seek recovery by these methods. The claimed delay shall not result from a cause specified in the Contract Documents as a non-excusable delay.
  - h. The Contractor assumes all risk for the following items, none of which shall be the subject of any claim and none of which shall be compensated for except as they may have been included in the compensation described under Liquidated Indirect Costs:
    - 1) Home office expenses or any Direct Costs incurred allocated from the headquarters of the Contractor;
    - 2) Loss of anticipated profits on this or any other project;
    - 3) Loss of bonding capacity or capability;
    - 4) Losses due to other projects not bid upon;
    - 5) Loss of business opportunities;
    - 6) Loss of productivity on this or any other project;
    - 7) Loss of interest income on funds not paid;
    - 8) Costs to prepare, negotiate or prosecute claims and
    - 9) Costs spent to achieve compliance with applicable laws and ordinances (excepting only sales taxes paid shall be reimbursable expense subject to the provisions of the Contract Documents).

- i. All non-time-related claim items for additional compensation for Direct Costs shall be properly documented and supported with copies of invoices, time sheets, rental agreements, crew sheets and the like.
  - j. Cost information shall be submitted in sufficient detail to allow for review. The basis for the budgeted or actual costs shall include man-hours by trade, labor rates, material and equipment costs etc. These costs shall be broken down by pay.
  - k. The documentation for budgeted cost shall, as a minimum, include:
    - 1) Copies of all the Contractor's bid documents, bid quotes, faxed quotes, etc.
    - 2) Copies of all executed subcontracts.
    - 3) Other related budget documents as requested by the Project Manager.
  - l. The documentation for actual cost shall, as a minimum, include:
    - 1) Time Sheets.
    - 2) Materials invoices
    - 3) Equipment invoices
    - 4) Subcontractors' payments
    - 5) Other related documents as required by the Project Manager.
  - m. The Contractor shall make all his books, employees, work sites and records available to the Department or its representatives for inspection and audit.
6. No payment shall be made to the Contractor by the Department for loss of anticipated profit(s) from any deleted work.
7. As indicated above, the Project Manager and the Field Representative shall be allowed full and complete access to all personnel, documents, work sites or other information reasonably necessary to investigate any claim. Within sixty (60) days after a claim has been received, the claim shall either be rejected with an explanation as to why it was rejected or acknowledged. Once the claim is acknowledged, the parties shall attempt to negotiate a satisfactory settlement of the claim, which settlement shall be included in a subsequent Work Order or Change Order. If the parties fail to reach an agreement on a recognized claim, the Department shall pay to the Contractor the amount of money it deems reasonable, less any appropriate retention, to compensate the Contractor for the recognized claim.
8. Failure of the Contractor to make a specific reservation of rights regarding any such disputed amounts in the body of the Change Order which contains the payment shall be construed as a waiver, abandonment, or relinquishment of all claims for additional monies resulting from the claims embodied in said Change Order. However, once the Contractor has properly reserved rights to any claim, no further reservations of rights shall be required and the Contractor shall not be required to repeat the reservation in any subsequent change order. Prior reservation of rights may however be modified, by express reference, in subsequent change orders. Notwithstanding the aforementioned, at the time of final payment under the Contract, the Contractor shall specify all claims which have been denied and all claims for which rights have been reserved in accordance with this section. Failure to so specify any particular claim shall be constructed as a waiver, abandonment, or relinquishment of such claim.

## 1.24 DISPUTES

A. Amend Paragraph 2.81 of the CICC 7360-0/08 Miscellaneous Construction Contract by adding the following:

B. Disputes

1. The following provisions shall govern disputes under this Contract unless the Special Provisions to this Contract contain the requirement for the use of an alternate dispute resolution method. For example, for large projects of great complexity, a Dispute Review Board (DRB) may be employed by the Department to settle disputes in lieu of the Department Director or Office of the Mayor (OOM) designee as specified below. In this case, the DRB alternative shall be specified by the Department in the Special Provisions and, if utilized, shall supersede this dispute provision.
  - a. In the event the Contractor and the Department are unable to resolve their differences concerning any determination made by the Project Manager or Department on any dispute or claim arising under or relating to the Contract (referred to in this Section as a "Dispute"), either the Contractor or the Department may initiate a dispute in accordance with the procedure set forth in this article. Exhaustion of these procedures shall be a precondition to any lawsuit permitted hereunder.
  - b. For contracts with a value of \$5 million or less, all Disputes under this Contract shall be decided by the Department Director or his designee. For contracts valued at more than \$5 million, Disputes shall be decided by a designee appointed by the OOM
  - c. As soon as practicable, the Department Director or OOM designee shall adopt a schedule for the Contractor and the Department to file written submissions stating their respective positions and the bases therefore. The written submissions shall include copies of all documents and sworn statements in affidavit form from all witnesses relied on by each party in support of its position. Within 20 working days of the date on which such written submissions are filed, the Department Director or OOM designee shall afford each party an opportunity to present a maximum of one hour of argument. The Department Director or OOM designee may decide the Dispute on the basis of the affidavits and other written submissions if, in his opinion, there is no issue of material fact and the party is entitled to a favorable resolution pursuant to the terms of this Contract. As part of such decision, the Department Director or OOM designee shall determine the timeliness and sufficiency of each notice of claim and claim at issue as provided in this article. The Department Director or OOM designee shall have the authority to rule on questions of law, including disputes over contract interpretation, and to resolve claims, or portions of claims, via summary judgment where there are no disputed issues of material fact. Furthermore, the Department Director or OOM designee is authorized by both parties to strike elements of claims seeking relief or damages not available under the contract (such as, but not limited to, claims for lost profits, off-site overhead, loss of efficiency or productivity claims or claim's preparation costs) by summary disposition.
  - d. In the event that the Department Director or OOM designee determines that the affidavits or other written submissions present issues of material fact, he shall allow the presentation of evidence in the form of lay or expert testimony directed solely to the issues which he may specifically identify to require factual resolution. The testimonial portion of the process shall not exceed one day in duration per side, including opening statements and closing arguments, if allowed by the Department Director or OOM designee at his reasonable discretion.
  - e. No formal discovery shall be allowed in connection with any proceeding under this article. Notwithstanding the foregoing, both parties agree that all of the audit, document inspection, information and documentation requirements set forth elsewhere in this contract shall remain in force and effect throughout the proceeding. The Department Director or OOM designee shall not schedule the hearing until both parties have made all their respective

records available for inspection and reproduction and the parties have been afforded reasonable time to analyze the records. The continued failure of a party to comply with the document inspection, examination, or submission requirements set forth in this contract shall constitute a waiver of that party's claims and/or defenses, as applicable. Hearsay evidence shall be admissible but shall not form the sole basis for any finding of fact. Failure of any party to participate on a timely basis, to cooperate in the proceedings, or to furnish evidence in support or defense of a claim shall be a criteria in determining the sufficiency and validity of a claim.

- f. The Department Director or OOM designee shall issue a written decision within 15 working days after conclusion of any testimonial proceeding and, if no testimonial proceeding is conducted, within 45 days of the filing of the last written submission. This written decision shall set forth the reasons for the disposition of the claim and a breakdown of any specific issues or subcontractor claims.
- g. If either party wishes to protest the decision of the Department Director or OOM designee, such party may commence an action in a court of competent jurisdiction, within the periods prescribed by law, it being understood that the review of the court shall be limited to the question of whether or not the Department Director or OOM designee's determination was arbitrary and capricious, unsupported by any competent evidence, or so grossly erroneous to evidence bad faith.
- h. Pending final decision of a dispute hereunder, the Contractor shall proceed diligently with the performance of the Contract and in accordance with the Department's interpretation. Any presentation or request by the Contractor under this article will be subject to the same requirements for Submittal of Claims in this article.

#### 1.25 EXTRA WORK

- A. The following Subarticle replaces the following items: Article 2.83, Extra Work and Payment Therefore, of the Special Conditions of the MCC 7360 Plan,:
  1. Contractor may be asked to perform extra work, for which there is no price included in the Proposal, wherever it is deemed necessary or desirable by the Engineer to satisfactorily complete the Project as contemplated, and such extra work must be performed promptly in accordance with the Specifications and as directed by the Engineer, provided, however, that before any extra work is begun, a written order from the Engineer to do the work shall be given to the Contractor. No extra work will be paid for unless ordered in writing.
  2. All changed or added work so authorized shall be performed by the Contractor at the time and in the manner specified.
  3. The Change Order shall include, as a minimum:
    - a. Scope of work to be added, deleted or modified;
    - b. Cost of work to be added, deleted or modified;
    - c. The Contract time extension or reduction in contract time in the case of deleted work required to perform the work to be added, deleted or modified;
    - d. Full release of claims associated with the Contract through the date of the change order, or a reservation of claims identified as to each claim reserved, the scope of the work, the maximum cost of the work, and the maximum number of days of Contract time requested, shall be specified.

4. The Work Order shall include, at a minimum:
  - a. Scope of work to be added, deleted or modified;
  - b. Cost of work to be added, deleted or modified;
  - c. The Contract time extension required to perform the work to be added, deleted or modified;
  - d. Full release of claims associated with the work order work, or a reservation of claims identified as to each claim reserved, the scope of the work, the maximum cost of the work, and the maximum number of days of Contract time requested, shall be specified.

B. Allowable Costs for Extra Work

1. The following Subarticle replaces the following items: Article 2.83, Extra Work and Payment Therefore, of the Special Conditions of the MCC 7360 Plan:
2. The Engineer may direct in writing that extra work be done and, at the Engineer's sole discretion, the Contractor will be paid pursuant to an agreed Supplemental Agreement or in the following manner:
  - a. Labor and Burden: The Contractor will receive payment for actual costs of direct labor and burden for the additional or unforeseen work. Labor includes foremen actually engaged in the work; and will not include project supervisory personnel nor necessary on-site clerical staff, except when the additional or unforeseen work is a controlling work item and the performance of such controlling work item actually extends completion of the project due to no fault of the Contractor. Compensation for project supervisory personnel, but in no case higher than a Project Manager's position, shall only be for the pro-rata time such supervisory personnel spent on the contract. In no case shall an officer or director of the Company, nor those persons who own more than 1% of the Company, be considered as project supervisory personnel, direct labor or foremen hereunder.

Payment for burden shall be limited solely to the following:

Table 1.25 B	
Item	Rate
FICA	Rate established by Law
FUTA/SUTA	Rate established by Law
Medical Insurance	Actual
Holidays, Sick & Vacation benefits	Actual
Retirement benefits	Actual
Workers Compensation	Rates based on the National Council on Compensation Insurance basic rate tables adjusted by Contractor's actual experience modification factor in effect at the time of the additional work or unforeseen work.
Per Diem	Actual but not to exceed State of Florida's rate

Insurance*	Actual
*Compensation for Insurance is limited solely to General Liability Coverage and does not include any other insurance coverage (such as, but not limited to, Umbrella Coverage, Automobile Insurance, etc.).	

At the Pre-construction conference, certify to the Engineer the following:

- 1) A listing of on-site clerical staff, supervisory personnel and their pro-rated time assigned to the contract,
  - 2) Actual Rate for items listed in Table 4-3.2.1,
  - 3) Existence of employee benefit plan for Holiday, Sick and Vacation benefits and a Retirement Plan, and,
  - 4) Payment of Per Diem is a company practice for instances when compensation for Per Diem is requested. Such certification must be made by an officer or director of the Contractor with authority to bind the Contractor. Timely certification is a condition precedent to any right of the Contractor to recover compensations for such costs, and failure to timely submit the certification will constitute a full, complete, absolute and irrevocable waiver by the Contractor of any right to recover such costs. Any subsequent changes shall be certified to the Engineer as part of the cost proposal or seven calendar days in advance of performing such extra work.
- b. Materials and Supplies: For materials accepted by the Engineer and used on the project, the Contractor will receive the actual cost of such materials incorporated into the work, including Contractor paid transportation charges (exclusive of equipment as hereinafter set forth). For supplies reasonably needed for performing the work, the Contractor will receive the actual cost of such supplies.
- c. Equipment: For any machinery or special equipment (other than small tools), including fuel and lubricant, the Contractor will receive 100% of the "Rental Rate Blue Book" for the actual time that such equipment is in operation on the work, and 50% of the "Rental Rate Blue Book" for the time the equipment is directed to standby and remain on the project site, to be calculated as indicated below. The equipment rates will be based on the latest edition (as of the date the work to be performed begins) of the "Rental Rate Blue Book for Construction Equipment" or the "Rental Rate Blue Book for Older Construction Equipment," whichever is applicable, as published by Machinery Information Division of PRIMEDIA Information, Inc. (version current at the time of bid), using all instructions and adjustments contained therein and as modified below. On all projects, the Engineer will adjust the rates using regional adjustments and Rate Adjustment Tables according to the instructions in the Blue Book.

Allowable Equipment Rates will be established as set out below:

- 1) Allowable Hourly Equipment Rate =  $\text{Monthly Rate} / 176 \times \text{Adjustment Factors} \times 100\%$ .
- 2) Allowable Hourly Operating Cost =  $\text{Hourly Operating Cost} \times 100\%$ .
- 3) Allowable Rate Per Hour =  $\text{Allowable Hourly Equipment Rate} + \text{Allowable Hourly Operating Cost}$ .
- 4) Standby Rate =  $\text{Allowable Hourly Equipment Rate} \times 50\%$ .
- 5) The Monthly Rate is The Basic Machine Rate Plus Any Attachments. Standby rates will apply when equipment is not in operation and is directed by the Engineer to standby at the project site when needed again to complete work and the cost of moving the equipment will exceed the accumulated standby cost. Standby rates will not apply on any day the equipment operates for eight or more hours. Standby payment will be

limited to only that number of hours which, when added to the operating time for that day equals eight hours. Standby payment will not be made on days that are not normally considered work days on the project.

- 6) The County will allow for the cost of transporting the equipment to and from the location at which it will be used. If the equipment requires assembly or disassembly for transport, the County will pay for the time to perform this work at the rate for standby equipment.
  - 7) Equipment may include vehicles utilized only by Labor, as defined above.
- d. Indirect Costs, Expenses, and Profit: Compensation for all indirect costs, expenses, and profit of the Contractor, including but not limited to overhead of any kind, whether jobsite, field office, division office, regional office, home office, or otherwise, is expressly limited to the greater of either (1) or (2) below:
- 1) Solely a mark-up of 17.5% on the payments in (a) through (c), above.
    - a) Bond: The Contractor will receive compensation for any premium for acquiring a bond for such additional or unforeseen work at the original Contract bond rate paid by the Contractor. No compensation for bond premium will be allowed for additional or unforeseen work paid by the Department via initial contingency pay item.
    - b) The Contractor will be allowed a markup of 10% on the first \$50,000 and a markup of 5% on any amount over \$50,000 on any subcontract directly related to the additional or unforeseen work. Any such subcontractor mark-up will be allowed only by the prime Contractor and a first tier subcontractor, and the Contractor must elect the markup for any eligible first tier subcontractor to do so.
  - 2) Solely the formula set forth below and only as applied solely as to such number of calendar days of entitlement that are in excess of ten cumulative calendar days as defined below.

$$D = \frac{A \times C}{B}$$

Where A= Original Contract Amount

B= Original Contract Time

C= 8%

D= Average Overhead Per Day

- 3) Cumulative Calendar Days is defined as the combined total number of calendar days granted as time extensions due to either extra work, excluding overruns to existing contract items, that extend the duration of the project or delay of a controlling work item caused solely by the Department, or the combined total number of calendar days for which a claim of entitlement to a time extension due to delay of a controlling work item caused solely by the Department is otherwise ultimately determined to be in favor of the Contractor.
- 4) No compensation, whatsoever, will be paid to the Contractor for any jobsite overhead and other indirect impacts when the total number of calendar days granted for time extension due to delay of a controlling work item caused solely by the Department is, or the total number of calendar days for which entitlement to a time extension due to delay of a controlling work item caused solely by the Department is otherwise ultimately determined in favor of the Contractor to be, equal to or less than ten calendar days and the Contractor also fully assumes all monetary risk of any and all partial or single calendar day delay periods, due to delay of a controlling work item caused solely by the Department, that when combined together are equal to or less than ten calendar



days and regardless of whether monetary compensation is otherwise provided for hereunder for one or more calendar days of time extension entitlement for each calendar day exceeding ten calendar days. All calculations under this provision shall exclude weather days, Holidays, and Special Events.

- 5) Further, for (1) or (2) above, in the event there are concurrent delays to one or more controlling work items, one or more being caused by the Department and one or more being caused by the Contractor, the Contractor shall be entitled to a time extension for each day that a controlling work item is delayed by the Department but shall have no right to nor receive any monetary compensation for any indirect costs for any days of concurrent delay.

## 1.26 WARRANTY OF CONSTRUCTION

- A. For a period of one year, except as provided below, from the date of Final Acceptance, the Contractor warrants that the Work conforms to the Contract requirements and the RPQ requirements and is free of any patent and/or latent defect of the material or workmanship.

1. Exception to the above year warranty:

- a. Where the manufacturer of material provides a warranty in excess of one (1) year, the Contractor shall provide an assignment of warranty to the County with the manufacturer's written authorization. Contractors shall be obligated to provide to the County copies of all manufacturer's warranties and guarantees. Where the County specifies in an RPQ a warranty greater than one (1) year, such warranty will only be for the specified RPQ.
- b. The warranty hereunder shall be in addition to whatever rights the County may have under law. The Contractor's obligation under this warranty shall be at its own cost and expense, to promptly repair or replace (including cost of removal and installation), that item (or part of component thereof) which proves defective or fails to comply with the Contract within the warranty period such that it complies with the Contract.
- c. In the event the Contractor fails to repair or replace defective Work in accordance with the terms of the Contract, the RPQ, and this warranty, the County shall have the right to collect such costs incurred or withhold the cost of the anticipated repairs by offsetting the amount against any payment due the Contractor under any contract between the County and the Contractor.
- d. As specified in the construction documents. All guarantees and warranties under the Contract are fully enforceable by the County acting in its own name.

## 1.27 CONFLICT OF INTEREST

- A. In addition to the requirements of Sec. 2-11.1. – Miami-Dade County Conflict of Interest and Code of Ethics Ordinance. (January 2016). The contractor must comply with the following requirement:

1. f.) Neither the Recipient nor any of its contractors or their subcontractors shall enter into any contract, subcontract or arrangement in connection with the Project or any property included or planned to be included in the Project in which any member, officer or employee of Miami-Dade County (the County) during tenure or for 2 years thereafter has any interest, direct or indirect. If any such present or former member, officer or employee involuntarily acquires or had acquired prior to the beginning of tenure any such interest, and if such interest is immediately disclosed to the County, the County, with prior approval of the FDOT, may waive the prohibition contained in this paragraph provided that any such present member, officer or

employee shall not participate in any action by the County relating to such contract, subcontract or arrangement.

2. Contractor is required to insert the language below in all contracts entered into in connection with the Project and its subcontracts:
  - a. "No member, officer or employee of Miami Dade County during his tenure or for 2 years thereafter shall have any interest, direct or indirect, in this contract or the proceeds thereof."
  - b. The provisions of this paragraph shall not be applicable to any agreement between the County and its fiscal depositories or to any agreement for utility services the rates for which are fixed or controlled by a governmental agency.

APPENDIX A OF THE SUPPLEMENTARY CONDITIONS  
DAVIS BACON WAGES

"General Decision Number: FL20220178 02/25/2022

Superseded General Decision Number: FL20210178

State: Florida

Construction Type: Highway

County: Miami-Dade County in Florida.

HIGHWAY CONSTRUCTION PROJECTS

Note: Contracts subject to the Davis-Bacon Act are generally required to pay at least the applicable minimum wage rate required under Executive Order 14026 or Executive Order 13658. Please note that these Executive Orders apply to covered contracts entered into by the federal government that are subject to the Davis-Bacon Act itself, but do not apply to contracts subject only to the Davis-Bacon Related Acts, including those set forth at 29 CFR 5.1(a)(2)-(60).

If the contract is entered into on or after January 30, 2022, or the contract is renewed or extended (e.g., an option is exercised) on or after January 30, 2022:	. Executive Order 14026 generally applies to the contract. . The contractor must pay all covered workers at least \$15.00 per hour (or the applicable wage rate listed on this wage determination, if it is higher) for all hours spent performing on the contract in 2022.
If the contract was awarded on or between January 1, 2015 and January 29, 2022, and the contract is not renewed or extended on or after January 30, 2022:	. Executive Order 13658 generally applies to the contract. . The contractor must pay all covered workers at least \$11.25 per hour (or the applicable wage rate listed on this wage determination, if it is higher) for all hours spent performing on that contract in 2022.

The applicable Executive Order minimum wage rate will be adjusted annually. If this contract is covered by one of the

Executive Orders and a classification considered necessary for performance of work on the contract does not appear on this wage determination, the contractor must still submit a conformance request.

Additional information on contractor requirements and worker protections under the Executive Orders is available at <https://www.dol.gov/agencies/whd/government-contracts>.

Modification Number	Publication Date
0	01/07/2022
1	02/25/2022

ELEC0349-002 09/01/2021

	Rates	Fringes
ELECTRICIAN.....	\$ 37.61	11.72

\* SUFL2013-039 08/19/2013

	Rates	Fringes
CARPENTER.....	\$ 17.84	0.00
CEMENT MASON/CONCRETE FINISHER, Includes Form Work.....	\$ 15.49	0.00
FENCE ERECTOR.....	\$ 12.82 **	0.00
HIGHWAY/PARKING LOT STRIPING: Operator (Striping Machine).....	\$ 15.07	0.00
HIGHWAY/PARKING LOT STRIPING: Painter.....	\$ 12.13 **	0.00
HIGHWAY/PARKING LOT STRIPING: Operator (Spray Nozzleman).....	\$ 11.16 **	0.00
INSTALLER - GUARDRAIL.....	\$ 13.43 **	0.00
IRONWORKER, ORNAMENTAL.....	\$ 13.48 **	0.00
IRONWORKER, REINFORCING.....	\$ 18.43	0.00
IRONWORKER, STRUCTURAL.....	\$ 16.42	0.00

LABORER (Traffic Control  
Specialist incl. placing of

cones/barricades/barrels - Setter, Mover, Sweeper).....	\$ 11.59 **	0.00
LABORER: Asphalt, Includes Raker, Shoveler, Spreader and Distributor.....	\$ 12.31 **	0.00
LABORER: Common or General.....	\$ 10.69 **	0.00
LABORER: Flagger.....	\$ 12.53 **	0.00
LABORER: Grade Checker.....	\$ 12.41 **	0.00
LABORER: Landscape & Irrigation.....	\$ 9.02 **	0.00
LABORER: Mason Tender - Cement/Concrete.....	\$ 13.91 **	3.50
LABORER: Pipelayer.....	\$ 15.02	0.00
OPERATOR: Backhoe/Excavator/Trackhoe.....	\$ 16.24	0.00
OPERATOR: Bobcat/Skid Steer/Skid Loader.....	\$ 12.88 **	0.00
OPERATOR: Boom.....	\$ 18.95	0.00
OPERATOR: Boring Machine.....	\$ 15.29	0.00
OPERATOR: Broom/Sweeper.....	\$ 13.01 **	0.00
OPERATOR: Bulldozer.....	\$ 16.77	0.00
OPERATOR: Concrete Finishing Machine.....	\$ 15.44	0.00
OPERATOR: Concrete Saw.....	\$ 14.43 **	0.00
OPERATOR: Crane.....	\$ 22.46	0.00
OPERATOR: Curb Machine.....	\$ 20.74	0.00
OPERATOR: Distributor.....	\$ 13.29 **	0.00
OPERATOR: Drill.....	\$ 14.78 **	0.00
OPERATOR: Forklift.....	\$ 16.32	0.00

OPERATOR: Gradall.....	\$ 14.71 **	0.00
OPERATOR: Grader/Blade.....	\$ 20.22	3.85
OPERATOR: Loader.....	\$ 15.53	0.00
OPERATOR: Mechanic.....	\$ 18.03	0.00
OPERATOR: Milling Machine.....	\$ 14.67 **	0.00
OPERATOR: Oiler.....	\$ 16.32	0.00
OPERATOR: Paver (Asphalt, Aggregate, and Concrete).....	\$ 13.61 **	0.00
OPERATOR: Piledriver.....	\$ 17.23	0.00
OPERATOR: Post Driver (Guardrail/Fences).....	\$ 14.45 **	0.00
OPERATOR: Roller.....	\$ 13.67 **	0.00
OPERATOR: Scraper.....	\$ 12.01 **	0.00
OPERATOR: Screed.....	\$ 14.15 **	0.00
OPERATOR: Tractor.....	\$ 12.19 **	0.00
OPERATOR: Trencher.....	\$ 14.74 **	0.00
PAINTER: Spray.....	\$ 16.52	0.00
SIGN ERECTOR.....	\$ 12.96 **	0.00
TRAFFIC SIGNALIZATION: Traffic Signal Installation.....	\$ 19.07	0.00
TRUCK DRIVER: Distributor Truck.....	\$ 14.96 **	2.17
TRUCK DRIVER: Dump Truck.....	\$ 12.19 **	0.00
TRUCK DRIVER: Flatbed Truck.....	\$ 14.28 **	0.00
TRUCK DRIVER: Lowboy Truck.....	\$ 15.07	0.00
TRUCK DRIVER: Slurry Truck.....	\$ 11.96 **	0.00
TRUCK DRIVER: Vector Truck.....	\$ 14.21 **	0.00

TRUCK DRIVER: Water Truck.....\$ 13.17 \*\* 1.60

-----  
WELDERS - Receive rate prescribed for craft performing operation to which welding is incidental.

=====

\*\* Workers in this classification may be entitled to a higher minimum wage under Executive Order 14026 (\$15.00) or 13658 (\$11.25). Please see the Note at the top of the wage determination for more information.

Note: Executive Order (EO) 13706, Establishing Paid Sick Leave for Federal Contractors applies to all contracts subject to the Davis-Bacon Act for which the contract is awarded (and any solicitation was issued) on or after January 1, 2017. If this contract is covered by the EO, the contractor must provide employees with 1 hour of paid sick leave for every 30 hours they work, up to 56 hours of paid sick leave each year. Employees must be permitted to use paid sick leave for their own illness, injury or other health-related needs, including preventive care; to assist a family member (or person who is like family to the employee) who is ill, injured, or has other health-related needs, including preventive care; or for reasons resulting from, or to assist a family member (or person who is like family to the employee) who is a victim of, domestic violence, sexual assault, or stalking. Additional information on contractor requirements and worker protections under the EO is available at <https://www.dol.gov/agencies/whd/government-contracts>.

Unlisted classifications needed for work not included within the scope of the classifications listed may be added after award only as provided in the labor standards contract clauses (29CFR 5.5 (a) (1) (ii)).

-----

The body of each wage determination lists the classification and wage rates that have been found to be prevailing for the cited type(s) of construction in the area covered by the wage determination. The classifications are listed in alphabetical order of ""identifiers"" that indicate whether the particular rate is a union rate (current union negotiated rate for local), a survey rate (weighted average rate) or a union average rate (weighted union average rate).



## Union Rate Identifiers

A four letter classification abbreviation identifier enclosed in dotted lines beginning with characters other than ""SU"" or ""UAVG"" denotes that the union classification and rate were prevailing for that classification in the survey. Example: PLUM0198-005 07/01/2014. PLUM is an abbreviation identifier of the union which prevailed in the survey for this classification, which in this example would be Plumbers. 0198 indicates the local union number or district council number where applicable, i.e., Plumbers Local 0198. The next number, 005 in the example, is an internal number used in processing the wage determination. 07/01/2014 is the effective date of the most current negotiated rate, which in this example is July 1, 2014.

Union prevailing wage rates are updated to reflect all rate changes in the collective bargaining agreement (CBA) governing this classification and rate.

## Survey Rate Identifiers

Classifications listed under the ""SU"" identifier indicate that no one rate prevailed for this classification in the survey and the published rate is derived by computing a weighted average rate based on all the rates reported in the survey for that classification. As this weighted average rate includes all rates reported in the survey, it may include both union and non-union rates. Example: SULA2012-007 5/13/2014. SU indicates the rates are survey rates based on a weighted average calculation of rates and are not majority rates. LA indicates the State of Louisiana. 2012 is the year of survey on which these classifications and rates are based. The next number, 007 in the example, is an internal number used in producing the wage determination. 5/13/2014 indicates the survey completion date for the classifications and rates under that identifier.

Survey wage rates are not updated and remain in effect until a new survey is conducted.

## Union Average Rate Identifiers

Classification(s) listed under the UAVG identifier indicate that no single majority rate prevailed for those classifications; however, 100% of the data reported for the classifications was union data. EXAMPLE: UAVG-OH-0010 08/29/2014. UAVG indicates that the rate is a weighted union average rate. OH indicates the state. The next number, 0010 in the example, is an internal number used in producing the wage determination. 08/29/2014 indicates the survey completion date

for the classifications and rates under that identifier.

A UAVG rate will be updated once a year, usually in January of each year, to reflect a weighted average of the current negotiated/CBA rate of the union locals from which the rate is based.

---

#### WAGE DETERMINATION APPEALS PROCESS

1.) Has there been an initial decision in the matter? This can be:

- \* an existing published wage determination
- \* a survey underlying a wage determination
- \* a Wage and Hour Division letter setting forth a position on a wage determination matter
- \* a conformance (additional classification and rate) ruling

On survey related matters, initial contact, including requests for summaries of surveys, should be with the Wage and Hour National Office because National Office has responsibility for the Davis-Bacon survey program. If the response from this initial contact is not satisfactory, then the process described in 2.) and 3.) should be followed.

With regard to any other matter not yet ripe for the formal process described here, initial contact should be with the Branch of Construction Wage Determinations. Write to:

Branch of Construction Wage Determinations  
Wage and Hour Division  
U.S. Department of Labor  
200 Constitution Avenue, N.W.  
Washington, DC 20210

2.) If the answer to the question in 1.) is yes, then an interested party (those affected by the action) can request review and reconsideration from the Wage and Hour Administrator (See 29 CFR Part 1.8 and 29 CFR Part 7). Write to:

Wage and Hour Administrator  
U.S. Department of Labor  
200 Constitution Avenue, N.W.  
Washington, DC 20210

The request should be accompanied by a full statement of the

interested party's position and by any information (wage payment data, project description, area practice material, etc.) that the requestor considers relevant to the issue.

3.) If the decision of the Administrator is not favorable, an interested party may appeal directly to the Administrative Review Board (formerly the Wage Appeals Board). Write to:

Administrative Review Board  
U.S. Department of Labor  
200 Constitution Avenue, N.W.  
Washington, DC 20210

4.) All decisions by the Administrative Review Board are final.

=====

END OF GENERAL DECISIO"

APPENDIX B OF THE SUPPLEMENTARY CONDITIONS  
FHWA-1273 REQUIRED CONTRACT PROVISIONS FOR FEDERAL AID  
CONSTRUCTION CONTRACTS

**REQUIRED CONTRACT PROVISIONS  
FEDERAL-AID CONSTRUCTION CONTRACTS**

- I. General
- II. Nondiscrimination
- III. Non-segregated Facilities
- IV. Davis-Bacon and Related Act Provisions
- V. Contract Work Hours and Safety Standards Act Provisions
- VI. Subletting or Assigning the Contract
- VII. Safety: Accident Prevention
- VIII. False Statements Concerning Highway Projects
- IX. Implementation of Clean Air Act and Federal Water Pollution Control Act
- X. Certification Regarding Debarment, Suspension, Ineligibility and Voluntary Exclusion
- XI. Certification Regarding Use of Contract Funds for Lobbying
- XII. Use of United States-Flag Vessels:

**ATTACHMENTS**

A. Employment and Materials Preference for Appalachian Development Highway System or Appalachian Local Access Road Contracts (included in Appalachian contracts only)

**I. GENERAL**

1. Form FHWA-1273 must be physically incorporated in each construction contract funded under title 23, United States Code, as required in 23 CFR 633.102(b) (excluding emergency contracts solely intended for debris removal). The contractor (or subcontractor) must insert this form in each subcontract and further require its inclusion in all lower tier subcontracts (excluding purchase orders, rental agreements and other agreements for supplies or services). 23 CFR 633.102(e).

The applicable requirements of Form FHWA-1273 are incorporated by reference for work done under any purchase order, rental agreement or agreement for other services. The prime contractor shall be responsible for compliance by any subcontractor, lower-tier subcontractor or service provider. 23 CFR 633.102(e).

Form FHWA-1273 must be included in all Federal-aid design-build contracts, in all subcontracts and in lower tier subcontracts (excluding subcontracts for design services, purchase orders, rental agreements and other agreements for supplies or services) in accordance with 23 CFR 633.102. The design-builder shall be responsible for compliance by any subcontractor, lower-tier subcontractor or service provider.

Contracting agencies may reference Form FHWA-1273 in solicitation-for-bids or request-for-proposals documents, however, the Form FHWA-1273 must be physically incorporated (not referenced) in all contracts, subcontracts and lower-tier subcontracts (excluding purchase orders, rental agreements and other agreements for supplies or services related to a construction contract). 23 CFR 633.102(b).

2. Subject to the applicability criteria noted in the following sections, these contract provisions shall apply to all work

performed on the contract by the contractor's own organization and with the assistance of workers under the contractor's immediate superintendence and to all work performed on the contract by piecework, station work, or by subcontract. 23 CFR 633.102(d).

3. A breach of any of the stipulations contained in these Required Contract Provisions may be sufficient grounds for withholding of progress payments, withholding of final payment, termination of the contract, suspension / debarment or any other action determined to be appropriate by the contracting agency and FHWA.

4. Selection of Labor: During the performance of this contract, the contractor shall not use convict labor for any purpose within the limits of a construction project on a Federal-aid highway unless it is labor performed by convicts who are on parole, supervised release, or probation. 23 U.S.C. 114(b). The term Federal-aid highway does not include roadways functionally classified as local roads or rural minor collectors. 23 U.S.C. 101(a).

**II. NONDISCRIMINATION** (23 CFR 230.107(a); 23 CFR Part 230, Subpart A, Appendix A; EO 11246)

The provisions of this section related to 23 CFR Part 230, Subpart A, Appendix A are applicable to all Federal-aid construction contracts and to all related construction subcontracts of \$10,000 or more. The provisions of 23 CFR Part 230 are not applicable to material supply, engineering, or architectural service contracts.

In addition, the contractor and all subcontractors must comply with the following policies: Executive Order 11246, 41 CFR Part 60, 29 CFR Parts 1625-1627, 23 U.S.C. 140, Section 504 of the Rehabilitation Act of 1973, as amended (29 U.S.C. 794), Title VI of the Civil Rights Act of 1964, as amended (42 U.S.C. 2000d et seq.), and related regulations including 49 CFR Parts 21, 26, and 27; and 23 CFR Parts 200, 230, and 633.

The contractor and all subcontractors must comply with: the requirements of the Equal Opportunity Clause in 41 CFR 60-1.4(b) and, for all construction contracts exceeding \$10,000, the Standard Federal Equal Employment Opportunity Construction Contract Specifications in 41 CFR 60-4.3.

Note: The U.S. Department of Labor has exclusive authority to determine compliance with Executive Order 11246 and the policies of the Secretary of Labor including 41 CFR Part 60, and 29 CFR Parts 1625-1627. The contracting agency and the FHWA have the authority and the responsibility to ensure compliance with 23 U.S.C. 140, Section 504 of the Rehabilitation Act of 1973, as amended (29 U.S.C. 794), and Title VI of the Civil Rights Act of 1964, as amended (42 U.S.C. 2000d et seq.), and related regulations including 49 CFR Parts 21, 26, and 27; and 23 CFR Parts 200, 230, and 633.

The following provision is adopted from 23 CFR Part 230, Subpart A, Appendix A, with appropriate revisions to conform to the U.S. Department of Labor (US DOL) and FHWA requirements.

**1. Equal Employment Opportunity:** Equal Employment Opportunity (EEO) requirements not to discriminate and to take affirmative action to assure equal opportunity as set forth under laws, executive orders, rules, regulations (see 28 CFR Part 35, 29 CFR Part 1630, 29 CFR Parts 1625-1627, 41 CFR Part 60 and 49 CFR Part 27) and orders of the Secretary of Labor as modified by the provisions prescribed herein, and imposed pursuant to 23 U.S.C. 140, shall constitute the EEO and specific affirmative action standards for the contractor's project activities under this contract. The provisions of the Americans with Disabilities Act of 1990 (42 U.S.C. 12101 et seq.) set forth under 28 CFR Part 35 and 29 CFR Part 1630 are incorporated by reference in this contract. In the execution of this contract, the contractor agrees to comply with the following minimum specific requirement activities of EEO:

a. The contractor will work with the contracting agency and the Federal Government to ensure that it has made every good faith effort to provide equal opportunity with respect to all of its terms and conditions of employment and in their review of activities under the contract. 23 CFR 230.409 (g)(4) & (5).

b. The contractor will accept as its operating policy the following statement:

"It is the policy of this Company to assure that applicants are employed, and that employees are treated during employment, without regard to their race, religion, sex, sexual orientation, gender identity, color, national origin, age or disability. Such action shall include: employment, upgrading, demotion, or transfer; recruitment or recruitment advertising; layoff or termination; rates of pay or other forms of compensation; and selection for training, including apprenticeship, pre-apprenticeship, and/or on-the-job training."

**2. EEO Officer:** The contractor will designate and make known to the contracting officers an EEO Officer who will have the responsibility for and must be capable of effectively administering and promoting an active EEO program and who must be assigned adequate authority and responsibility to do so.

**3. Dissemination of Policy:** All members of the contractor's staff who are authorized to hire, supervise, promote, and discharge employees, or who recommend such action or are substantially involved in such action, will be made fully cognizant of and will implement the contractor's EEO policy and contractual responsibilities to provide EEO in each grade and classification of employment. To ensure that the above agreement will be met, the following actions will be taken as a minimum:

a. Periodic meetings of supervisory and personnel office employees will be conducted before the start of work and then not less often than once every six months, at which time the contractor's EEO policy and its implementation will be reviewed and explained. The meetings will be conducted by the EEO Officer or other knowledgeable company official.

b. All new supervisory or personnel office employees will be given a thorough indoctrination by the EEO Officer, covering all major aspects of the contractor's EEO obligations within thirty days following their reporting for duty with the contractor.

c. All personnel who are engaged in direct recruitment for the project will be instructed by the EEO Officer in the contractor's procedures for locating and hiring minorities and women.

d. Notices and posters setting forth the contractor's EEO policy will be placed in areas readily accessible to employees, applicants for employment and potential employees.

e. The contractor's EEO policy and the procedures to implement such policy will be brought to the attention of employees by means of meetings, employee handbooks, or other appropriate means.

**4. Recruitment:** When advertising for employees, the contractor will include in all advertisements for employees the notation: "An Equal Opportunity Employer." All such advertisements will be placed in publications having a large circulation among minorities and women in the area from which the project work force would normally be derived.

a. The contractor will, unless precluded by a valid bargaining agreement, conduct systematic and direct recruitment through public and private employee referral sources likely to yield qualified minorities and women. To meet this requirement, the contractor will identify sources of potential minority group employees and establish with such identified sources procedures whereby minority and women applicants may be referred to the contractor for employment consideration.

b. In the event the contractor has a valid bargaining agreement providing for exclusive hiring hall referrals, the contractor is expected to observe the provisions of that agreement to the extent that the system meets the contractor's compliance with EEO contract provisions. Where implementation of such an agreement has the effect of discriminating against minorities or women, or obligates the contractor to do the same, such implementation violates Federal nondiscrimination provisions.

c. The contractor will encourage its present employees to refer minorities and women as applicants for employment. Information and procedures with regard to referring such applicants will be discussed with employees.

**5. Personnel Actions:** Wages, working conditions, and employee benefits shall be established and administered, and personnel actions of every type, including hiring, upgrading, promotion, transfer, demotion, layoff, and termination, shall be taken without regard to race, color, religion, sex, sexual orientation, gender identity, national origin, age or disability. The following procedures shall be followed:

a. The contractor will conduct periodic inspections of project sites to ensure that working conditions and employee facilities do not indicate discriminatory treatment of project site personnel.

b. The contractor will periodically evaluate the spread of wages paid within each classification to determine any evidence of discriminatory wage practices.

c. The contractor will periodically review selected personnel actions in depth to determine whether there is evidence of discrimination. Where evidence is found, the contractor will promptly take corrective action. If the review indicates that the discrimination may extend beyond the actions reviewed, such corrective action shall include all affected persons.

d. The contractor will promptly investigate all complaints of alleged discrimination made to the contractor in connection with its obligations under this contract, will attempt to resolve such complaints, and will take appropriate corrective action

within a reasonable time. If the investigation indicates that the discrimination may affect persons other than the complainant, such corrective action shall include such other persons. Upon completion of each investigation, the contractor will inform every complainant of all of their avenues of appeal.

#### **6. Training and Promotion:**

a. The contractor will assist in locating, qualifying, and increasing the skills of minorities and women who are applicants for employment or current employees. Such efforts should be aimed at developing full journey level status employees in the type of trade or job classification involved.

b. Consistent with the contractor's work force requirements and as permissible under Federal and State regulations, the contractor shall make full use of training programs (i.e., apprenticeship and on-the-job training programs for the geographical area of contract performance). In the event a special provision for training is provided under this contract, this subparagraph will be superseded as indicated in the special provision. The contracting agency may reserve training positions for persons who receive welfare assistance in accordance with 23 U.S.C. 140(a).

c. The contractor will advise employees and applicants for employment of available training programs and entrance requirements for each.

d. The contractor will periodically review the training and promotion potential of employees who are minorities and women and will encourage eligible employees to apply for such training and promotion.

**7. Unions:** If the contractor relies in whole or in part upon unions as a source of employees, the contractor will use good faith efforts to obtain the cooperation of such unions to increase opportunities for minorities and women. 23 CFR 230.409. Actions by the contractor, either directly or through a contractor's association acting as agent, will include the procedures set forth below:

a. The contractor will use good faith efforts to develop, in cooperation with the unions, joint training programs aimed toward qualifying more minorities and women for membership in the unions and increasing the skills of minorities and women so that they may qualify for higher paying employment.

b. The contractor will use good faith efforts to incorporate an EEO clause into each union agreement to the end that such union will be contractually bound to refer applicants without regard to their race, color, religion, sex, sexual orientation, gender identity, national origin, age, or disability.

c. The contractor is to obtain information as to the referral practices and policies of the labor union except that to the extent such information is within the exclusive possession of the labor union and such labor union refuses to furnish such information to the contractor, the contractor shall so certify to the contracting agency and shall set forth what efforts have been made to obtain such information.

d. In the event the union is unable to provide the contractor with a reasonable flow of referrals within the time limit set forth in the collective bargaining agreement, the contractor will, through independent recruitment efforts, fill the employment vacancies without regard to race, color, religion, sex, sexual orientation, gender identity, national origin, age, or disability; making full efforts to obtain qualified and/or qualifiable minorities and women. The failure of a union to provide

sufficient referrals (even though it is obligated to provide exclusive referrals under the terms of a collective bargaining agreement) does not relieve the contractor from the requirements of this paragraph. In the event the union referral practice prevents the contractor from meeting the obligations pursuant to Executive Order 11246, as amended, and these special provisions, such contractor shall immediately notify the contracting agency.

**8. Reasonable Accommodation for Applicants / Employees with Disabilities:** The contractor must be familiar with the requirements for and comply with the Americans with Disabilities Act and all rules and regulations established thereunder. Employers must provide reasonable accommodation in all employment activities unless to do so would cause an undue hardship.

**9. Selection of Subcontractors, Procurement of Materials and Leasing of Equipment:** The contractor shall not discriminate on the grounds of race, color, religion, sex, sexual orientation, gender identity, national origin, age, or disability in the selection and retention of subcontractors, including procurement of materials and leases of equipment. The contractor shall take all necessary and reasonable steps to ensure nondiscrimination in the administration of this contract.

a. The contractor shall notify all potential subcontractors, suppliers, and lessors of their EEO obligations under this contract.

b. The contractor will use good faith efforts to ensure subcontractor compliance with their EEO obligations.

#### **10. Assurances Required:**

a. The requirements of 49 CFR Part 26 and the State DOT's FHWA-approved Disadvantaged Business Enterprise (DBE) program are incorporated by reference.

b. The contractor, subrecipient or subcontractor shall not discriminate on the basis of race, color, national origin, or sex in the performance of this contract. The contractor shall carry out applicable requirements of 49 CFR part 26 in the award and administration of DOT-assisted contracts. Failure by the contractor to carry out these requirements is a material breach of this contract, which may result in the termination of this contract or such other remedy as the recipient deems appropriate, which may include, but is not limited to:

- (1) Withholding monthly progress payments;
- (2) Assessing sanctions;
- (3) Liquidated damages; and/or
- (4) Disqualifying the contractor from future bidding as non-responsible.

c. The Title VI and nondiscrimination provisions of U.S. DOT Order 1050.2A at Appendixes A and E are incorporated by reference. 49 CFR Part 21.

**11. Records and Reports:** The contractor shall keep such records as necessary to document compliance with the EEO requirements. Such records shall be retained for a period of three years following the date of the final payment to the contractor for all contract work and shall be available at reasonable times and places for inspection by authorized representatives of the contracting agency and the FHWA.

a. The records kept by the contractor shall document the following:

(1) The number and work hours of minority and non-minority group members and women employed in each work classification on the project;

(2) The progress and efforts being made in cooperation with unions, when applicable, to increase employment opportunities for minorities and women; and

(3) The progress and efforts being made in locating, hiring, training, qualifying, and upgrading minorities and women.

b. The contractors and subcontractors will submit an annual report to the contracting agency each July for the duration of the project indicating the number of minority, women, and non-minority group employees currently engaged in each work classification required by the contract work. This information is to be reported on [Form FHWA-1391](#). The staffing data should represent the project work force on board in all or any part of the last payroll period preceding the end of July. If on-the-job training is being required by special provision, the contractor will be required to collect and report training data. The employment data should reflect the work force on board during all or any part of the last payroll period preceding the end of July.

### III. NONSEGREGATED FACILITIES

This provision is applicable to all Federal-aid construction contracts and to all related construction subcontracts of more than \$10,000. 41 CFR 60-1.5.

As prescribed by 41 CFR 60-1.8, the contractor must ensure that facilities provided for employees are provided in such a manner that segregation on the basis of race, color, religion, sex, sexual orientation, gender identity, or national origin cannot result. The contractor may neither require such segregated use by written or oral policies nor tolerate such use by employee custom. The contractor's obligation extends further to ensure that its employees are not assigned to perform their services at any location under the contractor's control where the facilities are segregated. The term "facilities" includes waiting rooms, work areas, restaurants and other eating areas, time clocks, restrooms, washrooms, locker rooms and other storage or dressing areas, parking lots, drinking fountains, recreation or entertainment areas, transportation, and housing provided for employees. The contractor shall provide separate or single-user restrooms and necessary dressing or sleeping areas to assure privacy between sexes.

### IV. DAVIS-BACON AND RELATED ACT PROVISIONS

This section is applicable to all Federal-aid construction projects exceeding \$2,000 and to all related subcontracts and lower-tier subcontracts (regardless of subcontract size), in accordance with 29 CFR 5.5. The requirements apply to all projects located within the right-of-way of a roadway that is functionally classified as Federal-aid highway. 23 U.S.C. 113. This excludes roadways functionally classified as local roads or rural minor collectors, which are exempt. 23 U.S.C. 101. Where applicable law requires that projects be treated as a project on a Federal-aid highway, the provisions of this subpart will apply regardless of the location of the project. Examples include: Surface Transportation Block Grant Program projects funded under 23 U.S.C. 133 [excluding recreational trails projects], the Nationally Significant Freight and Highway

Projects funded under 23 U.S.C. 117, and National Highway Freight Program projects funded under 23 U.S.C. 167.

The following provisions are from the U.S. Department of Labor regulations in 29 CFR 5.5 "Contract provisions and related matters" with minor revisions to conform to the FHWA-1273 format and FHWA program requirements.

#### 1. Minimum wages (29 CFR 5.5)

a. All laborers and mechanics employed or working upon the site of the work, will be paid unconditionally and not less often than once a week, and without subsequent deduction or rebate on any account (except such payroll deductions as are permitted by regulations issued by the Secretary of Labor under the Copeland Act (29 CFR part 3)), the full amount of wages and bona fide fringe benefits (or cash equivalents thereof) due at time of payment computed at rates not less than those contained in the wage determination of the Secretary of Labor which is attached hereto and made a part hereof, regardless of any contractual relationship which may be alleged to exist between the contractor and such laborers and mechanics.

Contributions made or costs reasonably anticipated for bona fide fringe benefits under section 1(b)(2) of the Davis-Bacon Act on behalf of laborers or mechanics are considered wages paid to such laborers or mechanics, subject to the provisions of paragraph 1.d. of this section; also, regular contributions made or costs incurred for more than a weekly period (but not less often than quarterly) under plans, funds, or programs which cover the particular weekly period, are deemed to be constructively made or incurred during such weekly period. Such laborers and mechanics shall be paid the appropriate wage rate and fringe benefits on the wage determination for the classification of work actually performed, without regard to skill, except as provided in 29 CFR 5.5(a)(4). Laborers or mechanics performing work in more than one classification may be compensated at the rate specified for each classification for the time actually worked therein: Provided, That the employer's payroll records accurately set forth the time spent in each classification in which work is performed. The wage determination (including any additional classification and wage rates conformed under paragraph 1.b. of this section) and the Davis-Bacon poster (WH-1321) shall be posted at all times by the contractor and its subcontractors at the site of the work in a prominent and accessible place where it can be easily seen by the workers.

b.(1) The contracting officer shall require that any class of laborers or mechanics, including helpers, which is not listed in the wage determination and which is to be employed under the contract shall be classified in conformance with the wage determination. The contracting officer shall approve an additional classification and wage rate and fringe benefits therefore only when the following criteria have been met:

(i) The work to be performed by the classification requested is not performed by a classification in the wage determination; and

(ii) The classification is utilized in the area by the construction industry; and



(iii) The proposed wage rate, including any bona fide fringe benefits, bears a reasonable relationship to the wage rates contained in the wage determination.

(2) If the contractor and the laborers and mechanics to be employed in the classification (if known), or their representatives, and the contracting officer agree on the classification and wage rate (including the amount designated for fringe benefits where appropriate), a report of the action taken shall be sent by the contracting officer to the Administrator of the Wage and Hour Division, U.S. Department of Labor, Washington, DC 20210. The Administrator, or an authorized representative, will approve, modify, or disapprove every additional classification action within 30 days of receipt and so advise the contracting officer or will notify the contracting officer within the 30-day period that additional time is necessary.

(3) In the event the contractor, the laborers or mechanics to be employed in the classification or their representatives, and the contracting officer do not agree on the proposed classification and wage rate (including the amount designated for fringe benefits, where appropriate), the contracting officer shall refer the questions, including the views of all interested parties and the recommendation of the contracting officer, to the Administrator for determination. The Administrator, or an authorized representative, will issue a determination within 30 days of receipt and so advise the contracting officer or will notify the contracting officer within the 30-day period that additional time is necessary.

(4) The wage rate (including fringe benefits where appropriate) determined pursuant to paragraphs 1.b.(2) or 1.b.(3) of this section, shall be paid to all workers performing work in the classification under this contract from the first day on which work is performed in the classification.

c. Whenever the minimum wage rate prescribed in the contract for a class of laborers or mechanics includes a fringe benefit which is not expressed as an hourly rate, the contractor shall either pay the benefit as stated in the wage determination or shall pay another bona fide fringe benefit or an hourly cash equivalent thereof.

d. If the contractor does not make payments to a trustee or other third person, the contractor may consider as part of the wages of any laborer or mechanic the amount of any costs reasonably anticipated in providing bona fide fringe benefits under a plan or program, Provided, That the Secretary of Labor has found, upon the written request of the contractor, that the applicable standards of the Davis-Bacon Act have been met. The Secretary of Labor may require the contractor to set aside in a separate account assets for the meeting of obligations under the plan or program.

## 2. Withholding (29 CFR 5.5)

The contracting agency shall upon its own action or upon written request of an authorized representative of the Department of Labor, withhold or cause to be withheld from the contractor under this contract, or any other Federal contract with the same prime contractor, or any other federally-assisted contract subject to Davis-Bacon prevailing wage requirements, which is held by the same prime contractor, so much of the accrued payments or advances as may be considered necessary to pay laborers and mechanics,

including apprentices, trainees, and helpers, employed by the contractor or any subcontractor the full amount of wages required by the contract. In the event of failure to pay any laborer or mechanic, including any apprentice, trainee, or helper, employed or working on the site of the work, all or part of the wages required by the contract, the contracting agency may, after written notice to the contractor, take such action as may be necessary to cause the suspension of any further payment, advance, or guarantee of funds until such violations have ceased.

## 3. Payrolls and basic records (29 CFR 5.5)

a. Payrolls and basic records relating thereto shall be maintained by the contractor during the course of the work and preserved for a period of three years thereafter for all laborers and mechanics working at the site of the work. Such records shall contain the name, address, and social security number of each such worker, his or her correct classification, hourly rates of wages paid (including rates of contributions or costs anticipated for bona fide fringe benefits or cash equivalents thereof of the types described in section 1(b)(2)(B) of the Davis-Bacon Act), daily and weekly number of hours worked, deductions made and actual wages paid. Whenever the Secretary of Labor has found under 29 CFR 5.5(a)(1)(iv) that the wages of any laborer or mechanic include the amount of any costs reasonably anticipated in providing benefits under a plan or program described in section 1(b)(2)(B) of the Davis-Bacon Act, the contractor shall maintain records which show that the commitment to provide such benefits is enforceable, that the plan or program is financially responsible, and that the plan or program has been communicated in writing to the laborers or mechanics affected, and records which show the costs anticipated or the actual cost incurred in providing such benefits. Contractors employing apprentices or trainees under approved programs shall maintain written evidence of the registration of apprenticeship programs and certification of trainee programs, the registration of the apprentices and trainees, and the ratios and wage rates prescribed in the applicable programs.

b.(1) The contractor shall submit weekly for each week in which any contract work is performed a copy of all payrolls to the contracting agency. The payrolls submitted shall set out accurately and completely all of the information required to be maintained under 29 CFR 5.5(a)(3)(i), except that full social security numbers and home addresses shall not be included on weekly transmittals. Instead the payrolls shall only need to include an individually identifying number for each employee (e.g., the last four digits of the employee's social security number). The required weekly payroll information may be submitted in any form desired. Optional Form WH-347 is available for this purpose from the Wage and Hour Division Web site. The prime contractor is responsible for the submission of copies of payrolls by all subcontractors. Contractors and subcontractors shall maintain the full social security number and current address of each covered worker, and shall provide them upon request to the contracting agency for transmission to the State DOT, the FHWA or the Wage and Hour Division of the Department of Labor for purposes of an investigation or audit of compliance with prevailing wage requirements. It is not a violation of this section for a prime contractor to require a subcontractor to provide addresses and social security numbers to the prime contractor for its own records, without weekly submission to the contracting agency.

(2) Each payroll submitted shall be accompanied by a "Statement of Compliance," signed by the contractor or

subcontractor or his or her agent who pays or supervises the payment of the persons employed under the contract and shall certify the following:

(i) That the payroll for the payroll period contains the information required to be provided under 29 CFR 5.5(a)(3)(ii), the appropriate information is being maintained under 29 CFR 5.5(a)(3)(i), and that such information is correct and complete;

(ii) That each laborer or mechanic (including each helper, apprentice, and trainee) employed on the contract during the payroll period has been paid the full weekly wages earned, without rebate, either directly or indirectly, and that no deductions have been made either directly or indirectly from the full wages earned, other than permissible deductions as set forth in 29 CFR part 3;

(iii) That each laborer or mechanic has been paid not less than the applicable wage rates and fringe benefits or cash equivalents for the classification of work performed, as specified in the applicable wage determination incorporated into the contract.

(3) The weekly submission of a properly executed certification set forth on the reverse side of Optional Form WH-347 shall satisfy the requirement for submission of the "Statement of Compliance" required by paragraph 3.b.(2) of this section.

(4) The falsification of any of the above certifications may subject the contractor or subcontractor to civil or criminal prosecution under 18 U.S.C. 1001 and 31 U.S.C. 231.

c. The contractor or subcontractor shall make the records required under paragraph 3.a. of this section available for inspection, copying, or transcription by authorized representatives of the contracting agency, the State DOT, the FHWA, or the Department of Labor, and shall permit such representatives to interview employees during working hours on the job. If the contractor or subcontractor fails to submit the required records or to make them available, the FHWA may, after written notice to the contractor, the contracting agency or the State DOT, take such action as may be necessary to cause the suspension of any further payment, advance, or guarantee of funds. Furthermore, failure to submit the required records upon request or to make such records available may be grounds for debarment action pursuant to 29 CFR 5.12.

#### 4. Apprentices and trainees (29 CFR 5.5)

##### a. Apprentices (programs of the USDOL).

Apprentices will be permitted to work at less than the predetermined rate for the work they performed when they are employed pursuant to and individually registered in a bona fide apprenticeship program registered with the U.S. Department of Labor, Employment and Training Administration, Office of Apprenticeship Training, Employer and Labor Services, or with a State Apprenticeship Agency recognized by the Office, or if a person is employed in his or her first 90 days of probationary employment as an apprentice in such an apprenticeship program, who is not individually registered in the program, but who has been certified by the Office of Apprenticeship Training, Employer and Labor Services or a State

Apprenticeship Agency (where appropriate) to be eligible for probationary employment as an apprentice.

The allowable ratio of apprentices to journeymen on the job site in any craft classification shall not be greater than the ratio permitted to the contractor as to the entire work force under the registered program. Any worker listed on a payroll at an apprentice wage rate, who is not registered or otherwise employed as stated above, shall be paid not less than the applicable wage rate on the wage determination for the classification of work actually performed. In addition, any apprentice performing work on the job site in excess of the ratio permitted under the registered program shall be paid not less than the applicable wage rate on the wage determination for the work actually performed. Where a contractor is performing construction on a project in a locality other than that in which its program is registered, the ratios and wage rates (expressed in percentages of the journeyman's hourly rate) specified in the contractor's or subcontractor's registered program shall be observed.

Every apprentice must be paid at not less than the rate specified in the registered program for the apprentice's level of progress, expressed as a percentage of the journeymen hourly rate specified in the applicable wage determination. Apprentices shall be paid fringe benefits in accordance with the provisions of the apprenticeship program. If the apprenticeship program does not specify fringe benefits, apprentices must be paid the full amount of fringe benefits listed on the wage determination for the applicable classification. If the Administrator determines that a different practice prevails for the applicable apprentice classification, fringes shall be paid in accordance with that determination.

In the event the Office of Apprenticeship Training, Employer and Labor Services, or a State Apprenticeship Agency recognized by the Office, withdraws approval of an apprenticeship program, the contractor will no longer be permitted to utilize apprentices at less than the applicable predetermined rate for the work performed until an acceptable program is approved.

##### b. Trainees (programs of the USDOL).

Except as provided in 29 CFR 5.16, trainees will not be permitted to work at less than the predetermined rate for the work performed unless they are employed pursuant to and individually registered in a program which has received prior approval, evidenced by formal certification by the U.S. Department of Labor, Employment and Training Administration.

The ratio of trainees to journeymen on the job site shall not be greater than permitted under the plan approved by the Employment and Training Administration.

Every trainee must be paid at not less than the rate specified in the approved program for the trainee's level of progress, expressed as a percentage of the journeyman hourly rate specified in the applicable wage determination. Trainees shall be paid fringe benefits in accordance with the provisions of the trainee program. If the trainee program does not mention fringe benefits, trainees shall be paid the full amount of fringe benefits listed on the wage determination unless the Administrator of the Wage and Hour Division determines that there is an apprenticeship program associated with the

corresponding journeyman wage rate on the wage determination which provides for less than full fringe benefits for apprentices. Any employee listed on the payroll at a trainee rate who is not registered and participating in a training plan approved by the Employment and Training Administration shall be paid not less than the applicable wage rate on the wage determination for the classification of work actually performed. In addition, any trainee performing work on the job site in excess of the ratio permitted under the registered program shall be paid not less than the applicable wage rate on the wage determination for the work actually performed.

In the event the Employment and Training Administration withdraws approval of a training program, the contractor will no longer be permitted to utilize trainees at less than the applicable predetermined rate for the work performed until an acceptable program is approved.

c. Equal employment opportunity. The utilization of apprentices, trainees and journeymen under this part shall be in conformity with the equal employment opportunity requirements of Executive Order 11246, as amended, and 29 CFR part 30.

d. Apprentices and Trainees (programs of the U.S. DOT).

Apprentices and trainees working under apprenticeship and skill training programs which have been certified by the Secretary of Transportation as promoting EEO in connection with Federal-aid highway construction programs are not subject to the requirements of paragraph 4 of this Section IV. 23 CFR 230.111(e)(2). The straight time hourly wage rates for apprentices and trainees under such programs will be established by the particular programs. The ratio of apprentices and trainees to journeymen shall not be greater than permitted by the terms of the particular program.

**5. Compliance with Copeland Act requirements.** The contractor shall comply with the requirements of 29 CFR part 3, which are incorporated by reference in this contract as provided in 29 CFR 5.5.

**6. Subcontracts.** The contractor or subcontractor shall insert Form FHWA-1273 in any subcontracts and also require the subcontractors to include Form FHWA-1273 in any lower tier subcontracts. The prime contractor shall be responsible for the compliance by any subcontractor or lower tier subcontractor with all the contract clauses in 29 CFR 5.5.

**7. Contract termination: debarment.** A breach of the contract clauses in 29 CFR 5.5 may be grounds for termination of the contract, and for debarment as a contractor and a subcontractor as provided in 29 CFR 5.12.

**8. Compliance with Davis-Bacon and Related Act requirements.** All rulings and interpretations of the Davis-Bacon and Related Acts contained in 29 CFR parts 1, 3, and 5 are herein incorporated by reference in this contract as provided in 29 CFR 5.5.

**9. Disputes concerning labor standards.** As provided in 29 CFR 5.5, disputes arising out of the labor standards provisions of this contract shall not be subject to the general disputes clause of this contract. Such disputes shall be resolved in accordance with the procedures of the Department of Labor

set forth in 29 CFR parts 5, 6, and 7. Disputes within the meaning of this clause include disputes between the contractor (or any of its subcontractors) and the contracting agency, the U.S. Department of Labor, or the employees or their representatives.

#### **10. Certification of eligibility (29 CFR 5.5)**

a. By entering into this contract, the contractor certifies that neither it (nor he or she) nor any person or firm who has an interest in the contractor's firm is a person or firm ineligible to be awarded Government contracts by virtue of section 3(a) of the Davis-Bacon Act or 29 CFR 5.12(a)(1).

b. No part of this contract shall be subcontracted to any person or firm ineligible for award of a Government contract by virtue of section 3(a) of the Davis-Bacon Act or 29 CFR 5.12(a)(1).

c. The penalty for making false statements is prescribed in the U.S. Criminal Code, 18 U.S.C. 1001.

#### **V. CONTRACT WORK HOURS AND SAFETY STANDARDS ACT**

Pursuant to 29 CFR 5.5(b), the following clauses apply to any Federal-aid construction contract in an amount in excess of \$100,000 and subject to the overtime provisions of the Contract Work Hours and Safety Standards Act. These clauses shall be inserted in addition to the clauses required by 29 CFR 5.5(a) or 29 CFR 4.6. As used in this paragraph, the terms laborers and mechanics include watchmen and guards.

**1. Overtime requirements.** No contractor or subcontractor contracting for any part of the contract work which may require or involve the employment of laborers or mechanics shall require or permit any such laborer or mechanic in any workweek in which he or she is employed on such work to work in excess of forty hours in such workweek unless such laborer or mechanic receives compensation at a rate not less than one and one-half times the basic rate of pay for all hours worked in excess of forty hours in such workweek. 29 CFR 5.5.

**2. Violation; liability for unpaid wages; liquidated damages.** In the event of any violation of the clause set forth in paragraph 1 of this section, the contractor and any subcontractor responsible therefor shall be liable for the unpaid wages. In addition, such contractor and subcontractor shall be liable to the United States (in the case of work done under contract for the District of Columbia or a territory, to such District or to such territory), for liquidated damages. Such liquidated damages shall be computed with respect to each individual laborer or mechanic, including watchmen and guards, employed in violation of the clause set forth in paragraph 1 of this section, in the sum currently provided in 29 CFR 5.5(b)(2)\* for each calendar day on which such individual was required or permitted to work in excess of the standard workweek of forty hours without payment of the overtime wages required by the clause set forth in paragraph 1 of this section. 29 CFR 5.5.

\* \$27 as of January 23, 2019 (See 84 FR 213-01, 218) as may be adjusted annually by the Department of Labor; pursuant to the Federal Civil Penalties Inflation Adjustment Act of 1990).

### **3. Withholding for unpaid wages and liquidated damages.**

The FHWA or the contracting agency shall upon its own action or upon written request of an authorized representative of the Department of Labor withhold or cause to be withheld, from any moneys payable on account of work performed by the contractor or subcontractor under any such contract or any other Federal contract with the same prime contractor, or any other federally-assisted contract subject to the Contract Work Hours and Safety Standards Act, which is held by the same prime contractor, such sums as may be determined to be necessary to satisfy any liabilities of such contractor or subcontractor for unpaid wages and liquidated damages as provided in the clause set forth in paragraph 2 of this section. 29 CFR 5.5.

**4. Subcontracts.** The contractor or subcontractor shall insert in any subcontracts the clauses set forth in paragraphs 1 through 4 of this section and also a clause requiring the subcontractors to include these clauses in any lower tier subcontracts. The prime contractor shall be responsible for compliance by any subcontractor or lower tier subcontractor with the clauses set forth in paragraphs 1 through 4 of this section. 29 CFR 5.5.

## **VI. SUBLETTING OR ASSIGNING THE CONTRACT**

This provision is applicable to all Federal-aid construction contracts on the National Highway System pursuant to 23 CFR 635.116.

1. The contractor shall perform with its own organization contract work amounting to not less than 30 percent (or a greater percentage if specified elsewhere in the contract) of the total original contract price, excluding any specialty items designated by the contracting agency. Specialty items may be performed by subcontract and the amount of any such specialty items performed may be deducted from the total original contract price before computing the amount of work required to be performed by the contractor's own organization (23 CFR 635.116).

a. The term "perform work with its own organization" in paragraph 1 of Section VI refers to workers employed or leased by the prime contractor, and equipment owned or rented by the prime contractor, with or without operators. Such term does not include employees or equipment of a subcontractor or lower tier subcontractor, agents of the prime contractor, or any other assignees. The term may include payments for the costs of hiring leased employees from an employee leasing firm meeting all relevant Federal and State regulatory requirements. Leased employees may only be included in this term if the prime contractor meets all of the following conditions: (based on longstanding interpretation)

- (1) the prime contractor maintains control over the supervision of the day-to-day activities of the leased employees;
- (2) the prime contractor remains responsible for the quality of the work of the leased employees;
- (3) the prime contractor retains all power to accept or exclude individual employees from work on the project; and
- (4) the prime contractor remains ultimately responsible for the payment of predetermined minimum wages, the submission of payrolls, statements of compliance and all other Federal regulatory requirements.

b. "Specialty Items" shall be construed to be limited to work that requires highly specialized knowledge, abilities, or

equipment not ordinarily available in the type of contracting organizations qualified and expected to bid or propose on the contract as a whole and in general are to be limited to minor components of the overall contract. 23 CFR 635.102.

2. Pursuant to 23 CFR 635.116(a), the contract amount upon which the requirements set forth in paragraph (1) of Section VI is computed includes the cost of material and manufactured products which are to be purchased or produced by the contractor under the contract provisions.

3. Pursuant to 23 CFR 635.116(c), the contractor shall furnish (a) a competent superintendent or supervisor who is employed by the firm, has full authority to direct performance of the work in accordance with the contract requirements, and is in charge of all construction operations (regardless of who performs the work) and (b) such other of its own organizational resources (supervision, management, and engineering services) as the contracting officer determines is necessary to assure the performance of the contract.

4. No portion of the contract shall be sublet, assigned or otherwise disposed of except with the written consent of the contracting officer, or authorized representative, and such consent when given shall not be construed to relieve the contractor of any responsibility for the fulfillment of the contract. Written consent will be given only after the contracting agency has assured that each subcontract is evidenced in writing and that it contains all pertinent provisions and requirements of the prime contract. (based on longstanding interpretation of 23 CFR 635.116).

5. The 30-percent self-performance requirement of paragraph (1) is not applicable to design-build contracts; however, contracting agencies may establish their own self-performance requirements. 23 CFR 635.116(d).

## **VII. SAFETY: ACCIDENT PREVENTION**

This provision is applicable to all Federal-aid construction contracts and to all related subcontracts.

1. In the performance of this contract the contractor shall comply with all applicable Federal, State, and local laws governing safety, health, and sanitation (23 CFR Part 635). The contractor shall provide all safeguards, safety devices and protective equipment and take any other needed actions as it determines, or as the contracting officer may determine, to be reasonably necessary to protect the life and health of employees on the job and the safety of the public and to protect property in connection with the performance of the work covered by the contract. 23 CFR 635.108.

2. It is a condition of this contract, and shall be made a condition of each subcontract, which the contractor enters into pursuant to this contract, that the contractor and any subcontractor shall not permit any employee, in performance of the contract, to work in surroundings or under conditions which are unsanitary, hazardous or dangerous to his/her health or safety, as determined under construction safety and health standards (29 CFR Part 1926) promulgated by the Secretary of Labor, in accordance with Section 107 of the Contract Work Hours and Safety Standards Act (40 U.S.C. 3704). 29 CFR 1926.10.

3. Pursuant to 29 CFR 1926.3, it is a condition of this contract that the Secretary of Labor or authorized representative thereof, shall have right of entry to any site of contract performance to inspect or investigate the matter of compliance

with the construction safety and health standards and to carry out the duties of the Secretary under Section 107 of the Contract Work Hours and Safety Standards Act (40 U.S.C. 3704).

### **VIII. FALSE STATEMENTS CONCERNING HIGHWAY PROJECTS**

This provision is applicable to all Federal-aid construction contracts and to all related subcontracts.

In order to assure high quality and durable construction in conformity with approved plans and specifications and a high degree of reliability on statements and representations made by engineers, contractors, suppliers, and workers on Federal-aid highway projects, it is essential that all persons concerned with the project perform their functions as carefully, thoroughly, and honestly as possible. Willful falsification, distortion, or misrepresentation with respect to any facts related to the project is a violation of Federal law. To prevent any misunderstanding regarding the seriousness of these and similar acts, Form FHWA-1022 shall be posted on each Federal-aid highway project (23 CFR Part 635) in one or more places where it is readily available to all persons concerned with the project:

18 U.S.C. 1020 reads as follows:

"Whoever, being an officer, agent, or employee of the United States, or of any State or Territory, or whoever, whether a person, association, firm, or corporation, knowingly makes any false statement, false representation, or false report as to the character, quality, quantity, or cost of the material used or to be used, or the quantity or quality of the work performed or to be performed, or the cost thereof in connection with the submission of plans, maps, specifications, contracts, or costs of construction on any highway or related project submitted for approval to the Secretary of Transportation; or

Whoever knowingly makes any false statement, false representation, false report or false claim with respect to the character, quality, quantity, or cost of any work performed or to be performed, or materials furnished or to be furnished, in connection with the construction of any highway or related project approved by the Secretary of Transportation; or

Whoever knowingly makes any false statement or false representation as to material fact in any statement, certificate, or report submitted pursuant to provisions of the Federal-aid Roads Act approved July 11, 1916, (39 Stat. 355), as amended and supplemented;

Shall be fined under this title or imprisoned not more than 5 years or both."

### **IX. IMPLEMENTATION OF CLEAN AIR ACT AND FEDERAL WATER POLLUTION CONTROL ACT (42 U.S.C. 7606; 2 CFR 200.88; EO 11738)**

This provision is applicable to all Federal-aid construction contracts in excess of \$150,000 and to all related subcontracts. 48 CFR 2.101; 2 CFR 200.326.

By submission of this bid/proposal or the execution of this contract or subcontract, as appropriate, the bidder, proposer, Federal-aid construction contractor, subcontractor, supplier, or vendor agrees to comply with all applicable standards, orders

or regulations issued pursuant to the Clean Air Act (42 U.S.C. 7401-7671q) and the Federal Water Pollution Control Act, as amended (33 U.S.C. 1251-1387). Violations must be reported to the Federal Highway Administration and the Regional Office of the Environmental Protection Agency. 2 CFR Part 200, Appendix II.

The contractor agrees to include or cause to be included the requirements of this Section in every subcontract, and further agrees to take such action as the contracting agency may direct as a means of enforcing such requirements. 2 CFR 200.326.

### **X. CERTIFICATION REGARDING DEBARMENT, SUSPENSION, INELIGIBILITY AND VOLUNTARY EXCLUSION**

This provision is applicable to all Federal-aid construction contracts, design-build contracts, subcontracts, lower-tier subcontracts, purchase orders, lease agreements, consultant contracts or any other covered transaction requiring FHWA approval or that is estimated to cost \$25,000 or more – as defined in 2 CFR Parts 180 and 1200. 2 CFR 180.220 and 1200.220.

#### **1. Instructions for Certification – First Tier Participants:**

a. By signing and submitting this proposal, the prospective first tier participant is providing the certification set out below.

b. The inability of a person to provide the certification set out below will not necessarily result in denial of participation in this covered transaction. The prospective first tier participant shall submit an explanation of why it cannot provide the certification set out below. The certification or explanation will be considered in connection with the department or agency's determination whether to enter into this transaction. However, failure of the prospective first tier participant to furnish a certification or an explanation shall disqualify such a person from participation in this transaction. 2 CFR 180.320.

c. The certification in this clause is a material representation of fact upon which reliance was placed when the contracting agency determined to enter into this transaction. If it is later determined that the prospective participant knowingly rendered an erroneous certification, in addition to other remedies available to the Federal Government, the contracting agency may terminate this transaction for cause of default. 2 CFR 180.325.

d. The prospective first tier participant shall provide immediate written notice to the contracting agency to whom this proposal is submitted if any time the prospective first tier participant learns that its certification was erroneous when submitted or has become erroneous by reason of changed circumstances. 2 CFR 180.345 and 180.350.

e. The terms "covered transaction," "debarred," "suspended," "ineligible," "participant," "person," "principal," and "voluntarily excluded," as used in this clause, are defined in 2 CFR Parts 180, Subpart I, 180.900-180.1020, and 1200. "First Tier Covered Transactions" refers to any covered transaction between a recipient or subrecipient of Federal funds and a participant (such as the prime or general contract). "Lower Tier Covered Transactions" refers to any covered transaction under a First Tier Covered Transaction (such as subcontracts). "First Tier Participant" refers to the participant

who has entered into a covered transaction with a recipient or subrecipient of Federal funds (such as the prime or general contractor). "Lower Tier Participant" refers any participant who has entered into a covered transaction with a First Tier Participant or other Lower Tier Participants (such as subcontractors and suppliers).

f. The prospective first tier participant agrees by submitting this proposal that, should the proposed covered transaction be entered into, it shall not knowingly enter into any lower tier covered transaction with a person who is debarred, suspended, declared ineligible, or voluntarily excluded from participation in this covered transaction, unless authorized by the department or agency entering into this transaction. 2 CFR 180.330.

g. The prospective first tier participant further agrees by submitting this proposal that it will include the clause titled "Certification Regarding Debarment, Suspension, Ineligibility and Voluntary Exclusion-Lower Tier Covered Transactions," provided by the department or contracting agency, entering into this covered transaction, without modification, in all lower tier covered transactions and in all solicitations for lower tier covered transactions exceeding the \$25,000 threshold. 2 CFR 180.220 and 180.300.

h. A participant in a covered transaction may rely upon a certification of a prospective participant in a lower tier covered transaction that is not debarred, suspended, ineligible, or voluntarily excluded from the covered transaction, unless it knows that the certification is erroneous. 2 CFR 180.300; 180.320, and 180.325. A participant is responsible for ensuring that its principals are not suspended, debarred, or otherwise ineligible to participate in covered transactions. 2 CFR 180.335. To verify the eligibility of its principals, as well as the eligibility of any lower tier prospective participants, each participant may, but is not required to, check the System for Award Management website (<https://www.sam.gov/>). 2 CFR 180.300, 180.320, and 180.325.

i. Nothing contained in the foregoing shall be construed to require the establishment of a system of records in order to render in good faith the certification required by this clause. The knowledge and information of the prospective participant is not required to exceed that which is normally possessed by a prudent person in the ordinary course of business dealings.

j. Except for transactions authorized under paragraph (f) of these instructions, if a participant in a covered transaction knowingly enters into a lower tier covered transaction with a person who is suspended, debarred, ineligible, or voluntarily excluded from participation in this transaction, in addition to other remedies available to the Federal Government, the department or agency may terminate this transaction for cause or default. 2 CFR 180.325.

\*\*\*\*\*

## **2. Certification Regarding Debarment, Suspension, Ineligibility and Voluntary Exclusion – First Tier Participants:**

a. The prospective first tier participant certifies to the best of its knowledge and belief, that it and its principals:

(1) Are not presently debarred, suspended, proposed for debarment, declared ineligible, or voluntarily excluded from participating in covered transactions by any Federal department or agency, 2 CFR 180.335;.

(2) Have not within a three-year period preceding this proposal been convicted of or had a civil judgment rendered against them for commission of fraud or a criminal offense in connection with obtaining, attempting to obtain, or performing a public (Federal, State, or local) transaction or contract under a public transaction; violation of Federal or State antitrust statutes or commission of embezzlement, theft, forgery, bribery, falsification or destruction of records, making false statements, or receiving stolen property, 2 CFR 180.800;

(3) Are not presently indicted for or otherwise criminally or civilly charged by a governmental entity (Federal, State or local) with commission of any of the offenses enumerated in paragraph (a)(2) of this certification, 2 CFR 180.700 and 180.800; and

(4) Have not within a three-year period preceding this application/proposal had one or more public transactions (Federal, State or local) terminated for cause or default. 2 CFR 180.335(d).

(5) Are not a corporation that has been convicted of a felony violation under any Federal law within the two-year period preceding this proposal (USDOT Order 4200.6 implementing appropriations act requirements); and

(6) Are not a corporation with any unpaid Federal tax liability that has been assessed, for which all judicial and administrative remedies have been exhausted, or have lapsed, and that is not being paid in a timely manner pursuant to an agreement with the authority responsible for collecting the tax liability (USDOT Order 4200.6 implementing appropriations act requirements).

b. Where the prospective participant is unable to certify to any of the statements in this certification, such prospective participant should attach an explanation to this proposal. 2 CFR 180.335 and 180.340.

## **3. Instructions for Certification - Lower Tier Participants:**

(Applicable to all subcontracts, purchase orders, and other lower tier transactions requiring prior FHWA approval or estimated to cost \$25,000 or more - 2 CFR Parts 180 and 1200). 2 CFR 180.220 and 1200.220.

a. By signing and submitting this proposal, the prospective lower tier participant is providing the certification set out below.

b. The certification in this clause is a material representation of fact upon which reliance was placed when this transaction was entered into. If it is later determined that the prospective lower tier participant knowingly rendered an erroneous certification, in addition to other remedies available to the Federal Government, the department, or agency with which this transaction originated may pursue available remedies, including suspension and/or debarment.

c. The prospective lower tier participant shall provide immediate written notice to the person to which this proposal is submitted if at any time the prospective lower tier participant learns that its certification was erroneous by reason of changed circumstances. 2 CFR 180.365.

d. The terms "covered transaction," "debarred," "suspended," "ineligible," "participant," "person," "principal," and "voluntarily excluded," as used in this clause, are defined in 2 CFR Parts 180, Subpart I, 180.900 – 180.1020, and 1200. You may contact the person to which this proposal is

submitted for assistance in obtaining a copy of those regulations. "First Tier Covered Transactions" refers to any covered transaction between a recipient or subrecipient of Federal funds and a participant (such as the prime or general contractor). "Lower Tier Covered Transactions" refers to any covered transaction under a First Tier Covered Transaction (such as subcontracts). "First Tier Participant" refers to the participant who has entered into a covered transaction with a recipient or subrecipient of Federal funds (such as the prime or general contractor). "Lower Tier Participant" refers any participant who has entered into a covered transaction with a First Tier Participant or other Lower Tier Participants (such as subcontractors and suppliers).

e. The prospective lower tier participant agrees by submitting this proposal that, should the proposed covered transaction be entered into, it shall not knowingly enter into any lower tier covered transaction with a person who is debarred, suspended, declared ineligible, or voluntarily excluded from participation in this covered transaction, unless authorized by the department or agency with which this transaction originated. 2 CFR 1200.220 and 1200.332.

f. The prospective lower tier participant further agrees by submitting this proposal that it will include this clause titled "Certification Regarding Debarment, Suspension, Ineligibility and Voluntary Exclusion-Lower Tier Covered Transaction," without modification, in all lower tier covered transactions and in all solicitations for lower tier covered transactions exceeding the \$25,000 threshold. 2 CFR 180.220 and 1200.220.

g. A participant in a covered transaction may rely upon a certification of a prospective participant in a lower tier covered transaction that is not debarred, suspended, ineligible, or voluntarily excluded from the covered transaction, unless it knows that the certification is erroneous. A participant is responsible for ensuring that its principals are not suspended, debarred, or otherwise ineligible to participate in covered transactions. To verify the eligibility of its principals, as well as the eligibility of any lower tier prospective participants, each participant may, but is not required to, check the System for Award Management website (<https://www.sam.gov/>), which is compiled by the General Services Administration. 2 CFR 180.300, 180.320, 180.330, and 180.335.

h. Nothing contained in the foregoing shall be construed to require establishment of a system of records in order to render in good faith the certification required by this clause. The knowledge and information of participant is not required to exceed that which is normally possessed by a prudent person in the ordinary course of business dealings.

i. Except for transactions authorized under paragraph e of these instructions, if a participant in a covered transaction knowingly enters into a lower tier covered transaction with a person who is suspended, debarred, ineligible, or voluntarily excluded from participation in this transaction, in addition to other remedies available to the Federal Government, the department or agency with which this transaction originated may pursue available remedies, including suspension and/or debarment. 2 CFR 180.325.

\*\*\*\*\*

**Certification Regarding Debarment, Suspension, Ineligibility and Voluntary Exclusion--Lower Tier Participants:**

1. The prospective lower tier participant certifies, by submission of this proposal, that neither it nor its principals:

(a) is presently debarred, suspended, proposed for debarment, declared ineligible, or voluntarily excluded from participating in covered transactions by any Federal department or agency, 2 CFR 180.355;

(b) is a corporation that has been convicted of a felony violation under any Federal law within the two-year period preceding this proposal (USDOT Order 4200.6 implementing appropriations act requirements); and

(c) is a corporation with any unpaid Federal tax liability that has been assessed, for which all judicial and administrative remedies have been exhausted, or have lapsed, and that is not being paid in a timely manner pursuant to an agreement with the authority responsible for collecting the tax liability. (USDOT Order 4200.6 implementing appropriations act requirements)

2. Where the prospective lower tier participant is unable to certify to any of the statements in this certification, such prospective participant should attach an explanation to this proposal.

\*\*\*\*\*

**XI. CERTIFICATION REGARDING USE OF CONTRACT FUNDS FOR LOBBYING**

This provision is applicable to all Federal-aid construction contracts and to all related subcontracts which exceed \$100,000. 49 CFR Part 20, App. A.

1. The prospective participant certifies, by signing and submitting this bid or proposal, to the best of his or her knowledge and belief, that:

a. No Federal appropriated funds have been paid or will be paid, by or on behalf of the undersigned, to any person for influencing or attempting to influence an officer or employee of any Federal agency, a Member of Congress, an officer or employee of Congress, or an employee of a Member of Congress in connection with the awarding of any Federal contract, the making of any Federal grant, the making of any Federal loan, the entering into of any cooperative agreement, and the extension, continuation, renewal, amendment, or modification of any Federal contract, grant, loan, or cooperative agreement.

b. If any funds other than Federal appropriated funds have been paid or will be paid to any person for influencing or attempting to influence an officer or employee of any Federal agency, a Member of Congress, an officer or employee of Congress, or an employee of a Member of Congress in connection with this Federal contract, grant, loan, or cooperative agreement, the undersigned shall complete and submit Standard Form-LLL, "Disclosure Form to Report Lobbying," in accordance with its instructions.

2. This certification is a material representation of fact upon which reliance was placed when this transaction was made or entered into. Submission of this certification is a prerequisite for making or entering into this transaction imposed by 31 U.S.C. 1352. Any person who fails to file the required certification shall be subject to a civil penalty of not less than \$10,000 and not more than \$100,000 for each such failure.

3. The prospective participant also agrees by submitting its bid or proposal that the participant shall require that the language of this certification be included in all lower tier

subcontracts, which exceed \$100,000 and that all such recipients shall certify and disclose accordingly.

## **XII. USE OF UNITED STATES-FLAG VESSELS:**

This provision is applicable to all Federal-aid construction contracts, design-build contracts, subcontracts, lower-tier subcontracts, purchase orders, lease agreements, or any other covered transaction. 46 CFR Part 381.

This requirement applies to material or equipment that is acquired for a specific Federal-aid highway project. 46 CFR 381.7. It is not applicable to goods or materials that come into inventories independent of an FHWA funded-contract.

When oceanic shipments (or shipments across the Great Lakes) are necessary for materials or equipment acquired for a specific Federal-aid construction project, the bidder, proposer, contractor, subcontractor, or vendor agrees:

1. To utilize privately owned United States-flag commercial vessels to ship at least 50 percent of the gross tonnage (computed separately for dry bulk carriers, dry cargo liners, and tankers) involved, whenever shipping any equipment, material, or commodities pursuant to this contract, to the extent such vessels are available at fair and reasonable rates for United States-flag commercial vessels. 46 CFR 381.7.
2. To furnish within 20 days following the date of loading for shipments originating within the United States or within 30 working days following the date of loading for shipments originating outside the United States, a legible copy of a rated, 'on-board' commercial ocean bill-of-lading in English for each shipment of cargo described in paragraph (b)(1) of this section to both the Contracting Officer (through the prime contractor in the case of subcontractor bills-of-lading) and to the Office of Cargo and Commercial Sealift (MAR-620), Maritime Administration, Washington, DC 20590. (MARAD requires copies of the ocean carrier's (master) bills of lading, certified onboard, dated, with rates and charges. These bills of lading may contain business sensitive information and therefore may be submitted directly to MARAD by the Ocean Transportation Intermediary on behalf of the contractor). 46 CFR 381.7.



**ATTACHMENT A - EMPLOYMENT AND MATERIALS  
PREFERENCE FOR APPALACHIAN DEVELOPMENT  
HIGHWAY SYSTEM OR APPALACHIAN LOCAL ACCESS  
ROAD CONTRACTS (23 CFR 633, Subpart B, Appendix B)**

This provision is applicable to all Federal-aid projects funded under the Appalachian Regional Development Act of 1965.

1. During the performance of this contract, the contractor undertaking to do work which is, or reasonably may be, done as on-site work, shall give preference to qualified persons who regularly reside in the labor area as designated by the DOL wherein the contract work is situated, or the subregion, or the Appalachian counties of the State wherein the contract work is situated, except:

a. To the extent that qualified persons regularly residing in the area are not available.

b. For the reasonable needs of the contractor to employ supervisory or specially experienced personnel necessary to assure an efficient execution of the contract work.

c. For the obligation of the contractor to offer employment to present or former employees as the result of a lawful collective bargaining contract, provided that the number of nonresident persons employed under this subparagraph (1c) shall not exceed 20 percent of the total number of employees employed by the contractor on the contract work, except as provided in subparagraph (4) below.

2. The contractor shall place a job order with the State Employment Service indicating (a) the classifications of the laborers, mechanics and other employees required to perform the contract work, (b) the number of employees required in each classification, (c) the date on which the participant estimates such employees will be required, and (d) any other pertinent information required by the State Employment Service to complete the job order form. The job order may be placed with the State Employment Service in writing or by telephone. If during the course of the contract work, the information submitted by the contractor in the original job order is substantially modified, the participant shall promptly notify the State Employment Service.

3. The contractor shall give full consideration to all qualified job applicants referred to him by the State Employment Service. The contractor is not required to grant employment to any job applicants who, in his opinion, are not qualified to perform the classification of work required.

4. If, within one week following the placing of a job order by the contractor with the State Employment Service, the State Employment Service is unable to refer any qualified job applicants to the contractor, or less than the number requested, the State Employment Service will forward a certificate to the contractor indicating the unavailability of applicants. Such certificate shall be made a part of the contractor's permanent project records. Upon receipt of this certificate, the contractor may employ persons who do not normally reside in the labor area to fill positions covered by the certificate, notwithstanding the provisions of subparagraph (1c) above.

5. The provisions of 23 CFR 633.207(e) allow the contracting agency to provide a contractual preference for the use of mineral resource materials native to the Appalachian region.

6. The contractor shall include the provisions of Sections 1 through 4 of this Attachment A in every subcontract for work which is, or reasonably may be, done as on-site work.

APPENDIX C OF THE SUPPLEMENTARY CONDITIONS  
EXECUTIVE ORDER 11246 EQUAL EMPLOYMENT OPPORTUNITY

## **Executive Order 11246 - Equal Employment Opportunity**

SOURCE: The provisions of Executive Order 11246 of Sept. 24, 1965, appear at 30 FR 12319, 12935, 3 CFR, 1964-1965 Comp., p.339, unless otherwise noted.

Under and by virtue of the authority vested in me as President of the United States by the Constitution and statutes of the United States, it is ordered as follows:

### Part I - Nondiscrimination in Government Employment

[Part I superseded by EO 11478 of Aug. 8, 1969, 34 FR 12985, 3 CFR, 1966-1970 Comp., p. 803]

### Part II - Nondiscrimination in Employment by Government Contractors and Subcontractors

#### Subpart A - Duties of the Secretary of Labor

SEC. 201. The Secretary of Labor shall be responsible for the administration and enforcement of Parts II and III of this Order. The Secretary shall adopt such rules and regulations and issue such orders as are deemed necessary and appropriate to achieve the purposes of Parts II and III of this Order.

[Sec. 201 amended by EO 12086 of Oct. 5, 1978, 43 FR 46501, 3 CFR, 1978 Comp., p. 230]

#### Subpart B - Contractors' Agreements

SEC. 202. Except in contracts exempted in accordance with Section 204 of this Order, all Government contracting agencies shall include in every Government contract hereafter entered into the following provisions:

"During the performance of this contract, the contractor agrees as follows:

"(1) The contractor will not discriminate against any employee or applicant for employment because of race, color, religion, sex, or national origin. The contractor will take affirmative action to ensure that applicants are employed, and that employees are treated during employment, without regard to their race, color, religion, sex or national origin. Such action shall include, but not be limited to the following: employment, upgrading, demotion, or transfer; recruitment or recruitment advertising; layoff or termination; rates of pay or other forms of compensation; and selection for training, including apprenticeship. The contractor agrees to post in conspicuous places, available to employees and applicants for employment, notices to be provided by the contracting officer setting

forth the provisions of this nondiscrimination clause.

"(2) The contractor will, in all solicitations or advancements for employees placed by or on behalf of the contractor, state that all qualified applicants will receive consideration for employment without regard to race, color, religion, sex or national origin.

"(3) The contractor will send to each labor union or representative of workers with which he has a collective bargaining agreement or other contract or understanding, a notice, to be provided by the agency contracting officer, advising the labor union or workers' representative of the contractor's commitments under Section 202 of Executive Order No. 11246 of September 24, 1965, and shall post copies of the notice in conspicuous places available to employees and applicants for employment.

"(4) The contractor will comply with all provisions of Executive Order No. 11246 of Sept. 24, 1965, and of the rules, regulations, and relevant orders of the Secretary of Labor.

"(5) The contractor will furnish all information and reports required by Executive Order No. 11246 of September 24, 1965, and by the rules, regulations, and orders of the Secretary of Labor, or pursuant thereto, and will permit access to his books, records, and accounts by the contracting agency and the Secretary of Labor for purposes of investigation to ascertain compliance with such rules, regulations, and orders.

"(6) In the event of the contractor's noncompliance with the nondiscrimination clauses of this contract or with any of such rules, regulations, or orders, this contract may be cancelled, terminated, or suspended in whole or in part and the contractor may be declared ineligible for further Government contracts in accordance with procedures authorized in Executive Order No. 11246 of Sept. 24, 1965, and such other sanctions may be imposed and remedies invoked as provided in Executive Order No. 11246 of September 24, 1965, or by rule, regulation, or order of the Secretary of Labor, or as otherwise provided by law.

"(7) The contractor will include the provisions of paragraphs (1) through (7) in every subcontract or purchase order unless exempted by rules, regulations, or orders of the Secretary of Labor issued pursuant to Section 204 of Executive Order No. 11246 of September 24, 1965, so that such provisions will be binding upon each subcontractor or vendor. The contractor will take such action with respect to any subcontract or purchase order as may be directed by the Secretary of Labor as

a means of enforcing such provisions including sanctions for noncompliance: Provided, however, that in the event the contractor becomes involved in, or is threatened with, litigation with a subcontractor or vendor as a result of such direction, the contractor may request the United States to enter into such litigation to protect the interests of the United States." [Sec. 202 amended by EO 11375 of Oct. 13, 1967, 32 FR 14303, 3 CFR, 1966-1970 Comp., p. 684, EO 12086 of Oct. 5, 1978, 43 FR 46501, 3 CFR, 1978 Comp., p. 230]

SEC. 203. Each contractor having a contract containing the provisions prescribed in Section 202 shall file, and shall cause each of his subcontractors to file, Compliance Reports with the contracting agency or the Secretary of Labor as may be directed. Compliance Reports shall be filed within such times and shall contain such information as to the practices, policies, programs, and employment policies, programs, and employment statistics of the contractor and each subcontractor, and shall be in such form, as the Secretary of Labor may prescribe.

(b) Bidders or prospective contractors or subcontractors may be required to state whether they have participated in any previous contract subject to the provisions of this Order, or any preceding similar Executive order, and in that event to submit, on behalf of themselves and their proposed subcontractors, Compliance Reports prior to or as an initial part of their bid or negotiation of a contract.

(c) Whenever the contractor or subcontractor has a collective bargaining agreement or other contract or understanding with a labor union or an agency referring workers or providing or supervising apprenticeship or training for such workers, the Compliance Report shall include such information as to such labor union's or agency's practices and policies affecting compliance as the Secretary of Labor may prescribe: Provided, That to the extent such information is within the exclusive possession of a labor union or an agency referring workers or providing or supervising apprenticeship or training and such labor union or agency shall refuse to furnish such information to the contractor, the contractor shall so certify to the Secretary of Labor as part of its Compliance Report and shall set forth what efforts he has made to obtain such information.

(d) The Secretary of Labor may direct that any bidder or prospective contractor or subcontractor shall submit, as part of his Compliance Report, a statement in writing, signed by an authorized officer or agent on behalf of any labor union or any agency referring workers or providing or supervising apprenticeship or other training, with which the bidder or prospective contractor deals, with

supporting information, to the effect that the signer's practices and policies do not discriminate on the grounds of race, color, religion, sex or national origin, and that the signer either will affirmatively cooperate in the implementation of the policy and provisions of this Order or that it consents and agrees that recruitment, employment, and the terms and conditions of employment under the proposed contract shall be in accordance with the purposes and provisions of the order. In the event that the union, or the agency shall refuse to execute such a statement, the Compliance Report shall so certify and set forth what efforts have been made to secure such a statement and such additional factual material as the Secretary of Labor may require.

[Sec. 203 amended by EO 11375 of Oct. 13, 1967, 32 FR 14303, 3 CFR, 1966-1970 Comp., p. 684; EO 12086 of Oct. 5, 1978, 43 FR 46501, 3 CFR, 1978 Comp., p. 230]

SEC. 204. The Secretary of Labor may, when he/she deems that special circumstances in the national interest so require, exempt a contracting agency from the requirement of including any or all of the provisions of Section 202 of this Order in any specific contract, subcontract, or purchase order. The Secretary of Labor may, by rule or regulation, also exempt certain classes of contracts, subcontracts, or purchase orders (1) whenever work is to be or has been performed outside the United States and no recruitment of workers within the limits of the United States is involved; (2) for standard commercial supplies or raw materials; (3) involving less than specified amounts of money or specified numbers of workers; or (4) to the extent that they involve subcontracts below a specified tier. The Secretary of Labor may also provide, by rule, regulation, or order, for the exemption of facilities of a contractor which are in all respects separate and distinct from activities of the contractor related to the performance of the contract: Provided, That such an exemption will not interfere with or impede the effectuation of the purposes of this Order: And provided further, That in the absence of such an exemption, all facilities shall be covered by the provisions of this Order.

#### Subpart C - Powers and Duties of the Secretary of Labor and the Contracting Agencies

SEC. 205. The Secretary of Labor shall be responsible for securing compliance by all Government contractors and subcontractors with this Order and any implementing rules or regulations. All contracting agencies shall comply with the terms of this Order and any implementing rules, regulations, or orders of the Secretary of Labor. Contracting agencies shall cooperate with the Secretary of Labor and shall furnish such information and assistance as the Secretary may require.

[Sec. 205 amended by EO 12086 of Oct. 5, 1978, 43 FR 46501, 3 CFR, 1978 Comp., p. 230]

SEC. 206. The Secretary of Labor may investigate the employment practices of any Government contractor or subcontractor to determine whether or not the contractual provisions specified in Section 202 of this Order have been violated. Such investigation shall be conducted in accordance with the procedures established by the Secretary of Labor.

(b) The Secretary of Labor may receive and investigate complaints by employees or prospective employees of a Government contractor or subcontractor which allege discrimination contrary to the contractual provisions specified in Section 202 of this Order.

[Sec. 206 amended by EO 12086 of Oct. 5, 1978, 43 FR 46501, 3 CFR, 1978 Comp., p. 230]

SEC. 207. The Secretary of Labor shall use his/her best efforts, directly and through interested Federal, State, and local agencies, contractors, and all other available instrumentalities to cause any labor union engaged in work under Government contracts or any agency referring workers or providing or supervising apprenticeship or training for or in the course of such work to cooperate in the implementation of the purposes of this Order. The Secretary of Labor shall, in appropriate cases, notify the Equal Employment Opportunity Commission, the Department of Justice, or other appropriate Federal agencies whenever it has reason to believe that the practices of any such labor organization or agency violate Title VI or Title VII of the Civil Rights Act of 1964 or other provision of Federal law.

[Sec. 207 amended by EO 12086 of Oct. 5, 1978, 43 FR 46501, 3 CFR, 1978 Comp., p. 230]

SEC. 208. The Secretary of Labor, or any agency, officer, or employee in the executive branch of the Government designated by rule, regulation, or order of the Secretary, may hold such hearings, public or private, as the Secretary may deem advisable for compliance, enforcement, or educational purposes.

(b) The Secretary of Labor may hold, or cause to be held, hearings in accordance with Subsection of this Section prior to imposing, ordering, or recommending the imposition of penalties and sanctions under this Order. No order for debarment of any contractor from further Government

contracts under Section 209(6) shall be made without affording the contractor an opportunity for a hearing.

#### Subpart D - Sanctions and Penalties

SEC. 209. In accordance with such rules, regulations, or orders as the Secretary of Labor may issue or adopt, the Secretary may:

(1) Publish, or cause to be published, the names of contractors or unions which it has concluded have complied or have failed to comply with the provisions of this Order or of the rules, regulations, and orders of the Secretary of Labor.

(2) Recommend to the Department of Justice that, in cases in which there is substantial or material violation or the threat of substantial or material violation of the contractual provisions set forth in Section 202 of this Order, appropriate proceedings be brought to enforce those provisions, including the enjoining, within the limitations of applicable law, of organizations, individuals, or groups who prevent directly or indirectly, or seek to prevent directly or indirectly, compliance with the provisions of this Order.

(3) Recommend to the Equal Employment Opportunity Commission or the Department of Justice that appropriate proceedings be instituted under Title VII of the Civil Rights Act of 1964.

(4) Recommend to the Department of Justice that criminal proceedings be brought for the furnishing of false information to any contracting agency or to the Secretary of Labor as the case may be.

(5) After consulting with the contracting agency, direct the contracting agency to cancel, terminate, suspend, or cause to be cancelled, terminated, or suspended, any contract, or any portion or portions thereof, for failure of the contractor or subcontractor to comply with equal employment opportunity provisions of the contract. Contracts may be cancelled, terminated, or suspended absolutely or continuance of contracts may be conditioned upon a program for future compliance approved by the Secretary of Labor.

(6) Provide that any contracting agency shall refrain from entering into further contracts, or extensions or other modifications of existing contracts, with any noncomplying contractor, until such contractor has satisfied the Secretary of Labor that such contractor has established and will carry out



personnel and employment policies in compliance with the provisions of this Order.

(b) Pursuant to rules and regulations prescribed by the Secretary of Labor, the Secretary shall make reasonable efforts, within a reasonable time limitation, to secure compliance with the contract provisions of this Order by methods of conference, conciliation, mediation, and persuasion before proceedings shall be instituted under subsection (a)(2) of this Section, or before a contract shall be cancelled or terminated in whole or in part under subsection (a)(5) of this Section.

[Sec. 209 amended by EO 12086 of Oct. 5, 1978, 43 FR 46501, 3 CFR, 1978 Comp., p. 230]

SEC. 210. Whenever the Secretary of Labor makes a determination under Section 209, the Secretary shall promptly notify the appropriate agency. The agency shall take the action directed by the Secretary and shall report the results of the action it has taken to the Secretary of Labor within such time as the Secretary shall specify. If the contracting agency fails to take the action directed within thirty days, the Secretary may take the action directly.

[Sec. 210 amended by EO 12086 of Oct. 5, 1978, 43 FR 46501, 3 CFR, 1978 Comp., p. 230]

SEC. 211. If the Secretary shall so direct, contracting agencies shall not enter into contracts with any bidder or prospective contractor unless the bidder or prospective contractor has satisfactorily complied with the provisions of this Order or submits a program for compliance acceptable to the Secretary of Labor.

[Sec. 211 amended by EO 12086 of Oct. 5, 1978, 43 FR 46501, 3 CFR, 1978 Comp., p. 230]

SEC. 212. When a contract has been cancelled or terminated under Section 209(a)(5) or a contractor has been debarred from further Government contracts under Section 209(a)(6) of this Order, because of noncompliance with the contract provisions specified in Section 202 of this Order, the Secretary of Labor shall promptly notify the Comptroller General of the United States.

[Sec. 212 amended by EO 12086 of Oct. 5, 1978, 43 FR 46501, 3 CFR, 1978 Comp., p. 230]

#### Subpart E - Certificates of Merit

SEC. 213. The Secretary of Labor may provide for issuance of a United States Government Certificate of Merit to employers or labor unions, or other agencies which are or may hereafter be engaged in work under Government contracts, if the Secretary is satisfied that the personnel and

employment practices of the employer, or that the personnel, training, apprenticeship, membership, grievance and representation, upgrading, and other practices and policies of the labor union or other agency conform to the purposes and provisions of this Order.

SEC. 214. Any Certificate of Merit may at any time be suspended or revoked by the Secretary of Labor if the holder thereof, in the judgment of the Secretary, has failed to comply with the provisions of this Order.

SEC. 215. The Secretary of Labor may provide for the exemption of any employer, labor union, or other agency from any reporting requirements imposed under or pursuant to this Order if such employer, labor union, or other agency has been awarded a Certificate of Merit which has not been suspended or revoked.

### Part III - Nondiscrimination Provisions in Federally Assisted Construction Contracts

SEC. 301. Each executive department and agency, which administers a program involving Federal financial assistance shall require as a condition for the approval of any grant, contract, loan, insurance, or guarantee thereunder, which may involve a construction contract, that the applicant for Federal assistance undertake and agree to incorporate, or cause to be

incorporated, into all construction contracts paid for in whole or in part with funds obtained from the Federal Government or borrowed on the credit of the Federal Government pursuant to such grant,

contract, loan, insurance, or guarantee, or undertaken pursuant to any Federal program involving such grant, contract, loan, insurance, or guarantee, the provisions prescribed for Government contracts by Section 202 of this Order or such modification thereof, preserving in substance the contractor's obligations thereunder, as may be approved by the Secretary of Labor, together with such additional provisions as the Secretary deems appropriate to establish and protect the interest of

the United States in the enforcement of those obligations. Each such applicant shall also undertake

and agree (1) to assist and cooperate actively with the Secretary of Labor in obtaining the compliance of contractors and subcontractors with those contract provisions and with the rules, regulations and relevant orders of the Secretary, (2) to obtain and to furnish to the Secretary of Labor such information as the Secretary may require for the supervision of such compliance, (3) to

carry out sanctions and penalties for violation of such obligations imposed upon contractors and subcontractors by the Secretary of Labor pursuant to Part II, Subpart D, of this Order, and (4) to

refrain from entering into any contract subject to this Order, or extension or other modification of such a contract with a contractor debarred from Government contracts under Part II, Subpart D, of this Order.

[Sec. 301 amended by EO 12086 of Oct. 5, 1978, 43 FR 46501, 3 CFR, 1978 Comp., p. 230]

SEC. 302. "Construction contract" as used in this Order means any contract for the construction, rehabilitation, alteration, conversion, extension, or repair of buildings, highways, or other improvements to real property.

(b) The provisions of Part II of this Order shall apply to such construction contracts, and for purposes of such application the administering department or agency shall be considered the contracting agency referred to therein.

(c) The term "applicant" as used in this Order means an applicant for Federal assistance or, as determined by agency regulation, other program participant, with respect to whom an application for any grant, contract, loan, insurance, or guarantee is not finally acted upon prior to the effective date of this Part, and it includes such an applicant after he/she becomes a recipient of such Federal assistance.

SEC. 303. The Secretary of Labor shall be responsible for obtaining the compliance of such applicants with their undertakings under this Order. Each administering department and agency is directed to cooperate with the Secretary of Labor and to furnish the Secretary such information and assistance as the Secretary may require in the performance of the Secretary's functions under this Order.

(b) In the event an applicant fails and refuses to comply with the applicant's undertakings pursuant to this Order, the Secretary of Labor may, after consulting with the administering department or agency, take any or all of the following actions: (1) direct any administering department or agency to cancel, terminate, or suspend in whole or in part the agreement, contract or other arrangement with such applicant with respect to which the failure or refusal occurred; (2) direct any administering department or agency to refrain from extending any further assistance to the applicant under the program with respect to which the failure or refusal occurred until satisfactory assurance of future compliance has been received by the Secretary of Labor from such applicant; and (3) refer the case to the Department of Justice or the Equal Employment Opportunity Commission for appropriate law

enforcement or other proceedings.

(c) In no case shall action be taken with respect to an applicant pursuant to clause (1) or (2) of subsection (b) without notice and opportunity for hearing.

[Sec. 303 amended by EO 12086 of Oct. 5, 1978, 43 FR 46501, 3 CFR, 1978 Comp., p. 230]

SEC. 304. Any executive department or agency which imposes by rule, regulation, or order requirements of nondiscrimination in employment, other than requirements imposed pursuant to this

Order, may delegate to the Secretary of Labor by agreement such responsibilities with respect to compliance standards, reports, and procedures as would tend to bring the administration of such requirements into conformity with the administration of requirements imposed under this Order: Provided, That actions to effect compliance by recipients of Federal financial assistance with requirements imposed pursuant to Title VI of the Civil Rights Act of 1964 shall be taken in conformity with the procedures and limitations prescribed in Section 602 thereof and the regulations

of the administering department or agency issued thereunder.

#### Part IV - Miscellaneous

SEC. 401. The Secretary of Labor may delegate to any officer, agency, or employee in the Executive branch of the Government, any function or duty of the Secretary under Parts II and III of this Order.

[Sec. 401 amended by EO 12086 of Oct. 5, 1978, 43 FR 46501, 3 CFR, 1978 Comp., p. 230]

SEC. 402. The Secretary of Labor shall provide administrative support for the execution of the program known as the "Plans for Progress."

SEC. 403. Executive Orders Nos. 10590 (January 19, 1955), 10722 (August 5, 1957), 10925 (March 6, 1961), 11114 (June 22, 1963), and 11162 (July 28, 1964), are hereby superseded and the President's Committee on Equal Employment Opportunity established by Executive Order No.

10925 is hereby abolished. All records and property in the custody of the Committee shall be transferred to the Office of Personnel Management and the Secretary of Labor, as appropriate.

(b) Nothing in this Order shall be deemed to relieve any person of any obligation assumed or imposed under or pursuant to any Executive Order superseded by this Order. All rules, regulations,

orders, instructions, designations, and other directives issued by the President's Committee on Equal

Employment Opportunity and those issued by the heads of various departments or agencies under or

pursuant to any of the Executive orders superseded by this Order, shall, to the extent that they are

not inconsistent with this Order, remain in full force and effect unless and until revoked or superseded by appropriate authority. References in such directives to provisions of the superseded orders shall be deemed to be references to the comparable provisions of this Order.

[Sec. 403 amended by EO 12107 of Dec. 28, 1978, 44 FR 1055, 3 CFR, 1978 Comp., p, 264]

SEC. 404. The General Services Administration shall take appropriate action to revise the standard Government contract forms to accord with the provisions of this Order and of the rules and regulations of the Secretary of Labor.

SEC. 405. This Order shall become effective thirty days after the date of this Order.

APPENDIX D OF THE SUPPLEMENTARY CONDITIONS  
SMALL BUSINESS DIVISION, PROJECT WORKSHEET  
DOES NOT APPLY

APPENDIX E OF THE SUPPLEMENTARY CONDITIONS  
DEPARTMENT OF LABOR, OCCUPATIONAL SAFETY AND  
HEALTH ADMINISTRATION FORMS (300, 300A AND 301)





# Summary of Work-Related Injuries and Illnesses

Year 20 \_\_\_\_\_



Form approved OMB no. 1218-0176

All establishments covered by Part 1904 must complete this Summary page, even if no work-related injuries or illnesses occurred during the year. Remember to review the Log to verify that the entries are complete and accurate before completing this summary.

Using the Log, count the individual entries you made for each category. Then write the totals below, making sure you've added the entries from every page of the Log. If you had no cases, write "0."

Employees, former employees, and their representatives have the right to review the OSHA Form 300 in its entirety. They also have limited access to the OSHA Form 301 or its equivalent. See 29 CFR Part 1904.35, in OSHA's recordkeeping rule, for further details on the access provisions for these forms.

### Number of Cases

Total number of deaths	Total number of cases with days away from work	Total number of cases with job transfer or restriction	Total number of other recordable cases
(G) _____	(H) _____	(I) _____	(J) _____

### Number of Days

Total number of days away from work	Total number of days of job transfer or restriction
(K) _____	(L) _____

### Injury and Illness Types

Total number of . . .	(1) Injuries	(4) Poisonings
(M) _____	_____	_____
(2) Skin disorders	(5) Hearing loss	(6) All other illnesses
_____	_____	_____
(3) Respiratory conditions	_____	_____
_____	_____	_____

**Post this Summary page from February 1 to April 30 of the year following the year covered by the form.**

Public reporting burden for this collection of information is estimated to average 58 minutes per response, including time to review the instructions, search and gather the data needed, and complete and review the collection of information. Persons are not required to respond to the collection of information unless it displays a currently valid OMB control number. If you have any comments about these estimates or any other aspects of this data collection, contact: US Department of Labor, OSHA Office of Statistical Analysis, Room N-3644, 200 Constitution Avenue, NW, Washington, DC 20210. Do not send the completed forms to this office.

### Establishment information

Your establishment name \_\_\_\_\_  
 Street \_\_\_\_\_  
 City \_\_\_\_\_ State \_\_\_\_\_ ZIP \_\_\_\_\_  
 Industry description (e.g., *Manufacture of motor truck trailers*) \_\_\_\_\_  
 Standard Industrial Classification (SIC), if known (e.g., 3715) \_\_\_\_\_  
 OR \_\_\_\_\_  
 North American Industrial Classification (NAICS), if known (e.g., 336212) \_\_\_\_\_

### Employment information (If you don't have these figures, see the Worksheet on the back of this page to estimate.)

Annual average number of employees \_\_\_\_\_  
 Total hours worked by all employees last year \_\_\_\_\_

### Sign here

**Knowingly falsifying this document may result in a fine.**

I certify that I have examined this document and that to the best of my knowledge the entries are true, accurate, and complete.

Company executive \_\_\_\_\_ Title \_\_\_\_\_  
 ( \_\_\_\_\_ ) \_\_\_\_\_ / /  
 Phone \_\_\_\_\_ Date \_\_\_\_\_

# OSHA's Form 301 Injury and Illness Incident Report

**Attention:** This form contains information relating to employee health and must be used in a manner that protects the confidentiality of employees to the extent possible while the information is being used for occupational safety and health purposes.



**U.S. Department of Labor**  
Occupational Safety and Health Administration

Form approved OMB no. 1218-0176

This *Injury and Illness Incident Report* is one of the first forms you must fill out when a recordable work-related injury or illness has occurred. Together with the *Log of Work-Related Injuries and Illnesses* and the accompanying *Summary*, these forms help the employer and OSHA develop a picture of the extent and severity of work-related incidents.

Within 7 calendar days after you receive information that a recordable work-related injury or illness has occurred, you must fill out this form or an equivalent. Some state workers' compensation, insurance, or other reports may be acceptable substitutes. To be considered an equivalent form, any substitute must contain all the information asked for on this form.

According to Public Law 91-596 and 29 CFR 1904, OSHA's recordkeeping rule, you must keep this form on file for 5 years following the year to which it pertains.

If you need additional copies of this form, you may photocopy and use as many as you need.

## Information about the employee

- 1) Full name \_\_\_\_\_
- 2) Street \_\_\_\_\_  
City \_\_\_\_\_ State \_\_\_\_\_ ZIP \_\_\_\_\_
- 3) Date of birth \_\_\_\_/\_\_\_\_/\_\_\_\_
- 4) Date hired \_\_\_\_/\_\_\_\_/\_\_\_\_
- 5)  Male  
 Female

## Information about the physician or other health care professional

- 6) Name of physician or other health care professional \_\_\_\_\_  
Facility \_\_\_\_\_  
Street \_\_\_\_\_  
City \_\_\_\_\_ State \_\_\_\_\_ ZIP \_\_\_\_\_
- 7) If treatment was given away from the worksite, where was it given?  
 Yes  
 No
- 8) Was employee hospitalized overnight as an in-patient?  
 Yes  
 No

## Information about the case

- 10) Case number from the Log \_\_\_\_\_ (Transfer the case number from the Log after you record the case.)
- 11) Date of injury or illness \_\_\_\_/\_\_\_\_/\_\_\_\_ AM / PM
- 12) Time employee began work \_\_\_\_\_ AM / PM
- 13) Time of event \_\_\_\_\_ AM / PM  Check if time cannot be determined
- 14) **What was the employee doing just before the incident occurred?** Describe the activity, as well as the tools, equipment, or material the employee was using. Be specific. *Examples:* "climbing a ladder while carrying roofing materials"; "spraying chlorine from hand sprayer"; "daily computer key-entry."
- 15) **What happened?** Tell us how the injury occurred. *Examples:* "When ladder slipped on wet floor, worker fell 20 feet"; "Worker was sprayed with chlorine when gasket broke during replacement"; "Worker developed soreness in wrist over time."
- 16) **What was the injury or illness?** Tell us the part of the body that was affected and how it was affected; be more specific than "hurt," "pain," or "sore." *Examples:* "strained back"; "chemical burn, hand"; "carpal tunnel syndrome."
- 17) **What object or substance directly harmed the employee?** *Examples:* "concrete floor"; "chlorine"; "radial arm saw." If this question does not apply to the incident, leave it blank.
- 18) **If the employee died, when did death occur?** Date of death \_\_\_\_/\_\_\_\_/\_\_\_\_

Completed by \_\_\_\_\_ Title \_\_\_\_\_  
 Phone (\_\_\_\_) \_\_\_\_\_ Date \_\_\_\_/\_\_\_\_/\_\_\_\_

## **SECTION 6: SPECIFICATIONS**

DTPW DIVISION 1 SPECIFICATIONS  
(GENERAL REQUIREMENTS)

DTPW SPECIFICATIONS  
GENERAL REQUIREMENTS  
TABLE OF CONTENTS

**1. GENERAL REQUIREMENTS**

---

1.01	DEFINITIONS AND TERMINOLOGY.....	1
A.	General .....	1
B.	Governing Regulations and Standard References .....	1
C.	Abbreviations .....	2
D.	Definitions .....	3
1.02	WORK COVERED BY THE CONTRACT DOCUMENTS.....	6
A.	Intent of Contract and Contract Documents .....	6
B.	Alteration of Plans or of Character of Work .....	6
C.	Connections to Existing Pavement, Drives and Walks .....	6
D.	Differing Site Conditions.....	7
E.	Underground Facilities. ....	7
F.	Contractor Proposed Changes Affecting Utilities .....	8
G.	Rights in and Use of Materials Found on the Site of the Work .....	8
H.	Restoration of Property .....	8
I.	Final Cleaning Up of Right-of-Way.....	9
1.03	CONTROLLING WORK .....	9
A.	Plans .....	9
B.	Typical Details and/or Sketches .....	9
C.	Or-Equals and Substitutes .....	10
D.	Right Of Way Verification .....	11
E.	Shop Drawings.....	11
F.	Coordination of Contract Documents .....	15
G.	Conformity of Work with Contract Documents.....	15
H.	Errors or Omissions in Contract Documents .....	15
I.	Authority of Engineer.....	15
J.	Authority and Duties of Engineer's Assistants.....	15
K.	Engineering and Layout .....	15
L.	Contractor's Supervision .....	17
M.	General Inspection Requirements.....	17
N.	Final Inspection .....	17
O.	Final Acceptance.....	18
1.04	CONTROLLING MATERIALS .....	18
A.	Acceptance Criteria .....	18
B.	Applicable Documented Authorities Other Than Specifications .....	19
C.	Storage of Materials and Samples .....	19
D.	Defective Materials.....	19
E.	Products and Source of Supply .....	19
1.05	LEGAL REQUIREMENTS AND RESPONSIBILITY TO THE PUBLIC.....	20
A.	Disaster Preparedness.....	20
B.	Laws to be Observed .....	21
C.	Permits and Licenses.....	24

D.	Patented Devices, Materials and Processes.....	25
E.	Right-of-Way Furnished by the Department.....	25
F.	Sanitary Provisions.....	25
G.	Control of Contractor's Equipment.....	25
H.	Contractor's Equipment on Bridge Structures.....	25
I.	Structures over Navigable Waters.....	26
J.	Manatee Protection.....	26
K.	Forest Protection.....	27
L.	Preservation of Property.....	27
M.	Responsibility for Damages, Claims, etc.....	30
N.	Contractor's Responsibility for Work.....	30
O.	Opening Sections of Roadway to Traffic.....	30
P.	Scales for Weighing Materials.....	30
Q.	Source of Forest Products.....	30
R.	Dust Control.....	30
S.	Dredging and Filling.....	31
T.	Contractor's Motor Vehicle Registration.....	31
U.	Compliance with FHWA 1273:.....	31
1.06	PROSECUTION AND PROGRESS.....	31
A.	Subletting Or Assigning The Contract.....	31
B.	Notice to Proceed.....	32
C.	Project Signs.....	32
D.	Schedule Of Values.....	32
E.	Preconstruction Conference.....	32
F.	Scheduling of the Work.....	33
G.	Progress of the Work.....	35
H.	Performance of Work.....	36
I.	As-Built Drawings.....	36
J.	Liquidated Damages.....	36
K.	Limitations of Operations.....	37
L.	Qualifications of Contractor's Personnel.....	39
M.	Temporary Suspension of Contractor's Operations.....	39
N.	Computation of Contract Time.....	40
O.	Default and Termination of Contract.....	41
P.	Release of Contractor's Responsibility.....	43
1.07	MEASUREMENT AND PAYMENT.....	43
A.	Compensation.....	43
B.	Contingency Allowance Account.....	43
C.	Florida Power And Light Connection Allowance.....	43
D.	Retainage; Punch List Requirements.....	43
E.	Measurement of Quantities.....	44
F.	Fuel Adjustment.....	44
G.	Bituminous Material.....	45
H.	Material Adjustments for Aluminum, PVC, and Copper.....	45
I.	Material Adjustments for Steel Guardrail.....	46
J.	Lump Sum Quantities.....	47
K.	Deleted Work.....	47
L.	Partial Payments.....	47
M.	Record of Construction Materials.....	48
N.	Recovery Rights, Subsequent to Final Payment.....	48

## 1. GENERAL REQUIREMENTS

---

### 1.01 DEFINITIONS AND TERMINOLOGY

#### A. General

1. These Specifications are written to the bidders, prior to award of the Contract, and to Contractor.
2. Where sentences directing work or other action appear in the active voice-imperative mood, without a subject, the subject "bidder" or "Contractor" is understood. In any other case where the subject is not clearly understood, Engineer will make a clarification and final determination as to the subject of the action.

#### B. Governing Regulations and Standard References

1. The following Standards and Governing Regulations, as amended by the Contract Documents, are hereby incorporated by reference:
  - a. Building Code as set forth in Chapter 8 of the Code of Miami-Dade County.
  - b. Public Works Manual of Metropolitan Dade County (Public Works Manual).
  - c. United States Department of Justice's 2010 ADA Standards For Accessible Design
  - d. Miami-Dade County's Traffic Control Equipment Specifications and Standards for The Metro Traffic Control System Miami-Dade County (TCESS).
  - e. Florida Department of Transportation's Standard Plans for Road and Bridge Construction (FDOT Standard Plans).  
<http://www.fdot.gov/design/standardplans/SPRBC.shtm>
  - f. Florida Department of Transportation Standard Specifications for Road and Bridge Construction (Divisions II & III), Special Provisions and Supplemental Specifications  
<http://www.fdot.gov/programmanagement/Implemented/SpecBooks/default.shtm>
  - g. Florida Department of Transportation Surveying and Mapping Procedure  
<http://fdotwp1.dot.state.fl.us/ProceduresInformationManagementSystemInternet/FormsAndProcedures/ViewDocument?topicNum=550-030-101>
  - h. Florida Department of Transportation Drainage Manual  
<http://www.fdot.gov/roadway/Drainage/Manualsandhandbooks.shtm>
  - i. Florida Department of Transportation Soils and Foundations Handbook  
<http://www.fdot.gov/structures/DocsandPubs.shtm>
  - j. Florida Department of Transportation Structures Manual

<http://www.fdot.gov/structures/DocsandPubs.shtm>

- k. Florida Department of Transportation Current Structures Design Bulletins

<http://www.fdot.gov/structures/Memos/currentbulletins.shtm>

- l. Manual on Uniform Traffic Control Devices (MUTCD)

<https://mutcd.fhwa.dot.gov/>

- m. Safe Mobility For Life Program Policy Statement

<http://www.fdot.gov/traffic/TrafficServices/SafetyisGolden.shtm>

- n. Florida Department of Transportation American with Disabilities Act (ADA) Compliance

<http://www.fdot.gov/roadway/ada/>

- o. Florida Department of Transportation Florida Sampling and Testing Methods

<http://www.fdot.gov/materials/administration/resources/library/publications/fstm/disclaimer.shtm>

- p. Florida Department of Transportation Flexible Pavement Coring and Evaluation Procedure

<http://www.fdot.gov/materials/administration/resources/library/publications/materialsmanual/documents/v1-section32-clean.pdf>

- q. Florida Department of Transportation Design Bulletins and Update Memos

<http://www.fdot.gov/roadway/Bulletin/>

- r. Florida Department of Transportation Utility Accommodation Manual

<http://www.fdot.gov/programmanagement/utilities/default.shtm>

- s. Florida Department of Transportation Flexible Pavement Design Manual

<http://www.fdot.gov/roadway/pm/pcs/flexiblepavementmanual.pdf>

- t. Florida Department of Transportation Rigid Pavement Design Manual

<http://www.fdot.gov/roadway/pm/pcs/rigidpavementmanual.pdf>

- u. Florida Department of Transportation Pavement Type Selection Manual

<http://www.fdot.gov/roadway/pm/Publications/PTSM.pdf>

- v. Florida Department of Transportation Traffic Engineering Manual

<http://www.fdot.gov/traffic/trafficservices/Studies/TEM/TEM.shtm>

- w. Florida Department of Transportation Bicycle and Pedestrian Policies and Standards

<http://www.fdot.gov/roadway/bikeped/default.shtm>

- x. Federal Highway Administration Hydraulic Engineering Circular Number 18 (HEC 18).

[https://www.fhwa.dot.gov/engineering/hydraulics/library\\_listing.cfm](https://www.fhwa.dot.gov/engineering/hydraulics/library_listing.cfm)

y. Florida Department of Transportation Manual of Uniform Minimum Standards for Design, Construction and Maintenance for Streets and Highways (Florida Greenbook)

[http://www.fdot.gov/roadway/floridagreenbook/fg\\_b.shtml](http://www.fdot.gov/roadway/floridagreenbook/fg_b.shtml)

z. Florida Department of Transportation Project Development and Environment Manual, Parts 1 and 2  
<http://www.fdot.gov/environment/pubs/pdeman/pdeman1.shtml>

aa. Florida Department of Transportation Contract Compliance Manual.  
<https://www.fdot.gov/equalopportunity/contractcompliancemanual.shtml>

bb. Florida Department of Transportation Equal Opportunity Compliance (EOC) System.  
<https://www.fdot.gov/equalopportunity/eoc.shtml>

cc. Florida Statutes  
<http://www.leg.state.fl.us/statutes/>

dd. Miami-Dade County and Local Municipal Ordinances, unless otherwise is prohibited, by State or Federal regulations.

2. The above list is not all inclusive and it is the responsibility of Contractor to comply with all applicable requirements whether included in this list or not. Additional project-specific criteria are provided throughout the Contract Documents

3. The above referenced Standards are intended to supplement, not supersede the requirements set forth herein and, unless otherwise noted, the latest revision shall apply. Where differences occur between referenced Standards and these Contract Documents, the more stringent shall apply unless otherwise noted in the Contract Documents or directed by Engineer in writing.

4. FDOT Standard Specifications.

a. FDOT Standard Specifications for Road and Bridge Construction (Divisions II & III), as amended by the Contract Documents, apply to an Article within these Specifications when:

1) The applicable FDOT Standard Specification Section (e.g. FDOT SECTION 415) is referenced in the title of the Article; or

2) The FDOT Standard Specification section, article, or subarticle is referenced within the Article (e.g. FDOT Section 415, FDOT 415-3; FDOT 415-5.1, etc.)

b. Unless otherwise specified, where page numbers are used in these Specifications to reference modifications to the FDOT Standard Specifications, it shall be understood to reference the 2007 edition.

#### C. Abbreviations

The following abbreviations, when used in the Contract Documents, represent the full text shown.

AAN	American Association of Nurserymen, Inc.
AASHTO	American Association of State Highway and Transportation Officials
ACI	American Concrete Institute
AGC	The Associated General Contractors of America, Inc.
AGMA	American Gear Manufacturers Association
AIA	American Institute of Architects.
AISI	American Iron and Steel Institute
ANSI	American National Standards Institute, Inc.
APL	FDOT Approved Product List
AREA	American Railway Engineering Association
ASCE	American Society of Civil Engineers
ASME	American Society of Mechanical Engineers
ASTM	American Society for Testing and Materials
ATSSA	American Traffic Safety Services Association
AWG	American Wire Gauge
AWPA	American Wood Preservers Association
AWS	American Welding Society
AWWA	American Water Works Association
CFR	Code of Federal Regulations
CRSI	Concrete Reinforcing Steel Institute
DOL	U.S. Department of Labor
EASA	Electrical Apparatus Service Association
EPA	Environmental Protection Agency of the United States Government
F.A.C.	Florida Administrative Code
FBC	Florida Building Code
FDEP	Florida Department of Environmental Protection
FDOH	Florida Department of Health
FDOT	Florida Department of Transportation
FHWA	Federal Highway Administration
FM	Florida Method or Florida Sampling and Testing Method
F.S.	Florida Statutes
FSS	Federal Specifications and Standards
IEEE	Institute of Electrical and Electronics Engineers
IES	Illuminating Engineering Society
IMSA	International Municipal Signal Association
IPCEA	Insulated Power Cable Engineers Association
ISO	International Organization for Standards
MDC	Miami-Dade County
MSTCSD	Minimum Specifications for Traffic Control Signals and Devices
NAM	Negotiated Acceptance Memorandum
MUTCD	Manual on Uniform Traffic Control Devices
NEC	National Electrical Code
NEMA	National Electrical Manufacturers Association
NESC	National Electrical Safety Code
NFPA	National Fire Protection Association
NIST	National Institute for Standards and Technology
NOAA	National Oceanic and Atmospheric Administration
NSF	NSF International
OSHA	Occupational Safety and Health Administration



PCA	Portland Cement Association
DTPW	Miami-Dade County Department of Transportation and Public Works
SAE	Society of Automotive Engineers
SBE-CONST	Small Business Enterprise-Construction
SI	International System of Units
SSPC	Society of Protective Coatings
TSSQPL	Traffic Signals and Signs Qualified Products List
UL	Underwriters' Laboratories
U.S.C.	United States Code

D. Definitions

The following terms, when used in the Specifications, have the meaning described.

1. Article. The numbered prime subdivision of a Division of these Specifications.
2. Bracing. A temporary structural member(s) placed between beams, girders, piles columns, etc. to provide stability during construction activities.
3. Bridge. A structure, including supports, erected over a depression or over an obstruction such as water, highway or railway, or for elevated roadway, for carrying traffic or other moving loads, and having a length, measured along the center of the roadway, of more than 20 feet between the inside faces of end supports. A multiple-span box culvert is considered a bridge, where the length between the extreme ends of the openings exceeds 20 feet.
4. Calendar day. Every day shown on the calendar, ending and beginning at midnight. Unless otherwise stipulated in the Contract Documents, the term "days" shall be understood as calendar days. In computing any period of time prescribed or allowed by this Contract, the day of the act, event, or default from which the designated period of time begins to run shall not be included. The last day of the period so computed shall be included unless it is a Saturday, Sunday, or legal holiday, in which event the period shall run until the end of the next day which is neither a Saturday, Sunday, or legal holiday. When the period of time prescribed or allowed is less than 7 days, intermediate Saturdays, Sundays, and legal holidays shall be excluded in the computation.
5. Construction Affecting Public Safety. Construction that may jeopardize public safety such as structures spanning functioning vehicular roadways, pedestrian walkways, railroads, navigation channels of navigable waterways and walls or other structure foundations located in embankments immediately adjacent to functioning roadways. It does not apply to those areas of the site under Contractor's control and outside the limits of normal public access.
6. Contract. The term "Contract" means the entire and integrated agreement between the parties thereunder and supersedes all prior negotiations, representations, or agreements, either written or oral. The executed Contract Documents form the Contract between the Department (on behalf of the County) and Contractor setting forth the obligations of the parties thereunder,

including, but not limited to, the performance of the Work and the basis of payment.

7. Contract Documents. Consists of those items so designated in and inclusive of the executed Contract. Only printed or hard copies of the items listed in the executed Contract Form are Contract Documents.
8. Contract Time. The maximum number of calendar days, including authorized time extensions, allowed for final completion of all Contract work and requirements. Also called Contract Duration.
9. Contract Unit Price. Refers to the Unit Price provided by the Contract that is fixed at time of Contract award.
10. Contractor. The individual, firm, joint venture, or company contracting with the County to perform the Work pursuant to the Contract.
11. Contractor's Engineer of Record.
  - a. A Professional Engineer registered in the State of Florida, other than the Engineer of Record or his subcontracted consultant, who undertakes the design and drawing of components of the permanent structure as part of a redesign, or for repair designs and details of the permanent work. Contractor's Engineer of Record may also serve as the Specialty Engineer.
  - b. Contractor's Engineer of Record must be an employee of a pre-qualified firm. The firm shall be pre-qualified in accordance with the Rule 14-75, F.A.C. Any Corporation or Partnership offering engineering services must hold a Certificate of Authorization from the Florida Board of Professional Engineers.
  - c. As an alternate to being an employee of a pre-qualified firm, Contractor's Engineer of Record may be a pre-qualified Specialty Engineer. For items of the permanent Work declared by the FDOT Construction Office to be "major" or "structural", the work performed by a pre-qualified Specialty Engineer must be checked by another pre-qualified Specialty Engineer. An individual Engineer may become pre-qualified in the work groups listed in Rule 14-75, F.A.C., if the requirements for the Professional Engineer are met for the individual work groups. Pre-qualified Specialty Engineers are listed on the FDOT Construction Office website. Pre-qualified Specialty Engineers will not be authorized to perform redesigns of items fully detailed in the Plans.
12. Contractor Originated Designs. Items which the Contract Documents require Contractor to design, detail and incorporate into the permanent works.
13. Controlling Work Items. The activity or work item on the critical path having the least amount of total float. The controlling item of work will also be referred to as a Critical Activity.
14. County. Miami-Dade County, Florida.

15. Culverts. Any structure not classified as a bridge that provides an opening under the roadway.
16. Department. Miami-Dade County Department of Transportation and Public Works.
17. Engineer. The County Engineer, acting directly or through duly authorized representatives; such representatives acting within the scope of the duties and authority assigned to them.
  - a. Note: In order to avoid cumbersome and confusing repetition of expressions in these Specifications, it is provided that whenever anything is, or is to be done, if, as, or, when, or where "acceptable, accepted, approval, approved, authorized, condemned, considered necessary, contemplated, deemed necessary, designated, determined, directed, disapproved, established, given, indicated, insufficient, ordered, permitted, rejected, required, reserved, satisfactory, specified, sufficient, suitable, suspended, unacceptable, or unsatisfactory," it shall be understood as if the expression were followed by the words "by Engineer," "by the Engineer," "to the Engineer," or "of the Engineer."
18. Engineer of Record. The Professional Engineer or Engineering Firm registered in the State of Florida that develops the criteria and concept for the project, performs the analysis, and is responsible for the preparation of the Plans and Specifications. The Engineer of Record may be Departmental in-house staff, or a consultant retained by the Department. Contractor shall not employ the Engineer of Record as Contractor's Engineer of Record or as a Specialty Engineer.
19. Equipment. The machinery and equipment, together with the necessary supplies for upkeep and maintenance thereof, and all other tools and apparatus necessary for the construction and acceptable completion of the work.
20. Extra Work. Any "work" which is required by Engineer to be performed and which is not otherwise covered or included in the project by the existing Contract Documents, whether it be in the nature of additional work, altered work, deleted work, work due to differing site conditions, or otherwise. This term does not include a "delay".
21. Falsework. Includes any temporary construction work used to support the permanent structure until it becomes self-supporting. Falsework includes steel or timber beams, girders, columns, piles and foundations, and any proprietary equipment including modular shoring frames, post shores, and adjustable horizontal shoring.
22. Formwork. Includes any structure or mold used to retain plastic or fluid concrete in its designated shape until it hardens. Formwork comprises common materials such as wood or metal sheets, battens, soldiers and walers, ties, proprietary forming systems such as stay-in-place metal forms, and proprietary supporting bolts, hangers and brackets. Formwork may be either permanent formwork requiring a shop drawing submittal such as stay-in-place metal or concrete forms, or may be temporary formwork which requires certification by the Specialty Engineer for Construction Affecting Public Safety and for Major and Unusual Structures.
23. Highway, Street, or Road. A general term denoting a public way for purposes of vehicular travel, including the entire area within the right-of-way.
24. Holidays. Days designated by Miami-Dade County as holidays, which include, but are not limited to, New Year's Day, Martin Luther King's Birthday, President's Day, Memorial Day, Independence Day, Labor Day, Columbus Day, Veterans Day, Thanksgiving Day and the following Friday, and Christmas Day.
25. Inspector. An authorized representative of the Engineer, assigned to make official inspections of the materials furnished and of the work performed by Contractor.
26. Laboratory. The official testing laboratory authorized by the Department.
27. Major and Unusual Structures: Bridges of complex geometry and/or complex design. Generally, this includes the following types of structures:
  - a. Bridges with an individual span longer than 300 feet.
  - b. Structurally continuous superstructures with spans over 150 feet.
  - c. Steel box and plate girder bridges.
  - d. Steel truss bridges.
  - e. Concrete segmental and longitudinally post-tensioned continuous girder bridges.
  - f. Cable stayed or suspension bridges.
  - g. Arch bridges.
  - h. Tunnels.
  - i. Movable bridges (specifically electrical and mechanical components).
  - j. Rehabilitation, widening, or lengthening of any of the above.
28. Major Item of Work. Any item of work having an original Contract value in excess of 5% of the original Contract amount.
29. Materials. Any substances to be incorporated in the work under the Contract.
30. Median. The portion of a divided highway or street separating the traveled ways for traffic moving in opposite directions.
31. Permanent Works. All the permanent structures and parts thereof required of the completed Contract.
32. Plans. The part of the Contract Documents prepared or approved by the Engineer, including reproductions thereof, which graphically shows or supplements the scope, extent, and character of the Work to be performed by Contractor. Whenever the word "Plans" appears in these Contract Documents, it shall include any related drawings or standard details referenced by the Contract Documents.

33. Right-of-Way. The land that the Department has title to, or right of use, for the road and its structures and appurtenances, and for material pits furnished by the Department.
34. Roadbed. The portion of the roadway occupied by the subgrade and shoulders.
35. Roadway. The portion of a highway within the limits of construction.
36. Scaffolding. An elevated work platform used to support workmen, materials and equipment, but not intended to support the structure.
37. Section. A numbered prime division of these Specifications.
38. Shop Drawings. All working, shop and erection drawings, associated trade literature, calculations, schedules, manuals and similar documents submitted by Contractor to define some portion of the Work. The Work may include both permanent and temporary works as appropriate to the Project. Shop Drawings and other contractor submittals are not Plans as so defined.
39. Shoring. A component of falsework such as horizontal, vertical or inclined support members. In this Section, this term is interchangeable with falsework.
40. Special Erection Equipment. Includes launching gantries, beam and winch equipment, form travelers, stability towers, strong-backs, erection trusses, launching noses or similar items made purposely for construction of the structure. It does not apply to commonly available proprietary construction equipment such as cranes.
41. Special Provisions. Project specific clauses adopted by the Department that add to or revise these Specifications and associated supplemental specifications, or provide other requirements applicable to the Contract.
42. Specialty Engineer.
  - a. A Professional Engineer registered in the State of Florida, other than the Engineer of Record or his subcontracted consultant, who undertakes the design and drawing preparation of components, systems, or installation methods and equipment for specific temporary portions of the Work or for special items of the permanent works not fully detailed in the plans and required to be furnished by Contractor such as but not limited to pot bearing designs, non-standard expansion joints, mechanically stabilized earth wall designs and other specialty items. The Specialty Engineer may also provide designs and details for items of the permanent work declared by the FDOT Construction Office to be "minor" or "non-structural". The Specialty Engineer may be an employee or officer of Contractor or a fabricator, an employee or officer of an entity providing components to a fabricator, or an independent consultant.
    - b. For items of work not specifically covered by Rule 14-75, F.A.C., a Specialty Engineer is qualified if he has the following qualifications:
      - 1) Registration as a Professional Engineer in the State of Florida.
      - 2) The education and experience necessary to perform the submitted design as required by the Florida Board of Professional Engineers.
43. Specifications. The directions, provisions, and requirements contained herein, together with all stipulations contained in the Contract Documents, setting out or relating to the method and manner of performing the work, or to the quantities and qualities of materials and labor to be furnished under the Contract.
44. State. State of Florida.
45. Structure. Any waterworks, drainage works, sewage works, river works, earthworks or constructions of any kind, including those of earth or rock, permanent or temporary, and including bridges, dam, wall, caisson, mast, tower, pylon, underground tank, earth retaining elements or assembly of elements, formwork, falsework, scaffold, fences, poles, buildings, pavings, inlets, levees, tide gates, spillways, drop structures, any structure similar to the foregoing, and any other form of building, construction, arrangement of parts, elements, or materials found in structures.
46. Subarticle. A prime subdivision of an Article of these Specifications.
47. Subgrade. The portion of the roadbed immediately below the base course or pavement, including below the curb and gutter, valley gutter, shoulder and driveway pavement. The subgrade limits ordinarily include those portions of the roadbed shown in the plans to be constructed to a design bearing value or to be otherwise specially treated. Where no limits are shown in the plans, the subgrade section extends to a depth of 12 inches below the bottom of the base or pavement and outward to 6 inches beyond the base, pavement, or curb and gutter.
48. Substantial Completion. The time and date at which the Work has progressed to the point where, in the opinion of Engineer, the Work is sufficiently complete, in accordance with the Contract Documents, so that the Work can be occupied and/or utilized for the purposes for which it is intended. Substantial Completion must occur before the Project is issued a Certificate of Occupancy (or Completion, if applicable) by the Department that allows the County to utilize the entire Project for the purposes for which it is intended. Substantial completion on roadway projects includes completion and operation of traffic signals, street lighting and completion of landscape items.
49. Substructure. All of that part of a bridge structure below the bridge seats, including the parapets, backwalls, and wingwalls of abutments.
50. Superintendent. Contractor's authorized representative in responsible charge of the work.

51. Superstructure. The entire bridge structure above the substructure, including anchorage and anchor bolts, but excluding the parapets, backwalls, and wingwalls of abutments.
52. Surety. The corporate body that is bound by the Contract Bond with and for Contractor and responsible for the performance of the Contract and for payment of all legal debts pertaining thereto.
53. Temporary Works. Any temporary construction work necessary for the construction of the permanent works. This includes but is not limited to bracing, falsework, formwork, scaffolding, shoring, temporary earthworks, sheeting, cofferdams, and special erection equipment.
54. Traveled Way. The portion of the roadway providing for the movement of vehicles, exclusive of shoulders and auxiliary lanes.
55. Traffic Control Signals and Devices. Any signal or device, manually, electrically or mechanically operated, by which traffic is alternately directed to stop and permitted to proceed or controlled in any manner. Traffic control signals and devices regulate, warn, or guide traffic on, over or adjacent to a street, highway, pedestrian facility, or bikeway by authority of a public agency having jurisdiction. Traffic control signals and devices include, but are not limited to, controller assemblies (controller cabinets and their contents); signal heads including their hanging or mounting devices; vehicle detection systems (loops, sealant, amplifier, lead-in wire, or cable); pedestrian detection systems (push button, push button housing, lead-in wires, and signal); motorist information systems, video equipment, network devices, dynamic message signs, highway advisory radios, cameras, vehicle detection systems, and other equipment used within a traffic control system.
56. Underground Facilities. All underground pipelines, conduits, ducts, cables, wires, manholes, vaults, tanks, tunnels, or other such facilities or attachments, and any encasements containing such facilities, including those that convey electricity, gases, steam, liquid petroleum products, telephone or other communications, cable television, water, wastewater, storm water, other liquids or chemicals, or traffic or other control systems.
57. Work. All labor, materials and incidentals required to execute and complete the requirements of the Contract including superintendence, use of equipment and tools, and all services and responsibilities prescribed or implied.
58. Working Day. Any calendar day on which Contractor works or is expected to work in accordance with the approved work progress schedule.

1.02 WORK COVERED BY THE CONTRACT DOCUMENTS

- A. Intent of Contract and Contract Documents
  1. The intent of the Contract and Contract Documents is to describe a functionally complete project (or part

- thereof) to be constructed, and to provide for the construction and completion in every detail of the Work described therein.
2. The intent of the Contract is for Contractor to provide, at no additional cost to the County, all labor, documentation, services, materials, equipment, tools, transportation, and supplies that are:
  - a. Necessary to complete the Work in accordance with the Contract Documents.
  - b. Reasonably inferred and incidental to the Work, whether or not specifically called for by the Contract Documents.

B. Alteration of Plans or of Character of Work

1. Engineer reserves the right to make, at any time prior to or during the progress of the Work, such increases or decreases in quantities, whether a significant change or not, and such alterations in the details of construction, whether a substantial change or not, including but not limited to alterations in the grade or alignment of the road or structure or both, as may be found necessary or desirable by the Engineer. The term "significant change" applies only when the Engineer determines that the character of the work, as altered, differs materially from that involved or included in the original proposed construction.
2. Such increases, decreases or alterations shall not constitute a breach of Contract, shall not invalidate the Contract, nor release the Surety from any liability arising out of this Contract or the Surety bond. Contractor agrees to perform the work, as altered, the same as if it had been a part of the original Work.
3. The Department may require work that is not covered by a price in the Contract if the Department determines that such work does not constitute a significant change and is essential to the satisfactory completion of the Contract within its intended scope. If an adjustment in price is warranted, Engineer will determine the basis of payment for such an adjustment in a fair and equitable amount and authorize the adjustment through an executed Negotiated Acceptance Memorandum (NAM) provided by the Department.
4. In the instance of an alleged significant change, Engineer will review all pertinent information provided by Contractor to determine the validity of the allegation. The determination by Engineer shall be conclusive and shall not be subject to challenge by Contractor in any forum, except upon Contractor establishing by clear and convincing proof that the determination by Engineer was without any reasonable and good-faith basis.

C. Connections to Existing Pavement, Drives and Walks

1. Adhere to the limits of construction at the beginning and end of the Project as detailed in the Contract Documents. However, if Engineer determines that it is necessary to extend the construction in order to make suitable connections to existing pavement, Engineer will authorize such a change.

2. For necessary connections to existing pavement, walks and drives that are not indicated on the Plans, Engineer will provide direction regarding the proper connections in accordance with the applicable Standards.

D. Differing Site Conditions

1. During the progress of the Work, if subsurface or latent physical conditions are encountered at the site differing materially from those indicated in the Contract Documents, or if unknown physical conditions of an unusual nature differing materially from those ordinarily encountered and generally recognized as inherent in the work provided for in the Contract are encountered at the site, the party (County or Contractor) discovering such conditions shall promptly notify the other party in writing of the specific differing conditions before Contractor disturbs the conditions or performs the affected work.
2. Upon receipt of written notification of differing site conditions from Contractor, Engineer will investigate the conditions. If Engineer determines that the conditions materially differ and cause an increase or decrease in the cost or time required for the performance of any work under the Contract, an adjustment will be made, excluding loss of anticipated profits, and the Contract will be modified in writing accordingly. Engineer will notify Contractor whether or not an adjustment of the Contract is warranted.
3. Contractor shall not be entitled to any adjustment in the Contract Price or Contract Times if:
  - a. Contractor knew of the existence of such conditions at the time Contractor made a final commitment to the County with respect to Contract Price and Contract Times by the submission of a Bid; or
  - b. The existence of such condition could reasonably have been discovered or revealed as a result of any examination, investigation, exploration, test, or study of the Site and contiguous areas required by the Bidding Requirements or Contract Documents to be conducted by or for Contractor prior to Contractor's making a Bid; or
  - c. Contractor failed to give the written notice as required by this Article.
4. Engineer will not allow a Contract adjustment for a differing site condition unless Contractor has provided the required written notice.
5. Engineer will not allow a Contract adjustment under this clause for any effects caused to any other Department or non-Department projects on which Contractor may be working.

E. Underground Facilities.

1. It is generally recognized, and Contractor should anticipate that information provided by utility owners during project design, frequently fails to disclose all

Underground Facilities. The fact that more utility lines or other Underground Facilities are located in the Project Site than shown on the Project Plans does not constitute an unforeseen or differing Site Condition and such undisclosed Underground Facilities do not differ materially from the conditions which Contractor should expect.

2. Any information and data shown or indicated in the Contract Documents with respect to existing Underground Facilities at or contiguous to the Site is based on information and data furnished to the County design engineer by the owners of such Underground Utilities. Additional utilities may exist which are not shown in the Contract Documents. Unless it is otherwise expressly stated in the Special Provisions, the County is not responsible for the accuracy or completeness of any such information or data provided
3. Contractor is responsible for field verification and location of all Underground Facilities prior to the start of construction. No field work shall be allowed to start until Contractor has notified Sunshine State One-Call of Florida, Inc. and all affected utilities have been located. In addition, Contractor, without any additional compensation, must expose and physically locate all potentially conflicting Underground Facilities prior to construction and is fully responsible for:
  - a. Reviewing and checking all Underground Facilities information and data;
  - b. Locating and verifying all Underground Facilities at or contiguous to the Site;
  - c. Coordination of the Work with the owners of such Underground Facilities, including the County, during construction; and
  - d. The safety and protection of all such Underground Facilities and repairing any damage thereto resulting from the Work.
4. The actual locations of the Underground Facilities must be compared to locations shown on the Plans and any required changes in alignment and grade must be made at the time of construction in consultation with Engineer.
5. If an Underground Utilities is uncovered or revealed at or contiguous to the Site which was not shown or indicated, or not shown or indicated with reasonable accuracy in the Contract Documents:
  - a. Identify the owner of such Underground Facilities and give written notice to that owner and to Engineer promptly after becoming aware thereof and before further disturbing conditions affected thereby or performing any Work in connection therewith. During such time, Contractor shall be responsible for the safety and protection of such Underground Facility.
  - b. Engineer will promptly review the Underground Facilities and determine the extent, if any, to which a change is required in the Contract Documents to reflect and document the consequences of the existence or location of the Underground Facility. If

Engineer determines that the conditions materially differ and cause an increase or decrease in the cost or time required for the performance of the Work, an adjustment will be made, excluding loss of anticipated profits, and the Contract will be modified in writing accordingly. Engineer will notify Contractor whether or not an adjustment of the Contract is warranted.

F. Contractor Proposed Changes Affecting Utilities

1. Contractor is responsible for identifying and assessing any potential impacts to a utility that may be caused by the changes proposed by Contractor, and Contractor must, at the time of making the request for a change, notify the Department in writing of any such potential impacts to utilities.
2. Department approval of a Contractor proposed change does not relieve Contractor of sole responsibility for all utility impacts, costs, delays or damages, whether direct or indirect, resulting from Contractor initiated changes in the design or construction activities from those in the original Contract Specifications, design plans (including traffic control plans) or other Contract Documents and which effect a change in utility work different from that shown in the utility plans, joint project agreements or utility relocation schedules.

G. Rights in and Use of Materials Found on the Site of the Work

1. Ownership and Disposal of Existing Materials: Unless otherwise directed by Engineer or elsewhere in the Contract Documents, take ownership and dispose of all materials that are not designated as the property of other parties, in both roadway and structures, found on the right-of-way, and all material in structures designated for removal. Such materials do not include earth or other excavated material required for the construction of the Project. During construction, Contractor may use materials from existing structures that are required to be removed and that are designated to remain the property of the Department. Do not cut or otherwise damage such material during removal unless Engineer gives permission to do so. Store material in an accessible location as Engineer directs. The Department is not responsible for the quality or quantity of any material salvaged.
2. Ornamental Trees and Shrubs: Take ownership of all ornamental trees or shrubs existing in the right-of-way that are required to be removed for the construction operations and which are not specifically designated on the Plans to be reset, relocated, or to be removed by others prior to the construction operations.

H. Restoration of Property

1. Take preconstruction videos/pictures of the entire work zone and adjacent areas.
2. Public or private property damaged during construction or removed for convenience of the Work

must be repaired or replaced at Contractor's expense in a manner acceptable to Engineer, prior to final acceptance of the Work or sooner if otherwise required by the Contract Documents or Engineer. This includes, but is, not limited to signalization equipment and miscellaneous hardware removed from the construction site, signs, driveways, landscaping, sidewalk, walkways, walls, fences, footings, underground utilities, etc.

3. Contractor must comply with the requirements of Miami-Dade County Code Section 2-103.1 (b), CONSTRUCTION OF PUBLIC UTILITIES OR WORKS IN PUBLIC RIGHTS-OF-WAY

- a. "Whenever any person, corporation, partnership, association, County Department or other legal entity performs any construction or public work within an existing right-of-way located within unincorporated Miami-Dade County, or in right-of-ways of roads or streets located within municipalities that are maintained by the County, the right-of-way, including sidewalks, curbs and gutters, landscaping and must be restored to their legally permissible preexisting condition, including any aesthetic enhancements thereto and any adjacent private property damaged during construction, within thirty (30) days of completion of the construction or public work in that right of way or within thirty (30) days of damage to the affected property or area, whichever occurs first. Prior to the time such construction work begins, the contractor, by posting the construction site, shall inform the local community of the requirement to restore the right-of-way as well as any affected adjacent private property and the fines that could be imposed for each failure to do so. All work to be done pursuant to this Section shall be performed in compliance with the Public Works Manual. Any entity failing to restore the right-of-way to its preexisting condition or better within the time permitted shall be subject to a civil fine of five hundred dollars (\$500.00) per violation per day until such time as the right-of-way is restored, as well as five hundred dollars (\$500.00) per day for each affected adjacent private property until it is restored." Contractor may obtain a complete copy of the Ordinance from the Clerk of the Board.
- b. Post the construction site pursuant to Miami-Dade County Code Section 2-103 (b). The Public Notice to be posted is to read as follows:

**PUBLIC NOTICE  
ORDINANCE NO. 03-89**

*Contractor shall restore the right-of-way as well as any affected adjacent private property within 30 days of completion of construction or damage to the affected property or area, whichever occurs first.*

*Any entity failing to restore the right-of-way to its pre-existing condition or better within the time promoted shall be subject to a civil fine of \$500 per violation per day.*

4. Survey monuments.
  - a. Upon completion of construction activities and prior to the expiration of the Contract:
    - 1) Coordinate the replacement of any monument(s) disturbed or destroyed.
    - 2) Submit to Engineer for review and approval, a survey report that includes all monuments replaced and all monuments impacted as a result of construction activities.
  - b. The replacement of monuments and the preparation of the survey report must be by a licensed Florida Surveyor and Mapper and meet all applicable State Rules, Statutes, and requirements of the Department. All costs required for compliance with these requirements will be included among the Contract pay items.
5. Failure to Restore Damaged Property:
  - a. In case of failure on the part of Contractor to restore such property, bridge, road or street, or to make good such damage or injury, Engineer may, upon 48 hours notice, proceed to repair, rebuild, or otherwise restore such property, road, or street as may be deemed necessary, and the Department will deduct the cost thereof from any monies due or which may become due Contractor under the Contract. Nothing in this clause prevents the Contractor from receiving proper compensation for the removal, damage, or replacement of any public or private property, not shown on the plans, that is made necessary by alteration of grade or alignment. Engineer will authorize such work, provided that Contractor, or his employees or agents, have not, through their own fault, damaged such property.
6. Work Site Clean-Up:
  - a. Debris and trash shall be removed from the site daily. Mow turf or vegetation within the project limits in accordance with Article 107 of the Construction Specifications.
  - b. Upon completion of all work specified herein at each work site and before acceptance and

payment is made, Contractor shall remove from each work site all machinery, equipment, surplus and discarded materials, rubbish and temporary structures. Material cleared from site and deposited on adjacent property will not be considered as having been disposed of satisfactorily.

I. Final Cleaning Up of Right-of-Way

1. Upon completion of the Work, and before the Department accepts the Work and makes final payment, remove from the right-of-way and adjacent property all falsework, equipment, surplus and discarded materials, rubbish and temporary structures; restore in an acceptable manner all property, both public and private, that has been damaged during the prosecution of the work; and leave the waterways unobstructed and the roadway in a neat and presentable condition throughout the entire length of the work under Contract. Clean all areas impacted by the Work and remove sedimentation in drainage structures caused by the construction activities.
2. Do not dispose of materials of any character, rubbish or equipment, on abutting property, with or without the consent of the property owners. Engineer will allow Contractor to temporarily store equipment, surplus materials, usable forms, etc., on a well-kept site owned or leased by Contractor, adjacent to the Project. However, do not place or store discarded equipment, materials, or rubbish on such a site.
3. Shape, dress and restore areas adjacent to the Project right-of-way that were used as plant sites, materials storage areas or equipment yards when they are no longer needed for such purposes.

1.03 CONTROLLING WORK

A. Plans

1. Contract Documents: Have one complete copy of the Contract Documents available on the worksite at all times.
2. Department's Plans: Unless otherwise labeled, all Items shown on the Plans are considered to be part of the Work, and must be incorporated into the Work and included in the established prices.
3. Alterations in Plans: The Department will issue, in writing, all authorized alterations affecting the requirements and information given on the approved plans.

B. Typical Details and/or Sketches

1. Typical details and/or sketches regarding the proposed work may be provided in addition to the standard details that are available in the Miami-Dade County Public Works Manual and the latest edition of the Florida Department of Transportation's Design Standards for Design, Construction, Maintenance and Utility Operations on The State Highway System.

2. County through its Engineer shall have the right to modify the details and/or sketches, to supplement the sketches with additional plans and/or with additional information as work proceeds; all of which shall be considered as plans accompanying these Specifications herein generally referred to as the "Plans." In case of disagreement between the Plans and Specifications, Engineer will make a final determination as to which will govern.

C. Or-Equals and Substitutes

1. Except where specifically provided, whenever material or equipment is specified or described in the Contract Documents by proprietary name or as being available from a particular supplier, the intent is to establish the type, function, appearance, and quality required. A written request to Engineer to authorize an "or-equal" or "substitute" material or equipment may be submitted as described below unless the item specified or described contains or is followed by words reading that no like, equivalent, or "or-equal" item or no substitution is permitted.

a. Or-Equal Material or Equipment:

- 1) Material or equipment proposed by Contractor may be considered by Engineer as an "or equal" item if in Engineer's sole discretion the item proposed is functionally equal and sufficiently similar to that specified or described in the Contract Documents and that no change in related Work will be required.
- 2) Contractor has the burden of proving at Contractor's own cost and expense, to the satisfaction of Engineer, that the proposed item is equal to the named item. If Contractor fails to comply with the provisions of this Article, or if Engineer determines that the proposed item is not equal to that named, Contractor must supply the product named.
- 3) For the purposes of this Article and at Engineer's sole discretion, a proposed item of material or equipment will be considered functionally equal to the item specified or described in the Contract Documents if:
  - a) In the exercise of reasonable judgment Engineer determines that the proposed item is at least equal in materials of construction, quality, durability, appearance, strength, and design characteristics; will reliably perform at least equally well the function and achieve the results imposed by the design concept of the completed Project as a functioning whole; has a proven record of performance and availability of responsive service; and
  - b) Contractor certifies that, if approved and incorporated into the Work, there will be no increase in cost to the County or increase in Contract Times, and the proposed item will conform substantially

to the detailed requirements of the item named in the Contract Documents.

b. Substitute Material or Equipment:

- 1) If in Engineer's sole discretion an item of material or equipment proposed by Contractor does not qualify as an "or-equal" item, it may be proposed for consideration as a substitute item by Contractor submitting sufficient information as stipulated below to allow Engineer to determine that the item of material or equipment proposed is essentially equivalent to and an acceptable substitute for that named. Requirements pertaining to a proposed substitute item request for review by Engineer will be as set forth in this Article, as supplemented in the Contract Documents, and as Engineer may decide are appropriate under the circumstances.

- 2) Contractor must make written application to Engineer for review of a proposed substitute item of material or equipment that Contractor seeks to furnish or use. The application shall:

- a) Certify that the proposed substitute item will perform adequately the functions and achieve the results called for by the general design, be similar in substance to that specified, and be suited to the same use as that specified;
- b) State the extent, if any, to which the use of the proposed substitute item will prejudice Contractor's achievement of Substantial Completion on time; whether or not use of the proposed substitute item in the Work will require a change in any of the Contract Documents to adapt the design to the proposed substitute item; and whether or not incorporation or use of the proposed substitute item in connection with the Work is subject to payment of any license fee or royalty;
- c) Identify all variations of the proposed substitute item from that specified, and available engineering, sales, maintenance, repair, and replacement services;
- d) Contain an itemized estimate of all costs or credits that will result directly or indirectly from use of such substitute item, including costs of redesign and claims of other contractors affected by any resulting change.

2. Substitute Construction Methods or Procedures: If a specific means, method, technique, sequence, or procedure of construction is expressly required by the Contract Documents, Contractor may furnish or utilize a substitute means, method, technique, sequence, or procedure of construction approved by Engineer. For Engineer approval, submit sufficient information to allow Engineer, in Engineer's sole discretion, to determine that the substitute proposed is equivalent to that expressly called for by the Contract Documents. The requirements for review by Engineer will be as set



forth in this Article, as supplemented in the Contract Documents, and as Engineer may decide are appropriate under the circumstances.

3. Engineer's Evaluation: Engineer will be allowed a reasonable time within which to evaluate each proposal or submittal made pursuant to this Article and will be the sole judge of acceptability. Engineer may require Contractor to furnish additional data about the proposed substitute item. No "or equal" or substitute will be ordered, installed or utilized until Engineer's review is complete, which will be evidenced by receipt from Engineer of either a written approval or Change order where required for a substitute; or an approved Shop Drawing or written approval for an "or equal." Engineer will advise Contractor in writing of any negative determination. Contractor shall provide all data in support of any proposed substitute or "or-equal" at Contractor's expense. County may require Contractor to furnish at Contractor's expense a special performance guarantee or other surety with respect to any substitute item.
4. Engineer's Cost Reimbursement: Engineer will record Engineer's costs in evaluating a substitute proposed or submitted by Contractor pursuant to this Article whether or not Engineer approves a substitute item so proposed or submitted by Contractor, Contractor shall reimburse the County for the costs for evaluating each such proposed substitute. Contractor shall also reimburse the County for the costs of making changes in the Contract Documents from the acceptance of each proposed substitute.

#### D. Right Of Way Verification

1. All Work and improvements shall be performed, constructed and installed within the limits of the existing Right-of-Way pursuant to the Contract Documents.
2. Obtain all necessary documentation for verifying rights-of-way and property lines.
3. Retain a Florida Registered Surveyor and Mapper to obtain right-of-way and property lines by examining available rights-of-way maps, plats, occupation, legal descriptions or other legal documents or means. The Surveyor will layout the required alignments and grades and be responsible for their accuracy.
4. All field notes on this Project must be kept in a dedicated field book. Submit all field books to Engineer once the Project is completed or prior to completion when a field book gets filled.
5. All costs for complying with these requirements are included under the several scheduled items of the overall Contract. Therefore, no separate payment will be made for this work.

#### E. Shop Drawings

1. Shop Drawings:
  - a. General. Prepare and submit whatever detailed working drawings necessary to fabricate, erect, and construct all parts of the

Work in conformity with the Plans and Specifications. Shop drawings shall be submitted to Engineer; two sets will be returned to Contractor approved or showing the changes or corrections required; if changes or corrections are required, four revised copies shall be resubmitted until they are approved. Payment for shop drawings and required documents, revisions thereof, and for all copies furnished, shall be included in the various items of work bid. Contractor should allow a minimum of 14 days for the County's approval of shop drawings. County is not responsible for errors or minor discrepancies of Contractor's drawings, even though approved.

- b. Work Items Requiring Shop Drawings: In general, the Department requires shop drawings for items of work not fully detailed in the plans which require additional drawings and coordination prior to constructing the item, including but not limited to:
  - 1) Bridge components not fully detailed in the plans
  - 2) Retaining Wall Systems
  - 3) Precast Box Culverts
  - 4) Non-standard lighting, signalization and signing structures and components
  - 5) Building structures
  - 6) Drainage structures, attenuators, and other nonstructural items
  - 7) Design and structural details furnished by Contractor in compliance with the Contract
  - 8) Temporary Works affecting public safety.
- c. Schedule of Submittals: Prepare and submit a schedule of submittals that identifies the work for which shop drawings apply. For each planned submittal, define the type, and approximate number of drawings or other documents that are included and the planned submittal date, considering the processing requirements herein. Submit the schedule of submittals to Engineer at the preconstruction conference, and prior to the submission of any shop drawings. Coordinate subsequent submittals with construction schedules to allow sufficient time for review, approval, and re-submittal as necessary.
- d. Style, Numbering, and Material of Submittals:
  - 1) Drawings: Furnish four clearly legible copies of all shop drawings that are necessary to complete the structure in compliance with the design shown on the Plans. Prepare all shop drawings using the same units of measure as those used in the Plans. Use sheets no larger than 11 by 17 inches unless otherwise required by Engineer. Consecutively number each sheet in the submittal series, and indicate the total number in the series (i.e., 1

of 12, 2 of 12, . . . , 12 of 12). Include on each sheet the following items as a minimum requirement: the Project Number, Bridge Number(s), drawing title and number, a title block showing the names of the fabricator or producer and Contractor for which the work is being done, the initials of the person(s) responsible for the drawing, the date on which the drawing was prepared, the location of the item(s) within the Project, Contractor's approval stamp with date and initials, and, when applicable, the documents shall be signed and sealed by the Specialty Engineer or Contractor's Engineer of Record, as appropriate. A re-submittal will be requested when any of the required information is not included.

- 2) Other Documents: Provide four sets of original documents or clearly legible copies of documents other than drawings, such as trade literature, catalogue information, calculations, and manuals. Provide sheets no larger than 11 by 17 inches unless otherwise required by Engineer. Clearly label and number each sheet in the submittal to indicate the total number of sheets in the series (i.e., 1 of 12, 2 of 12, . . . , 12 of 12). Additional sets of documentation may be required by Engineer for review of precast prestressed and structural steel components.
- 3) Prepare all documents using the same units of measure as those used in the Contract Documents. Bind and submit all documents with a Table of Contents cover sheet. List on the cover sheet the total number of pages and appendices, and include the Project Number, a title referencing the submittal item(s), the name of the firm and person(s) responsible for the preparation of the document, Contractor's approval stamp with date and initials, and, when applicable, the documents shall be signed and sealed by the Specialty Engineer or Contractor's Engineer of Record, as appropriate.
- 4) Submit appropriately prepared and checked calculations and manuals that clearly outline the design criteria. Include on the internal sheets the Project Number and the initials of the person(s) responsible for preparing and checking the document.
- 5) Clearly label trade literature and catalogue information on the front cover with the title, Project Number, date and name of the firm and person(s) responsible for that document.

e. Submittal Paths and Copies:

- 1) General: Submit shop drawings to Engineer or Engineer's duly authorized representative. At the preconstruction conference, the Department will notify Contractor of any changes in the submittal path and whether the Department's or the Consultant's review stamp will signify an officially reviewed shop

drawing. When the Engineer of Record is a consultant hired by the Department, submit shop drawings to the consultant with a copy to Engineer. For work requiring other documentation (e.g., catalog data, procedure manuals, fabrication/welding procedures, and maintenance and operating manuals), submit the required number of copies with the prints. If not shown on the plans, the Department will furnish the mailing address of the Consulting Engineer of Record. Provide copies of material certifications and material tests to Engineer.

- 2) Contractor-Originated Design: Submit shop drawings and applicable calculations to the Engineer of Record for review. Ensure that each sheet of the shop drawings and the cover sheet of the calculations are signed and sealed by the Specialty Engineer or Contractor's Engineer of Record. Transmit the submittal and copies of the transmittal letters in accordance with the submittal requirements stipulated herein.
- 3) Temporary Works: For Construction Affecting Public Safety, submit to the Engineer of Record shop drawings and the applicable calculations for the design of special erection equipment, bracing, falsework, scaffolding, etc. Ensure that each sheet of the shop drawings and the cover sheet of the applicable calculations is signed and sealed by the Specialty Engineer. Transmit the submittal and copies of the transmittal letters in accordance with the submittal requirements stipulated herein.
- 4) Formwork and Scaffolding: Contractor is solely responsible for the safe installation and use of all formwork and scaffolding. The Department does not require any formwork or scaffolding submittals unless such work would be classified as Construction Affecting Public Safety or called for by the Contract Documents.
- 5) Beam and Girder Temporary Bracing: Contractor is solely responsible for ensuring stability of beams and girders during all handling, storage, shipping and erection. Adequately brace beams and girders to resist wind, weight of forms and other temporary loads, especially those eccentric to the vertical axis of the products, considering actual beam geometry and support conditions during all stages of erection and deck construction. Develop the required designs following the AASHTO Guide Design Specifications for Bridge Temporary Works and Construction Handbook for Bridge Temporary Works and the Contract Documents.
- 6) For Construction Affecting Public Safety, submit signed and sealed calculations for stability for all beams and girders.

- 7) Erection Plan: Submit, for Engineer's review, an Erection Plan that meets the specific requirements of FDOT Sections 450, 452 and 460 and this section. Refer to FDOT Design Standards Index 600 for construction activities not permitted over traffic.
  - 8) Other Miscellaneous Design and Structural Details Furnished by Contractor in Compliance with the Contract: Submit to Engineer any shop drawings and applicable calculations. Ensure that each sheet of the shop drawings and the cover sheet of the applicable calculations is signed and sealed by the Specialty Engineer. Transmit the submittal and copies of the transmittal letters in accordance with the submittal requirements stipulated herein.
- f. Processing of Shop Drawings:
- 1) Contractor Responsibility for Accuracy and Coordination of Shop Drawings:
    - a) Coordinate, schedule, and control all submittals, with a regard for the required priority, including those of the various subcontractors, suppliers, and engineers, to provide for an orderly and balanced distribution of the work.
    - b) Submit shop drawings to facilitate expeditious review. Contractor is discouraged from transmitting voluminous submittals of shop drawings at one time. For submittals transmitted in this manner, allow for the additional review time that may result.
    - c) Only shop drawings distributed that have been approved by the Department are valid. Any work that Contractor performs in advance of approval will be at Contractor's risk.
  - 2) Scope of Review by Engineer: The Engineer of Record's review of the shop drawings is for conformity to the requirements of the Contract Documents and to the intent of the design. The Engineer of Record's review of shop drawings which include means, methods, techniques, sequences, and construction procedures are limited to the effects on the permanent works. The Engineer of Record's review of submittals which include means, methods, techniques, sequences, and construction procedures does not include an in-depth check for the ability to perform the work in a safe or efficient manner. Review by the Engineer of Record does not relieve Contractor of responsibility for dimensional accuracy to ensure field fit and for conformity of the various components and details.
  - 3) Special Review by Engineer of Shop Drawings for Construction Affecting Public Safety: For Construction Affecting Public Safety, the Engineer of Record, or other Engineer as the Department appoints for this purpose, will make an independent review of all relevant shop drawings and similar documents. Do not proceed with construction of the permanent works until receiving the Engineer of Record's approval. The review of these shop drawings is for overall structural adequacy of the item to support the imposed loads and does not include a check for economy, efficiency or ease of construction.
- g. Other Requirements for Shop Drawings for Bridges:
- 1) Shop Drawings for Structural Steel and Miscellaneous Metals: Furnish shop drawings for structural steel and miscellaneous metals. Shop drawings shall consist of working, shop, and erection drawings, welding procedures, and other working plans, showing details, dimensions, sizes of material, and other information necessary for the complete fabrication and erection of the metal work.
  - 2) Shop Drawings for Concrete Structures: Furnish shop drawings for concrete components that are not cast-in-place and are not otherwise exempted from submittal requirements. Also, furnish shop drawings for all details that are required for the effective prosecution of the concrete work and are not included in the Contract Documents such as: special erection equipment, masonry layout diagrams, and diagrams for bending reinforcing steel, in addition to any details required for concrete components for the permanent work.
  - 3) Shop Drawings for Major and Unusual Structures: In addition to any other requirements, within 60 days from the Notice to Proceed, submit information to Engineer outlining the integration of the Major and Unusual Structure into the overall approach to the project. Where applicable to the project, include, but do not limit this information to:
    - a) The overall construction program for the duration of the Contract. Clearly show the Milestone dates.
    - b) The overall construction sequence. The order in which individual structures are to be built, the sequence in which individual spans of girders or cantilevers are erected, and the sequence in which spans are to be made continuous.
    - c) The general location of any physical obstacles to construction that might impose restraints or otherwise affect the construction, and an outline of how to deal with such obstacles while building the structure(s).
    - d) The approximate location of any special lifting equipment in relation to the structure, including clearances required for the operation of the equipment.

- e) The approximate location of any temporary falsework, and the conceptual outline of any special erection equipment. Provide the precise locations and details of attachments, fixing devices, loads, etc. in later detailed submittals.
- f) An outline of the handling, transportation, and storage of fabricated components, such as girders or concrete segments. Provide the precise details in later detailed submittals.
- g) Any other information pertinent to the proposed scheme or intended approach.
- h) Clearly and concisely present the above information on as few drawings as possible in order to provide an overall, integrated summary of the intended approach to the project. The Department will use these drawings for information, review planning, and to assess Contractor's approach in relation to the intent of the original design. The delivery to and receipt by Engineer does not constitute any Department acceptance or approval of the proposals shown thereon. Include the details of such proposals on subsequent detailed shop drawing submittals. Submit timely revisions and re-submittals for all variations from these overall scheme proposals.
- h. Cost of Shop Drawings: Include the cost of furnishing shop and working drawings in the Contract prices for the work requiring the shop and working drawings. The Department will not pay Contractor additional compensation for such drawings.

## 2. Certifications:

- a. Special Erection Equipment: Prior to its use, ensure that the Specialty Engineer personally inspects the special erection equipment and certifies to Engineer in writing that the equipment has been fabricated in accordance with the submitted drawings and calculations. In addition, after assembly, ensure that the Specialty Engineer observes the equipment in use and certifies to Engineer in writing that it is being used as intended and in accordance with the submitted drawings and calculations. In each case, ensure that the Specialty Engineer also signs and seals the letter of certification.
- b. Falsework and Shoring Requiring Shop Drawings: After its erection or installation but prior to the application of any superimposed load, ensure that the Specialty Engineer personally inspects the falsework and certifies to Engineer in writing that the falsework has been constructed in accordance with the materials and details shown on the submitted drawings and calculations. Ensure that the Specialty

Engineer also signs and seals the letter of certification.

- c. Temporary Formwork: For Construction Affecting Public Safety and for Major and Unusual Structures, prior to the placement of any concrete, ensure that the Specialty Engineer inspects the formwork and certifies to Engineer in writing that the formwork has been constructed to safely withstand the superimposed loads to which it will be subjected. Ensure that the Specialty Engineer signs and seals the letter of certification.
- d. Erection: For Construction Affecting Public Safety, submit an erection plan signed and sealed by the Specialty Engineer to Engineer at least four (4) weeks prior to erection commencing. Include as part of this submittal signed and sealed calculations and details for any falsework, bracing or other connection(s) supporting the structural elements shown in the erection plan.
- e. At least two (2) weeks prior to beginning erection, conduct a Preerection meeting with the Specialty Engineer and Engineer to review details of the plan.
- f. After erection of the elements but prior to opening of the roadway below the structure, ensure that a Specialty Engineer has personally inspected the erected member(s) and certified to Engineer that the structure has been erected in accordance with the signed and sealed erection plan.
- g. Perform daily inspections of the erected structural systems. For structures without temporary supports but with temporary girder bracing systems, perform inspections until all the diaphragms and cross frames are in place. For structures with temporary supports, perform inspections until the temporary supports are no longer needed as indicated in the erection plans. Provide written documentation of the inspections to Engineer within 24 hours of the inspection.

## 3. Corrections for Construction Errors:

- a. For work that Contractor constructs incorrectly or does not meet the requirements of the Contract Documents, Contractor has the prerogative to submit an acceptance proposal to Engineer for review and disposition. The acceptance proposal shall describe the error or defect and either describe remedial action for its correction or propose a method for its acceptance. In either case, the acceptance proposal shall address structural integrity, aesthetics, maintainability, and the effect on Contract Time. The Department will judge any such proposal for its effect on these criteria and also for its effect on Contract Administration.
- b. When Engineer judges that a proposal infringes on the structural integrity or maintainability of the structure, Contractor's

Engineer of Record will perform a technical assessment and submit it to Engineer for approval.

- c. Do not take any corrective action without Engineer's approval. Carry out all approved corrective construction measures at no expense to the County.
- d. Notwithstanding any disposition of the compensation aspects of the defective work, Engineer's decision on the technical merits of a proposal is final.

F. Coordination of Contract Documents

1. These Specifications, the Plans, Special Provisions, and all supplementary documents are integral parts of the Contract; a requirement occurring in one is as binding as though occurring in all.
2. All parts of the Contract Documents are complementary and describe and provide for a complete work. In addition to the work and materials specified in the Specifications as being included in any specific pay item, include in such pay items additional, incidental work, not specifically mentioned, when so shown in the plans, or if indicated, or obvious and apparent, as being necessary for the proper completion of the work under such pay item and not stipulated as being covered under other pay items.
3. Promptly notify Engineer in writing of any conflict, error, ambiguity, omission or discrepancy which Contractor may discover within the Contract Documents and obtain a written interpretation or clarification from Engineer before proceeding with any work affected thereby. The higher quality, greater quantity, more specific or restrictive, or more expensive requirement necessary and applicable to the completed Project, based on Engineer's interpretation, will take precedence. Engineer's written decision on the issue will be final and binding.

G. Conformity of Work with Contract Documents

1. Perform all work and furnish all materials in conformity with the lines, grades, cross-sections, dimensions, and material requirements, including tolerances, as specified in the Contract Documents.
2. In the event that Engineer finds that Contractor has used material or produced a finished product that is not in conformity with the Contract Documents, but that Contractor has produced reasonably acceptable work, Engineer will determine if the Department will accept the work. In this event, Engineer will document the basis of acceptance by Contract modification, which provides for an appropriate reduction in the Contract price for such work or materials included in the accepted work as deemed necessary to conform to the determination based on engineering judgment.
3. In the event that Engineer finds that Contractor has used material or produced a finished product that is not in conformity with the Contract Documents, and that Contractor has produced an inferior or unsatisfactory product, Contractor shall remove and

replace or otherwise correct the work or materials at no expense to the County.

4. For base and surface courses, the Department will allow the finished grade to vary as much as 0.1 foot from the grade shown in the plans, provided that Contractor's work meets all templates and straightedge requirements and contains suitable transitions.

H. Errors or Omissions in Contract Documents

1. Do not take advantage of any apparent error or omission discovered in the Contract Documents, but immediately notify Engineer of such discovery. Engineer will then make such corrections and interpretations as necessary to reflect the actual spirit and intent of the Contract Documents.

I. Authority of Engineer

1. Perform all work to the satisfaction of Engineer. Engineer will decide all questions, difficulties, and disputes, of whatever nature, that may arise relative to the interpretation of the Plans, construction, prosecution, and fulfillment of the Contract, and as to the character, quality, amount, and value of any work done, and materials furnished, under or by reason of the Contract.

J. Authority and Duties of Engineer's Assistants

1. Engineer's assistants and representatives are authorized to inspect all work done and all materials furnished. Such inspection may extend to all or any part of the work and to the manufacture, preparation, or fabrication of the materials to be used. Such assistants and representatives are not authorized to revoke, alter, or waive any requirement of these Specifications. Rather, they are authorized to call to the attention of Contractor any failure of the work or materials to meet the Contract Documents, and have the authority to reject materials or suspend the work until any questions at issue can be referred to and decided by Engineer.
2. Engineer will immediately notify Contractor in writing of any such suspension of the work, stating in detail the reasons for the suspension. The presence of the inspector or other assistant in no way lessens the responsibility of Contractor.

K. Engineering and Layout

1. Control Points Furnished by the Department:
  - a. Engineer will provide centerline control points (Begin Project, End Project, PIs, PTs, etc.) and bench marks at appropriate intervals along the line of the project to facilitate the proper layout of the work. Normally, Engineer will furnish only one bench mark for water crossings. Preserve all reference points and bench marks that the Department furnishes.

- b. As an exception to the above, for projects where the plans do not show a centerline or other survey control line for construction of the work (e.g. resurfacing, safety modifications, etc.) Engineer will provide only points marking the beginning and ending of the project, and all exceptions.
2. Furnishing of Stake Materials: Furnish all stakes, templates, and other materials necessary for establishing and maintaining the lines and grades necessary for control and construction of the Work.
  3. Layout of Work:
    - a. Utilizing the control points furnished by the Department, establish all horizontal and vertical controls necessary to construct the work in conformity to the Contract Documents. Perform all calculations required, and set all stakes needed such as grade stakes, offset stakes, reference point stakes, slope stakes, and other reference marks or points necessary to provide lines and grades for construction of all roadway, bridge, and miscellaneous items.
    - b. When performing utility construction as part of the project, establish all horizontal and vertical controls necessary to carry out such work.
  4. Specific Staking Requirements:
    - a. When performing new base construction as part of the Project, set stakes to establish lines and grades for subgrade, base, curb, and related items at intervals along the line of the work no greater than 50 feet on tangents and 25 feet on curves. Set grade stakes at locations that Engineer directs to facilitate checking of subgrade, base, and pavement elevations in crossovers, intersections, and irregular shaped areas.
    - b. For bridge construction stakes and other control, set references at sufficiently frequent intervals to ensure construction of all components of a structure in accordance with the lines and grades shown in the plans.
    - c. For projects where the plans do not show a centerline or other survey control line for construction of the work (resurfacing, safety modifications, etc.), provide only such stakes as necessary for horizontal and vertical control of work items.
    - d. For resurfacing and resurfacing-widening type projects, establish horizontal controls adequate to ensure that the asphalt mix added matches with the existing pavement. In tangent sections, set horizontal control points at 100 foot intervals by an instrument survey. In curve sections, set horizontal control points at 25 foot intervals by locating and referencing the centerline of the existing pavement.
    - e. Establish by an instrument survey, and mark on the surface of the finished pavement at 25 foot intervals, the points necessary for striping of the finished roadway. As an exception, for resurfacing and resurfacing/widening projects, establish these points in the same manner as used for horizontal control of paving operations. Mark the pavement with white paint. If performing striping, Engineer may approve an alternate method for layout of striping provided that Contractor achieves an alignment equal to or better than the alignment that would be achieved using an instrument survey.
  5. Personnel, Equipment, and Record Requirements:
    - a. Employ only competent personnel and use only suitable equipment in performing layout work. Do not engage the services of any person or persons, employed by the Department, for performance of layout work.
    - b. Keep adequate field notes and records while performing layout work. Make these field notes and records available for Engineer's review as the work progresses, and furnish copies to Engineer at the time of completion of the project. Engineer's inspection, checking, or acceptance of Contractor's field notes or layout work does not relieve Contractor of his responsibility to achieve the lines, grades, and dimensions shown in the Contract Documents.
    - c. Prior to final acceptance of the project, mark, in a permanent manner on the surface of the completed work, all horizontal control points originally furnished by the Department.
  6. Payment: Include the cost of performing layout work as described above in the Contract unit prices for the various items of work that require layout.

L. Contractor's Supervision

1. Contractor's Superintendent:

- a. Maintain a competent superintendent at the Site at all times while work is in progress to act as Contractor's agent. The superintendent must:
  - 1) Be capable of properly interpreting the Contract Documents and thoroughly experienced in the type of work being performed.
  - 2) Have full authority to receive instructions from Engineer and to execute the orders or directions of the Engineer, including promptly supplying any materials, tools, equipment, labor, and incidentals that may be required.
  - 3) Speak and understand English.
- b. Maintain at least one other responsible person who speaks and understands English, on the Project during all working hours.
- c. Furnish sufficient superintendence and supervisory personnel commensurate to the amount and type of work being performed.

2. Supervision for Emergencies:

- a. Provide a responsible person, who speaks and understands English, and who is available at or reasonably near the worksite on a 24 hour basis, seven days a week. Designate this person as the point of contact for emergencies and in cases that require immediate action to maintain traffic or to resolve any other problem that might arise.
- b. Submit, by certified mail, the phone numbers and names of personnel designated to be contacted in cases of emergencies, along with a description of the project location, to the Miami-Dade Police and all other local law enforcement agencies.

M. General Inspection Requirements

1. Cooperation by Contractor:

- a. Notify Engineer daily where each of his crews will be working and what work will be done. This notification shall be given each weekday between 3:00 p.m. and 4:00 p.m. on the prior day.
- b. Do not perform work or furnish materials without obtaining inspection by Engineer or his representative. Furnish Engineer with every reasonable facility for ascertaining whether the work performed and materials used are in accordance with the requirements and intent of the Contract Documents.
- c. If Engineer so requests at any time before final acceptance of the work, remove or uncover such portions of the finished work as

directed. After examination, restore the uncovered portions of the work to the standard required by the Contract Documents. If Engineer determines that the work so exposed or examined is unacceptable, perform the uncovering or removal, and the replacing of the covering or making good of the parts removed, at no expense to the County. However, if Engineer determines that the work thus exposed or examined is acceptable, the County will pay for the uncovering or removing, and the replacing of the covering or making good of the parts removed in accordance with the terms of the Contract Documents.

- 2. Failure of Engineer to Reject Work During Construction: If, during or prior to construction operations, Engineer fails to reject defective work or materials, whether from lack of discovery of such defect or for any other reason, such initial failure to reject in no way prevents the later rejection when such defect is discovered, or obligates the County to final acceptance. The County is not responsible for losses suffered due to any necessary removals or repairs of such defects.
- 3. Failure to Remove and Renew Defective Materials and Work: If Contractor fails or refuses to remove and renew any defective materials used or work performed, or to make any necessary repairs in an acceptable manner and in accordance with the requirements of the Contract within the time indicated in writing, the Engineer has the authority to repair, remove, or renew the unacceptable or defective materials or work as necessary, all at Contractor's expense. The Department will obtain payment for any expense it incurs in making these repairs, removals, or renewals, that Contractor fails or refuses to make, by deducting such expenses from any moneys due or which may become due Contractor, or by charging such amounts against the Contract bond.
- 4. Inspection by State and/or Federal Government: When the State of Florida and/or the United States Government pays a portion of the cost of construction, their representatives may inspect the construction work as they deem necessary. However, such inspection(s) will in no way make the State or the Federal Government a party to the Contract.

N. Final Inspection

- 1. Maintenance until Acceptance: Maintain all Work until Engineer has given final acceptance in accordance with the requirements of the Contract Documents.
- 2. Inspection for Acceptance:
  - a. Upon notification that all Contract Work, or all Contract Work on the portion of the Contract scheduled for acceptance, has been completed, Engineer will make an inspection for acceptance. The inspection will be made within seven days of the notification. If Engineer finds that all work has been satisfactorily completed, the Department will

consider such inspection as the final inspection. If any or all of the Work is found to be unsatisfactory, Engineer will detail the remedial work required to achieve acceptance. Immediately perform such remedial work. Subsequent inspections will be made on the remedial work until Engineer accepts all Work.

- b. Upon satisfactory completion of the Work, the Department will provide written notice of acceptance, either partial or final, to Contractor.
  - c. Until final acceptance in accordance with the requirements of the Contract Documents, replace or repair any damage to the accepted Work.
3. Partial Acceptance: At Engineer's sole discretion, Engineer may accept any portion of the Work under the provisions stipulated above.
4. Conditional Acceptance: Engineer will not make, or consider requests for conditional acceptance of a project.
- O. Final Acceptance.
- a. When, upon completion of the final construction inspection of the entire Project, Engineer determines that Contractor has satisfactorily completed all the Work and furnished all documents required by the Contract Documents, Engineer will give Contractor written notice of final acceptance. Final Acceptance shall also denote the beginning of any warranty periods associated with the Project.

#### 1.04 CONTROLLING MATERIALS

##### A. Acceptance Criteria

##### 1. General:

- a. All materials and equipment, except for materials specifically called for on the Contract Documents to be provided by the County, are to be supplied by the Contractor who must, as required, obtain shop drawing approvals and order these items in a timely fashion so as not to cause any delays in the approved schedule.
- b. Acceptance of materials is based on the criteria provided herein and elsewhere in the Contract Documents. All requirements may not apply to all materials. Use only materials in the Work that meet the requirements of the Contract Documents. Engineer may inspect and test any material, at points of production, distribution and use.

##### 2. Sampling and Testing:

- a. Use sample identification and tracking forms approved by Engineer to provide related information and attach the information to

each sample. Restore immediately any site from which material has been removed for sampling purposes to the pre-sampled condition with materials and construction methods used in the initial construction, at no additional cost to the County. Ensure that sufficient material is delivered to allow for proper sample collection, at no expense to the County.

##### b. Where required:

- 1) Pretest by Manufacturers: Submit certified manufacturer's test results to Engineer for qualification and use on the Project. Testing will be as specified in the Contract Documents. The Department may require submittal from manufacturers of samples of materials for independent verification purposes.
- 2) Point of Production Test: Test the material during production as specified in the Contract Documents.
- 3) Point of Distribution Test: Test the material at Distribution facilities as specified in the Contract Documents.
- 4) Point of Use Test: Test the material immediately following placement as specified in the Contract Documents. After delivery to the Project, the Department may require the retesting of materials that have been tested and accepted at the source of supply, or may require the testing of materials that are to be accepted by Producer Certification. The Department may reject all materials that, when retested, do not meet the requirements of the Contract Documents.

##### 3. Certification:

- a. Manufacturer Material Certification: Submit material certifications for all materials to Engineer for approval when required by the Specifications. Materials will not be considered for payment when not accompanied by a material certification. Sample material certification forms are available on the FDOT's website at the following URL: <http://www.fdot.gov/materials/navigation/documents.shtm>
- b. Ensure that the material certification follows the format of the sample form, is submitted on the manufacturer's letterhead and is signed by a legally responsible person employed by the manufacturer.
- c. FDOT Approved Product List (APL): The Department will limit Contractor's use of products and materials that require use of APL items to those listed on the APL effective at the time of placement.
- d. Traffic Signals and Signs (TSS) Division's Qualified Products List (TSSQPL):



- 1) Only those traffic control equipment and materials listed in the DTPW Traffic Signals and Signs (TSS) Division's Qualified Products List (TSSQPL), or submitted to and approved in writing by the DTPW TSS for addition to the TSSQPL, are allowed to be installed within Miami-Dade County. Equipment or material used in the performance of the Work, without prior Departmental approval, must be replaced with Department approved equipment or material, at no cost to the County. The TSSQPL is available at <http://www.miamidade.gov/qpl/Home.aspx>
  - e. Contractor Installation Certification: Provide installation certifications as required by the Contract Documents.
- B. Applicable Documented Authorities Other Than Specifications
1. General: Details on individual materials are identified in various material specific Sections of the Specifications that may refer to other documented authorities for requirements. When specified, meet the requirements as defined in such references.
  2. Test Methods: Methods of sampling and testing materials are in accordance with the Florida Methods (FM). If a Florida Method does not exist for a particular test, perform the testing in accordance with the method specified in the Specification. When test methods or other standards are referenced in the Specifications without identification of the specific time of issuance, use the most current issuance, including interims or addendums thereto, at the time of bid opening.
  3. Construction Aggregates:
    - a. Unless otherwise specified in the Contract Documents:
      - 1) All aggregate products and sources used in performance of the Work must be approved by FDOT pursuant to Rule 14-103, F.A.C. Aggregates and sources used must be identified in the FDOT "Approved Aggregate Products from Mines or Terminals" listings current at the time the aggregate is proposed for use on the Project.
      - 2) Each truck aggregate load ticket provided must include the DTPW Project Name and Number, name of the aggregate source, the FDOT Source Number, quantity, aggregate description and corresponding FDOT material code, producer ticket number, and statement "CERTIFIED FOR FDOT" or "CERT. FOR FDOT."
- C. Storage of Materials and Samples
1. Method of Storage: Store materials in such a manner as to preserve their quality and fitness for the work, to facilitate prompt inspection, and to minimize noise impacts on sensitive receivers. More detailed requirements concerning the storage of specific materials are prescribed under the applicable Specifications. The Department may reject improperly stored materials.
2. Use of Right-of-Way for Storage: Unless otherwise stated in the Contract Documents, no Project staging areas have been provided by the County. If Engineer allows, Contractor may use a portion of the right-of-way for temporary storage purposes and for temporarily placing Contractor's plant and equipment. Use only the portion of the right-of-way that is outside the clear zone, which is the portion not required for public vehicular or pedestrian travel. When used, restore the right-of-way to pre-construction condition at no additional cost to the County or as specified in the Contract Documents. Provide any additional space required at no expense to the County.
3. Responsibility for Stored Materials: Accept responsibility for the protection of stored materials. The Department is not liable for any loss of materials, by theft or otherwise, or for any damage to the stored materials.
4. Storage Facilities for Samples: Provide facilities for storage of samples as described in the Contract Documents and warranted by the test methods and Specifications.
- D. Defective Materials
1. Materials not meeting the requirements of the Contract Documents will be considered defective. Engineer will reject all such materials, whether in place or not. Remove all rejected material immediately from the site of the work and from storage areas, at no expense to the County.
  2. Do not use material that has been rejected and the defects corrected, until Engineer has approved the material's use. Upon failure to comply promptly with any order of Engineer made under these provisions, Engineer will remove and replace defective material and deduct the cost of removal and replacement from any moneys due or to become due to Contractor.
  3. As an exception to the above, Contractor may submit, upon approval of Engineer, an engineering and/or laboratory analysis to evaluate the effect of defective in-place materials. A Specialty Engineer, who is an independent consultant or Contractor's Engineer of Record as stated within each individual Section shall perform any such analysis. Engineer will determine the final disposition of the material after review of the information submitted by Contractor. No additional monetary compensation or time extension will be granted for the impact of any such analysis or review.
- E. Products and Source of Supply
1. Source of Supply—Convict Labor (Federal-Aid Contracts Only):
    - a. Do not use materials that were produced after July 1, 1991, by convict labor for Federal-aid highway construction projects

unless the prison facility has been producing convict-made materials for Federal-aid highway construction projects before July 1, 1987.

- b. Use materials that were produced prior to July 2, 1991, by convicts on Federal-aid highway construction projects free from the restrictions placed on the use of these materials by 23 U.S.C. 114. The Department will limit the use of materials produced by convict labor for use in Federal-aid highway construction projects to:
    - 1) Materials produced by convicts on parole, supervised release, or probation from a prison or,
    - 2) Materials produced in a qualified prison facility.
  - c. The amount of such materials produced for Federal-aid highway construction during any 12-month period shall not exceed the amount produced in such facility for use in such construction during the 12-month period ending July 1, 1987.
2. Buy American: Contractor must comply with the requirements of Miami Dade County Code, Section 2-8.2.6.1, Buy American Iron and Steel Products Procurement Program:
- a. The Buy American legislation requires that iron and steel products utilized in certain Miami-Dade County public improvement projects be produced in the United States. This requirement shall not apply if:
    - 1) The project is federal funded.
    - 2) iron and steel products are not produced in the United States in sufficient and reasonably available quantities or of a satisfactory quality; or
    - 3) upon a written recommendation of the County Mayor approved by a majority vote of the Board members present, compliance with this requirement is not consistent with the best interests of the public.
3. Source of Supply-Steel (Federal-Aid Contracts Only):
- a. Use steel and iron manufactured in the United States, in accordance with the Buy America provisions of 23 CFR 635.410, as amended. Ensure that all manufacturing processes for this material occur in the United States. As used in this specification, a manufacturing process is any process that modifies the chemical content, physical shape or size, or final finish of a product, beginning with the initial melting and continuing through the final shaping and coating. If a steel or iron product is taken outside the United States for any manufacturing process, it becomes foreign source material. When using steel or iron materials as a component of any prestressed beams, corrugated steel pipe, etc.), these

same provisions apply manufactured product (e.g., concrete pipe. Foreign steel and iron may be used when the total actual cost of such foreign materials does not exceed 0.1% of the total Contract amount or \$2,500, whichever is greater.

- b. These requirements are applicable to all steel and iron materials incorporated into the finished work, but are not applicable to steel and iron items that the Contractor uses but does not incorporate into the finished work. Submit certification from the manufacturer of steel or iron, or any product containing steel or iron, stating that all steel or iron furnished or incorporated into the furnished product was produced and manufactured in the United States or a statement that the product was produced within the United States except for minimal quantities of foreign steel and iron valued at \$ Submit (actual cost). each such certification to the Engineer prior to incorporating the material or product into the project. Prior to the use of foreign steel or iron materials on a project, document the actual cost of such material submit invoices to, and obtain the Engineer's written approval prior to incorporating the material into the project.

4. Contaminated Unfit, Hazardous, and Dangerous Materials:

- a. Do not use any material that, after approval and/or placement, has in any way become unfit for use.
- b. Do not use materials containing any substance that has been determined to be hazardous by the State of Florida Department of Environmental Protection or the U.S. Environmental Protection Agency (EPA). Provide workplaces free from serious recognized hazards and to comply with occupational safety and health standards, as determined by the U.S. Department of Labor Occupational Safety and Health Administration (OSHA).

1.05 LEGAL REQUIREMENTS AND RESPONSIBILITY TO THE PUBLIC

A. Disaster Preparedness

1. General:

- a. During periods in which any portion of Miami-Dade County is designated by the National Oceanic and Atmospheric Administration's National Hurricane Center as being under a Tropical Storm Watch or greater, Contractor shall perform all precautions as necessary to safeguard the Work and property, including the removal of all small equipment and materials from the site, securing all other equipment and materials to each other and to rigid construction, and any other safety measures as may be directed by Engineer.

2. Upon Notification of a Tropical Storm or Hurricane Watch:

- a. Engineer will provide formal notification to Contractor to prepare and submit for approval a Plan of Action for the specific actions to be taken on their particular projects.

3. Upon Notification of a Tropical Storm or Hurricane Warning:

- a. Engineer will provide formal notification to Contractor to implement the approved Plan of Action to protect the Project and the public.
- b. For construction projects within the public right-of-way, Contractor will be notified by Engineer to suspend his construction operations. Contractor will backfill all open trenches, remove all construction equipment and materials from the right-of-way, remove unnecessary traffic barricades and signs, and secure remaining barricades by "half burial" or "double sand bags."

4. Storm or Disaster Services:

- a. Contractor, by accepting the award of this Contract, recognizes and agrees that should a storm or other severe and catastrophic natural disaster affect the Miami-Dade-County area during the performance of the work, Contractor shall provide services contracted for during the contract period, at the Contract unit prices and at the same or different locations from those covered by this Contract.
- b. For emergency services and conditions not addressed by this Contract, Contractor agrees to negotiate reasonable prices and terms with the County for any disaster-relief work required by the County. In all instances, Contractor agrees to negotiate reasonable time extensions for performance of disaster-relief work.

B. Laws to be Observed

1. General:

- a. Become familiar with and comply with all applicable Federal, State, County, and city laws, by-laws, ordinances, and regulations that control the action or operation of those engaged or employed in the Work or that affect materials used. Pay particular attention to the applicable safety regulations promulgated by the U.S. Department of Labor, Occupational Safety and Health Administration (OSHA). In addition, comply with Chapter 403, F.S. (Florida Statutes), regarding control of air pollution. Direct special attention to that portion of Chapter 17-5, F.A.C. (Florida Administrative Code), pertaining to open burning in land clearing operations. Where work or structures included in the Contract are in "Navigable

Waters of the U.S.," (reference 33 of the Code of Federal Regulations, Part 329); "Waters of the U.S.," (reference 33 of the Code of Federal Regulations, Parts 323 and 328); or "Waters of the State," (reference Part 4, Chapters 253 and 373 of the Florida Statutes and Section 62-340, F.A.C.); comply with the regulatory provisions of Section 404 of the Federal Clean Water Act of 1977; Sections 9 and 10 of the Federal River and Harbor Act of 1899; Chapter 161, F.S.; and any local authority having jurisdiction over such waters.

- b. Obtain certification from the Construction Industry Licensing Board as required by Part I, Chapter 489, F.S., regardless of exemptions allowed by Section 489.103, F.S., prior to removing underground pollutant storage tanks. Dispose of tanks and pollutants in accordance with the requirements and regulations of any Federal, State, or local, agency having jurisdiction.
- c. Prior to building construction or renovation, provide copies of current registrations or certifications issued by the Florida Construction Industry Licensing Board in accordance with Chapter 489, F.S. for the appropriate category of construction.
- d. Corporations must be registered with the State of Florida, Department of State, Division of Corporations, and hold a current State Corporate Charter Number in accordance with Chapter 607, F.S.
- e. Contractor or the authorized subcontractor applying any roofing material must be licensed or be an approved dealer and applicator of the proposed roofing material.
- f. Indemnify, defend, and save harmless the County and all of its officers, agents, and employees, in the amount of the Contract price, against all claims or liability arising from or based on the violation of any such laws, by-laws, ordinances, regulations, order, or decrees; whether by himself or his employees.

- 2. Plant Quarantine Regulations: The U.S. Department of Agriculture and the Florida Department of Agriculture and Consumer Services have issued quarantine regulations pertaining to control of the nematodes of citrus, Rule 5B-44, Florida Administrative Code, and other plant pests. Contact the local (or other available) representatives of the Animal and Plant Health Inspection Service of the U.S. Department of Agriculture, and the Division of Plant Industry of the Florida Department of Agriculture and Consumer Services to ascertain all current restrictions regarding plant pests that are imposed by these agencies. Keep advised of current quarantine boundary lines throughout the construction period.

- a. These restrictions may affect operations in connection with such items as clearing and grubbing, earthwork, grassing and mulching, sodding, landscaping, and other items which

might involve the movement of materials containing plant pests across quarantine lines.

- b. Obtain quarantine regulations and related information from the following:

Animal and Plant Health Inspection Service  
U.S. Department of Agriculture  
3029 Lake Alfred Road  
Winter Haven, Florida 33881

Director, Division of Plant Industry  
Florida Department of Agriculture and Consumer Services  
Post Office Box 147100  
Gainesville, Florida 32614-7100

3. Introduction or Release of Prohibited Aquatic Plants, Plant Pests, or Noxious Weeds:

- a. Do not introduce or release prohibited aquatic plants, plant pests, or noxious weeds into the project limits as a result of clearing and grubbing, earthwork, grassing and mulching, sodding, landscaping, or other such activities. Immediately notify Engineer upon discovery of all prohibited aquatic plants, plant pests, or noxious weeds within the project limits. Do not move prohibited aquatic plants, plant pests, or noxious weeds within the project limits or to locations outside of the project limits without Engineer's permission. Maintain all borrow material brought onto the project site free of prohibited aquatic plants, plant pests, noxious weeds, and their reproductive parts. Refer to Rule 16C-52 and Rule 5B-57, F.A.C. for the definition of prohibited aquatic plants, plant pests, and noxious weeds.
- b. Furnish Engineer, prior to incorporation into the Project, with a certification from the Florida Department of Agriculture and Consumer Services, Division of Plant Industry, stating that the sod, hay, straw, and mulch materials are free of noxious weeds, including Tropical Soda Apple.

4. Compliance with Federal Endangered Species Act and other Wildlife Regulations:

- a. The Federal Endangered Species Act requires that the Department investigate the potential impact to a threatened or endangered species prior to initiating an activity performed in conjunction with a highway construction project. If the Department's investigation determines that there is a potential impact to a protected, threatened or an endangered species, the Department will conduct an evaluation to determine what measures may be necessary to mitigate such impact. When mitigation measures and/or special conditions are necessary, these measures and conditions will be addressed in the Contract Documents or in permits as identified in 7-2.1.

- b. In addition, in cases where certain protected, threatened or endangered species are found or appear within close proximity to the project boundaries, the Department has established guidelines that will apply when interaction with certain species occurs, absent of any special mitigation measures or permit conditions otherwise identified for the project. These guidelines are posted at the following URL address:  
[https://fdotwww.blob.core.windows.net/sitefinity/docs/defaultsource/programmanagement/implemented/urlinspecs/files/endangeredwildlifeguidelines.pdf?sfvrsn=e27baf3f\\_2](https://fdotwww.blob.core.windows.net/sitefinity/docs/defaultsource/programmanagement/implemented/urlinspecs/files/endangeredwildlifeguidelines.pdf?sfvrsn=e27baf3f_2).

Take responsibility to obtain this information and take all actions and precautions necessary to comply with the conditions of these guidelines during all project activities.

- c. Prior to establishing any off-project activity in conjunction with a project, notify the Engineer of the proposed activity. Covered activities include but are not necessarily limited to borrow pits, concrete or asphalt plant sites, disposal sites, field offices, and material or equipment storage sites. Include in the notification the Financial Project ID, a description of the activity, the location of the site by township, range, section, county, and city, a site location map including the access route, the name of the property owner, and a person to contact to arrange a site inspection. Submit this notification at least 30 days in advance of planned commencement of the off-site activity, to allow for the Department to conduct an investigation without delaying job progress.
- d. Do not perform any off-project activity without obtaining written clearance from the Engineer. In the event the Department's investigation determines a potential impact to a protected, threatened or endangered species and mitigation measures or permits are necessary, coordinate with the appropriate resource agencies for clearance, obtain permits and perform mitigation measures as necessary. Immediately notify the Engineer in writing of the results of this coordination with the appropriate resource agencies. Additional compensation or time will not be allowed for permitting or mitigation, associated with Contractor initiated off-project activities.

5. Occupational Safety and Health Requirements: Contractor shall take all precautions necessary for the protection of life, health, and general occupational welfare of all persons, including employees of both Contractor and the County, until Contractor has completed the work required under the Contract. Comply at all times with applicable Federal, State, and local laws, provisions, and policies governing safety and health, including 29 CFR 1926, including all subsequent revisions and updates.

6. Discovery of an Unmarked Human Burial: When an unmarked human burial is discovered, immediately cease all activity that may disturb the unmarked human burial and notify Engineer. Do not resume activity until specifically authorized by Engineer.
7. Insecticides and Herbicides: Use products approved by the Florida Department of Agriculture for the State of Florida, found on the following website <http://state.ceris.purdue.edu/>. The use of restricted products is prohibited. Do not use any products in the sulfonyleurea family of chemicals. Herbicide application by broadcast spraying is not allowed.
  - a. Procure any necessary licenses, pay all charges and fees, and give all notices necessary for lawful performance of the work.
  - b. Ensure that all employees applying insecticides and herbicides possess a current Florida Department of Agriculture Commercial Applicator license with the categories of licensure in Right-of-Way Pest Control and Aquatic Pest Control. Provide a copy of current certificates upon request, to Engineer.
  - c. Ensure that employees who work with herbicides comply with all applicable Federal, State, and local regulations.
  - d. Comply with all regulations and permits issued by any regulatory agency within whose jurisdiction work is being performed. Post all permit placards in a protected, conspicuous location at the work site.
  - e. Acquire any permits required for work performed on the rights-of-way within the jurisdiction of National Forests in Florida. Contact the Local National Forest Ranger District, or the United States Department of Agriculture (USDA) office for the proper permits and subsequent approval.
  - f. Acquire all permits required for aquatic plant control as outlined in Chapter 62C-20, F.A.C., Rules of the Florida Department of Environmental Protection. Contact the Regional Field Office of Bureau of Invasive Plant Management of the Florida Department of Environmental Protection for proper permits and subsequent approval. If application of synthetic organo-auxin herbicides is necessary, meet the requirements of Chapter 5E-2, F.A.C.
  - g. Fertilizer: Ensure that all employees applying fertilizer, possess a current Florida Department of Agriculture and Consumer Services Commercial Applicator license in accordance with Section 482.1562, F.S. Upon request, submit the current certificates to the Engineer.
8. Compliance with Section 4(f) of the USDOT Act: (Staging Areas)
  - a. Section 4(f) of the USDOT Act prohibits the U. S. Secretary of Transportation from approving a project which requires the use of publicly owned land of a public park, recreation area or a wildlife and waterfowl refuge, or of any historic site of national, state, or local significance unless there is no prudent or feasible alternative to using that land and the program or project includes all possible planning to minimize the harm to the site resulting from the use.
  - b. Before undertaking any off-project activity associated with any federally assisted undertaking, ensure that the proposed site does not represent a public park, recreation area, wildlife or waterfowl refuge, or a historic site (according to the results of the Cultural Resources Survey discussed under FDOT 120-6.2). If such a site is proposed, notify the Engineer and provide a description of the proposed off-site activity, the location of the site by township, range, section, a county or city map showing the site location, including the access route and the name of the property. It is the Contractor's responsibility to submit justification for use of Section 4(f) property that is sufficient for the Florida Department of Transportation and the Federal Highway Administration to make a Section 4(f) determination. Submit this notification sufficiently in advance of planned commencement of the off-site activity to allow a reasonable time for the Engineer to conduct an investigation without delaying job progress. Do not begin any off-project activity without obtaining written clearance from the Engineer
9. Employment Eligibility Verification
  - a. By entering into this Contract, the Contractor affirms its enrollment and participation in the Federal work authorization program known as "E-Verify", web address <https://www.e-verify.gov/> operated by the United States Citizenship and Immigration Services Bureau of the United States Department of Homeland Security, to verify information under the terms governing use of the system.
  - b. The Contractor shall utilize the U.S. Department of Homeland Security's E-Verify system and retain the I-9 Forms for inspection, in accordance with the terms governing use of the system, to confirm the employment eligibility of all persons employed by the Contractor during the term of the Contract to perform employment duties within Florida; and all persons, including subcontractors, assigned by the Contractor to perform work pursuant to the Contract.
  - c. Contractor shall also be responsible for entering into an agreement, with each and every vendor and subcontractor, that states that the vendor or subcontractor (and their vendors) is independently responsible for its own employment decisions, including hiring, disciplinary and termination decisions; and is participating in the "E-Verify" program to confirm, under the terms governing use of the system, the employment eligibility of all

persons assigned to perform work or provide materials and services in support of this Contract.

- d. As per Florida Statute, Section 448.095, title "Verification of Employment Eligibility," Contractor and all Subcontractors must provide an affidavit attesting that the Subcontractor does not employ, contract with, or subcontract with, an unauthorized alien. Failure to comply may lead to termination of this contract, or if a Subcontractor knowingly violates the statute, the subcontract must be terminated immediately. Any challenge to termination under this provision must be filed in the Circuit Court no later than twenty (20) calendar days after the date of termination. If this Contract is terminated for a violation of the statute by the Contractor, the Contractor may not be awarded a public contract for a period of one year after the date of termination, and the Contractor may be liable for any additional costs incurred by the County resulting from the termination of the Contract
- e. Miami-Dade County reserves the right, at any time, to request supporting documentation, as evidence of services provided and demonstration of compliance with the above requirements.

### C. Permits and Licenses

#### 1. General:

- a. Except for permits procured by the Department, as incorporated by Special Provision to this Contract, if any, procure all permits and licenses, pay all charges and fees, and give all notices necessary and incidental to the due and lawful prosecution of the Work.
- b. The Department will also acquire any modifications or revisions to an original permit incorporated by Special Provision to this Contract when Contractor requires such modifications or revisions to complete the construction operations specified in the Plans or Special Provisions and within the right-of-way limits.
- c. Contractor must obtain all other permits required for this Project prior to commencing the Work. This includes permits required by other municipalities and agencies, permits to work in the Right-of-Way, and those required for the removal or relocation of trees.
- d. The actual amount paid for the permits will be reimbursed to Contractor from a dedicated allowance established by the County. If no dedicated allowance is specified the reimbursement shall be paid from the Contract's Contingency Allowance. Original receipts must be presented to Engineer for approval.

- e. Contractor must give all notices, pay all fees and comply with all laws, rules and regulations applicable to the Work at no additional cost.
- f. Acquire all permits for work performed outside the right-of-way or easements for the Project.
- g. In carrying out the work in the Contract, when under the jurisdiction of any environmental regulatory agency, comply with all regulations issued by such agencies and with all general, special, and particular conditions relating to construction activities of all permits issued to the Department as though such conditions were issued to Contractor. Post all permit placards in a protected location at the worksite.
- h. In case of a discrepancy between any permit condition and other Contract Documents, the more stringent condition shall prevail.

#### 2. Additional Contractor Requirements For Work With Traffic Control Devices or Street Lighting

- a. In addition to the license(s) required of Contractor, all personnel engaged in installing, modifying, repairing, removing or maintaining: roadway street lighting systems; traffic signalization; or any other electrical/electronic traffic control device in Miami-Dade County must:
  - 1) Perform work under the direction of a Master Electrician that is present at the job site or able to respond within 2 hours of notification (4 hours for roadway street lighting systems).
  - 2) Perform all work under the direct supervision of a Journeyman Electrician. For Traffic Signalization or Control Devices the Journeyman Electrician must be certified as an International Municipal Signal Association (IMSA) certified Traffic Signal Technician (TST) Level II or Level III. All work related to or pertaining to the controller must be performed by an IMSA certified TST Level II (Field).
  - 3) Have in their possession a wallet size card or a photocopy of their certifications and licenses. Failure to provide said documents will be cause for removal of employee from the work site, issuance of citations, and shutdown of the Work by the County.
- b. At the Preconstruction Conference, provide Engineer and the DTPW, Traffic Signal & Signs Division (7100 NW 36 Street, Miami, FL 33166) a signed affidavit affirming that the personnel performing the work described herein have all proper and valid licenses and certifications (County, State, Private or other Government Agency) required to perform the Work. Attach a list of employees assigned to this Project with a description of their duties and include copies of all of the required licenses and certifications for the Contractor

and personnel performing the Work. Changes to authorized personnel must be approved by the Engineer.

- c. Provide copies of renewed licenses and certifications prior to their expiration.
3. Work or Structures in Navigable Waters of the U.S., Waters of the U.S., and Waters of the State:
- a. In general, one or more governmental agencies will exercise regulatory authority over work or structures, including related construction operations, in all tidal areas (Channelward of the mean high water lines); in the ocean and gulf waters to the outer limits of the continental shelf; in all rivers, streams, and lakes to the ordinary high water line; in marshes and shallows that are periodically inundated and normally characterized by aquatic vegetation capable of growth and reproduction; in all artificially created channels and canals used for recreational, navigational, or other purposes that are connected to navigable waters; and in all tributaries of navigable waters up to their headwaters.
  - b. Whenever the work under or incidental to the Contract requires structures or dredge/fill/construction activities in "Navigable Waters of the U.S.," "Waters of the U.S.," and "Waters of the State," the Federal, State, county, and local regulatory agencies may require the Department to obtain a permit. For such dredge/fill /construction specified in the plans to be accomplished within the limits of the project, or for any dredge/fill/construction within the limits of Department-furnished borrow areas, the Department will procure the necessary permits prior to advertising for bids.

D. Patented Devices, Materials and Processes

1. Include all royalties and costs arising from patents, trademarks, and copyrights, in any way involved in the work in the Contract price. Whenever using any design, device, material, or process covered by letters patent or copyright, obtain the right for such use by suitable legal agreement with the patentee or owner of the copyright. File a copy of such agreement with Engineer. However, whether or not such agreement is made or filed as noted, Contractor and the surety in all cases shall indemnify, defend, and save harmless, the County from all claims for infringement by reason of the use of any such patented design, device, material, or process on work under the Contract, and shall indemnify the County for all costs, expenses, and damages that it may be obliged to pay by reason of any such infringement, at any time during the prosecution or after the completion of the Work.

E. Right-of-Way Furnished by the Department

1. Except as otherwise stipulated in these Specifications or as shown in the Plans, the Department will furnish

all rights-of-way necessary for the proper completion of the Work at no expense to Contractor.

F. Sanitary Provisions

1. Contractor shall provide and maintain, in a neat and sanitary condition, such accommodations for the use of his employees as are necessary to comply with the requirements and regulations of the State and local boards of health. Commit no public nuisance.

G. Control of Contractor's Equipment

1. Traffic Interference: Do not allow equipment, while it is on or traversing a road or street, to unreasonably interfere with traffic.
2. Overloaded Equipment: Do not operate on any road or street any hauling unit or equipment loaded in excess of (1) the maximum weights specified in the Florida Uniform Traffic Control Law, or (2) lower weights legally established for any section of road or bridge by the State, the Department, or local authorities. The governmental unit having jurisdiction over a particular road or bridge may provide exceptions by special permit under the provisions provided below for Crossings. This restriction applies to all roads and bridges inside and outside the Contract limits as long as these roads and bridges are open for public use. Contractor may overload roads and bridges which are to be demolished after they are permanently closed to the public. Contractor is responsible for all loss or damages resulting from equipment operated on a structure permanently closed to the public.
3. Crossings: Where it is necessary to cross an existing road or street, including specifically the existing traveled lanes of a divided highway within the limits of the Project, obtain permits from the Municipality, the Department or FDOT depending on the location, for crossing overloaded or oversized equipment. Cross existing roads or streets only at Engineer-designated points. Engineer may require Contractor to protect the pavement or Roadway at the crossing by using lumber, planks, or fill. Provide flagging and watchman service, or approved signal devices, for the protection of traffic at all such crossings, in accordance with an approved written plan for that activity.
4. Protection from Damage by Tractor-Type Equipment: Take positive measures to ensure that tractor-type equipment does not damage the road. If any such damage should occur, repair it without delay, at no expense to the County and subject to Engineer's approval.

H. Contractor's Equipment on Bridge Structures

1. The Specialty Engineer shall determine the effect that equipment loads have on the bridge structure and develop the procedures for using the loaded equipment without exceeding the structure's design load capacity.
2. A completed bridge structure is a bridge structure in which all elemental components comprising the load

carrying assembly have been completed, assembled, and connected in their final position. The components to be considered shall also include any related members transferring load to any bridge structure.

3. The Specialty Engineer shall analyze the effect of imposed loads on bridge structures, within the limits of a construction contract, resulting from the following operations:

- a. Overloaded Equipment as defined above operating on or crossing over completed or partially completed bridge structures.
- b. Equipment within legal load limits operating on or crossing over partially completed bridge structures.
- c. Construction cranes operating on completed or partially completed bridge structures.

4. Submit to the Department for approval three copies of design calculations, layout drawings, and erection drawings showing how the equipment is to be used so that the bridge structure will not be overstressed. The Specialty Engineer shall sign and seal one set of the three copies of the drawings and the cover sheet of one of the three copies of the calculations for the Department's Record Set.

5. Any pipe culvert(s) or box culvert(s) qualifying as a bridge by definition is excluded from the requirements above.

6. Posting of the Legal Gross Vehicular Weight: Display the maximum legal gross weight, as specified in the Florida Uniform Traffic Code, in a permanent manner on each side of any dump truck or dump type tractor-trailer unit hauling embankment material, construction aggregates, road base material, or hot bituminous mixture to the project over any public road or street. Display the weight in a location clearly visible to the scale operator, in numbers that contrast in color with the background and that are readily visible and readable from a distance of 50 feet.

#### I. Structures over Navigable Waters

1. Compliance with Federal and Other Regulations:

- a. Where erecting structures in, adjacent to, or over, navigable waters, observe all regulations and instructions of Federal and other authorities having control over such waters. Do not obstruct navigation channels without permission from the proper authority, and provide and maintain navigation lights and signals in accordance with the Federal requirements for the protection of the structure, of false work, and of navigation.
- b. In the event of accidental blocking of the navigation channel, immediately notify the U.S. Coast Guard of the blockage and upon removal of the blockage.
- c. When work platforms are indicated in the permit for construction, submit work platform construction plans to the appropriate Coast Guard District for approval. Obtain approval

prior to beginning construction on the platform.

2. Maintenance of Channel: Where the work includes the excavation of a channel or other underwater areas to a required section, maintain the section from shoaling or other encroachment until final acceptance of the project.

#### J. Manatee Protection

1. This Subarticle applies to work in tidal waters, major canals, bodies of water where manatees have been recently spotted, or where required by any regulatory permit applicable to this Project:

- a. Instruct all personnel associated with the Project about the presence of manatees and manatee speed zones, and the need to avoid collisions with and injury to manatees. Advise all construction personnel that there are civil and criminal penalties for harming, harassing, or killing manatees which are protected under the Marine Mammal Protection Act, the Endangered Species Act, and the Florida Manatee Sanctuary Act.
- b. Operate all vessels associated with the construction project at "Idle Speed/No Wake" at all times while in the immediate area and while in water where the draft of the vessel provides less than a four-foot clearance from the bottom. All vessels will follow routes of deep water whenever possible.
- c. Properly secure and regularly monitored all siltation or turbidity barriers to avoid manatee entanglement or entrapment. Barriers must not impede manatee movement. Siltation or turbidity barriers must be made of material in which manatees cannot become entangled.
- d. All on-site project personnel are responsible for observing water-related activities for the presence of manatee(s). All in-water operations, including vessels, must be shut down if a manatee(s) comes within 50 feet of the operation. Activities will not resume until the manatee(s) has moved beyond the 50-foot radius of the project operation, or until 30 minutes elapses if the manatee(s) has not reappeared within 50 feet of the operation. Animals must not be herded away or harassed into leaving.
- e. Report any collision with or injury to a manatee immediately to the FWC Hotline at 1-888-404-3922. In addition, report collision and/or injury to the U.S. Fish and Wildlife Service in Vero Beach (1-772-562-3909), and to FWC at [ImperiledSpecies@myFWC.com](mailto:ImperiledSpecies@myFWC.com)
- f. Post, facing the water, temporary signs concerning manatees prior to and during all in-water project activities. One sign which reads "Caution: Boaters" must be posted. A second sign measuring at least 8 1/2" by 11" explaining the requirements for "Idle Speed/No Wake" and the shutdown of in-



water operations must be posted in a location prominently visible to all personnel engaged in water-related activities. Use temporary signs that have already been approved for this use by the Florida Fish and Wildlife Conservation Commission (FWC) must be used (see MyFWC.com/manatee). Questions concerning these signs can be sent to the email address listed above. Remove all signs upon completion of the Project.

- g. Comply with all manatee protection requirements of regulatory permits applicable to this Project.

K. Forest Protection

- 1. Compliance with State and Federal Regulations: In carrying out work within or adjacent to State or National forests or parks, comply with all of the regulations of the State or Federal authority having jurisdiction, governing the protection of and the carrying out of work in forests or parks, and observe all sanitary laws and regulations with respect to the performance of work in these areas. Keep the areas in an orderly condition, dispose of all refuse, and obtain permits for the construction, installation, and maintenance of any construction camps, living quarters, stores, warehouses, sanitary facilities, and other structures; all in accordance with the requirements of the forest or park official.
- 2. Prevention and Suppression of Forest Fires: Take all reasonable precautions to prevent and suppress forest fires. Require employees and subcontractors, both independently and at the request of forest officials, to do all reasonably within their power to prevent and suppress forest fires. Assist in preventing and suppressing forest fires, and make every possible effort to notify a forest official at the earliest possible moment of the location and extent of all fires. Extinguish the fire if practicable.

L. Preservation of Property

- 1. General:
  - a. Protect all geodetic monuments, horizontal or vertical, located within the limits of construction.
  - b. All street name signs shall remain in place during time of construction except those required to be relocated due to interference with actual construction. All signs relocated or damaged by Contractor during the course of the work shall be re-installed or replaced at the proper location, as soon as possible at Contractor's expense.
  - c. Prior to the removal of any traffic control signs that interfere with the construction, Contractor shall provide temporary signing or other provisions to assure a continuous flow of traffic under at least the same conditions as previously existed.

- d. All signs that are found to be unserviceable shall be reported to the Miami-Dade County, Department of Transportation and Public Works, Traffic Signals & Signs Division, at (305) 592-3580, prior to the commencement of work.

2. Contractor's Use of Streets and Roads:

- a. When hauling materials or equipment to the project over roads and bridges on the State road system, County road system, or city street system, and such use causes damage, immediately, at no expense to the County, repair such road or bridge to as good a condition as before the hauling began.
- b. The Department may modify the above requirement in accordance with any agreement Contractor might make with the governmental unit having jurisdiction over a particular road or bridge, provided that Contractor submits written evidence of such agreement to Engineer prior to commencement of the Work.
- c. The use of public streets and alleys shall be such as to provide a minimum of inconvenience to the public and to other traffic. Contractor shall so conduct his operations that he shall not close any thoroughfare nor interfere in any way with traffic on railway, highways, or on water, without the written consent of the proper authorities.
- d. Contractor must immediately remove any earth or other excavated material spilled from trucks and clean the streets to the satisfaction of the governing authority.
- e. The Department has not made any attempt to define the equipment to be used in transporting the excavated material since this may vary, however, Contractor shall abide by the following general requirements:
  - 1) Transport vehicles must be of the type(s) approved for this application by the political jurisdiction involved.
  - 2) General requirements are that the vehicles have watertight bodies that they are properly equipped and fitted with seals and covers to prohibit material spillage or draining, and that they are cleaned as often as is necessary to prevent deposit of material on roadways.
  - 3) Vehicles must be loaded within all legal weight limits and operated safely within all traffic and speed regulations.
- f. The Department will not allow the operation of equipment or hauling units of such weight as to cause damage to previously constructed elements of the project, including but not necessarily limited to bridges, drainage structures, base course, and pavement.
- g. Do not operate hauling units or equipment loaded in excess of the maximum weights

specified for Overloaded Equipment on existing pavements that are to remain in place (including pavement being resurfaced), cement-treated subgrades and bases, concrete pavement, any course of asphalt pavement, and bridges.

- h. Engineer may allow exceptions to these weight restrictions for movement of necessary equipment to and from its worksite, for hauling of offsite fabricated components to be incorporated into the Project, and for crossings as specified in the Contract Documents.

3. Protection of Existing Utility Poles:

- a. Ensure that existing utility poles are properly protected during installation of pipes and structures and must coordinate with the utility pole owner any safeguards necessary to protect the utility pole, including bracing of the pole, if necessary. All costs for protection of utility poles and any costs for the temporary bracing by the utility pole owner shall be the responsibility of Contractor and shall be considered incidental to and included in the Contract prices.

4. Traffic Signs, Signal Equipment, Highway Lighting and Guardrail:

- a. Protect all existing roadside signs, signal equipment, highway lighting and guardrail, for which permanent removal is not indicated, against damage or displacement. Whenever such signs, signal equipment, highway lighting or guardrail lie within the limits of construction, or wherever so directed by Engineer due to urgency of construction operations, take up and properly store the existing roadside signs, signal equipment, highway lighting and guardrail and subsequently reset them at their original locations or, in the case of widened pavement or roadbed, at locations designated by Engineer.
- b. If the Department determines that damage to such existing or permanent installations of traffic signs, signal equipment, highway lighting or guardrail is caused by a third party, and is not otherwise due to any fault or activities of Contractor, the Department will, with the exception of any damage resulting from vandalism, compensate Contractor for the costs associated with the repairs. Repair damage caused by vandalism at no expense to the County.

5. Operations Within Railroad Right-of-Way:

- a. Notification to the Railroad Company: Notify the superintendent of the railroad company, as shown on the Plans, and Engineer at least 72 hours before beginning any operation within the limits of the railroad right-of-way; any operation requiring movement of employees, trucks, or other equipment across the tracks of the railroad company at

other than an established public crossing; and any other work that may affect railroad operations or property.

- b. Contractor's Responsibilities: Comply with whatever requirements an authorized representative of the railroad company deems necessary in order to safeguard the railroad's property and operations. Contractor is responsible for all damages, delays, or injuries and all suits, actions, or claims brought on account of damages or injuries resulting from Contractor's operations within or adjacent to railroad company right-of-way.

- c. Watchman or Flagging Services: The railroad company will furnish protective services (i.e., watchman or flagging services) to ensure the safety of railroad operations during certain periods of the project. The Department will reimburse the railroad company for the cost thereof. Schedule work that affects railroad operations so as to minimize the need for protective services by the railroad company.

6. Utilities:

a. General:

- 1) Contact the Sunshine State One Call of Florida, Inc. at 1-800-432-4770 and other affected utility owners at least 48 hours prior to commencing any trenching or excavation work on this Project.
- 2) Make all necessary arrangements with the utility companies concerned for maintenance of their lines during the construction period. In the event that a relocation of utilities is required, but has not been accomplished prior to the effective date of the "Notice to Proceed," Contractor nevertheless must commence work under this Contract, and must schedule his work to avoid interference with the utility relocation work.
- 3) County will not be liable for any delay or added expense the Contractor experiences due to the activities of utility companies, nor shall the County be held responsible for any damages to any utilities due to any actions by Contractor.

b. Arrangements for Protection or Adjustment:

- 1) Do not commence work at points where the construction operations are adjacent to utility facilities or other property, until making arrangements with the utility facilities to protect against damage that might result in expense, loss, disruption of service, or other undue inconvenience to the public or to the owners. Contractor is solely and directly responsible to the owners and operators of such properties for all damages, injuries, expenses, losses, inconveniences, or delays caused by Contractor's operations.

- 2) The Department will make the necessary arrangements with utility owners for removal or adjustment of utilities where Engineer determines that such removal or adjustment is essential to the performance of the required construction. The Department will not consider relocation or adjustment requests based on Contractor's proposed use of a particular method of construction or a particular type of equipment as essential to the construction of the Project if Contractor could use other common methods and equipment without relocating or adjusting the utility. Engineer will determine the responsibility for any such required adjustments of utilities. Contractor shall make all requested relocations or adjustments because of delivery to the job site of Contractor-furnished materials, at no expense to the County.
- 3) The Department considers relocations and adjustments (or other protection) under the following circumstances as essential to the construction of the Project:
  - a) Utilities lying within the vertical and horizontal construction limits, plus the reasonably required working room necessary for operation of equipment normally used for the particular type of construction, all as determined by Engineer (and except as provided in paragraph (d) below). (In the case of overhead electrical conductors that carry more than 400 Volts, a minimum of 10 feet clearance between the conductor and the nearest possible approach of any part of the equipment is required, except where the utility owner effects safeguards approved by OSHA.)
  - b) Utilities lying within the horizontal limits of the project and within 12 inches below the ground surface or the excavation surface on which Contractor operates construction equipment, or within 12 inches below the bottom of any stabilizing course specified in the Plans.
  - c) Utilities lying within the normal limits of excavation for underground drainage facilities or other structures (except as provided in paragraph (d) below). Such normal limits shall extend to side slopes along the angle of repose, as established by sound engineering practice, unless the Contract Documents require support of the excavation sides by sheeting or Contractor elects to sheet such excavation for his own convenience.
  - d) Where utilities cross pipe trenches transversely within the excavation area, but not within positions from which relocation or removal is necessary, the utility owner is responsible for providing and effecting all reasonable measures for their support and protection during construction operations. Cooperate with the utility owner in the owner's effecting of such support and protective measures. Contractor is responsible for all damage to the utility that is caused by Contractor's neglect or failure to cooperate or to use proper precaution in performing his work.
- 4) In the event that a temporary relocation of a utility or a particular sequence of timing in the relocation of a utility is necessary, Engineer will direct such relocation so as to cause the least impediment to the overall construction operations. The Department is not responsible for utility adjustments or temporary relocation work, or for the conditions resulting there from, where such adjustments are:
  - a) Not necessitated by the construction of the Project,
  - b) Done solely for the benefit or convenience of the utility owner or its contractor, or Contractor where the Department considers his construction procedures to be other than normal, or
  - c) Not shown on the approved plans for the utility relocation or the construction of the Project.
  - c. Cooperation with Utility Owners:
    - 1) Cooperate with the owners of all underground or overhead utility lines in their removal and rearrangement operations in order that these operations may progress in a reasonable manner, that duplication or rearrangement work may be reduced to a minimum, and that services rendered by the utility owners will not be unnecessarily interrupted.
    - 2) In the event of interruption of water or other utility services as a result of accidental breakage, exposure, or lack of support, promptly notify the proper authority and cooperate with the authority in the prompt restoration of service. If water service is interrupted and Contractor is performing the repair work, Contractor shall work continuously until the service is restored. Do not begin work around fire hydrants until the local fire authority has approved provisions for continued service.
  - d. Utility Adjustments:
    - 1) Certain utility adjustments and reconstruction work may be underway during the progress of the Contract. If known prior to award, the Department will include in the Contract documents the utility authorities who are scheduled to perform utility work on the Project.
    - 2) Cooperate with the various utility construction crews who are maintaining utility service.

- 3) Exercise due caution when working adjacent to relocated utilities. Repair all damage to the relocated utilities resulting from his operations at no expense to the County.
  - 4) Protect utility facilities in accordance with the requirements of the Contract Documents and the owner.
- e. Weekly Meetings:
- 1) Conduct weekly meetings on the job site with all the affected utility companies and Engineer in attendance to coordinate project construction and utility relocation. Submit a list of all attendees one week in advance to Engineer for approval.
  - 2) Provide the approved Work Progress Schedule and Work Plan for the Project, as specified in the Contract Documents, to document the schedule and plan for road construction and utility adjustments.
  - 3) When utility relocations no longer affect construction activities, Contractor may discontinue the meetings with Engineer's approval.

M. Responsibility for Damages, Claims, etc.

1. Contractor to Provide Indemnification:
  - a. Contractor shall indemnify and hold harmless the County, its officers and employees from liabilities, damages, losses and costs, including, but not limited to, reasonable attorney's fees, to the extent caused by the negligence, recklessness, or intentional wrongful misconduct of Contractor and persons employed or utilized by Contractor in the performance of the construction Contract.
  - b. It is specifically agreed between the parties executing this Contract that it is not intended by any of the provisions of any part of the Contract to create in the public or any member thereof, a third party beneficiary hereunder, or to authorize anyone not a party to this Contract to maintain a suit for personal injuries or property damage pursuant to the terms or provisions of this Contract.
2. Guaranty of Payment for Claims: Contractor guaranties the payment of all just claims for materials, supplies, tools, or labor and other just claims against him or any subcontractor, in connection with the Contract. The Department's final acceptance and payment does not release Contractor's bond until all such claims are paid or released.

N. Contractor's Responsibility for Work

1. Until the Department's acceptance of the work, take charge and custody of the work, and take every necessary precaution against injury or damage to the work by the action of the elements or from any other cause whatsoever, arising either from the execution or from the nonexecution of the work. Rebuild, repair,

restore, and make good, without additional expense to the Department, all injury or damage to any portion of the work occasioned by any of the above causes before its completion and acceptance, except that in case of extensive or catastrophic damage, the Department may, at its discretion, reimburse Contractor for the repair of such damage due to unforeseeable causes beyond the control of and without the fault or negligence of Contractor, including but not restricted to Acts of God, of the public enemy, or of governmental authorities.

O. Opening Sections of Roadway to Traffic

1. Whenever any bridge or section of roadway is in an acceptable condition for travel, Engineer may direct Contractor to open it to traffic. The Department's direction to open a bridge or roadway does not constitute an acceptance of the bridge or roadway, or any part thereof, or waive any Contract provisions. Perform all necessary repairs or renewals, on any section of the roadway or bridge thus opened to traffic under instructions from Engineer, due to defective material or work or to any cause other than ordinary wear and tear, pending completion and Engineer's acceptance of the roadway or bridge, or other work, at no expense to the County.

P. Scales for Weighing Materials

1. Applicable Regulations: When determining the weight of material for payment, use scales meeting the requirements of Chapter 531, F.S., pertaining to specifications, tolerances, and regulations, as administered by the Bureau of Weights and Measures of the Florida Department of Agriculture.
2. Base for Scales: Place such scales on a substantial horizontal base to provide adequate support and rigidity and to maintain the level of the scales.
3. Protection and Maintenance: Maintain all scale parts in proper condition as to level and vertical alignment, and fully protect them against contamination by dust, dirt, and other matter that might affect their operation.

Q. Source of Forest Products

1. As required by Section 255.20, F.S., where price and quality are equal, and when available, use only timber, timber piling, or other forest products that are produced and manufactured in the State of Florida. This provision does not apply to Federal-aid projects.

R. Dust Control

1. Dust control measures are required as necessary to prevent the surface and air transport of dust from any construction activity performed under this contract. This may include but is not limited to: Pre-watering deeply before excavation; scheduling thorough and consistent watering that does not run off the site; applying best management practices in the loading, offloading, and transport of soils and miscellaneous materials; covering or otherwise stabilizing piles when

- necessary; and planning schedules so control measures are available throughout the project.
2. Ensure that excessive dust is not transported beyond the limits of construction in populated areas. Contractor may control dust for embankments or other cleared or unsurfaced areas by applying water, as directed by Engineer. When included in the Plans, install mulch, seed, sod, or temporary paving as early as practical. Control dust during the storage and handling of dusty materials by wetting, covering, or other means as approved by Engineer.
  3. When cutting through concrete, care should be exercised to prevent dust from becoming air borne. Contractor must use an engineering control such as the use of a wet saw or dust collector. Engineer shall have the final determination when in a particular circumstance this is not feasible, and the concrete must be cut dry.
  4. No separate item for dust control measures is included for payment in this Contract. Contractor must consider the cost of any dust control measures that is necessary for the proper construction of the Project as included in the Contract price for items of work for which dust control measures are required.

S. Dredging and Filling

1. Section 370.033, F.S., requires that all persons, who engage in certain dredge or fill activities in the State of Florida, obtain a certificate of registration from the Florida Department of Environmental Protection, Tallahassee, Florida 32301, and that they keep accurate logs and records of all such activities for the protection and conservation of the natural resources. Obtain details as to the application of this law from the Department of Environmental Protection and contact local regulatory agencies for additional applicable requirements.

T. Contractor's Motor Vehicle Registration

1. Provide the Department with proof that all motor vehicles operated or caused to be operated by such Contractor are registered in compliance with Chapter 320, F.S. Submit such proof of registration in the form of a notarized affidavit to the Department.
2. The Department will not make payment to Contractor until the required proof of registration is on file with the Department.

U. Compliance with FHWA 1273:

1. For federally funded projects and when required by law, comply with the provisions contained in FHWA-1273.
2. The FHWA-1273 Electronic version, dated July 5, 2022 is posted on the FDOT's website at the following URL address:  
<https://www.fhwa.dot.gov/programadmin/contracts/1273/1273.pdf>.

3. Take responsibility to obtain this information and comply with all requirements posted on this website up through five calendar days before the opening of bids.
4. If the FDOT website cannot be accessed, contact FDOT Department's Specifications Office Web Coordinator at (850) 414-4101.

a. s

1.06 PROSECUTION AND PROGRESS

A. Subletting Or Assigning The Contract

1. Do not, sell, transfer, assign or otherwise dispose of the Contract or Contracts or any portion thereof, or of the right, title, or interest therein, without written consent of the Department. If the Contractor chooses to sublet any portion of the Contract, the Contractor must provide a written request to sublet work on the Certification of Sublet Work form developed by the Department for this purpose.
2. Contractor must perform, with its own organization, contract work amounting to not less than 30 percent (or a greater percentage if specified elsewhere in the Contract Documents) of the total original contract price, excluding any specialty items designated by the County. Specialty items may be performed by subcontract and the amount of any such specialty items performed may be deducted from the total original contract price before computing the amount of work required to be performed by the contractor's own organization.
  - a. "Its own organization" is construed to include only workers employed and paid directly by the prime contractor and equipment owned or rented by the prime contractor, with or without operators. Such term does not include employees or equipment of a subcontractor, assignee, or agent of the prime contractor.
  - b. "Specialty Items" is construed to be limited to work that requires highly specialized knowledge, abilities, or equipment not ordinarily available in the type of contracting organizations qualified and expected to bid on the contract as a whole and in general are to be limited to minor components of the overall contract.
3. The contract amount, upon which the requirements set forth in this Subarticle is computed, includes the cost of material and manufactured products which are to be purchased or produced by the Contractor under the provisions of the Contract. For the purpose of meeting this requirement the Department will not consider off-site commercial production of materials and manufactured component products that the Contractor purchases, or their transportation to the project, as subcontracted work.
4. If the Contractor sublets a part of a Contract item, the Department will use only the sublet proportional cost in determining the percentage of subcontracted normal work.

5. Execute all agreements to sublet work in writing and include all pertinent provisions and requirements of the Contract. All other agreements must be in writing and reference all applicable Contract provisions. Upon request, furnish the Department with a copy of the subcontract and agreement. The subletting of work does not relieve the Contractor or the surety of their respective liabilities under the Contract.
  6. The Department recognizes a subcontractor only in the capacity of an employee or agent of the Contractor, and the Engineer may require the Contractor to remove the subcontractor as in the case of an employee.
  7. Contractor must furnish:
    - a. A competent superintendent or supervisor who is employed by its firm, has full authority to direct performance of the Work in accordance with the Contract requirements, and is in charge of all construction operations (regardless of who performs the work); and
    - b. Such other of its own organizational resources (supervision, management, and engineering services) as the Engineer determines is necessary to assure the performance of the Contract.
- B. Notice to Proceed
1. Unless otherwise agreed to by the parties, the Department may issue the Notice to Proceed (NTP) within 30 Days after all conditions for Contract execution have been met. The NTP will identify the date Contractor is to begin the construction and will start the Contract Time.
- C. Project Signs
1. Project Signs will be provided by Miami-Dade County Internal Services Department (ISD) at no cost to Contractor.
  2. The type, location, and number of signs required per each work site shall be at the discretion of Engineer.
  3. No work shall commence until the Project Signs are secured in place as directed by Engineer.
  4. Maintain and Relocate Project Signs.
    - a. Maintain and relocate Project Signs throughout the duration of the Contract, as directed by Engineer and at no additional cost to Miami-Dade County.
    - b. Install relocated Project Signs as required by Engineer. All materials and work necessary to secure, brace, mount, place, and maintain the Project Signs will be provided at Contractor's expense.
    - c. Notify Engineer immediately if at any time, during the Contract duration, a Project Sign becomes damaged, defaced, or unreadable. If Engineer determines that a replacement sign is required, Engineer will request it from ISD.
- D. Schedule Of Values
1. A Schedule of Values is required for any Stipulated (Lump) sum contract, or for major lump sum items on Unit price contracts for which Contractor requests progress payments.
  2. Upon notification of intent to Award and prior to the Notice to Proceed, submit to Engineer for review and approval, a preliminary Schedule of Values that:
    - a. Logically subdivides the Work into component parts with sufficient detail to serve as the basis for progress payments during performance of the Work and correlates to the Work Progress Schedule.
    - b. Includes quantities and prices of items for all of the Work which when added together equal either the Contract Base Award Amount for a Stipulated sum contract or the Contract Price for a major lump sum item in a Unit price contract.
    - c. Separately identifies the scope of work to be performed by any SBE-CONST utilized to satisfy any SBE-CONST goal in the Contract. In addition, payment requisitions for the scope of work of such SBE-CONST shall be accompanied by the statements of completion of the work of the SBE-CONST and shall be accompanied by appropriate documentation including invoicing and checks reflecting payment of the SBE-CONST for the previous construction draw.
  3. The Schedule of Values for a Stipulated sum contract will be acceptable to Engineer as to form and substance if it provides a reasonable allocation of the Contract Base Award Amount to component parts of the Work.
  4. When directed by Engineer, submit at least 10 days prior to the next application for progress payment, a revised or updated Schedule of Values to address any changes in the Work.
- E. Preconstruction Conference
1. A Preconstruction Conference will be held with Contractor, members of the Department and other Miami-Dade County Agencies, representative of Utility Companies, and other municipalities or contractors affected by the Work. The Department will set the time and place of this conference.
  2. Submit the following items to Engineer at the Preconstruction Conference unless otherwise noted:
    - a. Two copies of the proposed Work Progress Schedule. (Provide an updated schedule

within 5 days of each Work Order for work order contracts.)

- b. Contractor's Chain of Authority.
- c. Contractor's Emergency Telephone Numbers, during work hours, after hours, and on weekend, of Prime and MOT Contractor's Representatives.
- d. Letter naming Contractor's Superintendent and his qualifications.
- e. Letter naming Contractor's Work Site Traffic Supervisor and a copy of their respective Certification(s).
- f. Letter naming Contractor's MOT Flagmen and a copy of their training Certification(s).
- g. Maintenance of Traffic Plan: Letter outlining the Specific Maintenance of Traffic Plan or Plans that will be used during construction. If the MOT plan is noted in the Construction Plans, it will be for reference only. Contractor is responsible to provide his own MOT Plan. MOT plans must be submitted within 5 days of the date of each Work Order for work order contracts.
- h. Shop drawing submittal schedule. To be submitted within 5 days of the date of each Work Order for work contracts.
- i. List of potential subcontractors and rental agreements.
- j. Letter listing the material providers for this project, with the respective name and address; and letter certifying the compliance of the material with the project requirements.
- k. List of equipment to be utilized for construction; including make, model, year, name and description of equipment.
- l. Contractor's Erosion Control Plan (ECP) pursuant to the requirements of the Contract Documents.
- m. Lighting plan if Contractor intends to perform any night work.
- n. All other submittal requirements stipulated in the Contract Documents.

## F. Scheduling of the Work

### 1. Work Progress Schedule.

- a. Within 21 days after Contract award or at the Preconstruction Conference, whichever is earlier, submit to Engineer for approval two copies of a Work Progress Schedule for this Project. Engineer will review and respond to Contractor within 15 days of receipt.
- b. The Work progress Schedule must show the various activities of work in sufficient detail to demonstrate a reasonable and workable plan to initiate, construct, and complete all requirements of the Contract Documents within the Contract Duration and must:
  - 1) Include a projected Project completion, measured in dollars and time, on a monthly

basis or at each progress payment cutoff date.

- 2) Identify a date for substantial completion with "sufficient time" between substantial completion and end of Contract Duration for final inspections, final roadway striping if required, development of a punch list by the Engineer, completion of all punch list items by Contractor, final submittals, and any remaining site restoration activities. "Sufficient time," as it pertains solely to this requirement, means no less than 60 days unless otherwise required by the Contract Documents or approved in writing by Engineer.
- 3) Include the order and interdependence of activities and the sequence for accomplishing the Work including phased restoration of areas impacted by work.
- 4) Describe activities in sufficient detail so that the Engineer can readily identify the Work and measure the progress of each activity.
- 5) Show each activity with a beginning work date, activity duration, and a monetary value.
- 6) Include within the activities the necessary steps for procurement, fabrication, and delivery of materials, plant, and equipment.
- 7) Include the review time for shop drawings and submittals.
- 8) Include the Critical Path and milestone activities when milestones are required by the Contract Documents.
- 9) In projects with more than one phase, adequately identify each phase and its substantial completion date, and do not allow phase specific activities to span more than one phase.
- c. Submit with the Work Progress Schedule a narrative report describing current project schedule status and identifying potential delays. This report will include a description of the progress made since the previous schedule submission and objectives for the upcoming 30 calendar days. It will be submitted on 8.5 by 11 inch paper. This report shall at a minimum include the following information:
  - 1) Indicate if the Project is on schedule, ahead of schedule or behind schedule. If the Project is ahead of schedule or behind schedule, the report shall include the specific number of calendar days. If the Project is behind schedule, the report shall include a detailed recovery plan that will put the Project back on schedule.
  - 2) The report will describe the current critical path of the Project and indicate if this has changed in the last 30 calendar days. Discuss current successes or problems that

have affected either the critical path's length or have caused a shift in the critical path within the last 30 calendar days. Identify specific activities, progress, or events that may reasonably be anticipated to impact the critical path within the next 30 calendar days, either to affect its length or to shift it to an alternate path.

- 3) List all schedule logic or duration changes that have been made to the schedule since the previous submission. For each change, describe the basis for the change and specifically identify the affected activities by identification number.
  - 4) Identify any and all activities, either in progress or scheduled to occur within the following 30 days that require County participation, review, approval, etc.
  - d. Submit, with the Work Progress Schedule, clear documentation demonstrating that all necessary coordination activities with utility owners that have facilities within the limits of construction have been conducted. In addition, incorporate into the work progress schedule any utility adjustment schedules included in the Contract Documents unless the utility company and the Department mutually agree to changes to the utility schedules shown in the Contract.
  - e. Engineer will return inadequate schedules to Contractor for corrections. Resubmit a corrected schedule within 15 days from the date of Engineer's return transmittal.
  - f. Submit an updated Work Progress Schedule, for Engineer's acceptance, if there is a significant change in the planned order or duration of an activity. Engineer will review the corrected schedule and respond within 7 days of receipt.
  - g. By acceptance of the schedule, Engineer does not endorse or otherwise certify the validity or accuracy of the activity durations or sequencing of activities. Engineer will use the accepted schedule as a baseline against which to measure the progress.
  - h. If Contractor fails to finalize either the initial or a revised schedule in the time specified, Engineer will withhold all Contract payments until Engineer accepts the schedule.
2. Weekly Work Progress Meetings:
- a. Coordinate weekly meetings to discuss Contract progress with Engineer including near term scheduled activities, utility relocations, and problems and their proposed solutions.
  - b. Submit a Two-Week "Look Ahead" Planning Schedule at each weekly meeting, showing the items of work planned for the next two weeks. Develop the schedule in Bar Chart format, identifying current and planned activities and related Contract Schedule work

activities, including subcontractor work. Designate all activities that are controlling work items as determined by the currently accepted Contract Schedule.

- c. A report shall be submitted at each weekly meeting identifying schedule activity progress including actual start or finish dates achieved for any activities.

3. Prosecution of the Work.

- a. Give the Work the constant attention necessary to ensure the scheduled progress, and cooperate fully with Engineer and with other contractors at work in the vicinity.
- b. Do not commence work under the Contract until after the Department has issued the Notice to Proceed. Thereafter, commence the Work and continue all work in an expeditious manner to a conclusion acceptable to Engineer and in accordance with the approved Work Progress Schedule.
- c. All requirements of the Contract, including completion of punch list items and final deliverables, must be completed during the Contract Duration.
- d. Compliance with Time Requirements: Commence work in accordance with the approved Work Progress Schedule and provide sufficient labor, materials and equipment to complete all work as scheduled. Should Contractor fail to furnish sufficient and suitable equipment, forces, and materials, as necessary to prosecute the Work in accordance with the required schedule, Engineer may withhold all progress payments that are, or may become due, or suspend the work until Contractor corrects such deficiencies.
- e. Provisions for Convenience of Public: Schedule construction operations so as to minimize any inconvenience to adjacent businesses or residences. Where necessary, Engineer may require Contractor to first construct the work in any areas along the Project where inconveniences caused by construction operations would present a more serious handicap. In such critical locations, where there is no assurance of continuous effective prosecution of the work once the construction operations are begun, Engineer may require Contractor to delay removal of the existing (usable) facilities.
- f. The lack of equipment or unsuitability of said equipment shall not be an acceptable reason for falling behind schedule.
- g. If Contractor fails to complete all work under the Contract, within the time specified in the "Notice to Proceed" and/or Work Order(s), or fails to perform the Work with sufficient personnel and equipment or with sufficient materials to assure the prompt completion of the work assigned, or discontinues the prosecution of the Work, or fails to resume



work which has been discontinued within a reasonable time after notice to do so, or becomes insolvent or is declared bankrupt, or files for reorganization under the bankruptcy or insolvency code, or for any other cause whatsoever, fails to carry on the work in an acceptable manner, or if the surety executing the bond, becomes unsatisfactory in the opinion of the County, Engineer will give notice in writing to Contractor and his surety of such delay, neglect, or default. Additionally, the County may opt to not issue further Work orders and/or to terminate the Contract in addition to assigning a non-responsive Contractor Evaluation rating. Continuous failure by Contractor to complete work in a timely fashion may result in the County not issuing further work and/or cancellation of the Contract.

4. Additional Requirements for Work Order Contracts:

- a. The completion time for each Work Order will consist of a reasonable duration determined by Engineer.
- b. After the "Notice to Proceed" and issuance of the Work Order(s), Contractor shall commence the Work on the effective date of each Work Order and continue all work in an expeditious manner to a conclusion acceptable to Engineer.
- c. All activities required to be performed for each Work Order, including completion of punch list items and final deliverables, must be completed during the Work Order Days provided for each Work Order.
- d. Unless otherwise provided by the Contract Documents, Engineer may issue subsequent Work Order(s) any time after Engineer determines that work under an existing Work Order is substantially completed, even if site restoration or punch list items are pending for the existing Work Order.

G. Progress of the Work.

1. Unless otherwise stipulated herein, progress of the Work will be evaluated monthly and compared to the approved Work Progress Schedule.
  - a. When dollars invoiced by Contractor on the Project are 15 percent greater than the estimated dollars for the work scheduled, Engineer may request in writing, that Contractor submit a revised Work Progress Schedule for approval by the next scheduled monthly submittal date.
  - b. When the dollars earned by Contractor on the Project are 15 percent less than the estimated dollars for the work scheduled, Engineer may deem the progress of the Work unsatisfactory and will issue a notice to Contractor of unsatisfactory performance.
  - c. In the event a noncritical item becomes critical as determined by Engineer,

Contractor must submit a revised CPM schedule.

- d. When an activity on the critical path, as shown on the current approved Work Progress Schedule, has exceeded its late start date by 7 Days, Engineer will deem the progress of Work unsatisfactory and will hold a meeting with Contractor to address the schedule within 7 Days of the discovery. If a resolution cannot be determined within 5 Days, Engineer will issue a notice to Contractor of unsatisfactory performance.
- e. When it becomes apparent that an activity on the critical path, as shown on the current approved Work Progress Schedule, has exceeded its original duration by 10 or more Days, regardless of the Contract's definition of Contract Time, Contractor must submit a revised Work Progress Schedule for approval within 5 Days of the discovery and Engineer will issue a notice of unsatisfactory performance to the Contractor and identify the unsatisfactory performance.

2. The notice of unsatisfactory performance will also allow a reasonable period of time, as determined by Engineer but not to exceed 30 Days from receipt of the notice, for Contractor to bring the progress of the Work into compliance with the current accepted work progress schedule or to provide acceptable written justification for the delay. Contractor must do the following things within the time specified in the notice to Contractor of unsatisfactory performance:

- a. Submit a revised baseline progress schedule and recovery plan to Engineer for review and approval. Demonstrate the proposed method to complete the Project within the remaining time specified in the current accepted work progress schedule; and
- b. If Contractor is unable to provide such a revised schedule, a late completion schedule shall be submitted indicating the time required to complete the Work. The Department's approval of the late completion schedule will not operate as a waiver of the Department's right to assess liquidated damages;
- c. Take all necessary action, subject to Engineer's approval, to ensure completion of the Project at no additional cost to the Department within the remaining time specified in the accepted schedule. Actions may include but not be limited to the following:
  - 1) Additional overtime;
  - 2) Added work shift;
  - 3) Additional workforce;
  - 4) Extended workweek;
  - 5) Additional Equipment; or
  - 6) A combination of these.

H. Performance of Work

- 1. Give due and adequate notices to those in control of all properties that may be affected by the construction activities.
- 2. Keep on the job site sufficient plant and equipment to meet the requirements of the Work. The plant shall be kept in a satisfactory operating condition and be capable of safely and efficiently performing the Work as set forth in the Plans and Specifications. The equipment and all operations shall be subject to inspection by Engineer at all times.
- 3. Submit for approval by Engineer, a description of the type of materials and equipment to be used; and the method of procedure to be used in the performance of the Work.

4. Condition of Equipment

- a. All equipment used in the performance of the Work must be in first class operating condition, including proper mufflers and other silencing accessories. All equipment must be properly lubricated on a special maintenance type schedule to reduce noise, including tracks, rollers, idlers, sheaves and other noise producing components. Care must be taken to prevent oil spillage of any kind or oil dripping from equipment. All dewatering pumps and welding machines must be engine driven or powered by Contractor furnished generators. The temporary power source available at the jobsite is not sufficient to power that type of equipment.
- b. If the equipment used proves less than satisfactory and is unduly or needlessly disturbing the neighbors, in the opinion of Engineer, he will have the right to order Contractor to immediately modify the equipment to make it satisfactory, or to change to other equipment that is satisfactory at no additional cost to the County.

5. Saw Cutting:

- a. When required in performance of this Contract, material may be removed by either saw cutting the slab perpendicular to the long edge, or by any other means that will produce a clean neat cut and that is acceptable to Engineer. All costs for saw cutting and/or any other necessary means for accomplishing the bid items listed in this Contract shall be included in the cost for said item.

6. Open Excavations:

- a. At the close of each workday, Contractor shall refill all open excavations, or cover open excavations with steel plates capable of supporting vehicular traffic at no additional cost to the County.

7. Florida Trench Safety Act

- a. The Florida Trench Safety Act (Sections 553.60-553.64, Florida Statutes) is hereby

incorporated by reference and made a part of these Specifications. The purpose and intention of the State of Florida "Trench Safety Act" is to provide for increased worker safety by requiring compliance with sufficient standards for trench safety and providing additional specific requirements when the excavation is in excess of 5 feet deep. By executing the Contract, Contractor certifies that he is fully aware of the Trench Safety Act, and will comply with applicable trench safety standards.

- b. In accordance with Sections 553.60-553.64, F.S., the bidder acknowledges those included in the various items of the proposal and in the total bid price are costs for complying.

I. As-Built Drawings

- 1. Five (5) sets of complete "As-Built" drawings signed and sealed by either a Florida Registered Surveyor and Mapper or a Florida Registered Professional Engineer, shall be accurately recorded by Contractor and submitted to Engineer prior to final acceptance of the Work. As Built drawing required for Federally Funded Projects must be signed and sealed only by a Florida Registered Professional Engineer.
- 2. The As-Built Drawings must contain detailed information pertaining to the locations, spans, depths, and elevations of all significant elements of construction performed pursuant to the Contract Documents in addition to all information necessary to comply with Project permits and regulatory requirement.
- 3. All locations, depths, and elevations shall be taken by a Florida Registered Surveyor and Mapper and be shown on the As-Built drawings.
- 4. No separate payment will be made for the As-Built drawings.

J. Liquidated Damages

- 1. Contractor, or in case of his default the surety, shall pay to the County, not as a penalty but as liquidated damages, the amount stipulated below should Contractor fail to complete all work specified within the time stipulated in the Contract for substantial completion, including extra time granted in writing by the County. Substantial completion must be achieved 60 days prior to contract final acceptance, unless a different time is stipulated under contract duration on the Special Provisions. For Work Order based Contracts, liquidated damages shall be the amount stipulated below, computed for each Work Order, should Contractor fail to complete all work specified within the time stipulated in the Work Order, including extra time granted in writing by the County.
- 2. Applicable liquidated damages for each day after the scheduled substantial completion date are the amounts established in the following schedule:

Total Contract/Work Order Amount	Daily Charge Per Calendar Day
\$50,000 and under	\$868
Over \$50,000 but less than \$250,000	\$882
\$250,000 but less than \$500,000	\$1,197
\$500,000 but less than \$2,500,000	\$1,694
\$2,500,000 but less than \$5,000,000	\$2,592
\$5,000,000 but less than \$10,000,000	\$3,786
\$10,000,000 but less than \$15,000,000	\$4,769
\$15,000,000 but less than \$20,000,000	\$5,855
\$20,000,000 and over	\$9,214 plus 0.00005 of any amount over \$20 million (Round to nearest whole dollar)

3. Contractor, or in case of his default the surety, shall pay to the County, not as a penalty but as liquidated damages, 30% of the amount stipulated above under this Subarticle J.2 should Contractor fail to complete punch list items and deliver all required documents, including warranties, necessary to close out the project within the total time stipulated in the Contract for final acceptance, including extra time granted in writing by the County.
4. Engineer will count default days in calendar days.
5. County has the right to apply, as payment on such liquidated damages, any money the County owes Contractor.
6. County does not waive its right to liquidated damages due under the Contract by allowing Contractor to continue and to finish the work, or any part of it, after the expiration of the Contract/Work Order Time including granted time extensions.
7. The requirements of this Article may not be waived, compromised or settled without the express written consent of the Board of County Commissioners.

K. Limitations of Operations

1. General:

- a. Subject to any provision to the contrary provided in these Contract Documents, Work must not be carried out during the night or on Saturdays, Sundays or on County holidays without prior written approval from Engineer issued at least 72 hours before these times so that proper inspection and engineering services may be scheduled.
- b. Prior written approval from Engineer, as specified in this Article, is not required for the performance of work that is necessary for proper care, maintenance, and protection of Work already done, or in cases when the

Work would otherwise be endangered or when hazard to life or property would result, in which case Contractor must inform Engineer at the earliest possible opportunity of the same.

- c. All construction activities, designated by Engineer as requiring inspection by the County, must be scheduled to coincide with the hours of availability of Engineer or Engineer's duly authorized inspector. The hours of availability are from 7:00 AM until 4:30 PM Monday through Friday; unless otherwise approved by the Engineer, these construction activities must be scheduled to coincide with the aforementioned hours of availability.
- d. Work performed without the prior written approval of Engineer and without an Engineer's duly authorized inspector may be declared defective solely on the grounds that it was not properly inspected.
- e. In the event, that the Engineer approves work on night or on Saturdays, Sundays or on County holidays; the Contractor will be responsible to pay the overtime incurred during the approved overtime hours at the current inspector's hourly rate. Such payment will be deducted from the monthly invoice.
- f. Contractor must conform to all applicable laws, regulations, or ordinances with regard to labor employed, hours of work and general operations.

2. Night Work:

- a. Night work may be undertaken as a regular procedure when required by the Contract Documents or approved in writing by Engineer. Such approval, however, may be revoked at any time by Engineer if Contractor fails to maintain adequate equipment, lighting, and supervision for the proper prosecution and control of the Work at night pursuant to the requirements herein.
- b. For the purposes of this Article, the term "night" shall mean the period from 6:00 p.m. to 7:00 a.m. Due to traffic interference concerns, authorized night construction activities that may be disruptive to traffic flow can only be performed weekdays between 9:00 p.m. to 5:00 a.m.
- c. Prepare a specific work plan and submit it to the Engineer for approval at least one week in advance of the anticipated work. The plan must include a schedule of all activities of work and show in detail the special arrangements that will be made to provide for all regulatory and Contract requirements including cordoning off the areas with sufficient roadwork safety signs; providing approved MOT; worksite personnel and citizen safety; necessary lighting; and daily restoration of the work site.

- d. Obtain and comply with all necessary permits and authorizations from the applicable jurisdictions.
- e. Complete all scheduled work and restore the work site as required in the Engineer's approval.
- f. Lighting during nighttime operations:
  - 1) During active nighttime operations, furnish, place and maintain lighting sufficient to permit proper workmanship and inspection. Use lighting with 5 ft•cd minimum intensity. Arrange the lighting to prevent interference with traffic or produce undue glare to property owners. Operate such lighting only during active nighttime construction activities. Provide a light meter to demonstrate that the minimum light intensity is being maintained.
  - 2) Lighting may be accomplished by the use of portable floodlights, standard equipment lights, existing street lights, temporary street lights, or other lighting methods approved by Engineer.
  - 3) Submit a lighting plan at the Preconstruction Conference for review and acceptance by Engineer. Submit the plan on standard size plan sheets (not larger than 24 by 36 inch), and on a scale of either 100 or 50 feet to 1 inch. Do not start night work prior to the Engineer's acceptance of the lighting plan.
  - 4) During active nighttime operations, furnish, place and maintain variable message signs to alert approaching motorists of lighted construction zones ahead. Operate the variable message signs only during active construction activities.
  - 5) Where night work is required by the Contract Documents, include compensation for lighting for night work in the Contract prices for the various items of the Contract. Take ownership of all lighting equipment for night work.
- 3. Sequence of Operations: Do not open up work to the prejudice of work already started. Engineer may require Contractor to finish a section on which work is in progress before starting work on any additional section.
- 4. Interference with Traffic:
  - a. At all times conduct the Work in such manner and in such sequence as to ensure the least practicable interference with traffic. Operate all vehicles and other equipment safely and without hindrance to the traveling public. Park all private vehicles outside the clear zone. Place materials authorized to be stored along the roadway so as to cause no obstruction to the traveling public as possible.
  - b. Where existing pavement is to be widened and stabilizing is not required, prevent any open trench from remaining after working hours by scheduling operations to place the full thickness of widened base by the end of each day. Do not construct widening strips simultaneously on both sides of the road, except where separated by a distance of at least 1/4 mile along the road and where either the work of excavation has not been started or the base has been completed.
- 5. Coordination with other contractors:
  - a. Sequence the work and dispose of materials so as not to interfere with the operations of other contractors engaged upon adjacent work; join the work to that of others in a proper manner, in accordance with the spirit of the Contract Documents; and perform the work in the proper sequence in relation to that of other contractors; all as may be directed by Engineer.
  - b. Contractor is responsible for any damage done by him or his agents to the work performed by another contractor.
- 6. Drainage: Conduct the operations and maintain the work in such condition to provide adequate drainage at all times. Unless otherwise required by the Contract Documents, do not obstruct existing functioning storm drains, gutters, ditches, and other run-off facilities.
- 7. Fire Hydrants: Keep fire hydrants on or adjacent to the roadway accessible to fire apparatus at all times, and do not place any material or obstruction within 15 feet of any fire hydrant.
- 8. Protection of Structures: Do not operate heavy equipment close enough to pipe headwalls or other structures to cause their displacement.
- 9. Fencing: Erect permanent fence as a first order of business on all projects that include fencing where Engineer determines that the fencing is necessary to maintain the security of livestock on adjacent property, or for protection of pedestrians who are likely to gain access to the project from adjacent property.
- 10. Contaminated Materials:
  - a. When the construction operations encounter or expose any abnormal condition that may indicate the presence of a contaminated material, discontinue such operations in the vicinity of the abnormal condition and notify Engineer immediately. Be alert for the presence of tanks or barrels; discolored earth, metal, wood, ground water, etc.; visible fumes; abnormal odors; excessively hot earth; smoke; or other conditions that appear abnormal as possible indicators of the presence of contaminated materials. Treat these conditions with extraordinary caution.
  - b. Make every effort to minimize the spread of Contaminated Material into uncontaminated areas.
  - c. Do not resume the construction operations until so directed by Engineer.
  - d. Dispose of the Contaminated Material in accordance with the requirements and regulations of any Local, State, or Federal

agency having jurisdiction. Where Contractor performs work necessary to dispose of Contaminated material, and the Contract does not include pay items for disposal, the Department will pay for this work as unforeseeable work.

- e. The Department may agree to hold harmless and indemnify Contractor for damages when Contractor discovers or encounters Contaminated materials or pollutants during the performance of services for the Department when the presence of such materials or pollutants were unknown or not reasonably discoverable. Such indemnification agreements are only effective if Contractor immediately stops work and notifies the Department of the Contaminated material or pollutant problem.
- f. Such indemnification agreement is not valid for damages resulting from Contractor's willful, wanton, or intentional conduct or the operations of Contaminated and Hazardous Material Contractors.

L. Qualifications of Contractor's Personnel

- 1. Meet the personnel qualifications requirements stipulated in Article 105 of the DTPW Specifications.
- 2. Provide competent, careful, and reliable superintendents, foremen, and workmen. Provide workmen with sufficient skill and experience to properly perform the work assigned to them. Provide workmen engaged on special work, or skilled work, such as bituminous courses or mixtures, concrete bases, pavements, or structures, or in any trade, with sufficient experience in such work to perform it properly and satisfactorily and to operate the equipment involved. Provide workmen that shall make due and proper effort to execute the work in the manner prescribed in the Contract Documents, or Engineer may take action as prescribed below.
- 3. It is prohibited as a conflict of interest for a Contractor to subcontract with a Consultant to perform Contractor Quality Control when the Consultant is under contract with the Department to perform work on any project described in Contractor's Contract with the Department. Prior to approving a Consultant for Contractor Quality Control, Contractor shall submit to the Department a Certificate from the proposed Consultant certifying that no conflict of interest exists.
- 4. Whenever Engineer determines that any person employed by Contractor is incompetent, unfaithful, intemperate, disorderly, or insubordinate, Engineer will provide written notice and Contractor shall discharge the person from the work. Do not employ any discharged person on the Project without the written consent of Engineer. If Contractor fails to remove such person or persons, Engineer may withhold all payments that are or may become due, or suspend the work until Contractor complies with such orders. Protect, defend, indemnify, and hold the County, its agents, officials, and employees harmless from all

claims, actions, or suite arising from such removal, discharge, or suspension of employees.

M. Temporary Suspension of Contractor's Operations

- 1. Authority to Suspend Contractor's Operations:
  - a. Engineer has the authority to suspend Contractor's operations, wholly or in part. Engineer will order such suspension in writing, giving in detail the reasons for the suspension. Contract Time will be charged during all suspensions of Contractor's operations.
  - b. Any work in the public right of way may be temporarily suspended by the roadway governing authority. If an extension of Contact time is authorized pursuant to the requirements of the Contract Documents, it will be of a non-compensable nature. All costs associated with temporary suspension including any demobilization or re-mobilization costs are the sole responsibility of the Contractor and no extra compensation will be allowed.
  - c. No additional time extension will be granted to Contractor when the operations are suspended for the following reasons:
    - 1) Contractor fails to comply with the Contract Documents.
    - 2) Contractor fails to carry out orders given by Engineer.
    - 3) Contractor causes conditions considered unfavorable for continuing the Work.
  - d. Immediately comply with any suspension order. Do not resume operations until authorized to do so by Engineer in writing. Any operations performed by Contractor, and otherwise constructed in conformance with the provisions of the Contract, after the issuance of the suspension order and prior to Engineer's authorization to resume operations will be at no cost to the County. Further, failure to immediately comply with any suspension order will also constitute an act of default by Contractor and is deemed sufficient basis in and of itself for the Department to declare Contractor in default, with the exception that Contractor will not have ten calendar days to correct the conditions for which the suspension was ordered.
- 2. Prolonged Suspensions: If Engineer suspends Contractor's operations for an indefinite period, store all materials in such manner that they will not obstruct or impede the traveling public unnecessarily or become damaged in any way. Take every reasonable precaution to prevent damage to or deterioration of the work performed. Provide suitable drainage of the roadway by opening ditches, shoulder drains, etc., and provide any temporary structures necessary for public travel through the project.

3. Permission to Suspend Contractor's Operations: Do not suspend operations or remove equipment or materials necessary for completing the work without obtaining Engineer's written permission. Submit all requests for suspension of operations in writing to Engineer, and identify specific dates to begin and end the suspension. Contractor is not entitled to any additional compensation for suspension of operations during such periods.

4. Suspension of Contractor's Operations-Holidays:

a. Unless Contractor submits a written request to work on a holiday at least ten days in advance of the requested date and receives written approval from Engineer, Contractor must not work on the following days: Martin Luther King, Jr. Day; President's Day, Memorial Day; the Saturday and Sunday immediately preceding Memorial Day; Independence Day; Labor Day; the Saturday, and Sunday immediately preceding Labor Day; Columbus Day, Veterans' Day; Thanksgiving Day; the Friday, Saturday and Sunday immediately following Thanksgiving Day; and December 24 through January 2, inclusive. Contract Time will be charged during these holiday periods regardless of whether or not Contractor's operations have been suspended.

b. During such suspensions, remove all equipment and materials from the clear zone, except those required for the safety of the traveling public and retain sufficient personnel at the job site to properly meet all applicable requirements for: (1) Maintenance of Traffic; and (2) Prevention, Control, and Abatement of Erosion and Water Pollution. Contractor is not entitled to any additional compensation for removal of equipment from clear zones or for compliance with the aforementioned requirements during such holiday periods.

N. Computation of Contract Time

1. Date of Beginning of Contract Time: The Contract Time begins on the effective start date of the "Notice to Proceed." Perform the Work fully, entirely, and in accordance with the Contract Documents within the Contract Time(s) specified in the Contract Documents, or as may be extended in accordance with the provisions herein.

2. Contract Time Extensions:

a. The Department will consider the delays in delivery of materials or component equipment that affect progress on a controlling item of work as a basis for granting a time extension if such delays are beyond the control of Contractor or supplier. Such delays may include an area-wide shortage, an industry-wide strike, or a natural disaster that affects all feasible sources of supply. In such cases, Contractor shall furnish substantiating letters from a representative

number of manufacturers of such materials or equipment clearly confirming that the delays in delivery were the result of an area-wide shortage, an industry-wide strike, etc. No additional compensation will be made for delays caused by delivery of materials or component equipment.

b. The Department will not consider requests for time extension due to delay in the delivery of custom manufactured equipment including traffic signal equipment, highway lighting equipment, etc., unless Contractor furnishes documentation that the order for such equipment was placed in a timely manner, the delay was caused by factors beyond the manufacturer's control, and the lack of such equipment caused a delay in progress on a controlling item of work. No additional compensation will be paid for delays caused by delivery of custom manufactured equipment.

c. The Department will consider the effect of utility relocation and adjustment work on job progress as the basis for granting a time extension only if all the following criteria are met:

1) Delays are the result of either utility work that was not detailed in the plans, or utility work that was detailed in the plans but was not accomplished in reasonably close accordance with the schedule included in the Contract Documents.

2) Utility work actually affected progress toward completion of controlling work items.

3) Contractor took all reasonable measures to minimize the effect of utility work on job progress, including cooperative scheduling of Contractor's operations with the scheduled utility work at the preconstruction conference and providing adequate advance notification to utility companies as to the dates to coordinate their operations with Contractor's operations to avoid delays.

d. As a condition precedent to an extension of Contract Time, Contractor must submit to Engineer:

1) A preliminary request for an extension of Contract Time made in writing to Engineer within ten calendar days after the commencement of a delay to a controlling item of work. If Contractor fails to submit this required preliminary request for an extension of Contract Time, Contractor fully, completely, absolutely and irrevocably waives any entitlement to an extension of Contract Time for that delay. In the case of a continuing delay only a single preliminary request for an extension of Contract Time will be required. Each such preliminary request for an extension of Contract Time shall include as a minimum the commencement date of the delay, the cause of the delay, and

the controlling item of work affected by the delay; and

- 2) Further, Contractor must submit to Engineer a request for a Contract Time extension in writing within 30 days after the elimination of the delay to the controlling item of work identified in the preliminary request for an extension of Contract Time. Each request for a Contract Time extension shall include as a minimum all documentation that Contractor wishes the Department to consider related to the delay, and the exact number of days requested to be added to Contract Time. If Contractor contends that the delay is compensable, then Contractor is also required to submit with the request for a Contract Time extension a detailed cost analysis of the requested additional compensation. If Contractor fails to submit this required request for a Contract Time extension, with or without a detailed cost analysis, depriving Engineer of the timely opportunity to verify the delay and the costs of the delay, Contractor waives any entitlement to an extension of Contract Time or additional compensation for the delay.
- e. Upon timely receipt of the preliminary request of Contract Time from Contractor, Engineer will investigate the conditions, and if it is determined that a controlling item of work is being delayed for reasons beyond the control of Contractor, Engineer will take appropriate action to mitigate the delay and the costs of the delay. Upon timely receipt of the request for a Contract Time extension Engineer will further investigate the conditions, and if it is determined that there was an increase in the time or the cost of performance of the controlling item of work beyond the control of Contractor, then an adjustment of Contract Time will be made, and a monetary adjustment will be made, excluding loss of anticipated profits, and the Contract will be modified in writing accordingly.
- f. The existence of an accepted schedule, including any required update(s), as required by the Contract Documents is a condition precedent to Contractor having any right to the granting of an extension of contract time or any monetary compensation arising out of any delay. Contractor failure to have an accepted schedule, including any required update(s), for the period of potential impact, or in the event the currently accepted schedule and applicable updates do not accurately reflect the actual status of the project or fail to accurately show the true controlling or non-controlling work activities for the period of potential impact, will result in any entitlement determination as to time or money for such period of potential impact being limited solely to the Department's analysis and identification of the actual controlling or non-controlling work activities.

Further, in such instances, the Department's determination as to entitlement as to either time or compensability will be final.

#### O. Default and Termination of Contract

##### 1. Determination of Default:

- a. The following acts or omissions constitute acts of default and, except as to subparagraph 10) below, the Department will give notice, in writing, to Contractor and his surety for any delay, neglect or default, if Contractor:
  - 1) Fails to begin the work under the Contract within the time specified in the Notice to Proceed;
  - 2) Fails to perform the work with sufficient workmen and equipment or with sufficient materials to ensure prompt completion of the Contract;
  - 3) Performs the work unsuitably, or neglects or refuses to remove materials or to perform anew such work that Engineer rejects as unacceptable and unsuitable;
  - 4) Discontinues the prosecution of the work, or fails to resume discontinued work within a reasonable time after Engineer notifies Contractor to do so;
  - 5) Becomes insolvent or is declared bankrupt, or files for reorganization under the bankruptcy code, or commits any act of bankruptcy or insolvency, either voluntarily or involuntarily;
  - 6) Allows any final judgment to stand against him unsatisfied for a period of ten calendar days;
  - 7) Makes an assignment for the benefit of creditors;
  - 8) Fails to comply with Contract requirements regarding minimum wage payments;
  - 9) Fails to comply with Engineer's written suspension of work order within the time allowed for compliance and which time is stated in that suspension of work order; or
  - 10) For any other cause whatsoever, fails to carry on the work in an acceptable manner, or if the surety executing the bond, for any reasonable cause, becomes unsatisfactory in the opinion of the Department.
- b. For a notice based upon reasons stated in subparagraphs a. 1) through 8) and 10) above: if Contractor, within a period of ten calendar days after receiving the notice described above, fails to correct the conditions of which complaint is made, the Department will, upon written certificate from Engineer of the fact of such delay, neglect, or default and Contractor's failure to correct

such conditions, have full power and authority, without violating the Contract, to take the prosecution of the work out of the hands of Contractor and to declare Contractor in default.

- c. If Contractor, after having received a prior notice described above for any reason stated in subparagraph a. 2), 3), 4), 5), 6) or 8), commits a second or subsequent act of default for any reason covered by the same subparagraph a. 2), 3), 4), 5), 6) or 8) as stated in the prior notice, and regardless whether the specific reason is the same, then, regardless of whether Contractor has cured the deficiency stated in that prior notice, the Department will, upon written certificate from Engineer of the fact of such delay, neglect or default and Contractor's failure to correct such conditions, have full power and authority, without any prior written notice to Contractor and without violating the Contract, to take the prosecution of the work out of the hands of Contractor and to declare Contractor in default.
- d. Regarding subparagraph a. 9), if Contractor fails to comply with Engineer's written suspension of work order within the time allowed for compliance and which time is stated in that suspension of work order, the Department will, upon written certificate from Engineer of the fact of such delay and Contractor's failure to correct that condition, have full power and authority, without violating the Contract, to immediately take the prosecution of the work out of the hands of Contractor and to declare Contractor in default.
- e. The Department has no liability for anticipated profits for unfinished work on a Contract that the Department has determined to be in default.

## 2. Completion of Work by Department:

- a. Upon declaration of default, the Department will have full power to appropriate or use any or all suitable and acceptable materials and equipment on the site and may enter into an agreement with others to complete the work under the Contract, or may use other methods to complete the work in an acceptable manner. The Department will charge all costs that the Department incurs because of Contractor's default, including the costs of completing the work under the Contract, against Contractor. If the Department incurs such costs in an amount that is less than the sum that would have been payable under the Contract had the defaulting Contractor completed the work then the Department will pay the difference to the defaulting Contractor. If the Department incurs such costs in an amount that exceeds the sum that would have been payable under the Contract, then Contractor and the surety

shall be liable and shall pay the County the amount of the excess.

- b. If, after the ten day notice period and prior to any action by the Department to otherwise complete the work under the Contract, Contractor establishes his intent to prosecute the work in accordance with the Department's requirements, then the Department may allow Contractor to resume the work, in which case the Department will deduct from any monies due or that may become due under the Contract, any costs to the County incurred by the delay, or from any reason attributable to the delay.

## 3. Termination of Contract for Convenience:

- a. The Department may terminate the entire Contract or any portion thereof, if the Department determines termination is in the County's interest. Engineer will deliver to Contractor a Written Notice of Termination specifying the extent of termination and the effective date.
- b. When the Department terminates the entire Contract, or any portion thereof, before Contractor completes all items of work in the Contract, the Department will make payment for the actual number of units or items of work that Contractor has completed, at the Contract unit price, and as approved by Engineer for items of work partially completed, and such payments will constitute full and complete compensation for such work or items. No payment of any kind or amount will be made for items of work not started. The Department will not consider any claim for loss of anticipated profits, or overhead of any kind (including home office and jobsite overhead or other indirect impacts).
- c. The Department will consider reimbursing Contractor for actual cost of mobilization (when not otherwise included in the Contract) including moving equipment to the job where the volume of the work that Contractor has completed is de minimis and thereby too small to compensate Contractor for these expenses under the Contract unit prices.
- d. The Department may purchase at actual cost acceptable materials and supplies procured for the work, that the Department has inspected, tested, and approved and that Contractor has not incorporated in the work. Submit the proof of actual cost, as shown by receipted bills and actual cost records, at such points of delivery as Engineer may designate.
- e. Termination of a contract or a portion thereof, under the provisions of this Subarticle, does not relieve Contractor or the surety of its responsibilities for the completed portion of the Contract or its obligations for and concerning any just claims arising out of the work performed.



P. Release of Contractor's Responsibility

The Department considers the Contract complete when Contractor has completed all work and requirements of the Contract and the Department has accepted the Work. The Department will then release Contractor from further obligation except as set forth in the Contract Bonds, and except as allowed by the Contract Documents subsequent to Final Payment.

1.07 MEASUREMENT AND PAYMENT

A. Compensation

1. Compensation provided by the Contract, through the various scheduled items having awarded Contract Unit Prices, constitutes full payment for completing the Work and meeting all requirements of the Contract Documents. Approved payments will be made only under items having awarded Contract Unit Prices that are measured and accepted by Engineer.
2. The aforementioned compensation includes:
  - a. Full payment for furnishing any material, supply, equipment, tool, labor, supervision, or meeting any requirement that is reasonably inferred or incidental to the Work whether or not specifically called for by the Contract Documents.
  - b. Items of work that do not have awarded Contract Unit Prices, even if the items appear within the Articles of these Specifications or anywhere else in the Contract Documents. These items will not be measured separately for payment. Compensation for performing any work or meeting any requirement associated with these items is included in approved payments made under the various scheduled items having awarded Contract Unit Prices.
3. For Job Order Contracts, the Contract Unit Price, where referenced anywhere in these Contract Documents, is the price which results from the multiplication of the unit price provided by the County on the Project Bid Form times the awarded Contractor's percentage factor. All compensation for services called for in this Contract shall be made on the basis of the Contract Unit Prices for quantities based upon the actual work performed and accepted by Engineer. Such compensation shall be complete payment for all phases of the operation and no additional payment shall be made for any reason whatsoever.
4. Miami-Dade County offers a payment option that will expedite County payments to your organization via Automatic Clearing House transfers instead of the issuance and mailing of a County check. More information is available at <http://www.miamidade.gov/finance/vendor-payment.asp#5> The form can also be found on the Appendices to the Special Provisions

B. Contingency Allowance Account

1. A Contingency Allowance account has been established for the Work under this Contract. The Total Contract award amount will include no more than ten percent (10%) Contingency Allowance Account. Contractor is not entitled to funds from the Contingency Allowance Account unless, at the discretion of Engineer, work is directed to be performed that is beyond the scope of established pay items. Contractor shall perform such work only upon receipt of an executed Miami-Dade-County Contingency Allowance Account expenditure form from Engineer.

C. Florida Power And Light Connection Allowance

1. County will reimburse Contractor, at invoice cost, for the services of the Florida Power and Light (FPL) connection fees required by Engineer. The necessary invoices shall be submitted to Engineer for inclusion in the payment requisition. This payment will be made from the appropriate dedicated allowance. If no dedicated allowance is provided, then payment shall be made from the Contingency Allowance Account.

D. Retainage; Punch List Requirements

1. Amount of retainage.
  - a. An amount of 5-percent retainage will be withheld from each progress payment made to Contractor.
2. Project closeout (Punch List).
  - a. Within 21 days of reaching Substantial Completion and performance of required inspection(s), Engineer, with cooperation of Contractor, will develop a single punch list subject to the provisions of Section 218.735 (7) of the Florida Statutes (F.S.), listing all items necessary to render complete, satisfactory, and acceptable to Engineer all work and requirements of the Contract. Contractor will review and comment as necessary to assist Engineer in the preparation of the final draft of the list during the aforementioned timeframe.
  - b. Engineer will provide Contractor with the Punch List within 5 days after the List has been developed and reviewed as provided in Subarticle 2.a above. Contractor must immediately work on completion of the items listed and provide to Engineer within 5 days of receipt of the Punch List, a final schedule for the completion of all pending work and requirements of the Contract. The schedule must provide for the final completion of all Contract requirements and acceptance by the Engineer prior to the expiration of the Contract.
  - c. For work order or multiphase projects:
    - 1) Provide a punch list listing all items necessary to render complete, satisfactory, and acceptable to Engineer all work and

requirements for each phase or work order as applicable.

- 2) All time limitations and requirements stipulated above apply except that the timeframe requirements for the individual punch lists are based on the specific phase or work order's substantial completion.
3. Release of Retainage.
    - a. The release of retainage is subject to Section 218.735 (7), F.S. and may be requested as follows:
      - 1) Upon completion of all items on the punch list and their acceptance by Engineer, Contractor may submit a payment request for all remaining retainage withheld by the County
      - 2) under this Contract. If a good faith dispute exists as to whether one or more items identified on the Punch List have been completed pursuant to the Contract requirements, the County may continue to withhold an amount equal to 150 percent of the total costs to complete such items.
      - 3) The County is not required to pay or release any amounts of retainage that are the subject of a good faith dispute, the subject of a claim brought pursuant to Section 255.05, F.S., or otherwise the subject of a claim or demand by the County or Contractor.

#### E. Measurement of Quantities

1. Measurement Standards: Engineer will measure all work completed under the Contract in accordance with the United States Standard Measures.
2. Method of Measurements: Engineer will take all measurements horizontally or vertically as applicable.
3. Determination of Pay Areas:
  - a. Final Calculation: When measuring items paid for on the basis of area of finished work, where the pay quantity is designated to be determined by calculation, Engineer will use lengths and widths in the calculations based on the station to station dimensions shown on the plans; the station to station dimensions actually constructed within the limits designated by Engineer; or the final dimensions measured along the surface of the completed work within the neat lines shown on the Plans or designated by Engineer. Engineer will use the method or combination of methods of measurement that reflect, with reasonable accuracy, the actual surface area of the finished work as Engineer determines.
4. Construction Outside Authorized Limits: Engineer will not pay for surfaces constructed over a greater area than authorized, or for material that Contractor has moved from outside of slope stakes and lines shown

on the plans, except where Engineer provides written instruction for Contractor to perform such work.

5. Truck Requirements: Provide all trucks with numbers and certify that all trucks used have a manufacturer's certification or permanent decal showing the truck capacity rounded to the nearest tenth of a cubic yard placed on both sides of the truck. This capacity will include the truck body only and any side boards added will not be included in the certified truck body capacity. Ensure the lettering and numbers are legible for identification purposes at all times.
6. Ladders and Instrument Stands for Bridge Projects:
  - a. On bridge projects, in order to facilitate necessary measurements, provide substantial ladders to the tops of piers and bents, and place and move such ladders as Engineer directs.
  - b. For bridge projects crossing water or marshy areas, supply fixed stands for instrument mounting and measurements, in accordance with the details stipulated in the Specifications for the project.

#### F. Fuel Adjustment

1. DTPW will, in the Contract Documents, provide an estimated quantity for fuel requirements for diesel to cover the Work specified in the Contract. Price adjustments will be made only for the amount of diesel fuel estimated by the DTPW required to complete the Contract. The requirement of fuel for each pay item is estimated by multiplying FDOT's standard fuel factor for that pay item by the quantity of that pay item. On Contracts with an original Contract Time in excess of 120 calendar days, DTPW will make price adjustments on each applicable progress estimate to reflect increases or decreases in the price of diesel from those in effect during the month in which bids were received. The Contractor will not be given the option of accepting or rejecting these adjustments. Price adjustments for fuel will be made only when the current fuel price (CFP) varies by more than 5% from the price prevailing in the month when bids were received (BFP), and then only on the portion that exceeds 5%.
2. Price adjustments will be based on the monthly bulk average price for diesel as derived by FDOT. These average indexes shall be determined by averaging bulk fuel prices on the first day of each month as quoted by major oil companies that are reasonably expected to furnish fuel for projects in the State of Florida. Average price indices for will be available on FDOT Construction Office website before the 15th of each month, at the following URL: <https://www.fdot.gov/construction/fuel-bit/fuel-bit.shtml>.
3. Payment will be based on the quantities shown on the progress estimate on all items for which established standard fuel factors are on a file maintained by DTPW. Payment on progress estimates will be adjusted to reflect adjustments in the prices for diesel in accordance with the following:

- a. When fuel prices have decreased between month of bid and month of this progress estimate:
    - 1)  $A_i = F_i (P_i - 0.95 P_b)$  during a period of decreasing prices.
    - 2)  $A_i$  = Total dollar amount - positive or negative - of the cost adjustment for fuel used by the Contractor during the month "i."
    - 3)  $F_i$  = Total gallons calculated as being used during the month.
    - 4)  $P_i$  = Average price for fuel prevailing during month "i."
    - 5)  $P_b$  = Average price for fuel prevailing during the month "b" when bids were received on this Contract.
  - b. When fuel prices have increased between month of bid and month of this progress estimate:
    - 1)  $A_i = F_i (P_i - 1.05 P_b)$  during a period of increasing prices.
    - 2)  $A_i$  = Total dollar amount - positive or negative - of the cost adjustment for fuel used by the Contractor during the month "i."
    - 3)  $F_i$  = Total gallons calculated as being used during the month.
    - 4)  $P_i$  = Average price for fuel prevailing during month "i."
    - 5)  $P_b$  = Average price for fuel prevailing during the month "b" when bids were received on this Contract
4. Payment will be made on the current progress estimate to reflect the index difference at the time Work was performed.
  5. Adjustments will be paid or charged to the Prime Contractor only. Any Contractor receiving an adjustment under this provision shall distribute the proper proportional part of such adjustment to subcontractors who perform applicable Work
- G. Bituminous Material
- a. On Contracts having an original Contract Time of more than 365 calendar days, or more than 5,000 tons of asphalt concrete, the Department will adjust the bid unit price for bituminous material, excluding cutback and emulsified asphalt to reflect increases or decreases in the Asphalt Price Index (API) of bituminous material from that in effect during the month in which bids were received. Contractor will not be given the option of accepting or rejecting this adjustment. Bituminous adjustments will be made only when the current API (CAPI) varies by more than 5% of the API prevailing in the month when bids were received (BAPI), and then only on the portion that exceeds 5%.
    - b. The Department will use the API determined by FDOT and available on the FDOT Office of Construction website L: <https://www.fdot.gov/construction/fuel-bit/fuelbit.shtm>.
    - c. Payment on progress estimates will be adjusted to reflect adjustments in the prices for bituminous materials in accordance with the following:
      - 1) \$ Adjustment = (ID)(Gallons)
      - 2) Where ID = Index Difference = [CAPI - 0.95(BAPI)] when the API has decreased between the month of bid and month of this progress estimate.
      - 3) Where ID = Index Difference = [CAPI - 1.05(BAPI)] when the API has increased between the month of bid and month of this progress estimate.
      - 4) Payment will be made on the current progress estimate to reflect the index difference at the time work was performed.
      - 5) For asphalt concrete items payable by the ton, the number of gallons will be determined assuming a mix design with 6.25 percent liquid asphalt weighing 8.58 lb/gal.
      - 6) Asphalt concrete items payable by the square yard will be converted to equivalent tons assuming a weight of 100 lb/yd<sup>2</sup> per inch.
2. Non-Duplication of Payment: In cases where the basis of payment clause in these Specifications relating to any unit price in the bid schedule requires that the unit price cover and be considered compensation for certain work or material essential to the item, the Department will not measure or pay for this same work or material under any other pay item that may appear elsewhere in these Specifications.
- H. Material Adjustments for Aluminum, PVC, and Copper.
1. DTPW will make price adjustments for aluminum, PVC, and copper materials included in the Contract pay item list in accordance with the following procedures:
    - a. Prepare separate Contractor's Certification of Quantities for each material invoice month using the FDOT forms for Material Price Adjustment. <https://www.fdot.gov/construction/material-price-adjustment>.
    - b. Submit certifications for materials purchased. Submit certifications for subsequent estimate periods as directed by the Engineer, based on the quantity of each material purchased within the estimate period. Material certifications reflecting quantities beyond the final contract quantity shall not be accepted. Ensure each certification includes the Contract Number, Certification Date and Number, the period the certification

represents, and the quantity represented by each invoice for each pay item. Submit material invoices with each certification and clearly identify the following:

- 1) Pay Item Number
  - 2) Certification Quantity
  - 3) Invoice Number
  - 4) Invoice Date
  - 5) Invoice Quantity
  - 6) Invoice Unit Price
  - 7) Invoice Total
2. On Contracts with an original Contract Time of more than 120 days, DTPW will adjust the unit price to reflect increases or decreases in material costs from those in effect during the month in which bids were received. The contractor will not be given the option of accepting or rejecting these adjustments. Price adjustments will be made only when the invoice month material price index (IMP) varies by more than 5% from the price index prevailing in the month when the bids were received (BMP), and then only on the portion that exceeds 5%.
  3. DTPW will use factors to determine the percentage of unit price applicable to material only. Price Adjustments will be based on the USDOL monthly Producer Price Index (PPI). The Material Price indices will be available on the FDOT Construction Office website before the 15th of each month at the following website: <https://www.fdot.gov/construction/material-priceadjustment>
  4. Payment on progress estimates will be adjusted to reflect adjustments in the prices for aluminum, PVC, and copper materials in accordance with the following:
    - a.  $\$ \text{ Adjustment} = (\text{quantity})(\text{unit price})(\text{material factor})(\text{ID})$
    - b. Where  $\text{ID} = \text{Index \% Difference} = [\text{IMP} - 0.95(\text{BMP})] / \text{BMP}$  when the IMP has decreased between the month of bid and the month of material invoice.
    - c. Where  $\text{ID} = \text{Index \% Difference} = [\text{IMP} - 1.05(\text{BMP})] / \text{BMP}$  when the IMP has increased between the month of bid and the month of material invoice.
  5. A line-item adjustment will be made on the last progress estimate prior to the final estimate to each applicable pay item to reflect the cumulative value of all Contractor Certification of Quantities submitted throughout the duration of the contract.
  6. Adjustments will be paid or charged to the Prime Contractor only. Any Contractor receiving an adjustment under this provision for work performed by a subcontractor shall distribute such adjustment to subcontractors who perform applicable work.
  7. DTPW reserves the right to audit the Contractor's records pertaining to the material certifications submitted for this Contract.

#### 1. Material Adjustments for Steel Guardrail

1. DTPW will make price adjustments for steel guardrail materials included in the Contract pay item list in accordance with the following procedures:
2. Prepare separate Contractor's Certification of Quantities for each material invoice month using the FDOT form for Material Price Adjustment. <https://www.fdot.gov/construction/material-price-adjustment>.
3. Submit certifications for materials purchased. Submit certifications for subsequent estimate periods as directed by the Engineer, based on the quantity of each material purchased within the estimate period. Material certifications reflecting quantities beyond the final contract quantity shall not be accepted. Ensure each certification includes the Contract Number, Certification Date and Number, the period the certification represents, and the quantity represented by each invoice for each pay item. Submit material invoices with each certification and clearly identify the following:
  4. Pay Item Number
  5. Certification Quantity
  6. Invoice Number
  7. Invoice Date
  8. Invoice Quantity
  9. Invoice Unit Price
  10. Invoice Total
11. On Contracts with an original Contract Time of more than 120 days, DTPW will adjust the unit price to reflect increases or decreases in material costs from those in effect during the month in which bids were received. The contractor will not be given the option of accepting or rejecting these adjustments. Price adjustments will be made only when the invoice month material price index (IMP) varies by more than 5% from the price index prevailing in the month when the bids were received (BMP), and then only on the portion that exceeds 5%.
12. DTPW will use factors to determine the percentage of unit price applicable to material only. Price Adjustments will be based on the USDOL monthly Producer Price Index (PPI). The Material Price indices will be available on the FDOT Construction Office website before the 15th of each month at the following website: <https://www.fdot.gov/construction/material-price-adjustment>.
13. Payment on progress estimates will be adjusted to reflect adjustments in the prices for aluminum, PVC, and copper materials in accordance with the following:
  - a.  $\$ \text{ Adjustment} = (\text{quantity})(\text{unit price})(\text{material factor})(\text{ID})$
  - b. Where  $\text{ID} = \text{Index \% Difference} = [\text{IMP} - 0.95(\text{BMP})] / \text{BMP}$  when the IMP has decreased between the month of bid and the month of material invoice.

c. Where  $ID = \text{Index \% Difference} = \frac{[IMP - 1.05(BMP)]}{BMP}$  when the IMP has increased between the month of bid and the month of material invoice.

14. : A line-item adjustment will be made on the last progress estimate prior to the final estimate to each applicable pay item to reflect the cumulative value of all Contractor Certification of Quantities submitted throughout the duration of the contract.
15. Adjustments will be paid or charged to the Prime Contractor only. Any Contractor receiving an adjustment under this provision for work performed by a subcontractor shall distribute the proper proportional part of such adjustment to subcontractors who perform applicable work.
16. DTPW reserves the right to audit the Contractor's records pertaining to the material certifications submitted for this Contract.

J. Lump Sum Quantities

1. Error in Lump Sum Quantity: Where the Department designates the pay quantity for an item to be a lump sum and the plans show an estimated quantity, the Department will adjust the lump sum compensation only in the event that either Contractor submits satisfactory evidence or the Department determines from satisfactory evidence that a difference exists between the original plan quantity and final quantity of greater than 5 percent.
2. Authorized Changes in Work: Where the Department designates the pay quantity for an item to be a lump sum and the plans show an estimated quantity, the Department will adjust compensation for that item proportionately when an authorized plan change is made which results in an increase or decrease in the quantity of that item. When the plans do not show an estimated plan quantity or the applicable specifications do not provide adjustments for contingencies, the Department will compensate for any authorized plan change resulting in an increase or decrease in the cost of acceptably completing the item by establishing a new unit price through a Change Order.

K. Deleted Work

1. The Department will have the right to cancel the portions of the Contract relating to the construction of any acceptable item therein, by the payment to Contractor of a fair and equitable amount covering all items of cost incurred prior to the date that Engineer cancels the work.

L. Partial Payments

1. General:
  - a. Engineer will make partial payments on monthly estimates based on the amount of work that Contractor completes during the month (including delivery of certain materials, as specified herein below). Engineer will make approximate monthly payments, and

the Department will correct all partial estimates and payments in the subsequent estimates and in the final estimate and payment.

- b. The Department will base the amount of such payments on the total value of the work that Contractor has performed to the date of the estimate, based on the quantities completed as determined by Engineer and the Contract prices, less payments previously made and less any retainage withheld.

2. Withholding Payment for Defective Work: If the Department discovers any defective work or material prior to the final acceptance, or if the Department has a reasonable doubt as to the integrity of any part of the completed work prior to final acceptance, then the Department will not allow payment for such defective or questioned work until Contractor has remedied the defect and removed any causes of doubt.

3. Partial Payments for Delivery of Certain Materials:

a. General:

- 1) The Department may allow partial payments for new materials that will be permanently incorporated into the Project and are stockpiled in approved locations in the project vicinity. Stockpile materials so that they will not be damaged by the elements.
- 2) The following conditions apply to all partial payments for stockpiled materials:
  - a) There must be reasonable assurance that the stockpiled material will be incorporated into the Project.
  - b) The stockpiled material must be approved by Engineer as meeting applicable specifications.
  - c) The total quantity for which partial payment is made shall not exceed the estimated total quantity required to complete the Project.
  - d) Contractor must furnish Engineer with copies of certified invoices to document the value of the materials received. The amount of the partial payment will be determined from invoices for the material up to the unit price in the Contract.
  - e) Delivery charges for materials delivered to the jobsite will be included in partial payments if properly documented.
  - f) Partial payments will not be made for materials which were stockpiled prior to award of the Contract for a project.

b. Partial Payment Amounts: The following partial payment restrictions apply:

- 1) Partial payments less than \$5,000 for any one month will not be processed.
- 2) Partial payments for structural steel and precast prestressed items will not exceed 85% of the Contract price for the item. Partial payments for all other items will not exceed

75% of the Contract price of the item in which the material is to be used.

- 3) Partial payment will not be made for aggregate and base course material received after paving or base construction operations begin except when a construction sequence designated by the Department requires suspension of paving and base construction after the initial paving operations, partial payments will be reinstated until the paving and base construction resumes.

4. Certification of Payment to Subcontractors:

- a. The term "subcontractor," as used herein, includes persons or firms furnishing materials or equipment incorporated into the work or stockpiled for which the Department has made partial payment and firms working under equipment-rental agreements. Contractor is required to pay all subcontractors for satisfactory performance of their Contracts before the Department will make a further progress (partial) payment. Contractor shall also return all retainage withheld to the subcontractors within 30 days after the subcontractor's work is satisfactorily complete, as determined by the Department. Prior to receipt of any progress (partial) payment, Contractor shall certify that all subcontractors having an interest in the Contract were paid for satisfactory performance of their contracts and that the retainage is returned to subcontractors within 30 days after satisfactory completion of the subcontractor's work. Provide this certification in the form designated by the Department.
- b. Within 30 days of Contractor's receipt of the final progress payment or any other payments thereafter, except the final payment, Contractor shall pay all subcontractors and suppliers having an interest in the Contract for all work completed and materials furnished. The Department will honor an exception to the above when Contractor demonstrates good cause for not making any required payment and furnishes written notification of any such good cause to both the Department and the affected subcontractors or suppliers within said 30-day period.

M. Record of Construction Materials

1. General: For all construction materials used in the construction of the Project, (except materials for materially generally classed as non-commercial), preserve for the Department's inspection the invoices and records of the materials for a period of five years from the date of completion of the Project. Apply this requirement when subcontractors purchase materials, and obtain the invoices and other materials records from the subcontractors. By providing the materials,

Contractor certifies that all invoices will be maintained for the required period.

N. Recovery Rights, Subsequent to Final Payment

1. The Department reserves the right, if it discovers an error in the partial or final payments, or if it discovers that Contractor performed defective work or used defective materials, after the final payment has been made, to claim and recover from Contractor or his surety, or both, by process of law, such sums as may be sufficient to correct the error or make good the defects in the work and materials.
2. Retain all records pertaining to the Project for a period of five years from the date of Engineer's final acceptance of the Project and final payment, or greater if required by record retention laws. Upon request, make all such records available to the Department or its representative. For the purpose of this Article, records include all books of account, supporting documents, and papers that the Department deems necessary to ensure compliance with the Contract provisions.
3. Make all provisions to comply with Florida House Bill (HB) 1309 comply with public records laws.
  - a. Keep and maintain public records that ordinarily and necessarily would be required by the public agency in order to perform the service;
  - b. Provide the public with access to such public records on the same terms and conditions that the public agency would provide the records and at a cost that does not exceed that provided in chapter 119, F.S., or as otherwise provided by law;
  - c. Ensure that public records that are exempt or that are confidential and exempt from public record requirements are not disclosed except as authorized by law; and
  - d. Meet all requirements for retaining public records and transfer to the public agency, at no cost, all public records in possession of the contractor upon termination of the contract and destroy any duplicate public records that are exempt or confidential and exempt. All records stored electronically must be provided to the public agency in a format that is compatible with the information technology systems of the agency.

# CONSTRUCTION SPECIFICATIONS

SPECIFICATIONS  
TABLE OF CONTENTS

**DIVISION 100 GENERAL CONSTRUCTION OPERATIONS**

---

101	MOBILIZATION (REV. 03-12-2013)	1
	A. Description	1
	B. Basis of Payment	1
102	MAINTENANCE OF TRAFFIC (REV. 12-15-2015)	1
	A. Description	1
	B. Materials	1
	C. Worksite Traffic Supervisor	2
	D. Submittals	2
	E. Traffic Control	3
	F. Detours	4
	G. Traffic Control Officer	5
	H. Driveway Maintenance	5
	I. Temporary Traffic Control Devices	5
	J. Work Zone Pavement Marking	8
	K. Method of Measurement	8
	L. Submittals	10
	M. Basis of Payment	11
104	PREVENTION, CONTROL, AND ABATEMENT OF EROSION AND WATER POLLUTION (REV. 01-09-12)	12
	A. Description	12
	B. General	12
	C. Control of Contractor's Operations Which May Result in Water Pollution	13
	D. Materials for Temporary Erosion Control	13
	E. Erosion Control Plan	13
	F. Construction Requirements	14
	G. Maintenance of Erosion and Sediment Control Features	15
	H. Protection During Suspension of Contract Time	16
	I. Method of Measurement	16
	J. Basis of Payment	16
105	CONTRACTOR QUALITY CONTROL GENERAL REQUIREMENTS (REV. 08-23-12)	16
	A. General	16
	B. Guidelines for Development of the CQCP	17
	C. Quality Control Plan Submittal	18
	D. Quality Control Documentation	18
	E. Contractor Certification of Compliance	19
	F. Personnel Qualifications	19
	G. FDOT Quality Control Program	24
107	LITTER REMOVAL AND MOWING (REV. 11-25-2015)	24
	A. Description	24
	B. Operation	24
	C. Method of Measurement	25
	D. Basis of Payment	25
110	CLEARING AND GRUBBING (REV. 05-16-11)	25
	A. General	25
	B. Clearing and Grubbing	25
	C. Ownership of Materials	27
	D. Disposal of Materials	27



E. Method of Measurement .....	28
F. Basis of Payment .....	29
110-32 EDGING AND SWEEPING (REV. 06-02-2015) .....	30
A. Description.....	30
B. Equipment .....	30
C. Provide positive means to control dust from edging and sweeping operations. ....	30
D. Method of Operation .....	30
E. Method of Measurement .....	31
F. Basis of Payment.....	31
120 EARTHWORK AND RELATED OPERATIONS.....	31
A. General.....	31
120A BASE PREPARATION FOR NEW SIDEWALK CONSTRUCTION .....	31
A. Description.....	31
B. Method of Measurement .....	31
C. Basis of Payment.....	31
121 FLOWABLE FILL.....	31
A. Description.....	31
B. Materials .....	31
C. Mix Design.....	32
D. Production and Placing .....	32
E. Construction Requirements.....	32
F. Acceptance.....	32
G. Method of Measurement .....	32
H. Basis of Payment .....	32
160 TYPE "B" STABILIZATION (SECTION 160).....	32
A. Page 188, Section 160 - Stabilizing: .....	32
B. Page 189, Subarticle 160-4.1- Commercial and Local Materials – Add the following:.....	33
C. Page 192, Subarticle 160-7.2.1.2- Undertolerances In...; is deleted in its entirety and replaced with the following:.....	33
D. Page 195, Article 160-9- Basis of Payment; Is deleted in its entirety and replaced with the following: .....	33

**DIVISION 200 BASE COURSE**

---

200 LIMEROCK BASE (REV. 08-23-12).....	34
A. Description.....	34
B. Materials .....	34
C. Equipment .....	34
D. Transporting Rock .....	34
E. Spreading Rock .....	34
F. Compacting and Finishing Base.....	35
G. Acceptance Criteria:.....	35
H. Priming and Maintaining .....	37
I. Thickness of Base .....	38
J. Method of Measurement .....	38
K. Basis of Payment .....	38

**DIVISION 300 BITUMINOUS TREATMENTS SURFACE COURSES AND CONCRETE PAVEMENT**

---

327 MILLING OF EXISTING ASPHALT PAVEMENT (REV. 05-14-12).....	39
A. Description.....	39
B. Equipment .....	39
C. Construction .....	39
D. Milled Surface .....	40
E. Method of Measurement .....	40

F. Basis of Payment .....	40
334 HOT MIX ASPHALT .....	40
A. Description.....	41
335 DRIVEWAY TRANSITIONS (REV. 06-23-11) .....	41
A. Description.....	41
B. Materials .....	41
C. Preparation and Construction.....	41
D. Method of Measurement .....	41
E. Basis of Payment.....	41
339 MISCELLANEOUS ASPHALT PAVEMENT (REV. 08-25-11) .....	41
A. Description.....	41
B. Materials .....	41
C. Foundation.....	41
D. Soil Treatment .....	41
E. Placing Mixture .....	42
F. Compacting Mixture.....	42
G. Surface Requirements .....	42
H. Method of Measurement .....	42
I. Basis of Payment .....	42
344 CONCRETE FOR LAP (OFF-SYSTEM) .....	42
A. Description.....	42

**DIVISION 400 STRUCTURES**

---

425 INLETS, MANHOLES AND JUNCTION BOXES (SECTION 425) .....	43
A. Page 417, Subarticle 425-6.6 - Placing Pipe; The third sentence of this sub-article is modified to read: .....	43
B. Page 417, Subarticle 425-6.7 Backfilling; is modified to include the following:.....	43
C. Page 417, Subarticle 425-8.2 - Adjusted Structures; is expanded to include the following:.....	43
D. Page 418, Subarticle 425-8.3 – Payment Items; is expanded to include the following: .....	43
425A ADJUSTMENT OR RELOCATION OF VALVE, METER AND JUNCTION BOXES .....	43
430 PIPE CULVERTS (REV. 01-12-16).....	43
A. Description.....	43
B. Materials .....	43
C. Type of Pipe to Be Used .....	43
D. Laying Pipe.....	44
E. Removing Existing Pipe .....	45
F. Placing Pipe Under Railroad .....	45
G. Specific Requirements for Concrete Pipe.....	45
H. Specific Requirements for Corrugated Metal Pipe.....	46
I. Specific Requirements for Corrugated Polyethylene Pipe and Polyvinyl Chloride (PVC) Pipe. ....	47
J. Desilting Pipe Culverts, Box Culverts, and Inlet Structures.....	47
K. Method of Measurement .....	48
L. Basis of Payment .....	48
443 FRENCH DRAINS .....	49
A. Description.....	49
B. Materials .....	49
C. Excavating Trench .....	50
D. Laying Pipe.....	50
E. Placing Coarse Aggregate and Backfilling.....	50
F. Method of Measurement .....	50
G. Basis of Payment .....	50

**DIVISION 500 MISCELLANEOUS CONSTRUCTION**

514 GEOTEXTILE (REV. 11-04-11) .....51  
A. Description.....51  
B. Material.....51  
C. Construction Methods.....51  
D. Method of Measurement.....51  
E. Basis of Payment.....51

519 DRIVEWAY PAVEMENT (REV. 08-23-12) .....51  
A. Description.....51  
B. Materials.....51  
C. Preparation and Construction.....51  
D. Method of Measurement.....52  
E. Basis of Payment.....52

520 CONCRETE GUTTER, CURB ELEMENTS, AND TRAFFIC SEPARATOR (SECTION 520).....52  
A. Page 583, Article 520-1, Description: Is expanded to include the following: .....52  
B. Page 583, Article 520-2, Materials: Is amended as follows:.....52  
C. Page 591 Article 520-12, Basis of Payment: Is deleted in its entirety and replaced with the following: .....52

522 CONCRETE SIDEWALK (SECTION 522) .....52  
A. Page 589, Article 522-1, Description: Is expanded to include the following: .....52  
B. Page 589, Article 522-2, Materials; is amended as follows:.....52  
C. Page 591 Article 522-9, Method of Measurement; is expanded to include the following: .....53  
D. Page 591 Article 522-10, Basis of Payment; is deleted in its entirety and replaced with the following:.....53

523 PATTERNED PAVEMENT (REV. 01-06-2015).....53  
A. Description.....53  
B. Materials.....53  
C. Construction.....54  
D. Method of Measurement.....54  
E. Basis of Payment.....54

527 DETECTABLE WARNINGS ON WALKING SURFACES (REV. 12-20-16).....54  
A. Description.....54  
B. Materials.....54  
A. Installation Procedures.....55  
B. Method of Measurement.....55  
C. Basis of Payment.....56

528 RIPRAP FOR DRAINAGE STRUCTURES .....56  
A. This Article is for sand-cement riprap.....56

536 GUARDRAIL.....56  
A. Description.....56  
B. Materials.....56  
C. Setting Posts.....57  
D. Erection of Rail.....57  
E. Existing Guardrail.....58  
F. Method of Measurement.....58  
G. Basis of Payment.....58

538 RESETTING GUARDRAIL .....59  
A. Description.....59  
B. Materials.....59  
C. Construction Methods.....59  
D. Method of Measurement.....59  
E. Basis of Payment.....59

550	FENCING TYPE "B" (SECTION 550).....	59
575	SODDING.....	60
	A. Description.....	60
	B. Materials. Meet the following requirements: .....	60
	C. Construction Methods. ....	60
	D. Maintenance.....	60
	E. Method of Measurement .....	60
	F. Basis of Payment.....	60
575	RELOCATION OF TREES OR PALMS; AND PROTECTION OF EXISTING LANDSCAPE.....	61
	A. Relocation of trees or palms .....	61
	B. Protection of Existing Landscaping .....	62
	C. Method of Measurement: .....	62
	D. Basis of Payment: .....	62
580	LANDSCAPE INSTALLATION.....	62
	A. Description.....	62

**DIVISION 600 TRAFFIC CONTROL DEVICES**

---

600	GENERAL PROVISIONS FOR TRAFFIC CONTROL DEVICES (REV. 04-14-15) .....	63
	A. Description.....	63

**DIVISION 700 TRAFFIC CONTROL**

---

701	AUDIBLE AND VIBRATORY PAVEMENT MARKINGS (REV. 01-07-2014).....	64
	A. Description.....	64
	B. Materials .....	64
	C. Equipment. ....	64
	D. Application.....	64
	E. Thickness: .....	64
	F. Dimensions of Audible Bumps: .....	64
	G. Retroreflectivity:.....	64
	H. Color:.....	65
	I. Reflective Elements:.....	65
	J. Loss:.....	65
	K. Contractor's Responsibility for Notification. ....	65
	L. Protection of Newly Applied Audible and Vibratory Markings.....	65
	M. Observation Period. ....	65
	N. Corrections for Deficiencies. ....	65
	O. Submittals .....	65
	P. Method of Measurement .....	65
	Q. Basis of Payment .....	65
705	OBJECT MARKERS AND DELINEATORS (REV. 08-23-12) .....	65
	A. Description.....	65
	B. Materials .....	65
	C. Installation Requirements.....	66
	D. Method of Measurement .....	66
	E. Basis of Payment.....	66
706	RAISED RETRO-REFLECTIVE PAVEMENT MARKERS AND BITUMINOUS ADHESIVE (REV. 05-02-12).....	66
	A. Description.....	66
	B. Materials .....	66
	C. Equipment. ....	66
	D. Application.....	66
	E. Contractor's Responsibility for Notification. ....	67

	F. Method of Measurement .....	67
	G. Basis of Payment .....	67
710	PAINTED PAVEMENT MARKINGS (REV. 05-02-12) .....	67
	A. Description.....	67
	B. Materials .....	67
	C. Equipment .....	67
	D. Application:.....	67
	E. Tolerances in Dimensions and in Alignment.....	68
	F. Contractor's Responsibility for Notification .....	68
	G. Protection of Newly Painted Pavement Markings .....	68
	H. Corrections for Deficiencies to Applied Painted Pavement Markings.....	68
	I. Submittals.....	68
	J. Method of Measurement .....	69
	K. Basis of Payment .....	69
711	THERMOPLASTIC TRAFFIC STRIPES AND MARKINGS (REV. 05-02-12).....	69
	A. Description.....	69
	B. Materials .....	69
	C. Equipment .....	69
	D. Application .....	70
	E. Tolerances in Dimensions and in Alignment.....	71
	F. Contractor's Responsibility for Notification .....	71
	G. Protection of Newly Applied Traffic Stripes and Markings.....	71
	H. Observation Period .....	71
	I. Corrections for Deficiencies .....	71
	J. Submittals.....	71
	K. Method of Measurement .....	72
	L. Basis of Payment .....	72

3. Payment Items: Payment will be made under:

Item No.	Description	Unit
101- 1-A	Mobilization	LS

**101 MOBILIZATION (REV. 03-12-2013)**

A. Description.

1. Perform preparatory work and operations in mobilizing for beginning work on the Project, including, but not limited to, those operations necessary for the movement of personnel, equipment, supplies, and incidentals to the project site(s) and for the establishment of temporary offices, buildings, safety equipment and first aid supplies, and sanitary and other facilities.
2. Include the costs of bonds and any required insurance and any other preconstruction expense necessary for the start of the work, excluding the cost of construction materials.

B. Basis of Payment.

1. When No Separate Item for Mobilization is Included in the Contract:
  - a. All work and incidental costs specified as being covered under this Article will be included for payment under the several scheduled items of the overall Contract, and no separate payment will be made therefore.
2. When a Separate Pay Item for Mobilization is Included in the Contract:
  - a. The work and incidental costs specified as being covered under this Article will be paid for at the Contract lump sum price for the Mobilization pay item, after an executed Notice to Proceed has been issued, by partial payments made in accordance with the following:
    - 1) For contracts of 120 contract days duration or less, partial payment will be made at 50% of the bid price per month for the first two months. For contracts in excess of 120 contract days duration, partial payment will be made at 25% of the bid price per month for the first four months. In no event shall more than 50% of the bid price be paid prior to commencing construction on the project site.
    - 2) Total partial payments for Mobilization on any project, including when more than one project or job is included in the Contract, will be limited to 10% of the original Contract amount for that project. Any remaining amount will be paid upon completion of all work on the Contract.
    - 3) Retainage, as specified in the Contract Documents, will be applied to all partial payments.
    - 4) Partial payments made on this Subarticle will in no way act to preclude or limit any of the provisions for partial payments otherwise provided for by the Contract.

**102 MAINTENANCE OF TRAFFIC (REV. 12-15-2015)**

A. Description.

1. General:

- a. Maintain, for the duration of the construction period including any temporary suspensions of the Work, all traffic including pedestrian traffic within the limits of the Project starting the day work begins on the Project or the first day Contract time is charged, or on the day work begins on the work order, whichever is earlier .
  - b. Construct and maintain detours.
  - c. Provide facilities for access to residences, businesses, etc., along the Project.
  - d. Furnish, install and maintain traffic control and safety devices during construction in accordance with FDOT Index 600 Series of the FDOT Design Standards, or as directed by Engineer. MOT includes all facilities, devices and operations as required for safety and convenience of the public within the work zone. Provide pickup, removal and disposal of litter and mow turf or vegetation within the MOT limits as required by Article 107.
  - e. Furnish and install work zone pavement markings for maintenance of traffic (MOT) in construction areas.
  - f. Provide any other special requirements for safe and expeditious movement of traffic specified in the Plans or directed by Engineer.
2. Unless otherwise directed by Engineer or required by the Contract Documents, do not maintain traffic over those portions of the Project where no work is to be accomplished or where construction operations will not affect existing roads including sidewalks.
  3. Do not obstruct or create a hazard to any traffic during the performance of the Work, and repair any damage to existing pavement open to traffic.
  4. Traffic may be detoured only upon approval by the County Engineer. Contractor must submit for review and approval an updated MOT plan prior to closure of any roads.
  5. The Department may temporarily suspend all activities, except traffic, erosion control and such other activities that are necessary for project maintenance and safety, for failure to comply with these provisions.
  6. Due to traffic congestion, work hours other than normal established hours may be required by the Engineer. In the case of extreme traffic or weather conditions, Contractor may be required to remove their operation from the roadway and/or right of way, at the discretion of the Engineer or the Traffic Control Officer at no additional compensation.

B. Materials.

1. Meet the following requirements:

Bituminous Adhesive	FDOT Section 970
Temporary Retroreflective Pavement Markers	FDOT Section 990
Paint	FDOT Section 971
Removable Tape	FDOT Section 990
Glass Spheres	FDOT Section 971
Temporary Traffic Control Device Materials	FDOT Section 990
Retroreflective and Nonreflective Sheeting for Temporary Traffic Control Devices	FDOT Section 994

2. Temporary Traffic Control Devices: Use only the materials meeting the requirements of FDOT Section 990, FDOT Section 994, FDOT Design Standards and the Manual on Uniform Traffic Control Devices (MUTCD).
3. Detour: Provide all materials for the construction and maintenance of all detours.
4. Commercial Materials for Driveway Maintenance: Provide materials of the type typically used by FDOT for roadway base construction, including reclaimed asphalt pavement material, and having stability and drainage properties that will provide a firm surface under wet conditions.

C. Worksite Traffic Supervisor.

1. Provide a worksite traffic supervisor meeting the requirements of Article 105. Provide the worksite traffic supervisor with all equipment and materials needed to set up, take down, maintain traffic control, and handle traffic-related situations.
2. Ensure that the worksite traffic supervisor performs the following duties:
  - a. On site direction of all traffic control on the Project.
  - b. Is on site during all MOT set up and take down, and performs a drive through inspection immediately after set up.
  - c. Is on site during all nighttime operations to ensure proper MOT.
  - d. Immediately corrects all safety deficiencies and does not permit minor deficiencies that are not immediate safety hazards to remain uncorrected for more than 24 hours.
  - e. Is available on a 24 hour per day basis and present within 45 minutes after notification of an emergency situation and is prepared to positively respond to repair the work zone traffic control or to provide alternate traffic arrangements.
  - f. Conducts daily daytime and weekly nighttime inspections of projects with predominately daytime work activities, and daily nighttime and weekly daytime inspections of projects with predominantly nighttime work activities of all traffic control devices, traffic flow, pedestrian, bicyclist, and business accommodations. Advise Engineer and the Project personnel of the schedule of these inspections and give them the

opportunity to join in the inspection as is deemed necessary.

3. The Department may disqualify and remove from the Project a worksite traffic supervisor who fails to comply with the provisions of this Article.

D. Submittals

1. Traffic Control Plan

- a. Submit at Contractor's own expense a Traffic Control Plan (TCP) for approval by the County when a final TCP was not provided by the County as part of the original Contract Documents. Sequence the Work in a manner that will minimize disruption of vehicular and pedestrian access through and around the Project's construction area(s).
- b. The TCP must detail procedures and protective measures proposed by Contractor to provide for protection and control of traffic affected by the Work consistent with the following applicable standards:
  - 1) The Contract Documents;
  - 2) "Manual on Uniform Traffic Control Devices for Streets and Highways" (MUTCD) and subsequent revisions and addendums, as published by the U.S. Department of Transportation, Federal Highway Administration;
  - 3) The 600 Series indices of the FDOT Design Standards for Design, Construction, Maintenance and Utility Operations on the State Highway System; and
  - 4) The Miami-Dade County Public Works Manual.
- c. All references to the respective agencies in the above referenced standards shall be construed to also include more stringent requirements of the jurisdictional municipality as applicable for this Work.
- d. The TCP must be signed and sealed by a Professional Engineer registered in the state of Florida and shall include proposed locations and time durations of the following, as applicable:
  - 1) Pedestrian and public vehicular traffic routing.
  - 2) Lane and sidewalk closures, other traffic blockage and lane restrictions and reductions anticipated to be caused by construction operations. Show and describe the proposed location, dates, hours and duration of closure, vehicular and pedestrian traffic routing and management, traffic control devices for implementing pedestrian and vehicular movement around the closures, and details of barricades.
  - 3) Location, type and method of shoring to provide lateral support to the side of an excavation or embankment parallel to an open travel-way.
  - 4) Allowable on-street parking within the immediate vicinity of worksite.
  - 5) Access to buildings immediately adjacent to worksite.
  - 6) Driveways blocked by construction operations.

- 7) Temporary traffic control devices, temporary pavement striping and marking of streets and sidewalks affected by construction
  - 8) Temporary commercial and industrial loading and unloading zones.
  - 9) Construction vehicle reroutes, travel times, staging locations, and number and size of vehicles involved.
- e. Obtain and submit prior to erection, or otherwise impacting traffic, all required permits from all authorities having jurisdiction, including the Department, if applicable.
2. Alternative Traffic Control Plan.
    - a. Where a TCP is provided by the County with the Contract Documents, Contractor may still propose an alternative TCP to the plan presented in the Contract Documents. Prepare the TCP in conformance with the requirements stipulated in this Specification and in the form outlined in the current version of FDOT's Plans Preparation Manual. Indicate in the plan a TCP for each phase of activities. Have Contractor's Engineer of Record sign and seal the alternative plan. Take responsibility for identifying and assessing any potential impacts to a utility that may be caused by the alternate TCP proposed by Contractor, and notify the Department in writing of any such potential impacts to utilities.
    - b. Engineer's approval of the alternate TCP does not relieve Contractor of sole responsibility for all utility impacts, costs, delays or damages, whether direct or indirect, resulting from Contractor initiated changes in the design or construction activities from those in the original Contract Specifications, Design Plans (including TCPs) or other Contract Documents and which effect a change in utility work different from that shown in the Utility Plans, joint project agreements or utility relocation schedules.
    - c. The Department reserves the right to reject any alternative TCP. Obtain Engineer's written approval before beginning work using an alternate TCP. Engineer's written approval is required for all modifications to the TCP. Engineer will only allow changes to the TCP in an emergency without the proper documentation.
  3. Comprehensive Weekly Report:
    - a. Submit to Engineer a comprehensive weekly report of the daily inspections performed and detailing the condition of all traffic control devices (including pavement markings) being used.
    - b. Include assurances in the report that pedestrians are accommodated with a safe, accessible travel path around work sites separated from mainline traffic in compliance with the Americans with Disabilities Act (ADA) Standards for Transportation Facilities, that existing or detoured bicyclist paths are being maintained satisfactorily throughout the Project limits, and that existing businesses in work areas are being provided with adequate entrances for vehicular and pedestrian traffic during business hours.
    - c. When deficiencies are found, the worksite traffic supervisor is to note such deficiencies and include the proposed or implemented corrective actions, including the date corrected.
  - d. Have the worksite traffic supervisor sign the report and certify that all of the above issues are being handled in accordance with the Contract Documents.
    - E. Traffic Control.
      1. Standards: FDOT Design Standards are the minimum standards for the use in the development of all TCPs. The MUTCD, Part VI is the minimum national standard for traffic control for highway construction, maintenance, and utility operations. Follow the basic principles and minimum standards contained in these documents for the design, application, installation, maintenance, and removal of all traffic control devices, warning devices and barriers which are necessary to protect the public and workers from hazards within the Project limits.
      2. Maintenance of Roadway Surfaces:
        - a. Maintain all lanes that are being used for the MOT, including those on detours and temporary facilities, under all weather conditions. Keep the lanes reasonably free of dust, potholes and rutting. Provide the lanes with the drainage facilities necessary to maintain a smooth riding surface under all weather conditions.
      3. Number of Traffic Lanes:
        - a. Maintain one lane of traffic in each direction.
        - b. Maintain two lanes of traffic in each direction at existing four (or more) lane cross roads, where necessary to avoid undue traffic congestion.
        - c. Construct each lane used for MOT at least as wide as the traffic lanes existing in the area before commencement of construction.
        - d. Do not allow traffic control and warning devices to encroach on lanes used for MOT.
        - e. Engineer may allow Contractor to restrict traffic to one-way operation for short periods of time provided that Contractor employs adequate means of traffic control and does not unreasonably delay traffic. When a construction activity requires restricting traffic to one-way operations, locate the flaggers within view of each other when possible. When visual contact between flaggers is not possible, equip them with 2-way radios, official, or pilot vehicles, or use traffic signals.
      4. Crossings and Intersections:
        - a. Provide and maintain adequate accommodations for intersecting and crossing traffic. Do not block or unduly restrict any road or street crossing the Project unless approved by Engineer. Before beginning any construction, provide Engineer the names and phone numbers of persons that can be contacted when signal operation malfunctions.
      5. Access for Residences and Businesses: Provide continuous access to all residences and all places of business.
      6. Protection of the Work from Injury by Traffic: Where traffic would be injurious to a base, surface course, or structure constructed as a part of the work, maintain all traffic



- outside the limits of such areas until the potential for injury no longer exists.
7. Flagger: Provide trained flaggers in accordance with Article 105.
  8. Conflicting Pavement Markings:
    - a. Where the lane use or where normal vehicle or pedestrian paths are altered during construction, remove all pavement markings (paint, tape, thermoplastic, raised pavement markers, etc.) that will conflict with the adjusted vehicle or pedestrian paths. Use of paint to cover conflicting pavement markings is prohibited. Remove conflicting pavement markings using a method that will not damage the surface texture of the pavement and which will eliminate the previous marking pattern regardless of weather and light conditions.
    - b. Remove all pavement markings that will be in conflict with "next phase of operation" vehicle pedestrian paths as described above, before opening to vehicle traffic or use by pedestrians.
    - c. Cost for removing conflicting pavement markings (paint, tape, thermoplastic, raised pavement markers, etc.) to be included in the Project costs for Maintenance of Traffic (General).
  9. Vehicle and Equipment Visibility:
    - a. Equip all pickups and automobiles used on the Project with a minimum of one Class 2 amber or white warning light that meets the Society of Automotive Engineers Recommended Practice SAE J595, dated November 1, 2008, or SAE J845, dated December 1, 2007, and incorporated herein by reference. Existing lights that meet SAE J845, dated March, 1992, or SAE J1318, dated April, 1986, may be used to its end of service life. Warning lights shall be a high intensity amber or white rotating, flashing, oscillating or strobe light. Lights should be unobstructed by ancillary vehicle equipment such as ladders, racks or booms. If the light is obstructed, additional lights will be required. The lights shall be operating when a vehicle is in a work area where a potential hazard exists, when operating the vehicle at less than the average speed for the facility while performing work activities, making frequent stops or called for in the Plans or FDOT Design Standards.
    - b. Equip all other vehicles and equipment with a minimum of 4 square feet of retroreflective sheeting or flashing lights.
    - c. To avoid distraction to motorists, do not operate the lights on the vehicles or equipment when the vehicles are outside the clear zone or behind a barrier.
  10. No Waiver of Liability: Conduct operations in such a manner that no undue hazard results due to the requirements of this Article. The procedures and policies described herein in no way acts as a waiver of any terms of the liability of Contractor or his surety.
- F. Detours.
1. General: Construct and maintain detour facilities wherever it becomes necessary to divert traffic from any existing roadway or bridge, or wherever construction operations block the flow of traffic.
  2. Construction: Plan, construct, and maintain detours for the safe passage of traffic in all conditions of weather. Provide the detour with all facilities necessary to meet this requirement. Where pedestrian facilities are detoured, blocked or closed during the work, provide safe alternate accessible routes through or around the work zone meeting the requirements of the ADA Standards for Transportation Facilities.
  3. Construction Methods: Select and use construction methods and materials that provide a stable and safe detour facility. Construct the detour facility to have sufficient durability to remain in good condition, supplemented by maintenance, for the entire period that the detour is required.
  4. Removal of Detours: Remove detours when they are no longer needed and before the Contract is completed. Take ownership of all materials from the detour and dispose of them, except for the materials on loan from the Department with the stipulation that they are returned.
  5. Detours Over Existing Roads and Streets: When the Department specifies that traffic be detoured over roads or streets outside the Project area, do not maintain such roads or streets. However, maintain all signs and other devices placed for the purpose of the detour.
  6. Operation of Existing Movable Bridges:
    - a. At the pre-construction meeting, the Engineer and the Contractor will select a date for the County to turn over the bridge maintenance and operations responsibilities. In the event that this date is not discussed, the Contractor will take full responsibility at the NTP date.
    - b. In addition to bridge maintenance responsibilities during the duration of the project, Contractor is responsible for having qualified and sufficient number of bridge operators to be able to operate the bridge in accordance USCG regulations – specifically, Title 33- Navigation and Navigable Waters, Chapter I - U.S. Coast Guard, Department of Homeland Security, Subchapter J-Bridges, Part 117--Drawbridge Operation Regulations, Subpart B--Specific Requirements § 117.5.
    - c. County's bridge operators are scheduled as follows:
 

1st Shift:	12am to 8am
2nd Shift:	8am to 4pm
3rd Shift:	4pm to 12am
    - d. This allows the bridge to be operational on a 7 days/week, 365 days per year basis.
    - e. When removing bridges: Once the bridge is removed Contractor is relieved of this responsibility; however, upon completion of the construction of the new bridge and until the new bridge is officially returned to the County, the contractor is obligated to operate the bridge in accordance with the established USCG regulation.
    - f. Make immediate repairs of any damage to such structures caused by use or operations related to the work at no expense to the County, but do not provide routine repairs or maintenance. In the event that use or operations result in damage to a bridge requiring

repairs, give such repairs top priority to any equipment, material, or labor available.

#### G. Traffic Control Officer.

1. Provide uniformed law enforcement officers, including marked law enforcement vehicles, to assist in controlling and directing traffic in the work zone as required by Engineer and when the following types of work is necessary on projects:
  - a. Directing traffic/overriding the signal in a signalized intersection.
  - b. When FDOT Design Standards, Index No. 655 Traffic Pacing for overhead work is called for in the Plans or approved by Engineer.
  - c. When pulling conductor/cable above an open traffic lane on limited access facilities, when called for in the Plans or approved by Engineer.
  - d. When FDOT Design Standards, Index No. 625 Temporary Road Closure 5 Minutes or Less is used.

#### H. Driveway Maintenance.

1. General: Ensure that each residence and business has safe, stable, and reasonable access.
2. Construction Methods:
  - a. Place, level, manipulate, compact, and maintain the material, to the extent appropriate for the intended use.
  - b. As permanent driveway construction is accomplished at a particular location, Contractor may salvage and reuse previously placed materials that are suitable for reuse on other driveways.

#### I. Temporary Traffic Control Devices.

1. Installation and Maintenance:
  - a. Install and maintain temporary traffic control devices as detailed in the Plans, Index 600 of the FDOT Design Standards and when applicable, in accordance with the approved vendor drawings, as provided on FDOT's Approved Products List (APL) and the TSSQPL. Erect the required temporary traffic control devices to prevent any hazardous conditions and in conjunction with any necessary traffic re-routing to protect the traveling public, workers, and to safeguard the work area. Use only those devices that are on the FDOT APL and the TSSQPL. Immediately remove or cover any devices that do not apply to existing conditions.
  - b. All temporary traffic control devices must meet the requirements of National Cooperative Highway Research Program Report 350 (NCHRP 350) or the Manual for Assessing Safety Hardware 2009 (MASH) and current FHWA directives.
  - c. For devices requiring field assembly or special site preparation, vendor drawings shall include all field assembly details and technical information necessary for proper application and installation and must be signed and sealed by a Professional Engineer registered in the State of Florida.

- d. Ensure that the FDOT APL number is permanently marked on the device at a readily visible location. Sheeting used on devices is exempt from this marking requirement.
- e. Notify Engineer of any scheduled operation which will affect traffic patterns or safety sufficiently in advance of commencing such operation to permit his review of the plan for the proposed installation of temporary traffic control devices.
- f. Ensure an employee is assigned the responsibility of maintaining the position and condition of all temporary traffic control devices throughout the duration of the Contract. Keep Engineer advised at all times of the identification and means of contacting this employee on a 24 hour basis.
- g. Keep temporary traffic control devices in the correct position, properly directed, clearly visible and clean, at all times. Ensure that all traffic control devices meet acceptable standards as outlined in American Traffic Safety Services Association (ATSSA) "Quality Guidelines for Temporary Traffic Control Devices and Features". Immediately repair, replace or clean damaged, defaced or dirty devices. Traffic control devices shall not be cleaned while installed/used. Use of warning lights on any temporary traffic control device is prohibited.

#### 2. Work Zone Signs:

- a. Furnish, install, maintain, remove and relocate signs in accordance with the Plans and FDOT Design Standards, Index No. 600. Use signs that meet the material and process requirements of FDOT Section 994. Use Type IV sheeting for fluorescent orange work zone signs. Roll-up signs must meet the requirements of Type VI sheeting. Use Type IV or Type XI sheeting for all other work zone signs. Attach the sign to the sign support using hardware meeting the manufacturer's recommendations on the FDOT APL vendor drawings or as specified in the FDOT Design Standards.

##### 1) Post Mounted Signs:

- a) Meet the requirements of FDOT Section 990-8.

##### 2) Portable Signs:

- a) Use only approved systems, which includes sign stands and attachment hardware (nuts, bolts, clamps, brackets, braces, etc.), meeting the vendor requirements specified on the FDOT APL drawings.
- b) Provide Federal Highway Administration's (FHWA) accepted sign substrate for use with accepted sign stands on the National Highway System (NHS) under the provisions of the NCHRP Report 350 "Recommended Procedures for the Safety Performance Evaluation of Highway Features."

##### 3) Barrier Mounted Signs:

- a) When post mounting criteria cannot be achieved in accordance with FDOT Design Standards, Index No. 600 and a barrier or traffic railing exists, use temporary sign criteria provided in FDOT Design Standards, Index No. 11871.

3. Business Signs:
  - a. Provide and place signs in accordance with the Plans and FDOT Design Standards, Index No. 600 series. Furnish signs having retroreflective sheeting meeting the requirements of FDOT Section 990.
4. High Intensity Flashing Lights:
  - a. Furnish Type B lights in accordance with the Plans and FDOT Design Standards.
5. Warning/Channelizing Devices:
  - a. Furnish warning/channelizing devices in accordance with the Plans and FDOT Design Standards.
  - b. Retroreflective Collars for Traffic Cones:
    - 1) Use collars for traffic cones listed on the FDOT APL that meets the requirements of FDOT Section 990. Use cone collars at night designed to properly fit the taper of the cone when installed. Place the upper 6 inch collar a uniform 3-1/2 inches distance from the top of the cone and the lower 4 inch collar a uniform 2 inches distance below the bottom of the upper 6 inch collar. Ensure that the collars are capable of being removed for temporary use or attached permanently to the cone in accordance with the manufacturer's recommendations. Provide a white sheeting having a smooth outer surface and that has the property of a retroreflector over its entire surface.
  - c. Barrier Wall (Temporary):
    - 1) Furnish, install, maintain, remove and relocate a temporary barrier wall in accordance with the Plans. Ensure that temporary concrete barrier wall for use on roadway sections, complies with FDOT Design Standards, Index Nos. 412, 415 or 414 as specified in the Plans. Ensure that temporary concrete barrier wall for use on bridge and wall sections, complies with FDOT Design Standards, Index No 414 as specified in the Plans.
    - 2) Ensure that temporary water filled barrier wall used on roadway sections meets the NCHRP Report 350 criteria or the MASH and is listed on the FDOT APL. Barriers meeting the requirements of FDOT Design Standards, Index Nos. 412, 415 or temporary water filled barriers on the FDOT APL will not be accepted as an alternate to barriers meeting the requirements of FDOT Design Standards, Index No. 414.
    - 3) Trailer mounted barriers listed on the FDOT APL may be used at the option of the Contractor. Trailer mounted barriers listed on the FDOT APL must have an FHWA eligibility letter and be successfully crash tested in accordance with MASH TL-3 criteria. All trailer mounted barriers must be equipped with an FDOT APL listed truck mounted attenuator, an FDOT APL listed vehicle mounted arrow board and vehicle warning lights in accordance with this Article
    - 4) Temporary Barrier Wall Meeting the Requirements of Design Standards, Index Nos. 412 and 414:
      - a) Ensure the marking requirements of the respective Index are met.
- 5) Proprietary Precast Temporary Barrier Wall Fabricated prior to 2005:
  - a) Contractor must submit a certification stating that all unmarked barrier wall units meet the requirements of the Specifications and the FDOT Design Standards. Certifications will be project specific and non-transferable
- 6) Proprietary Precast Temporary Barrier Wall Fabricated in 2005 or later:
  - a) Ensure each wall unit has permanent clear markings, showing the manufacture date, serial number, manufacturer's name or symbol, and the FDOT APL number. Label the markings on a plate, plaque, or cast in the unit. Proprietary barrier wall fabricated prior to 2016 and marked with the "INDX 521" in lieu of the FDOT APL number will be permitted.
- 7) Glare Screen (Temporary):
  - a) Use temporary glare screens listed on the FDOT APL that meet the requirements of FDOT Section 990. Furnish, install, maintain, remove and relocate glare screen systems in conjunction with temporary barrier wall at locations identified in the Plans.
  - b) Ensure the anchorage of the glare screen to the barrier is capable of safely resisting an equivalent tensile load of 600 pounds per foot of glare screen, with a requirement to use a minimum of three fasteners per barrier section.
  - c) When glare screen is utilized on temporary barrier wall, warning lights will not be required.
- 8) Longitudinal Channelizing Devices (LCDs):
  - a) Furnish LCDs in accordance with the Plans and FDOT Design Standards. LCDs are categorized as vehicular or pedestrian and shall be interlocked. For LCDs requiring internal ballasting, an indicator that clearly identifies the proper ballast level will be required.
  - b) Use alternating orange and white pattern for solid color vehicular LCDs. Vehicular LCDs may be substituted for drums, vertical panels, or barricades.
6. Temporary Crash Cushion (Redirective/Gating):
  - a. Furnish, install, maintain and subsequently remove temporary crash cushions in accordance with the details and notes shown in the Plans, the FDOT Design Standards, and requirements of the pre-approved alternatives listed on the FDOT APL.
  - b. Maintain the crash cushions until their authorized removal. Repair all attachment scars to permanent structures and pavements after crash cushion removal. Make necessary repairs due to defective material, work, or Contractor operations at no cost to the Department.
  - c. Restore crash cushions damaged by the traveling public within 24 hours after notification as authorized by Engineer.
7. Guardrail (Temporary):

- a. Furnish guardrail (temporary) in accordance with the Plans and Design Standards. Meet the requirements of Article 536.
8. Arrow Board:
- a. Furnish arrow boards that meet the requirements of FDOT Section 990 as required by the Plans and Design Standards to advise approaching traffic of lane closures or shoulder work.
  - b. Type B arrow boards may be used on low to intermediate speed (0 mph to 50 mph) facilities or for maintenance or moving operations on any speed facility.
  - c. Type C arrow boards shall be used for all other operations on high-speed (50 mph and greater) facilities and may be substituted for Type B arrow boards on any speed facility.
9. Portable Changeable Message Sign (PCMS):
- a. Furnish PCMSs or truck mounted changeable message signs that meet the requirements of FDOT Section 990 as required by the Plans and FDOT Design Standards to supplement other temporary traffic control devices used in work zones.
10. Portable Regulatory Signs (PRS):
- a. Furnish PRSs that meet the requirements of FDOT Section 990 as required by the Plans and FDOT Design Standards.
  - b. Activate portable regulatory signs only during active work activities and deactivate when no work is being performed.
11. Radar Speed Display Unit (RSDU):
- a. Furnish RSDUs that meet the requirements of FDOT Section 990 as required by the Plans and FDOT Design Standards to inform motorists of the posted speed and their actual speed.
  - b. Activate the radar speed display unit only during active work activities and deactivate when no work is being performed.
12. Temporary Signalization and Maintenance:
- a. Provide temporary signalization and maintenance at existing, temporary, and new intersections including but not limited to the following:
    - 1) Installation of temporary poles and span wire assemblies as shown in the Plans,
    - 2) Temporary portable traffic signals as shown in the Plans,
    - 3) Adding or shifting signal heads,
    - 4) Trouble calls,
    - 5) Maintaining intersection and coordination timing and preemption devices.
  - b. Restore any loss of operation within 12 hours after notification.
  - c. Provide traffic signal equipment that meets the requirements of Article 603 of FDOT Design Standards. Engineer may approve used signal equipment if it is in acceptable condition. Replacement components for

traffic signal cabinet assemblies will be provided by the maintaining agency.

13. Temporary Traffic Detection and Maintenance:

- a. Provide temporary traffic detection and maintenance at existing, temporary, and new signalized intersections. Provide temporary traffic detection equipment listed on the FDOT APL. Restore any loss of detection within 12 hours. Ensure 90% accuracy per signal phase, measured at the initial installation and after any lane shifts, by comparing sample data collected from the detection system with ground truth data collected by human observation. Collect the sample and ground truth data for a minimum of five minutes during a peak and five minutes during an off-peak period with a minimum three detections for each signal phase. Perform the test in the presence of Engineer.

14. Truck Mounted Attenuators and Trailer Mounted Attenuators:

- a. Furnish, install and maintain only those attenuators that meet the requirements of NCHRP 350 or the MASH.
- b. Use truck mounted attenuators or trailer mounted attenuators, when called for in the FDOT Design Standards. Use attenuators listed on the FDOT APL.
- c. When attenuators are called for, use either a truck mounted attenuator or a trailer mounted attenuator system designed and installed in accordance with the manufacturers recommendations.
- d. Equip the attenuator cartridge with lights and reflectors in compliance with applicable Florida motor vehicle laws, including turn signals, dual tail lights, and brake lights. Ensure that lights are visible in both the raised and lowered positions if the unit is capable of being raised.
- e. Install either alternating black with yellow or white with orange sheeting on the rear of trailer mounted attenuators and on truck mounted attenuators, in both the operating and raised position. Use Type III (work zone) or Type IV sheeting consisting of 4 or 6 inch wide stripes installed to form chevrons that point upward. All sheeting except black shall be retroreflective.
- f. Attenuators will not be paid for separately. Include the cost of the truck with either a truck mounted attenuator or a trailer mounted attenuator under Maintenance of Traffic (General). Payment includes all costs, including furnishing, maintaining and removal when no longer required, and all materials, labor, tools, equipment and incidentals required for attenuator maintenance.

15. Temporary Raised Rumble Strip Sets:

- a. When called for in the Plans, furnish, install, maintain, remove, and reinstall temporary raised rumble strip sets.
- b. Install the temporary raised rumble strip sets per the manufacturer's recommendations and in accordance with FDOT Design Standards, Index No. 603.
- c. The temporary raised rumble strip may be either a removable polymer striping tape or a molded engineered polymer material.

16. Automated Flagger Assistance Devices (AFAD):

- a. Furnish, install, maintain, remove and relocate AFADs in accordance with the Plans and FDOT Design Standards. Position AFADs where they are clearly visible to oncoming traffic and out of the lane of traffic. The devices may be operated either by a single flagger at one end of the traffic control zone, from a central location, or by a separate flagger near each device's location.
- b. AFADs may be either a remotely controlled Stop/Slow AFAD mounted on either a trailer or a movable cart system, or a remotely controlled Red/Yellow Lens AFAD.
- c. AFADs will not be paid for separately. AFADs may be used as a supplement or an alternate to flaggers in accordance with FDOT Index 603. Include the cost for AFADs in Maintenance of Traffic (General).
- c. Retroreflectivity: Apply white and yellow traffic stripes and markings that will attain an initial retroreflectivity of not less than 300 mcd/lx·m<sup>2</sup> for white and contrast markings and not less than 250 mcd/lx·m<sup>2</sup> for yellow markings. Black portions of contrast tapes and black masking tapes must be non-reflective and have a reflectance of less than 5 mcd/lx m<sup>2</sup>. At the end of the six month service life, the retroreflectance of white and yellow removable tape shall not be less than 150 mcd/lx·m<sup>2</sup>.
- d. Removability: Provide removable tape capable of being removed from bituminous concrete and portland cement concrete pavement intact or in substantially large strips, either manually or by a mechanical roll-up device, at temperatures above 40°F, without the use of heat, solvents, grinding or blasting.

17. Temporary Lane Separator:

- a. Furnish, install, maintain, remove and relocate temporary lane separator in accordance with the Plans and FDOT Design Standards, Index No 600.
- b. Anchor the portable temporary lane separator with a removable anchor bolt. Use epoxy on bridge decks where anchoring is not allowed. Remove the epoxy from the bridge deck by hydroblasting or other method approved by Engineer.

- 4. Temporary Retroreflective Pavement Markers (RPM's): Use markers listed on the FDOT APL and meeting the requirements of FDOT 990-5. Apply all markers in accordance with the FDOT Design Standards, Index Nos. 600 and 17352, prior to opening the road to traffic. Replace markers any time after installation when more than three consecutive markers fail or are missing, at no expense to the Department, in a timely manner, as directed by Engineer.

J. Work Zone Pavement Marking.

K. Method of Measurement.

1. Description:

1. General:

- a. Furnish and install work zone pavement markings for MOT in construction areas and in close conformity with the lines and details shown in the Plans and FDOT Design Standards.
- b. Centerlines, lane lines, edge lines, stop bars and turn arrows will be required in work zones prior to opening the road to traffic.
- c. The most common types of work zone pavement markings are painted pavement markings and removable tape. Other types of work zone pavement markings may be identified in the Plans.

- a. Devices installed/used on the Project on any calendar day or portion thereof, within the allowable Contract Time, including time extensions which may be granted, will be paid for at the Contract unit price for the applicable pay item, except those paid for as Maintenance of Traffic (General).
- b. One or more of the following items may appear in a contract in addition to a direct payment item for Maintenance of Traffic (Lump Sum). Unless otherwise stipulated in the Contract Documents, only those items with an Awarded Unit Price will be considered for direct payment.

2. Painted Pavement Markings:

2. Traffic Control Officers:

- a. General: Use painted pavement markings meeting the requirements of Article 710. Use standard waterborne paint unless otherwise identified in the Plans or approved by Engineer.

- a. The County will reimburse Contractor for the services of uniformed law enforcement officers authorized to serve as traffic control officers for the purpose of controlling or directing traffic in the work zone as part of the County approved Traffic Control Plan and Maintenance of Traffic provided by Contractor pursuant to the Contract Documents.
- b. The quantity to be paid for will be the invoice unit price per hour for the actual number of officers certified to be on the project site, including any law enforcement vehicles and all other direct and indirect costs.
- c. Payment will be made at invoice cost from an appropriate dedicated allowance established by the County.
- d. Payment will be made only for those Traffic Control Officers specified in the Plans and authorized by the Engineer. The necessary invoices and documentation must be submitted to the Engineer along with the payment request.

3. Removable Tape:

- a. General: Use removable tape listed on the FDOT APL and meeting the requirements of FDOT 990-4.
- b. Application: Apply removable tape with a mechanical applicator to provide pavement lines that are neat, accurate and uniform. Equip the mechanical applicator with a film cut-off device and with measuring devices that automatically and accumulatively measure the length of each line placed within an accuracy tolerance of plus or minus 2%. Ensure removable tape adheres to the road surface. Removable tape may be placed by hand on short sections, 500 feet or less, if it is done in a neat accurate manner.

### 3. Special Detours:

- a. When a detour facility is specifically detailed in the Plans, or is otherwise described or detailed as a special item, and an item for separate payment is included in the proposal, the work of constructing, maintaining, and subsequently removing such detour facilities will be paid for separately. Traffic control devices, warning devices, barriers, signing, and pavement markings for special detours will also be paid for separately.
- b. When the Plans show more than one detour, each detour will be paid for separately, at the Contract lump sum price for each.
- c. Where a separate item for a specific detour facility is included in the proposal, payment will be made under special detour.

### 4. Commercial Material for Driveway Maintenance:

- a. The quantity to be paid for will be the certified volume, in cubic yards, of all materials authorized by the Engineer, acceptably placed, compacted and maintained for driveway maintenance. The volume, which is authorized to be reused, and which is acceptably salvaged, placed, compacted and maintained in other designated driveways will be included again for payment.
- b. Arrow Board: The quantity to be paid at the contract unit price will be for the number of arrow boards certified as installed/used on the project on any calendar day or portion thereof within the contract time.

### 5. Work Zone Signs:

- a. The number of temporary post-mounted signs (temporary regulatory, warning and guide) certified as installed/used on the project will be paid for at the Contract unit price for work zone signs. When multiple signs are located on single or multiple posts, each sign panel will be paid individually. Signs greater than 20 square feet and detailed in the Plans will be paid for under Maintenance of Traffic (General).
- b. Temporary portable signs (excluding mesh signs) and vehicular mounted signs will be included for payment under work zone signs, only if used in accordance with the FDOT Design Standards.
- c. The number of temporary barrier mounted signs (temporary regulatory, warning and guide) certified as installed/used on the project will be paid for at the Contract unit price for barrier mounted work zone signs.

### 6. Business Signs:

- a. The number of business signs certified as installed/used on the project will be paid for at the Contract unit price for business signs.

### 7. High Intensity Flashing Lights:

- a. The number of high intensity flashing lights (Type B) certified as installed/used on the project will be paid for at the Contract unit price for high intensity flashing lights (temporary - Type B).

### 8. Channelizing Devices:

- a. The number of drums, vertical panels, pedestrian LCDs, and Type I, Type II, Type III, or direction indicator barricades, certified as installed/used on the project

meeting the requirements of FDOT Design Standards, Index No. 600 and have been properly maintained will be paid for at the Contract unit prices for channelizing device.

- b. Payment for vehicular LCDs will be paid as the length in feet installed divided by the device spacing for barricades, vertical panels, and drums and certified as installed/used on the project meeting the requirements of FDOT Design Standards, Index No. 600 and have been properly maintained will be paid for at the Contract unit price for channelizing device.
- c. Payment will not be made for channelizing devices unsatisfactorily maintained, as determined by the Engineer.
- d. Payment will be made for each channelizing device that is used to delineate trailer mounted devices.
- e. Payment will be made for channelizing devices delineating portable changeable message signs during the period beginning 14 working days before Contract Time begins as authorized by the Engineer.

### 9. Barrier Wall (Temporary):

- a. The Contract unit price for barrier wall (temporary) will be full compensation for furnishing, installing, maintaining, and removing the barrier wall. When called for, the Contract unit price for barrier wall (temporary/relocate) will be full compensation for relocating the barrier. The certified quantity to be paid for will be determined by the number of sections times the nominal length of each section.

### 10. Barrier Delineators:

- a. The number of barrier delineators, installed on top of barrier wall, used on the project, meeting the requirements of FDOT Design Standards and Article 705.

### 11. Lights, Temporary, Barrier Wall Mount:

- a. The number of Type C steady burn lights, mounted on barrier wall, certified as installed/used on the project, meeting the requirements of the Design Standards and have been properly maintained will be paid for at the Contract unit price for lights temporary, barrier wall mount.

### 12. Glare Screen (Temporary):

- a. The certified quantity to be paid for will be determined by the number of sections times the nominal length of each section.

### 13. Temporary Crash Cushions:

#### a. Redirective:

- 1) The quantity to be paid for will be the number of temporary crash cushions (redirective) certified as installed/used and maintained on the project, including object marker.

#### b. Gating:

- 1) The quantity to be paid for will be the number of temporary crash cushions (gating) certified as installed/used and maintained on the project, including object marker.

14. Temporary Guardrail:

- a. The quantity to be paid for will be the length, in feet, of temporary guardrail constructed and certified as installed/used on the project. The length of a run of guardrail will be determined as a multiple of the nominal panel lengths.

15. Arrow Board:

- a. The quantity to be paid at the Contract unit price will be for the number of arrow boards certified as installed/used on the project on any calendar day or portion thereof within the Contract time.

16. Portable Changeable Message Sign:

- a. The quantity to be paid at the Contract unit price will be for the number of portable changeable message signs or truck mounted changeable message signs certified as installed/used on the project on any calendar day or portion thereof within the Contract time.
- b. Payment will be made for each portable changeable message sign that is used during the period beginning fourteen working days before Contract Time begins as authorized by Engineer.

17. Portable Regulatory Signs:

- a. The quantity to be paid for will be the number of portable regulatory signs certified as installed/used on the project on any calendar day or portion thereof within the Contract time, will be paid for the Contract unit price for portable regulatory sign.

18. Radar Speed Display Unit:

- a. The quantity to be paid for will be the number of radar speed display units certified as installed/used on the project on any calendar day or portion thereof within the Contract Time, will be paid for the Contract unit price for radar speed display unit.

19. Temporary Signalization and Maintenance:

- a. For existing intersections, the quantity to be paid for will be the number of signalized intersections per day for the full duration of the Contract. For temporary intersections, the quantity to be paid for will be the number of signalized intersections per day for the duration of the temporary intersection. No separate payment will be made for temporary signalization and maintenance at new intersections.

20. Temporary Traffic Detection and Maintenance:

- a. For existing intersections, the quantity to be paid for will be the number of signalized intersections per day beginning the day Contract Time begins and ending the day the permanent detection is operational and the final lane configuration is in place. For temporary and new intersections, the quantity to be paid for will be the number of signalized intersections per day beginning the day the temporary detection is functional and ending the day the permanent detection is operational and the final lane configuration is in place for a new intersection; or, when the detection is removed for a temporary intersection.

21. Work Zone Pavement Markings:

- a. The quantities, furnished and installed, to be paid for will be the length of skip and solid pavement markings, and the area of pavement markings placed as follows:

- 1) The total transverse distance, in feet, of skip pavement marking authorized and acceptably applied. The length of actual applied line will depend on the skip ratio of the material used. Measurement will be the distance from the beginning of the first stripe to the end of the last stripe with proper deductions made for unpainted intervals as determined by plan dimensions or stations, subject to the requirements of the Contract Documents.
- 2) The net length, in feet, of solid pavement marking authorized and acceptably applied.
- 3) The number of directional arrows or pavement messages authorized and acceptably applied.
- 4) The number of temporary RPM's authorized and acceptably applied.

22. Temporary Raised Rumble Strips:

- a. The quantity to be paid for will be the number of temporary raised rumble strip sets certified as installed/used on the project on any calendar day or portion thereof within the Contract Time.
- b. The number of strips used must meet the requirements of FDOT Design Standards, Index No. 603. No adjustment will be made to the per day measurement for the number of strips or sets used, or for the number of times the sets are relocated.

23. Temporary Lane Separator:

- a. The quantity of temporary lane separator to be paid for will be plan quantity, in feet, including drainage gaps, completed and accepted.

L. Submittals.

1. Submittal Instructions:

- a. Prepare a certification of quantities for certified MOT payment items for each project in the Contract. Submit the certification of quantities to Engineer. The Department will not pay for any disputed items until Engineer approves the certification of quantities.

2. Contractor's Certification of Quantities:

- a. Request payment by submitting a certification of quantities as directed by Engineer, based on the amount of work done or completed. Ensure the certification consists of the following:
- b. Contract Number, Certification Date and the period that the certification represents.
- c. The basis for arriving at the amount of the progress certification, less payments previously made and less an amount previously retained or withheld. The basis will include a detail breakdown provided on the certification of items of payment in accordance with 102-M. After the initial setup of the MOT items and counts, the interval for recording the counts will be made weekly on the certification sheet unless there is a change. This change will be documented on the day

of occurrence. Some items may necessitate a daily interval of recording the counts.

M. Basis of Payment.

1. Maintenance of Traffic (General):

- a. No Direct Payment Provided: When no item for direct payment of Maintenance of Traffic (Lump Sum) is provided by the Contract, the costs for performing all work and requirements specified under this Article, except as may be specifically covered for payment under other items, will be included among the various scheduled items of the Contract.
- b. Direct Payment Provided: When direct payment for Maintenance of Traffic (Lump Sum) is provided in the Contract, the quantity to be paid all work and costs specified under this Article, except as may be specifically covered for payment under other items, will be the lump sum Contract Price.

2. Additional items of Direct Payment. Only those items with an Awarded Unit Price will be considered for direct payment.

a. Traffic Control Officers:

- 1) Price and payment will be full compensation for the services of the traffic control officers at invoice cost as specified under subarticle 102.K.2 above.

b. Special Detours:

- 1) Price and payment will be full compensation for providing all detour facilities shown in the Plans and all costs incurred in carrying out all requirements of this Article for general MOT within the limits of the detour, as shown in the Plans.

c. Commercial Materials for Driveway Maintenance:

- 1) Price and payment will be full compensation for all work and materials specified for this item, including specifically all required shaping and maintaining of driveways.

d. Work Zone Signs:

- 1) Price and payment will be full compensation for all work and materials for furnishing signs, supports and necessary hardware, installation, relocating, maintaining and removing signs.

e. Business Signs:

- 1) Price and payment will be full compensation for all materials and labor required for furnishing, installing, relocating, maintaining, and removing the signs as well as the cost of installing any logos provided by business owners.

f. High Intensity Warning Lights:

- 1) Price and payment will be full compensation for furnishing, installing, operating, relocating, maintaining and removing high intensity flashing lights (Type B).

g. Channelizing Devices:

- 1) Prices and payment will be full compensation for furnishing, installing, relocating, maintaining and

removing the channelizing devices, including the costs associated with attached warning lights as required.

h. Barrier Wall (Temporary):

- 1) Price and payment will be full compensation for furnishing, installing, maintaining, and removing the barrier. When called for, barrier wall (temporary) (relocate) will be full compensation for relocating the barrier.

i. Lights, Temporary, Barrier Wall Mount:

- 1) Price and payment will be full compensation for all work and materials for furnishing, installing and maintaining the warning lights mounted on barrier wall. Payment will not be made for lights that are improperly placed or are not working.

j. Barrier Delineators:

- 1) No separate payment will be made for barrier delineators installed on top of temporary barrier wall. The cost of furnishing, installing and maintaining the barrier delineators will be included in the cost of the temporary barrier wall.

k. Glare Screen (Temporary):

- 1) Price and payment will be full compensation for furnishing, installing, maintaining, and removing the glare screen certified as installed/used on the project. When called for, glare screen (relocate) will be full compensation for relocating the glare screen.

l. Temporary Crash Cushion (Redirective/Gating):

- 1) Price and payment will be full compensation for furnishing, installing, maintaining and subsequently removing such crash cushions. Payment for restoring damaged crash cushions will be the manufacturer's/distributor's invoice price for the new materials/parts plus 20% markup. The 20% markup is compensation for all necessary work including; but not limited to, labor, equipment, supplies and profit, as authorized by Engineer. Additional MOT required for the repair of the crash cushion will be paid for under the appropriate MOT pay item.

m. Temporary Guardrail:

- 1) Price and payment will be full compensation for furnishing all materials required for a complete installation, including end anchorage assemblies and any end connections to other structures and for installing, maintaining and removing guardrail.

n. Arrow Board:

- 1) Price and payment will be full compensation for furnishing, installing, operating, relocating, maintaining and removing arrow boards.

o. Portable Changeable Message Sign:

- 1) Price and payment will be full compensation for furnishing, installing, operating, relocating, maintaining and removing portable changeable message signs.

p. Portable Regulatory Signs:



- 1) Price and payment will be full compensation for furnishing, installing, relocating, maintaining and removing a completely functioning system as described in these Specifications portable regulatory signs. Price and payment will be full compensation for furnishing, installing, operating, relocating, maintaining and removing portable regulatory signs.
- 2) Payment will include all labor, materials, incidentals, repairs and any actions necessary to operate and maintain the unit at all times that work is being performed or traffic is being affected by construction and/or MOT operations.

q. Radar Speed Display Unit:

- 1) Price and payment will be made only for a completely functioning system as described in these specifications. Payment will include all labor, hardware, accessories, signs, and incidental items necessary for a complete system.
- 2) Payment will include any measurements needed to insure that the unit conforms to all specification requirements.
- 3) Payment will include all labor, materials, incidentals, repairs and any actions necessary to operate and maintain the unit at all times that work is being performed or traffic is being affected by construction and/or MOT operations. Price and payment will be full compensation for furnishing, installing, operating, relocating, maintaining and removing radar speed display unit.

r. Temporary Signalization and Maintenance:

- 1) Price and payment will constitute full compensation for furnishing, installing, operating, maintaining and removing temporary traffic control signals including all equipment and components necessary to provide an operable traffic signal. Payment will be withheld for each day at each intersection where the temporary signalization is not operational within 12 hours after notification.

s. Temporary Traffic Detection and Maintenance:

- 1) Price and payment will constitute full compensation for furnishing, installing, operating, maintaining and removing temporary traffic detection including all equipment and components necessary to provide an acceptable signalized intersection. Take ownership of all equipment and components. Payment will be withheld for each day at each intersection where the temporary detection is not operational within 12 hours after notification.

t. Temporary Raised Rumble Strips:

- 1) Price and payment will be full compensation for all work and materials described in this Article, including all cleaning and preparing of surfaces, disposal of all debris, furnishing of all materials, application, curing, removal, reinstalling and protection of all items, protection of traffic, furnishing of all tools, machines and equipment, and all incidentals necessary to complete the work.

u. Work Zone Pavement Markings:

- 1) Price and payment will be full compensation for all work specified including, all cleaning and preparing of surfaces, furnishing of all materials, application, curing and protection of all items, protection of traffic, furnishing of all tools, machines and equipment, and all incidentals necessary to complete the work. Final payment will be withheld until all deficiencies are corrected.
- 2) Removable tape may be substituted for work zone paint at no additional cost to the Department.
- 3) Payment for temporary RPMs used to supplement line markings will be paid for under temporary retroreflective pavement markers. Install these markers as detailed in the Design Standards.

v. Temporary Lane Separator:

- 1) Price and payment will be full compensation for all work specified in this Article.

3. Payment Items: Payment will be made under:

Item No.	Description	Unit
102- 1A	Maintenance of Traffic	LS

**104 PREVENTION, CONTROL, AND ABATEMENT OF EROSION AND WATER POLLUTION (REV. 01-09-12)**

A. Description.

1. Provide erosion control measures on the Project and in areas outside the right-of-way where work is accomplished in conjunction with the Project, so as to prevent pollution of water, detrimental effects to public or private property adjacent to the Project right-of-way, and damage to work on the Project.
2. Construct and maintain temporary erosion control features and, as required, construct and maintain permanent erosion control features as shown in the Plans or as may be directed by Engineer.

B. General.

1. Coordinate the installation of temporary erosion control features with the construction of the permanent erosion control features to the extent necessary to ensure economical, effective, and continuous control of erosion and water pollution throughout the life of the Contract.
2. Maintain, at the work site, copies of all documents referenced by this Specification including: the Departmental Stormwater Pollution Prevention Plan (if provided); the approved contractor Erosion Control Plan; and applicable inspection reports, permits and certifications. Document compliance with all requirements pertaining to the aforementioned documents and this Specification.
3. Engineer may direct, when warranted by unforeseen conditions, the use of control features or methods other than those included in the original Contract. In such event, the Department will pay for this additional work as unforeseeable work.

C. Control of Contractor's Operations Which May Result in Water Pollution.

1. Prevent pollution of streams, canals, lakes, reservoirs, and other water impoundments with fuels, oils, bitumens, calcium chloride, or other harmful materials.
2. Conduct and schedule operations to avoid or otherwise minimize pollution or siltation of such water impoundments, and to avoid interference with movement of migratory fish. Do not dump any residue from dust collectors or washers into any water body.
3. Restrict construction operations in rivers, streams, lakes, tidal waters, reservoirs, canals, and other water impoundments to those areas where it is necessary to perform filling or excavation to accomplish the work shown in the Plans and to those areas which must be entered to construct temporary or permanent structures. As soon as conditions permit, promptly clear rivers, streams, and impoundments of all obstructions placed therein or caused by construction operations.
4. Do not frequently ford live streams with construction equipment. Wherever an appreciable number of stream crossings are necessary at any one location, use a temporary bridge or other structure.
5. Except as necessary and authorized for Project construction, do not deposit excavated material in rivers, streams, canals, or impoundments, or in a position close enough thereto, to be washed away by high water or runoff.
6. Where pumps are authorized for use in removing highly turbid waters from enclosed construction areas such as cofferdams or forms, treat the water by one or more of the following methods prior to discharge into State waters:
  - a. Pumping into grassed swales or appropriate vegetated areas or sediment basins.
  - b. Confined by an appropriate enclosure such as turbidity barriers when other methods are not considered appropriate.
7. Do not disturb lands or waters outside the limits of construction as staked, except as authorized by Engineer.
8. Obtain Engineer's approval for the location of, and method of operation in, borrow pits, material pits, and disposal areas furnished for waste material from the project (other than commercially operated sources) such that erosion during and after completion of the work will not result in probability of detrimental siltation or water pollution.

D. Materials for Temporary Erosion Control.

1. Engineer will not require testing of materials used in construction of temporary erosion control features other than as provided for geotextile fabric in FDOT 985-3 unless such material is to be incorporated into the completed Project.
2. When no testing is required, Engineer will base acceptance on visual inspection.
3. Contractor may use new or used materials, subject to Engineer's approval, for the construction of temporary silt

fence, staked turbidity barriers, and floating turbidity barrier not to be incorporated into the completed Project.

E. Erosion Control Plan.

1. Prepare the Erosion Control Plan (ECP) in a format acceptable to the Department and in accordance with the planned sequence of operations.
2. At the Preconstruction Conference, submit to the Department an ECP that:
  - a. Meets the requirements or conditions of all permits authorizing construction of the Project. Where no permits are required or the approved permits do not contain conditions that specifically addresses erosion and water pollution, the requirements of the ECP will be governed by the Contract Documents and all applicable laws, rules, or regulations.
  - b. Accompanies the Department's Stormwater Pollution Prevention Plan (SWPPP) when a SWPPP is provided for the Project.
  - c. Includes and describes for each phase of construction operations or activities the following:
    - 1) Locations of all erosion control devices
    - 2) Types of all erosion control devices
    - 3) Estimated time erosion control devices will be in operation
    - 4) Monitoring schedules for maintenance of erosion control devices
    - 5) Methods of maintaining erosion control devices
    - 6) Containment or removal methods for pollutants or hazardous wastes
    - 7) The name and telephone number of the person responsible for monitoring and maintaining the erosion control devices.
  - d. Includes procedures to control off-site tracking of soil by vehicles and construction equipment and a procedure for cleanup and reporting of non-stormwater discharges.
  - e. Describes all phases of operations, the prevention, control, and abatement of erosion and water pollution items or activities necessary for the Project, to include:
    - 1) Types and locations of all erosion control devices
    - 2) Estimated time erosion control devices will be in operation
    - 3) Monitoring schedules for maintenance of erosion control devices
    - 4) Methods for maintaining erosion control devices
    - 5) Containment or removal methods for pollution or hazardous wastes
    - 6) Name and telephone number of the person responsible for monitoring and maintaining the erosion control devices.
3. Contractor must obtain Engineer's written approval of the ECP prior to commencing any construction activities.

4. For project requiring a Florida Department of Environmental Protection (FDEP) Generic Permit for Stormwater Discharge from Large and Small Construction Activities (Generic Permit):
  - a. Failure to sign any documents or certification statements required by the FDEP Generic Permit will be considered a default of the Contract.
  - b. Any soil disturbing activities performed without the required signed documents or certifications statements may be considered a violation of the FDEP Generic Permit.
- c. At sites where exposure to such sensitive areas is prevalent, complete the installation of any sediment control device prior to the commencement of any earthwork.
- d. After installation of sediment control devices, repair portions of any devices damaged at no expense to the Department. Engineer may authorize temporary erosion and sediment control features when finished soil layer is specified in the Contract and the limited availability of that material from the grading operations will prevent scheduled progress of the work or damage the permanent erosion control features.

F. Construction Requirements.

1. Limitation of Exposure of Erodible Earth:
  - a. Engineer may limit the surface areas of unprotected erodible earth exposed by the construction operation and may direct Contractor to provide erosion or pollution control measures to prevent contamination of any river, stream, lake, tidal waters, reservoir, canal, or other water impoundments or to prevent detrimental effects on property outside the Project right-of-way or damage to the Project.
  - b. Limit the area in which excavation and filling operations are being performed so that it does not exceed the capacity to keep the finish grading, turf, sod, and other such permanent erosion control measures current in accordance with the accepted schedule.
  - c. Do not allow the surface area of erodible earth that clearing and grubbing operations or excavation and filling operations expose to exceed 750,000 square feet without specific prior approval by Engineer. This limitation applies separately to clearing and grubbing operations and excavation and filling operations.
  - d. Engineer may increase or decrease the amount of surface area the Contractor may expose at any one time.
2. Incorporation of Erosion and Sediment Control Features:
  - a. Incorporate permanent erosion control features into the project at the earliest practical time. Use temporary erosion and sediment control features found in the State of Florida Erosion and Sediment Control Designer and Reviewer Manual (E&SC Manual) to correct conditions that develop during construction which were not foreseen at the time of design, to control erosion and sediment prior to the time it is practical to construct permanent control features, or to provide immediate temporary control of erosion and sediment that develops during normal construction operations, which are not associated with permanent erosion control features on the project. An electronic version of the E&SC Manual can be found at the following URL: <http://www.dot.state.fl.us/specificationoffice/Implemented/URLinSpecs/Files/FLEROSIONSEDIMENTMANUAL060709.pdf>
  - b. Install all sediment control devices in a timely manner to ensure the control of sediment and the protection of lakes, streams, gulf or ocean waters, or any wetlands associated therewith and to any adjacent property outside the right-of-way as required.
3. Scheduling of Successive Operations:
  - a. Schedule operations such that the area of unprotected erodible earth exposed at any one time is not larger than the minimum area necessary for efficient construction operations, and the duration of exposure of uncompleted construction to the elements is as short as practicable.
  - b. Schedule and perform clearing and grubbing so that grading operations can follow immediately thereafter. Schedule and perform grading operations so that permanent erosion control features can follow immediately thereafter if conditions on the project permit.
4. Details for Temporary Erosion and Sediment Control Features:
  - a. General: Use temporary erosion, sediment and water pollution control features found in the E&SC Manual. These features consist of, but are not limited to, temporary turf, rolled erosion control products, sediment containment systems, runoff control structures, sediment barriers, inlet protection systems, silt fences, and turbidity barriers. For design details for some of these items, refer to the Plans, the FDOT Design Standards and E&SC Manual.
  - b. Temporary Sod: Engineer may designate certain areas of sod constructed in accordance with the Specifications as temporary erosion control features. For areas not defined as sod, constructing temporary turf by seeding only is not an option for temporary erosion control under this Article. Engineer may waive the turf establishment requirements of the Specifications for areas with temporary sod that will not be a part of the permanent construction. The work of placing temporary sod, approved as a temporary erosion control feature where directed by Engineer and in accordance with these Specifications, will be paid for as unforeseeable work.
  - c. Runoff Control Structures: Construct runoff control structures in accordance with the details shown in the Plans, the E&SC Manual, or as may be approved as suitable to adequately perform the intended function.
  - d. Sediment Containment Systems: Construct sediment containment systems in accordance with the details shown in the Plans, the E&SC Manual, or as may be approved as suitable to adequately perform the intended function. Clean out sediment containment systems as necessary in accordance with the Plans or as directed.
  - e. Sediment Barriers: Provide and install sediment barriers according to details shown in the Plans, as

directed by Engineer, or as shown in the E&SC Manual to protect against downstream accumulation of sediment. Sediment Barriers include, but are not limited to synthetic bales, silt fence, fiber logs and geosynthetic barriers. Reusable barriers that have had sediment deposits removed may be reinstalled on the Project as approved by Engineer.

f. Silt Fence:

- 1) General: Furnish, install, maintain, and remove silt fences, in accordance with the manufacturer's directions, these Specifications, the details as shown on the Plans, the FDOT Design Standards, and the E&SC Manual.
- 2) Materials and Installation: Use a geotextile fabric made from woven or nonwoven fabric, meeting the physical requirements of FDOT Section 985 according to those applications for erosion control. Choose the type and size of posts, wire mesh reinforcement (if required), and method of installation. Do not use products which have a separate layer of plastic mesh or netting. Provide a durable and effective silt fence that controls sediment comparable to the FDOT Design Standards and the E&SC Manual. Erect silt fence at upland locations, across ditch lines and at temporary locations shown on the plans or approved by Engineer where continuous construction activities change the natural contour and drainage runoff. Do not attach silt fence to existing trees unless approved by Engineer.
- 3) Inspection and Maintenance: Inspect all silt fences immediately after each rainfall and at least daily during prolonged rainfall. Immediately correct any deficiencies. In addition, make a daily review of the location of silt fences in areas where construction activities have changed the natural contour and drainage runoff to ensure that the silt fences are properly located for effectiveness. Where deficiencies exist, install additional silt fences as directed by Engineer. Remove sediment deposits when the deposit reaches approximately 1/2 of the volume capacity of the silt fence or as directed by Engineer. Dress any sediment deposits remaining in place after the silt fence is no longer required to conform with the finished grade, and prepare them in accordance with the Contract Documents and as directed by Engineer.

g. Floating Turbidity Barriers and Staked Turbidity Barriers:

- 1) Install, maintain, and remove turbidity barriers to contain turbidity that may occur as the result of dredging, filling, or other construction activities which may cause turbidity to occur in the waters of the State. Contractor may need to deploy turbidity barriers around isolated areas of concern such as seagrass beds, coral communities, etc. both within as well as outside the right-of-way limits. Engineer will identify such areas. Place the barriers prior to the commencement of any work that could impact the area of concern. Install the barriers in accordance with the details shown in the Plans or as approved by Engineer. Ensure that the type

barrier used and the deployment and maintenance of the barrier will minimize dispersion of turbid waters from the construction site. Engineer may approve alternate methods or materials.

- 2) Operate turbidity barriers in such a manner to avoid or minimize the degradation of the water quality of the surrounding waters and minimize damage to areas where floating barriers installed.

h. Inlet Protection System: Furnish and install inlet protection systems as shown in the Plans, FDOT Design Standards and the E&SC Manual.

i. Rolled Erosion Control Products (RECPs):

- 1) General: Install RECPs in locations where temporary protection from erosion is needed. Two situations occur that require artificial coverings each having differing material requirements.

a) Temporary pauses in construction: Use RECPs composed of natural or synthetic fiber mats, plastic sheeting, or netting as protection against erosion, when directed by Engineer, during temporary pauses in construction caused by inclement weather or other circumstances. Remove the material when construction resumes.

b) Facilitating plant growth: Use RECPs as erosion control blankets, at locations shown in the plans, to facilitate plant growth while permanent grassing is being established. For the purpose described, use non-toxic, biodegradable, natural or synthetic woven fiber mats. Install erosion control blankets capable of sustaining a maximum design velocity of 6.5 ft/sec as determined from tests performed by Utah State University, Texas Transportation Institute or an independent testing laboratory approved by the Department. Furnish to Engineer, two certified copies of manufacturers test reports showing that the erosion control blankets meet the requirements of this Specification. Certification must be attested, by a person having legal authority to bind the manufacturing company. Also, furnish two 4 by 8 inch samples for product identification. The manufacturers test records shall be made available to the Department upon request. Leave the material in place, as installed, to biodegrade.

5. Removal of Temporary Erosion Control Features: In general, remove or incorporate into the soil any temporary erosion control features existing at the time of construction of the permanent erosion control features in an area of the Project in such a manner that no detrimental effect will result. Engineer may direct that temporary features be left in place.

G. Maintenance of Erosion and Sediment Control Features.

1. General: Provide routine maintenance of permanent and temporary erosion and sediment control features, at no expense to the Department, until the Project is complete and accepted. If reconstruction of such erosion and sediment control features is necessary due to Contractor's negligence or carelessness or, in the case of

temporary erosion and sediment control features, failure by the Contractor to install permanent erosion control features as scheduled, Contractor must replace such erosion control features at no expense to the Department. If reconstruction of permanent or temporary erosion and sediment control features is necessary due to factors beyond the control of Contractor, the Department will pay for replacement under the appropriate Contract pay item or items.

2. Inspect all erosion and sediment control features at least once every seven calendar days and within 24 hours of the end of a storm of 0.50 inches or greater. Maintain all erosion control features as required in the SWPPP, Contractor's ECP, the E&SC Manual, and as specified in the State of Florida Department of Environmental Protection Generic Permit for Stormwater Discharge from Large and Small Construction Activities.

H. Protection During Suspension of Contract Time.

1. If it is necessary to suspend the construction operations for any appreciable length of time, shape the top of the earthwork in such a manner to permit runoff of rainwater, and construct earth berms along the top edges of embankments to intercept runoff water. Provide temporary slope drains to carry runoff from cuts and embankments that are in the vicinity of rivers, streams, canals, lakes, and impoundments. Locate slope drains at intervals of approximately 500 feet, and stabilize them by paving or by covering with waterproof materials. Should such preventive measures fail, immediately take such other action as necessary to effectively prevent erosion and siltation. Engineer may direct Contractor to perform, during such suspensions of operations, any other erosion and sediment control work deemed necessary.

I. Method of Measurement.

1. Direct Payment Provided:

a. When separate items for temporary erosion control features are included in the Contract and have awarded Contract prices, the quantities to be paid for will be the:

- 1) Area, in square yards, of Rolled Erosion Control Products.
- 2) Length, in feet, of Runoff Control Structures, measured along the surface of the work constructed.
- 3) Number of Sediment Containment Systems constructed and accepted.
- 4) Number of Sediment Containment System Cleanouts accomplished and accepted.
- 5) Length, in feet, of Sediment Barriers.
- 6) Length, in feet, of Floating Turbidity Barrier.
- 7) Length, in feet, of Staked Turbidity Barrier.
- 8) Number of inlet protection systems.

b. Upon acceptance by the Engineer, the quantity of floating turbidity barriers, sediment barriers, staked turbidity barriers, and inlet protection devices will be paid for regardless of whether materials are new, used,

or relocated from a previous approved installation on the Project.

2. No Direct Payment Provided: Unless otherwise specified, when no item for direct payment of temporary erosion control features is provided by the Contract, the costs for performing all work and meeting the requirements of this Article will be included among the various scheduled items of the Contract.

J. Basis of Payment.

1. Prices and payments will be full compensation for all work specified in this Article, including construction and routine maintenance of temporary erosion control features.
2. Any additional costs resulting from compliance with the requirements of this Article, other than construction, routine maintenance, and removal of temporary erosion control features, will be included in the Contract unit prices for the item or items to which such costs are related.
3. Separate payment will not be made for the cost of constructing temporary earth berms along the edges of the roadways to prevent erosion during grading and subsequent operations. Contractor must include these costs in the Contract prices for earthwork items.
4. Additional temporary erosion control features constructed as directed by Engineer will be paid for as unforeseeable work.
5. In case of repeated failure on the part of Contractor to control erosion, pollution, or siltation, Engineer reserves the right to employ outside assistance or to use the Department's own forces to provide the necessary corrective measures. Any such costs incurred, including engineering costs, will be charged to Contractor and appropriate deductions made from the monthly progress estimate.

6. Payment Items: Payment will be made under:

Item No.	Description	Unit
104-18	Inlet Protection System	EA

**105 CONTRACTOR QUALITY CONTROL GENERAL REQUIREMENTS (REV. 08-23-12)**

A. General.

1. Submit to Engineer a Contractor's Quality Control Plan (CQCP) meeting the requirements stipulated in this Article and that addresses the transportation, storage, placement, sampling, inspection of Contract materials and related construction operations; and to ensure that all work and material incorporated into the Project meet the requirements of the Contract Documents.
2. Comply with all personnel qualification requirements stipulated in this Article and elsewhere in the Contract Documents.
3. When applies use the Laboratory Information Management System (LIMS) from FDOT as part of the

requirements for this Local Agency Program (LAP) contract.

- a. LIMS is a data management computer program which is used to report the sampling, testing and business decisions related to the Florida Department of Transportation's Quality Assurance Program.
- b. The Laboratory Information Systems Unit works closely with the LIMS Steering Committee and State Materials Office Information Technology staff to oversee the operational health of LIMS. The unit also manages those resources required for maintenance or enhancement of the LIMS application. Additional information can be found at <http://www.dot.state.fl.us/statematerialsoffice/laboratory/lims/index.shtm>.

#### B. Guidelines for Development of the CQCP

1. Use the following guidelines for developing the CQCP and include other additional items as necessary.
  - a. General. Provide detailed policies, methods and procedures to ensure the specified quality of all applicable materials and related production and field operations.
  - b. Process control testing. List the material to be tested by pay item, tests to be conducted, the location of sampling, and the frequency of testing.
  - c. Inspection/control procedures. Address each of the following subjects in each phase of construction:
    - 1) Preparatory phase.
      - a) Review all Contract requirements.
      - b) Ensure compliance of component material to the Contract requirements.
      - c) Coordinate all submittals including certifications.
      - d) Ensure capability of equipment and personnel to comply with the Contract requirements.
      - e) Ensure preliminary testing is accomplished.
      - f) Coordinate surveying and staking of the work.
    - 2) Start-up phase.
      - a) Review the Contract requirements with personnel performing the work.
      - b) Inspect start-up of work.
      - c) Establish standards of workmanship.
      - d) Provide training as necessary.
      - e) Establish detailed testing schedule based on the production schedule.
    - 3) Production phase.
      - a) Conduct intermittent or continuous inspection during construction to identify and correct deficiencies.
      - b) Inspect completed work before requesting Engineer inspection acceptance.
      - c) Provide feedback and system changes to prevent repeated deficiencies.
  - d. Description of records. List the records to be maintained.

#### e. Personnel qualifications.

- 1) Identify the primary contact that will communicate with the Department. Identify roles and responsibilities of the personnel involved in the Quality Control (QC) process. Document the name, authority, relevant experience, and qualifications of person with overall responsibility for the inspection system.
- 2) Document the names, authority, and relevant experience of all personnel directly responsible for inspection and testing.
- 3) Submit the Training Identification Numbers (TINs) or any other information which will be traceable to the certification agency's training location and dates for all technicians performing sampling, testing and inspection for both field and laboratory tests. Provide the names of the Florida Department of Transportation's Construction Training and Qualification Program (CTQP) certifications and other pertinent certifications held and the expiration dates for each certification for each technician. Include employed and subcontracted technicians.

#### f. Subcontractors.

- 1) Include the work of all subcontractors.
- 2) If a subcontractor is to perform work subject to the requirements of this Article, detail how that subcontractor will interface with Contractor's and other subcontractor's organizations.

#### g. Raw Materials:

- 1) Source: Identify the sources of raw materials. Provide locations and plant or mine numbers when applicable. Include the mailing address, physical address including county of the plant, telephone and fax numbers, E-mail address, primary contact at the plant, responsible person in charge, facility number provided by the FDOT, Owner information and Vendor Number and other information as required.
- 2) Certification: Describe methods of verifying compliance of certification with the Specifications.
- 3) Disposition of Failing Materials: Describe the system for controlling non-conforming materials, including procedures for identification, isolation and disposition.
- 4) Storage Facilities for Raw Materials: Describe measures and methods, including bedding details, for preventing segregation, contamination and degradation.
- 5) Describe methods of identifying individual materials. Where applicable, submit a site plan showing the locations of various materials.

#### h. Production Equipment: Describe calibration frequencies, maintenance schedule and procedures for production equipment.

#### i. Other Requirements:

- 1) Copy of Certification: Attach certifications issued by the plant/Contractor for the products approved by the FDOT that will be used in the Project.
  - 2) Statement of Compliance: Include a statement of compliance with all quality requirements set forth by the Department in the Contract Documents.
  - 3) Information on Producers with Accepted FDOT Quality Control Programs: All producers of materials listed herein in Subarticle 105-G.1 must have FDOT accepted QC Programs and be listed on the FDOT's List of Producers with Accepted QC Programs. Identify the Producers of materials for the Project and include the FDOT's Facility Id number as part of the identification.
  - 4) Describing Documentation Procedure: Identify location of document storage to enable Department review. Include QC charts, qualification/accreditation records, inspection reports, and other pertinent/supporting documents for an approved CQCP.
- j. Final Manufactured Product - Plant Operations: Describe inspection schedule and methods for identifying defects and non-compliance with the specifications. Describe corrective actions and methods to resolve them.
- 1) Storage: When storage of the produced materials is required and it is not defined in the Contract Documents, describe the methods and duration for storage. Include measures and methods for preventing segregation, contamination and degradation during storage.
  - 2) Disposition of Failing Materials: When not described in the specifications, describe the methods and measures for identifying and controlling the failing materials. Include preventive and corrective measures. Describe disposition of failing materials.
- k. Final Manufactured Product - Field Operations:
- 1) Transportation: Describe the method of delivery from the point of production/storage to the point of placement.
  - 2) Storage: When storage of the produced materials is required and it is not defined in the Contract Documents, describe the methods and duration for storage. Include measures and methods for preventing segregation, contamination and degradation during storage.
  - 3) Placement: Describe the methods and identify the type of equipment used in incorporation of the materials into the project.
  - 4) Disposition of Failing Materials: When not described in the specifications, describe the methods and measures for identifying and controlling the failing materials. Include preventive and corrective measures. Describe disposition of failing materials.
- C. Quality Control Plan Submittal.
1. Submit the CQCP to Engineer for approval within 21 days after the Contract Award or at the Preconstruction Conference, whichever is sooner. Do not incorporate materials into the Project or begin any work subject to the CQCP prior to Engineer's acceptance of the CQCP.
  2. Modifications or additions may be required to any part of the CQCP that is not adequately covered. Acceptance of the CQCP will be based on the inclusion of the required information. Acceptance does not imply any warranty by the County that the CQCP will result in consistent contract compliance. It remains the responsibility of Contractor to demonstrate such compliance.
  3. If at any time Contractor is not in compliance with the approved CQCP, or a part thereof, affected portions of the CQCP will be disapproved. Cease work in the affected operation(s) and submit a revision to Engineer. If the CQCP, or a part thereof, must be revised, submit the revision to Engineer. Engineer will review the revision and respond within seven calendar days of receipt.
  4. Continue to work on operations that are still in compliance with the approved sections of the CQCP.
  5. As work progresses, submit to Engineer for acceptance supplementary documentation to the CQCP whenever quality control or quality control personnel changes are necessary.
- D. Quality Control Documentation.
1. Maintain complete testing and inspection records by pay item number and make them accessible to Engineer. When or where required, submit the record and certification within one working day of the work being performed. If the record is incomplete, in error, or otherwise misleading, a copy of the record will be returned with corrections noted. When chronic errors or omissions occur, correct the procedures by which the records are produced.
  2. Submission of Materials Certification and Reporting Test Results: Provide certifications prior to placement of materials. Report test results at completion of the test and meet the requirements of the applicable Specifications.
  3. Worksheets: Make available to the Department, when requested, worksheets used for collecting test information. Ensure the worksheets at a minimum contain the following:
    - a. Project Identification Number,
    - b. Time and Date,
    - c. Laboratory Identification and Name,
    - d. Training Identification Numbers (TIN) and initials,
    - e. Record details as specified within the test method.
  4. Inspections to Assure Compliance with Acceptance Criteria.
    - a. General: The Department is not obligated to make an inspection of materials at the source of supply, manufacture, or fabrication.
    - b. Quality Control Inspection: Provide all necessary inspection to assure effective Quality Control of the operations related to materials acceptance. This includes but is not limited to sampling and testing, production, storage, delivery, construction and placement. Ensure that the equipment used in the

production and testing of the materials provides accurate and precise measurements in accordance with the applicable Specifications. Maintain a record of all inspections, including but not limited to, date of inspection, results of inspection, and any subsequent corrective actions taken. Make available to the Department the inspection records, when requested.

c. Notification of Placing Order:

- 1) Order materials sufficiently in advance of their incorporation in the work to allow time for sampling, testing and inspection. Notify Engineer, prior to placing orders for materials.
- 2) Submit to Engineer a fabrication schedule for all items requiring commercial inspection, before or at the preconstruction meeting. These items include, but are not limited to steel bridge components, overhead cantilevered sign supports with cantilevered arms exceeding 41 feet, moveable bridge components or any other item identified as an item requiring commercial inspection in the Contract Documents.
- 3) Notify Engineer at least 30 days before beginning any production and include a production schedule.

E. Contractor Certification of Compliance.

1. Provide Engineer with a notarized monthly certification of compliance with the requirements of this Article, to accompany each progress estimate, on a form acceptable by Engineer. The Department may not authorize payment of any progress estimate not accompanied by an executed certification document.
2. Final payment will not be made until a final notarized certification summarizing all QC exceptions has been submitted.

F. Personnel Qualifications.

1. General:

- a. Provide qualified personnel for sampling, testing and inspection of materials and construction activities. Ensure that qualifications are maintained during the course of sampling, testing and inspection.
- b. Construction operations that require a qualified technician must not begin until Engineer verifies that the technician is on the FDOT CTQP list of qualified technicians.

2. QC Manager:

- a. Designate a QC Manager who has full authority to act as Contractor's agent to institute any and all actions necessary for the successful implementation of the CQCP. The QC Manager must speak and understand English. The QC Manager must be on-site at the Project on a daily basis or always available upon four hours notice to administer the CQCP. This includes administering, implementing, monitoring, and as necessary, adjusting the processes to ensure compliance with the Contract Documents. Ensure that the QC Manager is qualified as such through the FDOT CTQP.

- b. Under the direction of the QC Manager, and using standard forms approved by Engineer, summarize the daily QC activities including testing and material sampling. Since erasures are strictly prohibited on all reports and forms, use blue or colored ink. Do not use black ink. If manual corrections to original data are necessary, strike through, correct, and date the entry, including the initials of the person making the correction. Make copies of the completed forms available for the Department to review daily unless otherwise required in the specifications. Maintain all QC related reports and documentation for a period of three years from final acceptance of the Project. Make copies available for review by the Department upon request.

3. Worksite Traffic Supervisor:

- a. Provide a Worksite Traffic Supervisor who is responsible for initiating, installing, and maintaining all traffic control devices as described in Article 102 (Maintenance of Traffic) and in the Contract Documents. Ensure that the Worksite Traffic Supervisor is certified in the advanced training category by a FDOT approved training Provider. Approved Providers will be posted on the FDOT's website at the following URL address:

1) <http://www.dot.state.fl.us/rddesign/MOT/MOT.shtm>

- b. Use approved alternate Worksite Traffic Supervisors when necessary.

4. Flagger: Provide trained flaggers to direct traffic where one-way operation in a single lane is in effect and in other situations as required. The Worksite Traffic Supervisor or others as approved by the Department will provide training for flaggers.

5. Earthwork Quality Control Personnel:

- a. Earthwork Level I: Ensure the technician who samples soil and earthwork materials from the roadway project, takes earthwork moisture and density readings, and records those data in the Density Log Book holds a CTQP Earthwork Construction Inspection Level I qualification.
- b. Earthwork Level II: Ensure the technician responsible for determining the disposition of soil and earthwork materials on the roadway, and for interpreting and meeting Contract Document requirements holds a CTQP Earthwork Construction Inspection Level II qualification.

6. Asphalt Quality Control Personnel:

- a. Plant Technicians: For asphalt plant operations, provide a QC technician, qualified as a CTQP Asphalt Plant Level II technician, available at the asphalt plant at all times when producing mix for the Department. Perform all asphalt plant related testing with a CTQP Asphalt Plant Level I technician. As an exception, measurements of temperature may be performed by someone under the supervision of a CTQP Plant Level II technician.
- b. Paving Technicians: For paving operations (with the exception of miscellaneous or temporary asphalt), keep a qualified CTQP Asphalt Paving Level II technician on the roadway at all times when placing asphalt mix for the Department, and perform all testing with a CTQP



Asphalt Paving Level I technician. As an exception, measurements of cross-slope, temperature, and yield (spread rate) can be performed by someone under the supervision of a CTQP Paving Level II technician at the roadway.

- c. Mix Designer: Ensure all mix designs are developed by individuals who are CTQP qualified as an Asphalt Hot Mix Designer.
- d. Documentation: Document all QC procedures, inspection, and all test results and make them available for review by Engineer throughout the life of the Contract. Identify in the asphalt producer's Quality Control Plan the Quality Control Manager(s) and/or Asphalt Plant Level II technician(s) responsible for the decision to resume production after a quality control failure.

7. Concrete QC Personnel:

- a. Concrete Field Technician - Level I: Ensure technicians performing plastic property testing on concrete for materials acceptance are qualified CTQP Concrete Field Technicians Level I. Plastic property testing will include but not be limited to slump, temperature, air content, water-to-cementitious materials ratio calculation, and making and curing concrete cylinders. Duties will include initial sampling and testing to confirm specification compliance prior to beginning concrete placements, ensuring timely placement of initial cure and providing for the transport of compressive strength samples to the designated laboratories.
- b. Concrete Field Inspector - Level II: Ensure field inspectors responsible for the quality of concrete being placed on major bridge projects are qualified CTQP Concrete Field Inspectors Level II. A Level II Inspector must be present on the jobsite during all concrete placements. Prior to the placement of concrete, the inspector will inspect the element to be cast to ensure compliance with Contract Documents. A Level II Inspector's duties may include ensuring that concrete testing, inspection, and curing in the field are performed in accordance with the Contract Documents. The QC Inspector will inform the Verification Inspector of anticipated concrete placements and LOT sizes.
- c. Concrete Laboratory Technician:
  - 1) Concrete Laboratory Technician - Level I: Ensure technicians testing cylinders and recording concrete strength for material acceptance are qualified CTQP Concrete Laboratory Technicians Level I. Duties include final curing, compressive strength testing, and the recording/reporting of all test data.
  - 2) Concrete Laboratory Technician – Level II: Ensure that laboratories providing hardened property test results to the Department are under the supervision of a CTQP Concrete Laboratory Technician - Level II. This person is responsible to ensure that the tests are performed in accordance with Standard Test Methods, project specifications and other contract documents.

8. Supervisory Personnel – Post-Tensioned and Movable Bridge Structures:

- a. General: Provide supervisory personnel meeting the qualification requirements only for the post-tensioned and movable bridge types detailed in this Article. Submit qualifications to Engineer at the pre-construction conference. Do not begin construction until the qualifications of supervisory personnel have been approved by Engineer.
- b. Proof of License or Certification:
  - 1) Submit a copy of the Professional Engineer license current and in force issued by the state in which registration is held. The license must be for the field of engineering that the construction work involves such as Civil, Electrical or Mechanical. Under certain circumstances Florida registration may be required.
  - 2) Submit a copy of the license issued by the State of Florida for tradesmen that require a license indicating that the license is in force and is current. Submit a copy of the certification issued by the Instrumentation, Systems and Automation Society of America for each Certified Control Systems Technician.
- c. Experience Record: Submit the following information for supervisory personnel to substantiate their experience record. The supervisor (project engineer, superintendent/manager or foreman) seeking approval must provide a notarized certification statement attesting to the completeness and accuracy of the information submitted. Provide the following experience information for each individual seeking approval as a supervisor:
  - 1) Project owner's name and telephone number of an owner's representative, project identification number, state, city, county, highway number and feature intersected.
  - 2) Provide a detailed description of each bridge construction experience, and the level of supervisory authority during that experience. Report the duration in weeks, as well as begin and end dates, for each experience period.
  - 3) Provide the name, address and telephone number of an individual that can verify that the experience being reported is accurate. This individual should have been an immediate supervisor unless the supervisor cannot be contacted in which case another individual with direct knowledge of the experience is acceptable.
- d. Concrete Post-Tensioned Segmental Box Girder Construction: Ensure the individuals filling the following positions meet the minimum requirements as follows:
  - 1) Project Engineer-New Construction: Ensure the Project Engineer is a registered Professional Engineer with five years of bridge construction experience. Ensure a minimum of three years of experience is in Segmental Box Girder Construction Engineering and includes a minimum of one year in segmental casting yard operations and related surveying, one year in segment erection and related surveying, including post-tensioning and grouting of longitudinal tendons and a minimum of one year as the Project Engineer in responsible charge of

Segmental Box Girder Construction Engineering. Ensure this individual is present at the site of construction, at all times while segmental box girder construction or segment erection is in progress.

- 2) Project Engineer-Repair and Rehabilitation: Ensure the Project Engineer is a registered Professional Engineer with five years of bridge construction experience. Ensure a minimum of three years of experience is in Segmental Box Girder Construction Engineering and includes one year of post-tensioning and grouting of longitudinal tendons and a minimum of one year as the Project Engineer in responsible charge of Segmental Box Girder rehabilitation engineering or Segmental Box Girder new construction engineering.
- 3) Project Superintendent/Manager - New Construction:
  - a) Ensure the Project Superintendent/Manager has a minimum of ten years of bridge construction experience or is a registered Professional Engineer with five years of bridge construction experience. Ensure that a minimum of three years of experience is in Segmental Box Girder construction operations and includes a minimum of one year in the casting yard operations and related surveying, one year in segment erection and related surveying including post-tensioning and grouting of longitudinal tendons and a minimum of one year as the Project
  - b) Superintendent/Manager in responsible charge of Segmental Box Girder construction operations. Ensure this individual is present at the site of construction, at all times while segmental box girder construction or segment erection is in progress.
- 4) Project Superintendent/Manager-Repair and Rehabilitation: Ensure the Project Superintendent/Manager has a minimum of five years of bridge construction experience or is a registered Professional Engineer with three years of bridge construction experience. Ensure that a minimum of two years of experience is in Segmental Box Girder construction operations and includes a minimum of one year experience performing post-tensioning and grouting of longitudinal tendons and a minimum of one year as the Project Superintendent/Manager in responsible charge of Segmental Box Girder rehabilitation operations or Segmental Box Girder new construction operations.
- 5) Foreman-New Construction: Ensure that the Foreman has a minimum of five years of bridge construction experience with two years of experience in Segmental Box Girder Operations and a minimum of one year as the foreman in responsible charge of Segmental Box Girder new construction Operations. Ensure this individual is present at the site of construction, at all times while segmental box girder construction or segment erection is in progress.
- 6) Foreman-Repair and Rehabilitation: Ensure the Foremen has a minimum of five years of bridge construction experience with two years of

experience in Segmental Box Girder Operations and a minimum of one year as the foreman in responsible charge of Segmental Box Girder rehabilitation operations or Segmental Box Girder new construction operations.

7) Geometry Control Engineer/Manager:

- a) Ensure that the Geometry Control Engineer/Manager for construction of cast-in-place box segments is a registered Professional Engineer with one year of experience, a non-registered Engineer with three years of experience or a Registered Professional Land Surveyor with three years of experience in geometry control for casting and erection of cast-in-place box segments. Credit for experience in cast-in-place box girder geometry control will be given for experience in precast box girder geometry control but not vice versa.
  - b) Ensure that the Geometry Control Engineer/Manager for precast box segments is a registered Professional Engineer with one year of experience or non-registered with three years of experience in casting yard geometry control of concrete box segments.
  - c) The Geometry Control Engineer/Manager must be responsible for and experienced at implementing the method for establishing and maintaining geometry control for segment casting yard operations and segment erection operations and must be experienced with the use of computer programs for monitoring and adjusting theoretical segment casting curves and geometry. This individual must be experienced at establishing procedures for assuring accurate segment form setup, post-tensioning duct and rebar alignment and effective concrete placement and curing operations as well as for verifying that casting and erection field survey data has been properly gathered and recorded. Ensure this individual is present at the site of construction, at all times while cast-in-place segmental box girder construction is in progress or until casting yard operations and segment erection is complete.
- 8) Surveyor: Ensure that the Surveyor in charge of geometry control surveying for box segment casting and/or box segment erection has a minimum of one year of bridge construction surveying experience. Ensure this individual is present at the site of construction, at all times while segmental box girder construction or segment erection is in progress.
- e. Movable Bridge Construction: Ensure the individual filling the following positions meet the minimum requirements as follows:
- 1) Electrical Journeyman: Ensure the Electrical Journeyman holds, an active journeyman electrician's license and has at least five years experience in industrial electrical work, or is a Certified Control Systems Technician. A Certified Control Systems Technician will not be permitted to perform electrical power work including, but not limited to, conduit and wire-way installation or

power conductor connection. Ensure the electrical journeyman has successfully completed the installation of one similar movable bridge electrical system during the last three years.

- 2) Control Systems Engineer and Mechanical Systems Engineer: Ensure the Control Systems Engineer and Mechanical Systems Engineer are both registered Professional Engineers with a minimum of 10 years supervisory experience each in movable bridge construction. Ensure the engineers have working knowledge of the movable bridge leaf motion control techniques, mechanical equipment and arrangements specified for this project. Ensure that each Engineer has been in responsible control of the design and implementation of at least three movable bridge electrical control and machinery systems within the past 10 years of which, at least one of the three bridges was within the last three years. Ensure that a minimum of one of the three bridge designs incorporated the same type of leaf motion control and machinery systems specified for this project.
- f. Concrete Post-Tensioned Other Than Segmental Box Girder Construction: Ensure the individual filling the following positions meet the minimum requirements as follows:
- 1) Project Engineer: Ensure the Project Engineer is a registered Professional Engineer with five years of bridge construction experience. Ensure that a minimum of three years of experience is in concrete post-tensioned construction. Ensure that the three years of experience includes experience in girder erection, safe use of cranes, stabilization of girders; design of false work for temporary girder support, post-tensioning and grouting operations, and a minimum of one year as the Project Engineer in responsible charge of post-tensioning related engineering responsibilities.
  - 2) Project Superintendent/Manager: Ensure the Project Superintendent/Manager has a minimum of ten years of bridge construction experience or is a registered Professional Engineer with five years of bridge construction experience and has a minimum of three years of supervisory experience in girder erection, safe use of cranes, stabilization of girders; design of falsework for temporary girder support post-tensioning, grouting operations and a minimum of one year as the Project Superintendent/Manager in responsible charge of post-tensioning related operations.
  - 3) Foreman: Ensure the Foremen has a minimum of five years of bridge construction experience with two years of experience in post-tensioning related operations and a minimum of one year as the foreman in responsible charge of post-tensioning related operations.
- g. Post-Tensioning (PT) and Grouting Personnel Qualifications: Perform all stressing and grouting operations in the presence of Engineer and with personnel meeting the qualifications of this article. Coordinate and schedule all PT and grouting activities to facilitate inspection by Engineer.

- 1) Post-Tensioning: Perform all PT field operations under the direct supervision of a Level II CTQP Qualified PT Technician who must be present at the site of the post-tensioning work during the entire duration of the operation. For the superstructures of bridges having concrete post-tensioned box or I girder construction, provide at least two CTQP qualified PT technicians, Level I or II, on the work crew. The supervisor of the work crew, who must be a Level II CTQP Qualified PT Technician, may also be a work crew member, in which case, the supervisor shall count as one of the two CTQP qualified work crew members. For PT operations other than the superstructures of post-tensioned box or I girder construction, perform all PT operations under the direct supervision of a Level II CTQP Qualified PT Technician who must be present at the site of the PT work during the entire duration of the operation. Work crew members are not required to be CTQP qualified.

2) Grouting:

- a) Perform all grouting field operations under the direct supervision of a Level II CTQP Qualified Grouting Technician who must be present at the site of the grouting work during the entire duration of the operation. For the superstructures of bridges having concrete post-tensioned box or I girder construction, provide at least two CTQP qualified grouting technicians, Level I or II, on the work crew. The supervisor of the work crew, who must be a Level II CTQP Qualified Grouting Technician, may also be a work crew member, in which case, the supervisor shall count as one of two CTQP qualified work crew members.
- b) For grouting operations other than the superstructures of post-tensioned box or I girder construction, perform all grouting operations under the direct supervision of a Level II CTQP Qualified Grouting Technician who must be present at the site of the grouting work during the entire duration of the operation. Work crew members are not required to be CTQP qualified.
- c) Perform all vacuum grouting operations under the direct supervision of a crew foreman who has been trained and has experience in the use of vacuum grouting equipment and procedures. Submit the crew foreman's training and experience records to Engineer prior to performing any vacuum grouting operation.

h. Failure to Comply with Bridge Qualification Requirements:

- 1) Make an immediate effort to reestablish compliance. If an immediate effort is not put forth as determined by Engineer, payment for the bridge construction operations requiring supervisors to be qualified under this Specification will be withheld up to 60 days. Cease all bridge construction and related activities (casting yard, etc.) if compliance is not met within 60 days, regardless of how much effort is put forth. Resume bridge construction operations only after written approval from Engineer stating that compliance is reestablished.

9. Prestressed Concrete Plant Quality Control Personnel:

- a. Ensure each prestressed concrete plant has an onsite production manager, an onsite Plant Quality Control Manager, a Plant engineer, and adequate onsite QC inspectors/technicians to provide complete QC inspections and testing.
- b. Ensure the Plant Manager for QC has at least five years of related experience and a current PCI QC personnel Level III certification and a certificate of completion of FDOT Section 450 Specification examination. Ensure that the QC inspector/technician has current PCI QC Technician/Inspector Level II certification and a certificate of completion of FDOT Section 450 Specification examination.
- c. Ensure that the batch plant operators of the ready mixed concrete batch plants meet the requirements of Section 9.2 of the FDOT Materials Manual. Ensure that the batch plant operators of the onsite centrally mixed concrete plants meet the training requirements of Subarticle 105-F.11.b.4) b) below.

10. Signal Installation Inspector:

- a. Provide an inspector trained and certified by the International Municipal Signal Association (IMSA) as a Traffic Signal Inspector to perform all signal installation inspections. Use only Department approved signal inspection report forms during the signal inspection activities.
- b. Ensure all equipment, materials, and hardware is in compliance with Department Specifications and verify that all equipment requiring certification is listed on the PWWM Traffic Signals And Signs Qualified Products List (TSSQPL) <http://www.miamidade.gov/qpl/>.
- c. Provide the completed signal inspection report form(s), certified by the IMSA Traffic Signal Inspector to Engineer. Sample forms are available at the FDOT webpage <http://www.dot.state.fl.us/trafficoperations> address:

11. Pipe and Precast Concrete Products Manufacturing Facilities Quality Control Personnel:

- a. General: Obtain personnel certifications from FDOT accredited training providers. The list of FDOT approved courses and their accredited providers is available on the State Materials Office website.
- b. Precast Concrete Drainage Structures, Precast Concrete Box Culvert, Precast Concrete Pipe, Incidental Precast Concrete, and Flexible Pipe Manufacturing Facilities Quality Control Personnel:
  - 1) Level I Quality Control Inspectors: Ensure that the Level I Inspectors have completed a minimum of a 12-hour, Department approved, Level I QC Inspector training course in the respective work area. As an exception to this, ensure Flexible Pipe Level I QC Inspectors have completed a minimum of an 8-hour, Department approved, Level I QC Flexible Pipe Inspector training course. For Incidental Precast Concrete, as an alternative to the completion of the 12-hour training course, the Department will accept QC personnel meeting the requirements of Subarticle 105-F.11.b.4)a) below and CTQP Concrete Field Technician level I certification or Precast/Prestressed Concrete

Institute (PCI) Quality Control Technician/Inspector Level II certification.

- 2) Level II Quality Control Inspectors: Ensure that Level II Inspectors have completed FDOT approved Level I QC Inspector training and a minimum of a 5-hour, FDOT approved, Level II QC Inspector training course in the respective work areas. For Incidental Precast Concrete, as an alternative to the completion of the 5-hour training course, the Department will accept CTQP Concrete Field Technician Level II or PCI Quality Control Level III certifications.

- 3) Plant Quality Control Manager: Ensure that QC Manager has completed FDOT approved Level II QC Inspector training and has a minimum of 2 years construction related experience in the specific work area.

- 4) Additional Requirements for Quality Control Personnel of Precast Concrete Drainage, Precast Concrete Box Culvert, and Incidental Precast Concrete Manufacturing Facilities:

- a) Testing Personnel: Ensure the personnel performing plastic property tests have ACI Concrete Field Testing Technician-Grade I certification. Ensure the personnel performing laboratory compressive strength testing have ACI Concrete Laboratory Testing Technician-Grade 1 certification or ACI Concrete Strength Testing Technician certification.

- b) Batch Plant Operator: Ensure the concrete batch plant operator is qualified as a CTQP Concrete Batch Plant Operator. As an alternative to CTQP qualification, the Department will accept the completion of a minimum of a 6-hour, FDOT approved, Batch Plant Operator training course.

12. Structural Steel and Miscellaneous Metals Fabrication Facility Quality Control Personnel:

- a. Ensure each fabrication facility has an onsite production manager, an onsite facility manager for QC, a plant engineer, and on site QC inspectors/technicians to provide complete QC inspections and testing.
- b. Ensure that the Facility Manager for QC and QC inspectors/technicians meet the certification requirements set forth in the latest version of AASHTO/NSBA Steel Bridge Collaboration S 4.1, Steel Bridge Fabrication QC/QA Guide Specification, including the years of experience required in Table 105-1 below. The Facility Manager for QC must meet the requirements of Table 105-1 for every Structural Steel Member Type produced by a plant with QC being managed by the Facility Manager for QC. The Facility Manager for QC will report directly to the plant manager or plant engineer and must not be the plant production manager nor report to or be the subordinate of the plant production manager. QC inspectors/technicians must be the employees of, and must report directly to the Facility Manager for QC.

TABLE 105-1 Experience Requirements for QC Inspectors/Technicians And Facility Manager for Quality Control		
Structural Steel Member Type	Minimum Years of Experience Required	
	QC Inspector/Technician	Facility Manager for QC
Rolled beam bridges	1 year	3 years
Welded plate girders (I sections, box sections, etc.)	2 years	4 years
Complex structures, such as trusses, arches, cable stayed bridges, and moveable bridges	3 years	5 years
Fracture critical (FC) members	3 years	5 years

G. FDOT Quality Control Program.

1. Producers for the following materials must have an accepted FDOT Quality Control Program during the production of materials to be used on Department projects and be currently listed in the FDOT Materials/Producer Listings and must meet and maintain the approved FDOT Quality Control Program requirements at all times while producing materials that will be incorporated into the Project  
(<http://www.dot.state.fl.us/statematerialsoffice/quality/programs/qualitycontrol/materialslistings/postjuly2002.shtm>)  
:
  - a. Aggregate
  - b. Asphalt Mix
  - c. Cementitious Material
  - d. Drainage Products
  - e. Earthwork
  - f. Galvanize Metal Products
  - g. Portland Cement Concrete (Structural)
  - h. Prestress/Precast Concrete Products
  - i. Steel and Miscellaneous Metal
  - j. Timber
2. When accreditation or certification is required, make supporting documents from the two previous inspections performed by the accrediting or certifying agency available to the Department upon request.
3. Prestressed Concrete Quality Control Program: Ensure that prestressed concrete plants participating in the FDOT's Acceptance Program are qualified. Obtaining qualification requires a current certification from a FDOT approved precast prestressed concrete plant certification agency and a FDOT approved Quality Control Plan. The list of FDOT approved certification agencies is available on the website of the FDOT State Materials Office.

4. Steel and Miscellaneous Metals Quality Control Program:

- a. Ensure that the fabricators of Steel and miscellaneous metal products participating in the FDOT's Quality Control Acceptance Program are qualified. Obtaining qualification requires an accepted FDOT Quality Control Plan. A current American Institute for Steel Construction (AISC) certification is a requirement for the Quality Control Acceptance Program of the steel and miscellaneous metal fabricators, provided that AISC certification program is available for the category of the fabrication products.
- b. Steel and Miscellaneous Metal products, including aluminum, are defined as the metal components of bridges, including pedestrian and moveable bridges, overhead and cantilevered sign supports, ladders and platforms, bearings, end wall grates, roadway gratings, drainage items, expansion joints, roadway decking, shear connectors, handrails, galvanized products, fencing, guardrail, light poles, high mast light poles, standard mast arm assemblies and Monotube assemblies, stay in-place forms, casing pipe, strain poles, fasteners, connectors and other hardware.

**107 LITTER REMOVAL AND MOWING (REV. 11-25-2015)**

H. Description.

1. Contractor to be responsible for the work below in areas where the County or the property owner has restricted or limited access to maintain the property.
  - a. Provide pickup, removal and disposal of litter within the project limits from the outside edge of travel way to the right of way line. Include the median on divided highways, from the inside edge of travel way to the inside edge of travel way. Litter includes; but is not limited to, bottles, cans, paper, tires, tire pieces, lumber, vehicle parts, metal junk, and brush debris. Exclude any inaccessible areas or areas identified in the Plans as new landscaping in accordance with the Contract Documents.
  - b. Mow turf or vegetation within the project limits. Turf consists of grasses planted in accordance with FDOT Section 570. Vegetation consists of planted and natural grasses, weeds, and other natural vegetation that have been previously mowed. Exclude any areas identified in the Plans as new landscaping in accordance with the Contract Documents.

I. Operation.

1. Frequency:
  - a. Remove litter daily from the beginning of the project until final completion, unless otherwise directed by the Engineer. Continue litter removal until final acceptance.
  - b. Begin mowing when directed by the Engineer and continue per the frequency agreed, (every month or less depending of the weather season) unless otherwise directed by the Engineer. Mow all areas to obtain a uniform height of 6 inches. Maintain turf and vegetation height between 6 inches and 12 inches. Do not include seed stalk or wildflowers when measuring

height. Continue mowing until final acceptance. After final acceptance perform litter removal and mowing until new turf is established in accordance with FDOT 570-4 at no cost to the County.

- c. Perform litter removal prior to and in conjunction with mowing; however, the Engineer may direct litter pickups in addition to those performed in conjunction with mowing. Do not mow new turf until a healthy root system is established. In designated wildflower areas, avoid cutting wildflowers when in bloom and when re-seeding.

2. General:

- a. Mow shoulders and medians concurrently so that not more than one mile will be left partially mowed at the conclusion of the working day. Mow turf and vegetation on slopes or around appurtenances concurrent with the mowing operation. In areas saturated with standing water, mow or cut to the surface of the water using hand labor or other specialized equipment when standard equipment will cause damage. Do not remove turf or other vegetation cuttings from the right-of-way, or rake or pick up the cuttings unless the cuttings are in the traveled ways, bike lanes, or sidewalk; are obstructing drainage structures; or are the result of cleaning the equipment.

3. Limitations:

- a. Maintain traffic in accordance with Article 102-Maintenance of Traffic. When mowing within four feet of a travel lane, operate the equipment in the same direction of traffic, unless the adjacent lane is closed to traffic due to construction operations. Perform all work during daylight hours.

4. Disposal of Litter and Debris:

- a. During each litter removal cycle, bag and remove all litter or piles at the end of each working day. Dispose of litter in accordance with applicable local and state laws. Do not store or stockpile litter within the project limits.

J. Method of Measurement.

- 1. No measure is included for litter removal or mowing.

K. Basis of Payment.

- 1. All work and incidental costs specified as being covered under this Article will be included for payment under the several scheduled items of the overall Contract.
- 2. No separate payment will be made for Litter Removal and Mowing.

**110 CLEARING AND GRUBBING (REV. 05-16-11)**

A. General.

- 1. Perform all Clearing and Grubbing required by the Contract Documents or necessary to prepare the Project site for the proposed construction.

- 2. Remove and dispose of all structures, material, product and debris not required to be salvaged or not required to complete the construction.
- 3. Trim trees and shrubs within the Project right-of-way that are required by the Contract Documents or necessary for the construction of the Project.
- 4. Perform the work and meet all the requirements for the miscellaneous operations described in Subarticle B.6 herein.
- 5. Protect and do not displace structures which are to remain in place.

B. Clearing and Grubbing:

1. Standard Clearing and Grubbing.

- a. Perform Standard Clearing and Grubbing within:
  - 1) Right-of-way of the roadway to be constructed.
  - 2) All Project areas, whether or not shown in the Plans, that require Clearing and Grubbing including:
    - a) Areas where excavation is to be done.
    - b) Areas where roadway embankments will be constructed.
    - c) Areas where structures will be constructed or installed.

b. Work includes complete removal and disposal of:

- 1) All buildings, structures, appurtenances, existing pavement, trees, plants, vegetation, timber, brush, stumps, roots, rubbish, debris, and all other obstructions resting on or protruding through the surface of the existing ground and the surface of excavated areas.
- 2) All other structures and obstructions necessary to be removed and for which other items of the Contract do not specify the removal thereof.
- 3) Any boulders encountered in the roadway excavation or found on the surface of the ground unless otherwise permitted by the Contract Documents

c. Depths of Removal of Roots, Stumps, and Other Debris:

- 1) Completely remove and dispose of all stumps found within the roadway right-of-way.
- 2) Remove roots and other debris from all excavated material to be used in the construction of roadway embankment.
- 3) In all areas where excavation is to be performed or roadway embankments are to be constructed, plow the surface to a depth of at least 6 inches, and remove roots and other debris to a depth of 12 inches below the ground surface.
- 4) Remove all roots and other debris protruding through or appearing on the surface of the completed excavation within the roadway area and for structures, to a depth of at least 12 inches below the finished excavation surface.

- 5) In borrow pits, material pits, and lateral ditches, remove or cut off all stumps, roots, etc. below the surface of the completed excavation. Do not perform any clearing or grubbing within 3 feet inside the right-of-way line in borrow and material pits.
  - 6) Within all other areas where Standard Clearing and Grubbing is to be performed, remove roots and other debris projecting through or appearing on the surface of the original ground to a depth of 12 inches below the surface, but do not plow or harrow these areas.
- d. Trees to Remain:
- 1) As an exception to the above provisions, where so directed by the Engineer, trim, protect, and leave standing desirable trees within the Project area.
  - 2) Trim branches of trees extending over the area occupied by the roadway as directed, to give a clear height of 16 feet above the roadway.
2. Selective Clearing and Grubbing.
- a. Perform Selective Clearing and Grubbing only in areas so designated in the Plans or where directed by the Engineer.
  - b. Completely remove and dispose of stumps and remove and dispose of all vegetation, obstructions, etc., as required for Standard Clearing and Grubbing except that, where so elected, the Contractor may cut roots flush with the ground surface.
  - c. Entirely remove undergrowth except in specific areas designated by the Engineer to remain for aesthetic purposes.
  - d. Trim, protect, and leave standing desirable trees, with the exception of such trees as the Engineer may designate to be removed in order to facilitate right-of-way maintenance. Remove undesirable or damaged trees as so designated by the Engineer.
3. Removal of Buildings.
- a. Completely remove all parts of the buildings, including utilities, plumbing, foundations, floors, basements, steps, connecting concrete sidewalks or other pavement, septic tanks, and any other appurtenances, by any practical manner which is not detrimental to other property and improvements. Remove utilities to the point of connection to the utility authority's cut-in.
  - b. After removing the sewer connections to the point of cut-in, construct a concrete plug at the cut-in point, as directed by the Engineer, except where the utility owners may elect to perform their own plugging. Contact the appropriate utility companies prior to removal of any part of the building to ensure disconnection of services.
  - c. Removal by Others: Where buildings within the area to be cleared and grubbed are so specified to be removed by others, remove and dispose of any foundations, curtain walls, concrete floors, basements or other foundation parts which might be left in place after such removal of buildings by others.
4. Removal of Existing Structures.
- a. Structures to be removed include:
    - 1) Structures, or portions of structures, shown in the Plans to be removed;
    - 2) Structures, or portions of structures, found within the areas requiring Clearing and Grubbing, and directed by the Engineer to be removed;
    - 3) Structures, or portion of structures, which are necessary to be removed in order to construct new structures; and
    - 4) All other appurtenances or obstructions which may be designated in the Contract Documents as to be included for removal under this Article.
  - b. Removal Requirements:
    - 1) General:
      - a) Remove and dispose of all materials from existing structures required to be removed.
      - b) Remove the structures in a neat manner so as to leave no obstructions to any proposed new structures, construction, or to any waterways.
      - c) Pull, cut off, or break off pilings to the requirements of the permit or other Contract Documents, whichever requires the deepest removal, but not less than 2 feet below the finish ground line.
      - d) If Plans indicate channel excavation to be done by others, consider the finish ground line as the limits of such excavation.
      - e) For materials which are to remain the property of the Department or are to be salvaged for use in temporary structures, avoid damage to such materials, and entirely remove all bolts, nails, etc. from timbers to be so salvaged.
      - f) Mark structural steel members for identification as directed.
    - 2) Removal of Steel Members With Hazardous Coatings:
      - a) Provide to the Engineer for approval, a copy of the "Contractor's Lead in Construction Compliance Program" from the firm actually removing and disposing of these steel members before any members are disturbed.
      - b) Vacuum power tool clean any coated steel member to bare metal as defined by SSPC-SP11 a minimum of 4 inches either side of any area to be heated (torch cutting, sawing, grinding, etc.) in accordance with 29 CFR 1926.354. Abrasive blasting is prohibited.
      - c) Provide air supplied respirators in accordance with 29 CFR 1926.62 and 29 CFR 1910.134.
  - c. Partial Removal of Bridges:
    - 1) For all demolition methods, submit for review and approval of the Engineer, a demolition plan that describes the method of removal, equipment to be used, types of rebar splices or couplers, and method of straightening or cutting rebars. In addition, for hydro-demolition, describe the method for control of water or slurry runoff and measures for safe containment of concrete fragments that are thrown out by the hydro-demolition machine.

- 2) Where concrete is to be removed to neat lines, use concrete saws or hydro-demolition methods capable of providing a reasonably uniform cleavage face. If the equipment used will not provide a uniform cut without surface spalling, first score the outlines of the work with small trenches or grooves.
  - 3) On concrete bridges to be partially removed and widened, remove concrete by manually or mechanically operated pavement breakers, by concrete saws, by chipping hammers, or by hydro-demolition methods. Do not use explosives.
- d. Authority of U.S. Coast Guard: For structures in navigable waters, when constructing the project under authority of a U.S. Coast Guard permit, the U.S. Coast Guard may inspect and approve the work to remove any existing structures involved therein, prior to acceptance by the Department.
  - e. Asbestos Containing Materials (ACM) Not Identified Prior to the Work:
    - 1) When encountering or exposing any condition indicating the presence of asbestos, cease operations immediately in the vicinity and notify the Engineer.
    - 2) Make every effort to minimize the disturbance of the ACM. Immediately provide for the health and safety of all workers at the job site and make provisions necessary for the health and safety of the public that may be exposed to any potentially hazardous conditions. Provisions shall meet all applicable laws, rules or regulations covering hazardous conditions and will be in a manner commensurate with the gravity of the conditions.
    - 3) The Engineer will direct the Prime Contractor when operations may resume in the affected area.
5. Removal of Existing Concrete Pavement.
    - a. Remove and dispose of existing rigid portland cement concrete pavement, sidewalk, slope pavement, ditch pavement, curb, and curb and gutter etc., where shown in the plans or ordered by the Engineer to be removed or where required because of the construction operations.
    - b. The work under Removal of Existing Concrete Pavement does not include the removal of retaining walls, drainage structures and flexible asphalt pavement.
  6. Miscellaneous Operations.
    - a. Water Wells Required to be Plugged:
      - 1) Fill or plug all water wells within the right-of-way, including areas of borrow pits and lateral ditches that are not to remain in service, in accordance with applicable Water Management District rules or the Department of Environmental Protection regulations.
      - 2) Cut off the casing of cased wells at least 12 inches below the ground line or 12 inches below the elevation of the finished excavation surface, whichever is lower. Water wells, as referred to herein, are defined either as artesian or non-artesian, as follows:
        - a) An artesian well is an artificial hole in the ground from which water supplies may be obtained and which penetrates any water-bearing rock, the water in which is raised to the surface by natural flow or which rises to an elevation above the top of the water-bearing bed. Artesian wells are further defined to include all holes drilled as a source of water that penetrate any water-bearing beds that are a part of the artesian water system of Florida, as determined by representatives of the applicable Water Management District.
        - b) A non-artesian (water-table) well is a well in which the source of water is an unconfined aquifer. The water in a non-artesian well does not rise above the source bed.
    - b. Landscape Areas: When certain areas of the right-of-way, outside of the limits of construction, are shown in the plans or designated by the Engineer to be landscaped, either under the construction Contract or at a later time, remove undesirable trees, stumps, undergrowth, and vegetation, as directed, and preserve and trim natural growth and trees as directed by the Engineer.
    - c. Leveling Terrain: Within the areas between the limits of construction and the outer limits of clearing and grubbing, fill all holes and other depressions, and cut down all mounds and ridges. Make the area of a sufficient uniform contour so that the Department's subsequent mowing and cutting operations are not hindered by irregularity of terrain. Perform this work regardless of whether the irregularities were the result of construction operations or existed originally.
    - d. Mailboxes: When the Contract Documents require furnishing and installing mailboxes, permit each owner to remove the existing mailbox. Work with the Local Postmaster to develop a method of temporary mail service for the period between removal and installation of the new mailboxes. Install the mailboxes in accordance with the Design Standards.
- C. Ownership of Materials.
    1. Except as may be otherwise specified in the Contract Documents, the Contractor shall take ownership of all buildings, structures, appurtenances, and other materials removed by him and shall dispose of them in accordance with subarticle D below.
  - D. Disposal of Materials.
    1. General:
      - a. Dispose of all debris, timber, stumps, brush, roots, rubbish, and other waste material resulting from clearing and grubbing in areas and by methods meeting the applicable requirements of all Local, State and Federal regulations.
    2. Disposal of Treated Wood:
      - a. Treated wood, including that which comes from bridge channel fender systems, must be handled and disposed of properly during removal.
      - b. Treated wood should not be cut or otherwise mechanically altered in a manner that would generate



dust or particles without proper respiratory and dermal protection.

- c. Treated wood must be disposed of in at least a lined solid waste facility or through recycling/reuse.
- d. Treated wood shall not be disposed by burning or placement in a construction and demolition (C&D) debris landfill.
- e. All compensation for the cost of removal and disposal of treated wood will be included in the Cost of Removal of Existing Structures when an item for direct payment is provided in the Contract. If an item of direct payment is not provided in the Contract, the aforementioned cost is included in the cost for Clearing and Grubbing or among the other items of work in the Contract.

### 3. Hazardous Materials/Waste:

#### a. General:

- 1) Handle, transport and dispose of hazardous materials in accordance with all Local, State and Federal requirements including the following:
  - a) SSPC Guide 7
  - b) Federal Water Pollution Control Act, and
  - c) Resource Conservation and Recovery Act (RCRA).
- 2) Accept responsibility for the collection, sampling, classification, packaging, labeling, accumulation time, storage, manifesting, transportation, treatment and disposal of hazardous waste, both solid and liquid. Separate all solid and liquid waste and collect all liquids used at hygiene stations and handle as hazardous materials/waste. Obtain written approval from the Engineer and required agencies for all hazardous materials/waste stabilization methods before implementation.
- 3) Obtain an EPA/FDEP Hazardous Waste Identification Number (EPA/FDEP ID Number) before transporting and/or disposal of any hazardous materials/waste.
- 4) List the Department as the generator of all hazardous materials/waste.
- 5) Submit the following for the Engineers' approval before transporting, treatment or disposal of any hazardous materials/waste:
  - a) Name, address and qualifications of the transporter,
  - b) Name, address and qualifications of the treatment facility,
  - c) Proposed treatment and/or disposal of all Hazardous Materials/Waste.
- 6) Transport all hazardous materials/waste in accordance with applicable 40 CFR 263 Standards. Provide a copy of all completed Hazardous Materials/Waste manifest/bills of lading to the Engineer within 21 days of each shipment.

#### b. Steel Members With Hazardous Coating:

- 1) Unless otherwise required by the Contract Documents, dispose of steel members with hazardous coating in one of the following manners:

- a) Deliver the steel members and other hazardous waste to a licensed recycling or treatment facility capable of processing steel members with hazardous coating.
- b) Deliver any other hazardous materials/waste to a licensed hazardous materials/waste recycling treatment facility.

2) Dismantle and/or cut steel members to meet the required dimensions of the recycling facility, treatment facility or other regulatory agency.

3) All compensation for the cost of removal and disposal of hazardous materials/waste will be included in the Cost of Removal of Existing Structures when an item for direct payment is provided in the Contract. If an item of direct payment is not provided in the Contract, the aforementioned cost is included in the cost for Clearing and Grubbing or among the other items of work in the Contract.

#### c. Certification of Compliance:

1) Furnish two copies of Certification of Compliance from the firm actually removing and disposing of the hazardous materials/waste stipulating, the hazardous materials/waste has been handled, transported and disposed of in accordance with this Specification.

2) The Certification of Compliance shall be attested to by a person having legal authority to bind the company.

d. Maintain all records required by this Specification and ensure they are available to the Department upon request.

#### E. Method of Measurement.

##### 1. Clearing and Grubbing:

a. No Direct Payment Provided: When no item for direct payment of Clearing and Grubbing is provided by the Contract, the costs for performing all work and meeting the requirements of this Article will be included among the various scheduled items of the Contract.

b. Direct Payment Provided: When direct payment for Clearing and Grubbing is provided in the Contract, the quantity to be paid for will be the lump sum quantity.

2. One or more of the following items may appear in a contract where no direct payment item for Clearing and Grubbing is provided. Only those items with an Awarded Unit Price will be considered for direct payment. All other work of Clearing and Grubbing is included among the various scheduled items of the Contract.

a. Removal of Existing Structures: When a separate item for the Removal of Existing Structures is provided for direct payment in the Contract, the quantity to be paid for will be the lump sum quantity or actual quantities for the specific structures removed, as stipulated in the Contract Documents.

b. Removal of Existing Concrete Pavement: When a separate item for Removal of Existing Concrete Pavement is provided for direct payment in the

Contract, the quantity to be paid for will be the number of square yards of existing pavement of the types listed in subarticle B.5 herein, acceptably removed and disposed of, as specified. The quantity will be determined by actual measurement along the surface of the pavement before its removal. Measurements for appurtenances which have irregular surface configurations, such as curb and gutter, steps, and ditch pavement, will be the area as projected to an approximate horizontal plane. Where the removal of pavement areas is necessary only for the construction of box culverts, pipe culverts, storm sewers, french drains, inlets, manholes, etc., these areas will not be included in the measurements.

- c. Removal of Trees: When separate items for the Removal of Trees are provided for direct payment in the Contract, trees that are greater than 6 inches in diameter, will be paid on a per each basis by actual count by the Engineer of such trees under the appropriate item provided in the Contract. The diameter of a tree shall be obtained by measuring its circumference at 4.5 feet above the ground using a flexible tape measure and dividing the circumference by 3.14. If the tree is growing on a slope, the circumference is measured at 4.5 feet from the center of the slope. If the tree begins to branch below 4.5 feet, measure at the smallest circumference below the first branch.
- d. Plugging Water Wells: When a separate item for Plugging of Water Wells is provided for direct payment in the Contract, the quantity to be paid for will be the number of water wells plugged, for each type of well (artesian or non-artesian).
- e. Mailboxes: When a separate item is provided in the Contract for furnishing and installing mailboxes, the quantity to be paid for will be the number of mailboxes acceptably furnished and installed.
- f. Delivery of Salvageable Material to the Department: When a separate item is provided in the Contract for the delivery of salvageable material to the Department, the quantity to be paid for will be the Lump Sum quantity for delivery of salvageable materials to the Department as indicated in the Plans or as directed by the Engineer.

#### F. Basis of Payment.

##### 1. Clearing and Grubbing:

- a. No Direct Payment Provided: When direct payment for Clearing and Grubbing is not provided in the Contract, the cost of any work of clearing and grubbing necessary for the proper construction of the Project and meeting all requirements of this Article, is included in the Contract price for the structure or other item of work for which such clearing and grubbing is required.
- b. Direct Payment Provided:
  - 1) Price and payment will be full compensation for all clearing and grubbing indicated or required for the construction of the entire Project, including all necessary hauling, furnishing equipment, equipment operation, furnishing any areas required for disposal of debris, leveling of terrain and the landscaping work of trimming, etc., as specified herein, except for any areas designated to be paid

for separately or to be specifically included in the costs of other work under the Contract.

2) Unless otherwise provided by the Contract, price and payment will be full compensation for all work required by this Article including Removal of Existing Structures, Removal of Existing Concrete Pavement, Removal of Trees, Plugging of Water Wells, Mailboxes, and Delivery of Salvageable Material to the Department.

3) Where construction easements are specified in the Plans and the limits of clearing and grubbing for such easements are dependent upon the final construction requirements, no adjustment will be made in the lump sum price and payment, either over or under, for variations from the limits of the easement defined on the Plans.

- c. The Contractor shall include the cost of all clearing and grubbing which might be necessary in pits or areas from which base material is obtained in the Contract price for the base in which such material is used.
- d. The clearing and grubbing of areas for obtaining stabilizing materials, where required only for the purpose of obtaining materials for stabilizing, will not be paid for separately.

##### 2. Removal of Existing Structures:

- a. Price and payment will be full compensation for all work of removal and disposal of the designated structures.
- b. When direct payment for the removal of existing structures is not provided in the Contract, the cost of removing all structures is included in the Contract price for Clearing and Grubbing or, if no item of Clearing and Grubbing is included, in the compensation for the other items covering the new structure being constructed.

##### 3. Removal of Existing Concrete Pavement:

- a. Price and payment will be full compensation for performing and completing all the work of removal and satisfactory disposal including any saw cutting required.
- b. When direct payment for the removal of existing concrete pavement is not provided in the Contract and no applicable item of excavation or embankment covering such work is included in the Contract, the Contractor shall include the costs of this work in the Contract price for the item of Clearing and Grubbing or, if no item of Clearing and Grubbing is included in the Contract, in any work, pipe or other structure for which the concrete pavement removal is required.

##### 4. Removal of Trees:

- a. Price and payment will be full compensation for complete removal and disposal of each tree counted by the Engineer pursuant to these specifications.
- b. When direct payment for the removal of trees is not provided in the Contract, the cost of removing all trees is included in the Contract price for Clearing and Grubbing or, if no item of Clearing and Grubbing is included in the Contract, in the compensation for all other items in the Contract.

##### 5. Plugging Water Wells:

- a. Price and payment will be full compensation for each type of well acceptably plugged.
- b. When direct payment for plugging water wells is not provided in the Contract, the cost plugging water wells is included in the Contract price for Clearing and Grubbing or, if no item of Clearing and Grubbing is included in the Contract, in the compensation for all other items in the Contract.

6. Mailboxes:

- a. Price and payment will be full compensation for all work and materials required, including supports and numbers.
- b. When direct payment for mailboxes is not provided in the Contract, the cost for all work and materials required, including supports and numbers, is included in the Contract price for Clearing and Grubbing or, if no item of Clearing and Grubbing is included in the Contract, in the compensation for all other items in the Contract.

7. Delivery of Salvageable Material to the Department:

- a. Price and payment will be full compensation for all work required for delivery of the materials to the Department.
- b. When the Contract does not provide direct payment for the Delivery of Salvageable Material that is to be delivered to the County, the cost of Delivery of Salvageable Material is included in the Contract price for Clearing and Grubbing or, where no item for Clearing and Grubbing is included in the Contract, in the compensation for all other items in the Contract.

8. Payment Items: Payment will be made under:

Item No.	Description	Unit
110-4-10	Remove and Dispose of Existing Curb and Gutter, Sidewalks Including Ramps and Miscellaneous Concrete in Areas Not Included in the Clearing and Grubbing Item.	SF
110-1-1	Clearing and Grubbing (Includes Removal of Existing Pavement, Sidewalks, Driveways, Drainage Structures and Pipes, Vegetation, Miscellaneous Concrete. Also Includes Tree Removal, Cherry Hedge Removal, Miscellaneous Earthwork and Saw Cutting)	LS
110-7-1A	Install New Mailbox	EA

paths, curb inlets throats and other areas as designated by the Engineer.

- 2. Quantities will be agreed upon prior to beginning work in any area in question.

B. Equipment.

- C. Provide positive means to control dust from edging and sweeping operations.

- 1. Use equipment for removal or transportation of debris or litter that precludes distribution or loss of debris or litter along the roadway.
- 2. Operate moving equipment in the same direction as the flow of traffic.

D. Method of Operation.

- 1. Do not begin work until authorized, in writing, by the Engineer. Develop a work pattern from the locations listed in the work document, unless the Engineer designates the priority of the work.
- 2. Edging – The blade of the edger must produce a clear sharp cut. The trench resulting from the actions of the cutting blade will not exceed one inch in width from the edge of the surface being edged. Do not push grass or weeds into the trench.
- 3. Vegetation - Vegetation consists of grass, weeds, or bushes up to one inch in diameter that extend beyond the normal grassed areas onto the curb, sidewalk, bike paths, or other designated areas. Uniformly cut and remove all vegetation, extending over the edge of the road, curb, sidewalk, bike paths, or other designated area to the back edge of the curb, sidewalk, bike path, or other designated area.
- 4. Sweeping - Sweep all debris (grass, weeds, soil, litter, etc.) from the curb and gutters, inlet throats and grates, sidewalks, and bike paths to produce a clean appearance. Do not use blowers in the edging, sweeping or debris removal operation. Remove and dispose of properly the soil and vegetation from the gutter or sidewalk, including joint areas.
- 5. Debris Disposal – Remove debris and/or litter produced by the edging or sweeping from the job site daily. Do not stockpile or store debris or litter on the right-of-way overnight. Dispose of all debris in accordance with local, state, and federal laws. Include the cost of disposal of the debris, litter, and vegetation trimmings in the contract unit price for edging and sweeping. Remove any debris that falls into curb and inlet structures.
- 6. Return at a later time and complete the edging and sweeping operations in areas where access

**110-32 EDGING AND SWEEPING (REV. 06-02-2015)**

A. Description.

- 1. Edge, sweep, remove and dispose of vegetation from the edge of the road, curb and gutter and sidewalk areas including, but not limited to, median island curbs, roadside curbs, the front and/or backside of sidewalks and gutters, bike

is blocked by parked vehicles or other obstructions.

7. Conduct all edging, sweeping, and disposal activities during daylight hours only, unless otherwise specified in the contract documents or approved by the Engineer. The Engineer may approve nighttime operations upon request, at no additional compensation for nighttime traffic control. The Engineer may restrict the hours of operations based on peak traffic hours, local conditions, or special events. Complete all required edging, sweeping, and disposal of debris within the limits worked by the conclusion of each workday.
8. The quality and acceptance of work will be determined by the Engineer. Re-edge or re-sweep areas that are determined to be unacceptable at no additional cost to the Department.
9. Repair or replace damage to curbs, sidewalks, pavement, or turf due to negligence to the satisfaction of the Engineer at no additional compensation.

**E. Method of Measurement.**

1. The quantities to be paid will be the total linear feet of edges of road, curb and gutter, paved shoulders, sidewalks or other areas, edged and/or swept, completed and accepted. Areas that are maintained by businesses, groups, individuals, or areas where the grass and/or weeds fail to grow sufficiently to justify performing this work will be omitted as determined by the Engineer.
2. Areas requiring more than one edging/sweeping pass to sufficiently remove the debris will not be compensated twice.

**F. Basis of Payment.**

1. Price and payment will be full compensation for all the work specified in this Article and will include all equipment, labor, materials, and incidentals necessary to complete the work.
2. No separate payment for Edging and Sweeping is included under this contract.

**120 EARTHWORK AND RELATED OPERATIONS**

**A. General**

1. Refer to Section 120, Earthwork and Related Operations for LAP (Off-System), in Appendix "C" of the Special Provisions.

**120A BASE PREPARATION FOR NEW SIDEWALK CONSTRUCTION**

**A. Description.**

1. Work under this Article includes the preparation of a stabilized foundation that meets the requirements of Section 145.04 (Subgrade) of the Public Works Manual including the addition of up to six (6) inches of imported limerock or limerock and sand fill material. This item shall be used only for areas where new sidewalk will be constructed and does not apply to the replacement of existing sidewalks.
2. The Engineer may request from an approved laboratory the necessary tests to be performed to confirm that the required material and compaction specifications are met. If the results of the tests reveal that the specifications referenced herein have not been met, the Contractor, without additional compensation, shall perform all work necessary to meet the specifications and be responsible for the costs of re-testing.

**B. Method of Measurement.**

1. The quantity to be paid for will be the area of subgrade prepared in accordance with this Article, measured in square yards, completed and accepted by the Engineer.

**C. Basis of Payment.**

1. Prices and payments will be full compensation for all labor, material, and equipment necessary to perform all work specified in this Article and in Section 145.04 of the Public Works Manual for the preparation of subgrade.
2. No separate payment will be made for Earthwork and Related Operations.

**121 FLOWABLE FILL**

**A. Description.**

1. When approved by the Engineer, furnish and place Flowable Fill per FDOT Design Standard Index 307, as an alternative to compacted soil, where compaction cannot be achieved through normal mechanical methods. Applications for this material include beddings, encasements, closures for tanks, pipes, general backfill for trenches, and other uses specified in the Plans.

**B. Materials.**

1. Meet the following requirements:

Fine Aggregate*	Section 902
Portland Cement (Types I, II, or III)	Section 921
Water	Section 923
Air Entraining Admixtures**	Section 924
Fly Ash, Slag and other Pozzolanic Materials	Section 929
*Any clean fine aggregate with 100% passing a 3/8 inch mesh sieve and not more than 15% passing a No. 200 sieve may be used.	

\*\*High air generators or foaming agents may be used in lieu of conventional air entraining admixtures and may be added at jobsite and mixed in accordance with manufacturer's recommendation.

C. Mix Design.

1. Flowable Fill is a mixture of portland cement, fly ash, fine aggregate, air entraining admixture and water. Flowable fill contains a low cementitious content for reduced strength development.
2. Submit mix designs to the Engineer for approval. The following are suggested mix guides for excavatable and non-excavatable flowable fill:

	Excavatable	Non-Excavatable
Cement Type 1	75-100 lb/yd3	75-150 lb/yd3
Fly Ash	None	150-600 lb/yd3
Water	*	*
Air**	5-35%	5-15%
28 Day Compressive Strength**	Maximum 100 psi	Minimum 125 psi**
Unit Weight (Wet)***	90-110 lb/ft3	100-125 lb/ft3
Fine Aggregate shall be proportioned to yield 1 yd3.		
*Mix designs shall produce a consistency that will result in a flowable self-leveling product at time of placement.		
**Minimum 300 psi where approved by the Engineer for use above pipe culverts having less than two feet of cover measured to top of rock base.		
***The requirements for percent air, compressive strength and unit weight are for laboratory designs only and are not intended for jobsite acceptance requirements.		

D. Production and Placing.

1. Use flowable fill manufactured at a production facility that meets the requirements of FDOT 347-3.
2. Deliver flowable fill using concrete construction equipment. Revolution counter are waived. Place flowable fill by chute, pumping or other methods approved by the Engineer. Tremie flowable fill through water.

E. Construction Requirements.

1. Use straps, soil anchors or other approved means of restraint to ensure correct alignment when flowable fill is used as backfill for pipe or where flotation or misalignment may occur.

2. Place flowable fill to the designated fill line without vibration or other means of compaction. Do not place flowable fill during inclement weather, e.g. rain or ambient temperatures below 40°F. Protect flowable fill from freezing for a period of 36 hours after placement.
3. Take all necessary precautions to prevent any damages caused by the hydraulic pressure of the fill during placement prior to hardening. Provide the means to confine the material within the designated space.

F. Acceptance.

1. Acceptance of flowable fill will be based on the following documentation and a minimum temperature of flowable fill at the point of delivery of 50°F.
2. Furnish a delivery ticket to the Engineer for each load of flowable fill delivered to the worksite. Ensure that each ticket contains the following information:
  - a. Project designation,
  - b. Date,
  - c. Time,
  - d. Class and quantity of flowable fill,
  - e. Actual batch proportions,
  - f. Free moisture content of aggregates,
  - g. Quantity of water withheld.
3. Leave the fill undisturbed until the material obtains sufficient strength. Sufficient strength, unless otherwise required by the Engineer, is 35 psi penetration resistance as measured using a hand held penetrometer in accordance with ASTM C-403. Provide a hand held penetrometer to measure the penetration resistance of the hardened flowable fill.

G. Method of Measurement

1. Flowable fill will be measured for payment in cubic yards in place, as accepted by the Engineer, when shown as a pay item in the Contract. When flowable fill is not shown as a pay item, include the cost of the work in the bid price for the appropriate item.

H. Basis of Payment.

1. When the item of flowable fill is included in the Contract, payment will be made at the Contract unit price per cubic yard. Such price and payment will include all cost of the mixture, in place and accepted, determined as specified above. No measurement and payment will be made for material placed outside the neat line limits or outside the adjusted limits, or for unused or wasted material.
2. No separate payment for Flowable Fill is included under this contract.

**160 TYPE "B" STABILIZATION (SECTION 160)**

- A. Page 188, Section 160 - Stabilizing:

1. Delete the words "bearing value" or "Limerock Bearing Ratio Method" where they occur throughout this section and substitute the words "California Bearing Ratio."
  2. Delete all contrary references to density requirements and substitute with the following:
    - a. Compaction - The density requirements for all embankment and subgrade involved in this Section shall be a minimum ninety five (95) percent for non-roadway areas and ninety eight (98) percent for roadway areas, of maximum density as determined by AASHTO T-180.
  3. Delete all mention of Bearing Value requirements entirely and substitute with the following:
    - a. California Bearing Ratio Requirements: Suitability of the soil to be compacted shall be determined by the California Bearing Ratio Test as outlined in ASTM D 1883-87. Tests shall be made on each separate course, generally before the materials have been compacted. Any areas where the materials have a C.B.R. value of less than thirty (30) at ninety five (95) percent of the maximum density as determined by AASHTO T-180 shall be stabilized (or further stabilized) as specified herein.
- B. Page 189, Subarticle 160-4.1- Commercial and Local Materials – Add the following:
1. Except that the limerock used for stabilization shall have a minimum of at least fifty (50) percent carbonates of calcium and magnesium.
- C. Page 192, Subarticle 160-7.2.1.2- Undertolerances In...; is deleted in its entirety and replaced with the following:
1. There shall be no undertolerances in the C.B.R. permitted.
- D. Page 195, Article 160-9- Basis of Payment; Is deleted in its entirety and replaced with the following:
1. Payment for stabilizing including all labor and materials shall be made at the Contract Unit Price Bid as indicated in the Bid Form of the Proposal.
  2. Such price and payments shall constitute full compensation for all work specified in this Section for Type "B" Stabilization, including furnishing, spreading and mixing of all stabilizing material required and any reprocessing of stabilization areas necessary to attain the specified bearing value.
  3. No separate payment for Type "B" Stabilization is included under this contract.

**200 LIMEROCK BASE (REV. 08-23-12)**

**A. Description.**

1. Construct a base composed of limerock material. Perform work in accordance with an approved Quality Control Plan meeting the requirements of Article 105 of these Specifications.

**B. Materials.**

1. Limerock base:
  - a. Meet the requirements of FDOT Section 911.
  - b. Produced and obtained from an FDOT approved source listed on the current FDOT Approved Aggregate Products from Mines or Terminals Listings.
2. More than one source of base rock on a single Contract may be used provided that a single source is used throughout the entire width and depth of a section of base. Obtain approval from Engineer before placing material from more than one source. Place material to ensure total thickness single source integrity at any station location of the base.
3. Intermittent placement or "Blending" of sources is not permitted.
4. Do not use any of the existing base that is removed to construct the new base.
5. Limerock is referred to hereinafter as "rock".

**C. Equipment.**

1. Use mechanical rock spreaders, equipped with a device that strikes off the rock uniformly to laying thickness, capable of producing even distribution. For crossovers, intersections and ramp areas; roadway widths of 20 feet or less; the main roadway area when forms are used and any other areas where the use of a mechanical spreader is not practicable; Contractor may spread the rock using bulldozers or blade graders.

**D. Transporting Rock.**

1. Transport the rock to its point of use, over rock previously placed if practicable, and dump it on the end of the preceding spread. Hauling and dumping on the subgrade will be permitted only when, in Engineer's opinion, these operations will not be detrimental to the subgrade.

**E. Spreading Rock.**

1. Method of Spreading:
  - a. Spread the rock uniformly.
  - b. Remove all segregated areas of fine or coarse rock and replace them with properly graded rock.
2. Number of Courses:

- a. When the specified compacted thickness of the base is greater than 6 inches, construct the base in multiple courses of equal thickness. Individual courses shall not be less than 3 inches. The thickness of the first course may be increased to bear the weight of the construction equipment without disturbing the subgrade.
3. Approval requirements for thicker lifts.
    - a. If, through field tests, Contractor can demonstrate that the compaction equipment can achieve density for the full depth of a thicker lift, and if approved by Engineer, the base may be constructed in successive courses of not more than 8 inches compacted thickness. Engineer will base approval on results of a test section constructed using Contractor's specified compaction effort as follows:
      - 1) Notify Engineer prior to beginning construction of a test section.
      - 2) Construct a test section of the length of one LOT. Perform five QC density tests at random locations within the test section. At each test site, test the bottom 6 inches in addition to the entire course thickness. All QC tests and a Department Verification test must meet the density required by the Acceptance Criteria in this Article.
      - 3) Identify the test section with the compaction effort and thickness in the Logbook. Remove the materials above the bottom 6 inches, at no expense to the Department. The minimum density required on the thicker lift will be the average of the five results obtained on the thick lift in the passing test section.
      - 4) Maintain the exposed surface as close to "undisturbed" as possible; no further compaction will be permitted during the test preparation. If unable to achieve the required density, remove and replace or repair the test section to comply with the specifications at no additional expense to the Department. Contractor may elect to place material in 6 inches compacted thickness at any time.
      - 5) Once approved, a change in the source of base material will require the construction of a new test section. Do not change the compaction effort once the test section is approved. Engineer will periodically verify the density of the bottom 6 inches during thick lift operations.
      - 6) Engineer may terminate the use of thick lift construction and instruct Contractor to revert to the 6 inches maximum lift thickness if Contractor fails to achieve satisfactory results or meet applicable specifications.
  4. Rock Base for Shoulder Pavement: Unless otherwise permitted, complete all rock base shoulder construction at any particular location before placing the final course of pavement on the traveled roadway. When dumping material for the construction of a rock base on the shoulders, do not allow material capable of scarring or contaminating the pavement surface on the adjacent pavement. Immediately sweep off any rock material that is deposited on the surface course.

F. Compacting and Finishing Base.

1. General:

- a. Perform work in accordance with an approved Quality Control Plan meeting the requirements of Article 105 of these Specifications and the Acceptance Criteria herein below.
- b. Construct mainline pavement lanes, turn lanes, ramps, parking lots, concrete box culverts and retaining wall systems in sections of not less than 300 feet in length or for the full length of the rock base. For these, a LOT is defined as a single lift of finished embankment not to exceed 500 feet.
- c. Construct shoulder-only areas, bike/shared use paths, and sidewalks in sections of not less than 300 feet in length or for the full length of the rock base. For these, a LOT is defined as 1,000 feet or one Day's Production, whichever is greater. Shoulders compacted separately shall be considered separate LOTs.

2. Single Course Base: After spreading, scarify the entire surface. Shape the base to produce the required grade and cross-section, free of scabs and laminations, after compaction.

3. Multiple Course Base: Clean the first course of foreign material, then blade and bring it to a surface cross-section approximately parallel to the finished base. Before spreading any material for the upper courses, allow Engineer to make density tests for the lower courses to determine that the required compaction has been obtained. After spreading the material for the top course, scarify finish and shape its surface to produce the required grade and cross-section, free of scabs and laminations, after compaction.

4. Moisture Content: When the material does not have the proper moisture content to ensure the required density, wet or dry it as required. When adding water, uniformly mix it in to the full depth of the course that is being compacted. During wetting or drying operations, manipulate, as a unit, the entire width and depth of the course that is being compacted.

5. Thickness Requirements: Within the entire limits of the length and width of the finished base, meet the specified plan thickness in accordance with the Quality Control requirements specified in Depth and Surface Testing Requirements subarticle herein below.

6. Correction of Defects:

- a. Contamination of Base Material: If, at any time, the subgrade material becomes mixed with the base course material, dig out and remove the mixture, and reshape and compact the subgrade. Then replace the materials removed with clean base material, and shape and compact as specified above. Perform this work at no expense to the Department.
- b. Cracks and Checks: If cracks or checks appear in the base, either before or after priming, which, in the opinion of Engineer, would impair the structural efficiency of the base, remove the cracks or checks by rescarifying, reshaping, adding base material where necessary, and recompacting.

7. Compaction of Widening Strips:

- a. Where base construction consists of widening strips and the trench width is not sufficient to permit use of standard base compaction equipment, compact the base using vibratory compactors, trench rollers or other special equipment which will achieve the density requirements specified herein.
- b. When multiple course base construction is required, compact each course prior to spreading material for the overlying course.

G. Acceptance Criteria:

- 1. Density: Within the entire limits of the width and depth of the base, obtain a minimum density in any LOT of 98% of modified Proctor maximum density as determined by FM 1-T 180, Method D. For shoulder only areas and bike/shared use paths, obtain a minimum density of 95% of the modified Proctor maximum density as determined by FM 1-T 180, Method D.
- 2. Frequency: Conduct QC sampling and testing at a minimum frequency listed in the table below. Engineer will perform Verification sampling and tests at a minimum frequency listed in the tables below.

Mainline Pavement Lanes, Turn Lanes, Ramps, Parking Lots, Concrete Box Culverts and Retaining Wall Systems		
Test Name	Quality Control	Verification
Modified Proctor Maximum Density	One per eight consecutive LOTs	One per 16 consecutive LOTs
Density	One per LOT	One per four LOTs
Roadway Surface	Ten per LOT	Witness
Roadway Thickness	Three per LOT	Witness

Shoulder-Only, Bike/Shared Use Path and Sidewalk Construction		
Test Name	Quality Control	Verification
Modified Proctor Maximum Density	One per two LOTs	One per four LOTs
Density	One per LOT	One per two LOTs
Surface	Five per 500 feet	Witness
Thickness	Three per 600 consecutive feet	Witness

3. Initial Equipment Comparison:

- a. Before initial production, perform a comparison test using the Quality Control, Verifications and Independent Assurance gauges. Unless Engineer instructs, do not perform the initial equipment comparison more than once per project. When comparing the computed dry density of one nuclear gauge to a second gauge, ensure that the difference between the two computed dry densities does not



- exceed 2 lb/ft<sup>3</sup> between gauges from the same manufacturer, and 3 lb/ft<sup>3</sup> between gauges from different manufacturers. Repair or replace any Quality Control gauge that does not compare favorably with the Independent Assurance gauge.
- b. Perform a comparison analysis between the Quality Control nuclear gauge and the Verification nuclear gauge any time a nuclear gauge or repaired nuclear gauge is first brought to the project. Repair and replace any Quality Control gauge that does not compare favorably with the Verification gauge at any time during the remainder of the project. Calibrate all Quality Control gauges annually.
4. Initial Production Lot:
    - a. Before construction of any other LOT, prepare a 500-foot initial control section consisting of one full LOT in accordance with the approved Quality Control Plan for the Project.
    - b. Notify Engineer at least 24 hours prior to production of the initial control section. Perform all QC tests required herein below. When the initial Quality Control test results pass specifications, Engineer will perform a Verification test to verify compliance with the specifications.
    - c. Do not begin constructing another LOT until successfully completing the initial production LOT. Engineer will notify Contractor of the initial production lot approval within three working days after receiving Contractor's Quality Control data when test results meet the following conditions:
      - 1) Quality Control tests must meet the specifications.
      - 2) Verification test must meet the specifications.
      - 3) Difference between Quality Control and Verification computed Dry Density results shall meet the requirements provided above for Initial Equipment Comparison.
      - 4) If Verification test result fails the density requirements of the Acceptance Criteria, correct the areas of non-compliance. The Quality Control and Verification tests will then be repeated. Engineer will reject Contractor's Quality Control Plan after three unsuccessful Verification attempts. Submit a revised Quality Control Plan to Engineer for approval.
  5. Density over 105%:
    - a. When a QC computed dry density results in a value greater than 105% of the applicable Proctor maximum dry density, Engineer will perform an Independent Verification density test within 5 feet.
    - b. If the Independent Verification density results in a value greater than 105%, Engineer will investigate the compaction methods, examine the applicable Standard Proctor Maximum Density and material description.
    - c. Engineer may collect and test an Independent Verification Standard Proctor Maximum Density sample for acceptance in accordance with the Acceptance Criteria.
  6. Quality Control Tests:
    - a. Standard Proctor Maximum Density Determination: Determine the Quality Control standard Proctor maximum density and optimum moisture content by sampling and testing the material in accordance with the specified test method listed in the Acceptance Criteria.
    - b. Density Testing Requirements: Ensure compliance to the requirements of the Acceptance Criteria by Nuclear Density testing in accordance with FM 1-T 238. Determine the in-place moisture content for each density test. Use Florida Method FM 1-T 238, FM 5-507 (Determination of Moisture Content by Means of a Calcium Carbide Gas Pressure Moisture Tester), or ASTM D-4643 (Laboratory Determination of Moisture Content of Granular Soils By Use of a Microwave Oven) for moisture determination.
    - c. Soil Classification: Perform soil classification tests on the sample collected for the Standard Proctor Maximum Density Determination above, in accordance with AASHTO T-88. Classify soils in accordance with AASHTO M-145 in order to determine compliance with embankment utilization requirements. Unless required by Engineer, do not test or classify materials for stabilized subgrade or base.
  7. Department Verification:
    - a. Engineer will conduct a Verification test(s) in order to accept all materials and work associated with the Quality Control Tests. Engineer will verify the Quality Control results if they meet the Verification Comparison Criteria, otherwise Engineer will implement Resolution procedures.
    - b. Engineer will select test locations, including Station, Offset, and Lift, using a Random Number generator based on the Lots under consideration. Each Verification test evaluates all work represented by the Quality Control testing completed in those LOTs.
    - c. In addition to the Verification testing, Engineer may perform additional Independent Verification (IV) testing. Engineer will evaluate and act upon the IV test results in the same manner as Verification test results.
    - d. When the project requires less than four Quality Control tests per material type, Engineer reserves the right to accept the materials and work through visual inspection.
  8. Reduced Testing Frequency: When no Resolution testing is required for 12 consecutive verified LOTs, or if required, the QC test data was upheld, reduce the QC density testing to one test every two LOTs by identifying the substantiating tests in the Density Log Book and notifying Engineer in writing prior to starting reduced frequency of testing. Generate random numbers based on the two LOTs under consideration. When Quality Control test frequency is reduced to one every two LOTs, obtain Engineer's approval to place more than one LOT over an untested LOT. Assure similar compaction efforts for the untested LOTs. If the Verification test fails, and Quality Control test data is not upheld by Resolution testing, the Quality Control testing will revert to the original frequency of one Quality Control test per LOT. Do not apply reduced testing frequency in construction of shoulder-only areas, bike/shared use paths and sidewalks.
  9. Quality Control Testing:

- a. Modified Proctor Maximum Density Requirement: Collect enough material to split and create three separate samples and retain two for Engineer's Verification and Resolution testing until Engineer accepts the 16 LOTs represented by the samples.
- b. Depth and Surface Testing Requirements:
  - 1) Notify Engineer a minimum of 24 hours before checking base depths and surface checking. Determine test locations including Stations and Offsets, using the Random Number generator approved by the Department. Do not perform depth and surface checks until Engineer is present to witness. Perform thickness check on the finished base or granular subbase component of a composite base. Provide traffic control, coring/boring equipment, and an operator for the coring/boring equipment. Traffic control is to be provided in accordance with the standard maintenance of traffic requirements of the Contract.
  - 2) The thickness is considered deficient, if the measured depth is over 1/2 inch less than the specified thickness. Correct all deficient areas of the completed base by scarifying and adding additional base material. As an exception, if authorized by the Department, such areas may be left in place without correction and with no payment.
  - 3) Check the finished surface of the base course with a template cut to the required crown and with a 15 foot straightedge laid parallel to the centerline of the road. Correct all irregularities greater than 1/4 inch to the satisfaction of the Engineer by scarifying and removing or adding rock as required, and recompact the entire area as specified hereinbefore.
- c. Surface & Thickness Reduced Testing Frequency: When no Resolution testing is required for 12 consecutive verified LOTs, or if required, the QC test data was upheld, reduce the QC surface and/or thickness checks to one half the minimum requirements as stated in the frequency requirements above (e.g. Reduce frequency from ten per LOT to ten per two LOTs) by identifying the substantiating tests and notifying Engineer in writing prior to starting reduced frequency of testing. If the Verification test fails, and Quality Control test data is not upheld by Resolution testing the Quality Control testing will revert to the original frequency required by the Acceptance Criteria above. The results of the Independent Verification testing will not affect the frequency of the Quality Control testing.

10. Department Verification Tests:

- a. Maximum Density: Engineer will randomly select one of the remaining two split samples and test in accordance with FM 1-T 180, Method D.
- b. Thickness and Surface Testing Requirements: The Department will witness the base depth and surface checks to ensure compliance with the Depth and Surface Testing Requirements above. If the QC test results are not deficient as defined therein, the LOT or 500-foot section will be accepted. If the QC test results are deficient, resolve deficiencies in accordance with the Depth and Surface Testing Requirements. Repeat

acceptance testing. Provide traffic control, coring/boring equipment, and an operator for the coring/boring equipment.

c. Verification Comparison Criteria and Resolution Procedures:

- 1) Modified Proctor Maximum Density: Engineer will compare the Verification test results for Maximum Density to the corresponding Quality Control test results. If the test result is within 4.5 lb/ft<sup>3</sup> of the QC test result, the LOTs will be verified. Otherwise, Engineer will collect the Resolution split sample corresponding to the Verification sample tested. The State Materials Office or an AASHTO accredited laboratory designated by the State Materials Office will perform Resolution testing. The material will be sampled and tested in accordance with FM 1-T 180, Method D.
- 2) Engineer will compare the Resolution Test results with the Quality Control test results. If the Resolution Test result is within 4.5 lb/ft<sup>3</sup> of the corresponding Quality Control test result, Engineer will use the Quality Control test results for material acceptance purposes for each corresponding set of LOTs. If the Resolution test result is not within 4.5 lb/ft<sup>3</sup> of the corresponding Quality Control test, Engineer will collect the remaining Verification split sample for testing. Verification Test results will be used for material acceptance purposes for the LOTs in question.
- 3) Density: When a Verification or Independent Verification density test does not meet the requirements of the Acceptance Criteria, retest at a site within a 5 feet radius of the Verification test location and observe the following:
  - a) If the Quality Control retest meets the Acceptance Criteria and compares favorably with the Verification or Independent Verification test, Engineer will accept the LOTs in question.
  - b) If the Quality Control retest does not meet the Acceptance Criteria and compares favorably with the Verification or Independent Verification test, rework and retest the material in that LOT. Engineer will re-verify the LOTs in question.
  - c) If the Quality Control retest and the Verification or Independent Verification test do not compare favorably, complete a new Equipment-Comparison Analysis. Once acceptable comparison is achieved, retest the LOTs. Engineer will perform new verification testing. Acceptance testing will not begin on a new LOT until Contractor has a gauge that meets the comparison requirements.
- 4) Thickness and Surface Testing Requirements: Resolve deficiencies in accordance with the Depth and Surface Testing Requirements above.

H. Priming and Maintaining.

- 1. Priming: Apply the prime coat only when the base meets the specified density requirements and when the moisture content in the top half of the base does not exceed the optimum moisture of the base material. At the time of

priming, ensure that the base is firm, unyielding and in such condition that no undue distortion will occur.

2. Maintaining: Maintain the true crown and template, with no rutting or other distortion, while applying the surface course.

I. Thickness of Base.

1. Engineer will determine, as follows, the average thickness of the compacted limerock base for use in the measurements specified in the Method of Measurement:
  - a. Average thickness will be calculated per typical cross-section for the entire job as a unit.
  - b. Any measured thickness that is more than 1/2 inch greater than the design thickness shown on the typical cross-section in the Plans or, when no plans exist, the thickness specified in the description of the Contract pay item, will be considered as the design or specified thickness plus 1/2 inch.
  - c. Any areas of existing base left in place will not be included in the calculations.

J. Method of Measurement.

1. The quantity to be paid for will be the pay area in square yards of limerock base constructed pursuant to these specifications that is measured, adjusted as specified below, and accepted by Engineer.
  - a. Normal Thickness Base: The surface area of specified normal thickness base to be adjusted will be the measured quantity as specified above, omitting any areas not accepted for payment under Subarticle 200-J.2 below, and omitting areas which are to be included for payment under the Method of Measurement for Variable Thickness Base Authorized by Engineer. The pay area is determined by adjusting the aforementioned surface area using the formula below limited to a maximum for the final pay area of 105 percent of the surface area.
    - 1)  $\text{Pay Area} = \text{Surface Area} \times ((\text{Calculated Average Thickness per these Specifications}) / (\text{Plan or Specified Thickness}))$
  - b. Variable Thickness Base Authorized by Engineer: Where the base is constructed to an authorized compacted thickness other than the normal thickness as shown on the typical section in the Plans, as specified on the Plans, the thickness specified in the description of the Contract pay item, or ordered as by Engineer for providing additional depths at culverts or bridges, or for providing transitions to connecting pavements; the volume of such authorized variable thickness compacted base will be calculated from authorized lines and grades, or by other methods selected by Engineer, and converted to equivalent square yards of normal thickness base for payment.
2. Additional areas that will not be included in the above measurements for payment include:
  - a. Areas of existing base left in place;

- b. Areas where under-thickness is in excess of the allowable tolerance as specified in Subarticle 200-G.9; and
- c. Areas where the work under other Contract pay item(s) includes the construction or restoration of a limerock base.

K. Basis of Payment.

1. Price and payment will be full compensation for all the work specified in this Article, including correcting all defective surface and deficient thickness, removing cracks and checks as provided above in Crack and Checks, prime coat application meeting the requirements of FDOT Section 300, and the additional rock required for crack elimination.
2. No separate payment for Limerock Base is included under this contract.
3. Payment Items: Payment will be made under:

Item No.	Description	Unit
200- 2-1	Base Preparation for New Sidewalk Construction	SY

**DIVISION 300 BITUMINOUS TREATMENTS SURFACE COURSES AND CONCRETE PAVEMENT**

---

**327 MILLING OF EXISTING ASPHALT PAVEMENT (REV. 05-14-12)**

A. Description.

1. At the locations and to the average depth of cut specified by the Contract Documents or Work Order, remove existing asphalt concrete pavement by milling to improve the rideability and cross slope of the finished pavement, to lower the finished grade adjacent to existing curb prior to resurfacing, or to completely remove existing pavement.
2. Take ownership of milled material.

B. Equipment.

1. Provide a milling machine capable of maintaining a depth of cut and cross slope that will achieve the results specified in the Contract Documents or Engineer. Use a machine with a minimum overall length (out to out measurement excluding the conveyor) of 18 feet and a minimum cutting width of 6 feet.
2. Equip the milling machine with a built-in automatic grade control system that can control the transverse slope and the longitudinal profile to produce the specified results.
3. To start the project, Engineer will approve any commercially manufactured milling machine that meets the above requirements. If it becomes evident after starting milling that the milling machine cannot consistently produce the specified results, Engineer will reject the milling machine for further use.
4. Contractor may use a smaller milling machine when milling to lower the grade adjacent to existing curb or other areas where it is impractical to use the above described equipment.
5. Equip the milling machine with means to effectively limit the amount of dust escaping during the removal operation.
6. For complete pavement removal, Engineer may approve the use of alternate removal and crushing equipment in lieu of the equipment specified above.

C. Construction.

1. General:
  - a. Remove the existing raised reflective pavement markers prior to milling. Include the cost of removing existing pavement markers in the price for milling.
  - b. When milling to improve rideability or cross slope, remove the existing pavement to the average depth specified by the Contract Documents or Work Order, in a manner that will restore the pavement surface to a uniform cross-section and longitudinal profile. Engineer may require the use of a stringline to ensure maintaining the proper alignment.

- c. Establish the longitudinal profile of the milled surface in accordance with the milling plans. Ensure that the final cross slope of the milled surface parallels the surface cross slope shown on the Plans or as directed by Engineer. Establish the cross slope of the milled surface by a second sensing device near the outside edge of the cut or by an automatic cross slope control mechanism. The Plans may waive the requirement of automatic grade or cross slope controls where the situation warrants such action.
- d. Operate the milling machine to minimize the amount of dust being emitted. Engineer may require prewetting of the pavement.
- e. Provide positive drainage of the milled surface and the adjacent pavement. Perform this operation on the same day as milling. Repave all milled surfaces no later than the day after the surface was milled unless otherwise stated in the plans.
- f. If traffic is to be maintained on the milled surface prior to the placement of the new asphalt concrete, provide suitable transitions between areas of varying thickness to create a smooth longitudinal riding surface. Produce a pattern of striations that will provide an acceptable riding surface. Engineer will require the control the traveling speed of the milling machine to produce a texture that will provide an acceptable riding surface.
- g. Prior to opening an area which has been milled to traffic, sweep the pavement with a power broom or other approved equipment to remove, to the greatest extent practicable, fine material which will create dust under traffic. Sweep in a manner that will minimize the potential for creation of a traffic hazard and to minimize air pollution.
- h. Sweep the milled surface with a power broom prior to placing asphalt concrete.
- i. In urban and other sensitive areas, use a street sweeper or other equipment capable of removing excess milled materials and controlling dust. Obtain Engineer's approval of such equipment, contingent upon its demonstrated ability to do the work.
- j. Perform the sweeping operation immediately after the milling operations or as directed by Engineer.

2. Quality Control Requirements:

- a. Furnish an electronic level with a length of 4 feet and an accuracy of plus or minus 0.1 degree approved by Engineer for the control of cross slope. Make this electronic level available at the jobsite at all times during milling operations. Calibrate and compare electronic levels at a minimum frequency of once per day before any milling operation, and at any time as directed by Engineer. If the comparison between the QC and Verification levels is within the comparison tolerance of plus or minus 0.2%, the QC level is considered to compare favorably and can be used for measurement and acceptance of cross slopes. If the levels do not compare favorably, perform a second comparison using another calibrated electronic level (PWMM or Contractor) for resolution. If this resolution level compares favorably with the QC level, the QC level is considered to be verified. If the second level does not compare favorably with the QC level, discontinue the use of the QC electronic level and

obtain another approved electronic level that meets the requirements of this specification. Regardless of the comparison analysis outcome, Contractor assumes all risk associated with placing the pavement at the correct cross slope.

b. Multiple cuts may be made to achieve the required pavement configuration or depth of cut. Measure the cross slope of the milled surface by placing the level at the center location of a lane and perpendicular to the roadway centerline. Record all the measurements to the nearest 0.1% on an approved form and submit to Engineer for documentation.

1) Tangent Sections: Measure the cross slope per lane at a minimum frequency of one measurement every 100 feet. Calculate the absolute deviation of cross slope at each measurement and then average the absolute deviation of ten consecutive cross slope measurements. The absolute deviation is the positive value of a deviation. When the average absolute deviation cross slope is consistently within the acceptance tolerance as shown in Table 327-1 and upon approval by Engineer, the frequency of the cross slope measurements can be reduced to one measurement every 200 feet during milling operations.

2) Superelevated Sections: Measure the cross slope every 100 feet per lane within the length of full superelevation. Calculate the absolute deviation of each measurement and then average the absolute deviation of ten consecutive cross slope measurements. For every transition section, measure the cross slope at control points identified in the plans or, if not shown in the plans, at a control point at a location of 0.0% cross slope. For curves where the length of the fully superelevated section is less than 250 feet, measure the cross slope at the beginning point, midpoint and ending point of the fully superelevated section, calculate the absolute deviation and average. When the number of measurements is less than ten and the length of full superelevation is greater than 250 feet, average the absolute deviation of all measurements.

c. If the average absolute deviation of the cross slope measurements falls outside the acceptance tolerance shown in Table 327-1, stop the milling operations and make adjustments until the problem is resolved to the satisfaction of Engineer. If an individual cross slope deviation falls outside the acceptance tolerance as shown in Table 327-1, make corrections only in the deficient area to the satisfaction of Engineer at no cost to the Department. For pavement with multiple cuts, the deficient areas not caused by the final cut may be left in place upon approval of Engineer. All milling corrections shall be completed before placement of the asphalt course unless stated otherwise in the plans or as determined by Engineer.

d. The limits of deficient areas requiring correction may be verified and adjusted with more accurate measurement methods, including survey instruments, upon approval by Engineer at no cost to the Department. Should Contractor wish to have any corrections waived, submit a request to Engineer for approval. Engineer may waive the corrections at no reduction in payment if an

engineering determination indicates that the deficiencies are sufficiently separated so as not to significantly affect the final cross slope or project grade.

e. For intersections, tapers, crossovers, transitions at the beginning and end of the project, bridge approaches and similar areas, adjust the cross slope to match the actual site conditions, or as directed by Engineer.

TABLE 327-1 Cross Slope Milling Acceptance Tolerance		
Roadway Feature	Individual Absolute Deviation	Average Absolute Deviation
Tangent section (including turn lanes)	0.4%	0.2%
Superelevated curve	0.4%	0.2%
Shoulder	0.5%	0.5%

D. Milled Surface.

1. Provide a milled surface with a reasonably uniform texture, within 1/4 inch of a true profile grade, and with no deviation in excess of 1/4 inch from a straightedge applied to the pavement perpendicular to the centerline. Ensure that the variation of the longitudinal joint between multiple cut areas does not exceed 1/4 inch. Engineer may accept areas varying from a true surface in excess of the above stated tolerance without correction if Engineer determines that they were caused by a pre-existing condition which could not have reasonably been corrected by the milling operations. Correct any unsuitable texture or profile, as determined by Engineer, at no additional expense to the Department.

2. Engineer may require remilling of any area where a surface lamination causes a non-uniform texture to occur.

E. Method of Measurement.

1. The quantity to be paid for will be the area, in square yards, over which milling is completed and accepted by Engineer.

F. Basis of Payment.

1. Price and payment will be full compensation for all work specified in this Article, including hauling off and stockpiling or otherwise disposing of the milled material.

2. No separate payment will be made for Milling of Existing Asphalt Pavement.

### 334 HOT MIX ASPHALT

#### A. Description

1. Refer to Section 334, Superpave Asphalt for LAP (Off-System), in Appendix "D" of the Special Provisions.

### 335 DRIVEWAY TRANSITIONS (REV. 06-23-11)

#### A. Description

1. General: Where required by the Contract Documents or directed by the Engineer, transition the driveway to meet the elevation of a newly constructed and abutting sidewalk or roadway.

#### B. Materials

1. Meet the following requirements:
  - a. Limerock (FDOT Section 911)
  - b. Concrete (FDOT Section 347; minimum compressive strength of 3,000 p.s.i. at 28 days)
  - c. Hot Mix Asphalt; refer to HMA Specifications in these Contract Documents.
  - d. Expansion Joints (FDOT 932-1.1)

#### C. Preparation and Construction

1. Full-depth saw cut a neat line along the entire width of the driveway where it abuts the new sidewalk or roadway and remove existing concrete or asphalt to provide for a maximum transition slope of 2" per foot.
2. Concrete Driveways:
  - a. Remove or add any additional subgrade material necessary to meet final elevation requirements.
  - b. Add the necessary amount of limerock to rework the rock base and compact to a minimum of 95% of AASHTO T 99 density.
  - c. Construct a 6" thick concrete pavement.
  - d. Form a ½ inch expansion joint between the sidewalk and the driveway or at fixed objects and driveway intersections.
  - e. Finish surface of concrete to match existing driveway.
3. Asphalt Driveways:
  - a. Remove or add any additional subgrade necessary to meet final elevation for a new 6" thick limerock base and a 1" thick Hot Mix Asphalt (HMA) pavement layer.
  - b. Provide and compact new limerock base to obtain a minimum density of 98% of modified Proctor maximum density as determined by FM 1-T 180, Method D.
  - c. Construct a minimum 1" thick HMA pavement layer (Type SP-9.5).
4. Dispose of all excess materials and debris properly.

#### D. Method of Measurement

1. The quantity to be paid for will be the area, in square yards, of approved HMA or concrete pavement transition, measured and accepted by the Engineer.

#### E. Basis of Payment

1. Price and payment will be full compensation for all work and materials specified in this Article.
2. Driveway transitions are not anticipated for this Contract. Any incidental asphalt work is to be included under the related work pay item having awarded Contract Prices measured and approved.
3. No separate payment will be made for Driveway Transitions.

### 339 MISCELLANEOUS ASPHALT PAVEMENTS (REV. 08-25-11)

#### A. Description.

1. Construct asphalt pavement in areas where vehicular traffic does not travel, such as pavement under guardrail, bicycle paths, median pavement, sidewalks, etc.
2. Chemically treat the underlying soil to prevent plant growth.

#### B. Materials.

1. Use a plant-mixed hot bituminous mixture, other than an open-graded friction course (FC-5), meeting the requirements of a mix design approved by Engineer. For bicycle paths, use a mixture that produces a finished pavement which will not distort or mar under bicycle or commercial riding mower wheel loads.

#### C. Foundation.

1. Shape the soil in areas where pavement is to be constructed to a surface true to the lines, grades and typical cross-sections shown in the Plans.
2. Compact the soil to a firm unyielding state.

#### D. Soil Treatment.

1. Immediately before placing the pavement, uniformly apply a pre-emergent herbicide to the foundation soil meeting the following requirements:
  - a. Use only products approved by the Florida Department of Agriculture for the State of Florida found on [www.flpesticide.us/](http://www.flpesticide.us/) website.
  - b. Ensure that the herbicide carries an approved label for use under paved surfaces, and that herbicide is applied in accordance with directions on the label.
  - c. Do not use any products in the sulfonyleurea family of chemicals.

2. Herbicide application by broadcast spraying is not allowed.
3. Prevent damage to any adjacent vegetation during herbicide application. Replace, at no expense to the Department, any plants damaged as the result of soil treatment outside designated areas.
4. Ensure that all employees applying insecticides and herbicides possess a current Florida Department of Agriculture Commercial Applicator license with the categories of licensure in Right-of-Way Pest Control and Aquatic Pest Control. Ensure that employees who work with herbicides comply with all applicable Federal, State, and local regulations. If application of synthetic organo-auxin herbicides is necessary, meet the requirements of Chapter 5E-2, Florida Administrative Code.

E. Placing Mixture.

1. Uniformly place the hot bituminous mixture by machine or hand methods at the rate of spread or dimensions indicated in the plans or as otherwise directed by Engineer.
2. If posts are to be constructed within the pavement area, the Contractor may cut holes for installation through the completed pavement.
3. After completing installation of posts and compaction of the backfill material, patch the area around each post with fresh hot bituminous mixture.
4. If directed by the Engineer, place miscellaneous asphalt pavement prior to placement of the final surface course.

F. Compacting Mixture.

1. Uniformly compact the hot bituminous mixture with lightweight rollers or vibratory compactors as directed by Engineer. The Contractor may use hand tamps for compaction in areas which are inaccessible to other compaction equipment.

G. Surface Requirements.

1. Provide a finished surface that is reasonably smooth, of uniform texture, and shaped so as to drain without ponding of water.
2. Upon completion of the pavement, shape the surface of the adjacent earth to match the pavement edges.

H. Method of Measurement.

1. The quantity to be paid for will be the weight, in tons, determined by an electronic weighing system as described in FDOT 320-2.2. The pay quantity will be based on the average spread rate of the area shown on the Plans or authorized by the Engineer.
2. For calculation, a weight of 100 lbs/yd<sup>2</sup> per inch thickness of asphalt will be used.
3. Prepare a Certification of Quantities for the miscellaneous asphalt pavement pay item, based on the quantity of asphalt accepted by the Engineer. The certification must be provided monthly with each payment request and

include the Contract Number, Certification Number, Certification Date, period represented by Certification, and the tons of miscellaneous asphalt pavement for the period.

I. Basis of Payment.

1. Price and payment will be full compensation for all work specified in this Article, including shaping and compacting the foundation, soil sterilization treatment, furnishing of the bituminous material used in the mixture, and shaping of adjacent earth surfaces.
2. No items for this type of work are anticipated for this Contract. Any incidental asphalt work is to be included under the related work pay item having awarded Contract Prices measured and approved.

**344 CONCRETE FOR LAP (OFF-SYSTEM)**

A. Description

1. Refer to Section 344, Concrete for LAP (Off-System), in Appendix "E" of the Special Provisions.

Item No.	Description	Unit
422-6-1F	Adjust Water Meter Box. Single or Dual Services	EA

**425 INLETS, MANHOLES AND JUNCTION BOXES  
(SECTION 425)**

- A. Page 417, Subarticle 425-6.6 - Placing Pipe; The third sentence of this sub-article is modified to read:
  - 1. When catch basins are called for, the inlet and outlet pipe may extend into the structure not to exceed 4 inches beyond the interior face of the wall.
- B. Page 417, Subarticle 425-6.7 Backfilling; is modified to include the following:
  - 1. Select material shall be used for backfill adjacent to catch basins and riser inlets, as detailed in the Plans. It shall consist of well-graded limerock or limerock and sand fill. Sand or fill having a high proportion of sand will not be accepted as select fill. All select fill shall be approved by the Engineer prior to placing. No separate payment will be made for select fill, but shall be included in the unit bid price for each particular item as indicated in the Bid Form of the Proposal.
- C. Page 417, Subarticle 425-8.2 - Adjusted Structures; is expanded to include the following:
  - 1. Upon completion of the work, and prior to acceptance and final payment, all such structures will be inspected by the Engineer to ensure that they are free of all debris and thoroughly cleaned. All drainage structures within the project limits shall be cleaned thoroughly and made free of all debris prior to final acceptance by the County. The Contractor shall include within the scheduled items listed on the Contract's Bid Form, the cost of all work necessary for cleaning and debris removal.
- D. Page 418, Subarticle 425-8.3 – Payment Items; is expanded to include the following:
  - 1. When a separate item is listed on the Bid Form for cleaning of structures, said item shall only be used when indicated on the Engineering Plans or as directed by the Engineer, and only for the cleaning of drainage structures that were not impacted by construction activities.
  - 2. No separate payment for Inlets, Manholes, and Junction Boxes is included under this contract.

**425A ADJUSTMENT OR RELOCATION OF VALVE, METER AND JUNCTION BOXES**

- 1. The work under these pay items includes any adjustments (raising or lowering) of existing boxes or fire hydrants. When relocation of the box is required, the Contractor shall make all necessary arrangements with the utility companies, as the utility companies are responsible to relocate the valves and meters and valve and meter boxes.
- 2. Payment Items: Payment will be made under:

**430 PIPE CULVERTS (REV. 01-12-16)**

- A. Description.
  - 1. Furnish and install drainage pipe and end sections at the locations called for in the Plans or as directed by Engineer. Furnish and construct joints and connections to existing pipes, catch basins, inlets, manholes, walls, etc., as may be required to complete the work.
  - 2. Construct structural plate pipe culverts or underdrains in accordance with FDOT Sections 435 and 440.
  - 3. Obtain pipe culverts from a Producer currently on the FDOT's list of Producers with Accepted Quality Control Programs. Producers seeking inclusion on the list shall meet the requirements of FDOT 105-3.
  - 4. When the producer's FDOT Quality Control Program is suspended, accept responsibility of either obtaining drainage products from another producer with an accepted FDOT Quality Control Program or await re-approval of the producer's FDOT Quality Control Program. Engineer will not allow changes in Contract Time or completion dates as a result of the producer's FDOT Quality Control Program suspension. Accept responsibility for all delay costs or other costs associated with the producer's FDOT Quality Control Program suspension.
- B. Materials.
  - 1. Pipe: Meet the following requirements:
 

Concrete Pipe	FDOT Section 449
Round Rubber Gaskets	FDOT Section 942
Corrugated Steel Pipe and Pipe Arch	FDOT Section 943
Corrugated Aluminum Pipe and Pipe Arch	FDOT Section 945
Corrugated Polyethylene Pipe	FDOT Section 948
Polyvinyl Chloride (PVC) Pipe	FDOT Section 948
  - 2. Joint Materials: Use joint materials specified in this Article according to type of pipe and conditions of usage.
  - 3. Mortar: Use mortar composed of one part portland cement and two parts of clean, sharp sand, to which mixture Contractor may add hydrated lime in an amount not to exceed 15% of the cement content. Use mortar within 30 minutes after its preparation.
- C. Type of Pipe to Be Used.
  - 1. When the Plans designate a type (or types) of pipe, use only the type (or choose from the types) designated.



2. If the Plans do not designate a type (or types) of pipe, Contractor, subject to Engineer's approval, may use either a minimum Class I concrete pipe, corrugated steel pipe, corrugated aluminum pipe, corrugated polyethylene pipe or PVC pipe. If one of the metal types is chosen, use the minimum gage specified in FDOT Section 943 for steel pipe or FDOT Section 945 for aluminum pipe.
3. Class I corrugated Polyethylene Pipe may be used on local (non-arterial or non-collector) roads only.

D. Laying Pipe.

1. General:

- a. Lay all pipe, true to the lines and grades given, with hubs upgrade and tongue end fully entered into the hub. When pipe with quadrant reinforcement or circular pipe with elliptical reinforcement is used, install the pipe in a position such that the manufacturer's marks designating "top" and "bottom" of the pipe are not more than five degrees from the vertical plane through the longitudinal axis of the pipe. Do not allow departure from and return to plan alignment and grade to exceed 1/16 inch per foot of nominal pipe length, with a total of not more than 1-inch departure from theoretical line and grade. Take up and relay any pipe that is not in true alignment or which shows any settlement after laying at no additional expense to the Department.
- b. Do not use concrete pipe with lift holes except round pipe which has an inside diameter in excess of 54 inches or any elliptical pipe.
- c. Repair lift holes, if present, by use of a hand-placed, stiff, non-shrink, 1-to-1 mortar of cement and fine sand, after first washing out the hole with water. Completely fill the void created by the lift hole with mortar. Cover the repaired area with a 24 by 24 inches piece of filter fabric secured to the pipe. Use a Type D-3 filter fabric meeting the requirements shown on FDOT Design Standards, Index 199 and the Contract Documents.
- d. Secure the filter fabric to the pipe using a method that holds the fabric in place until the backfill is placed and compacted. Use a grout mixtures, mastics, or strapping devices to secure the fabric to the pipe.
- e. When installing pipes in structures, construct inlet and outlet pipes of the same size and kind as the connecting pipe shown in the Plans. Extend the pipes through the walls for a distance beyond the outside surface sufficient for the intended connections, and construct the concrete around them neatly to prevent leakage along their outer surface as shown on the FDOT Design Standards, Index 201. Keep the inlet and outlet pipes flush with the inside of the wall. Resilient connectors as specified in FDOT 942-3 may be used in lieu of a masonry seal.
- f. Furnish and install a filter fabric jacket around all pipe joints and the joint between the pipe and the structure in accordance with FDOT Design Standards, Index Nos. 201 and 280. Use fabric meeting the physical requirements of Type D-3 specified on the FDOT Design Standards, Index 199 and the Contract Documents. The fabric shall extend a minimum of 12 inches beyond each side of the joint or both edges of the coupling band, if a coupling band is used. The fabric shall have a minimum width of 24 inches, and a length

sufficient to provide a minimum overlap of 24 inches. Secure the filter fabric jacket against the outside of the pipe by metal or plastic strapping or by other methods approved by Engineer.

g. Meet the following minimum joint standards:

Pipe Application	Minimum Standard
Storm and Cross Drains	Water-tight
Gutter Drain	Water-tight
Side Drains	Soil-tight

- h. When rubber gaskets are to be installed in the pipe joint, the gasket shall be the sole element relied on to maintain a tight joint. Soil tight joints must be watertight to 2 psi. Water-tight joints must be water-tight to 5 psi unless a higher pressure rating is required in the Plans.
2. Trench Excavation: Excavate the trench for storm and cross drains, and side drains as specified in the Contract Documents.
3. Foundation: Provide a suitable foundation, where the foundation material is of inadequate supporting value, as determined by Engineer. Remove the unsuitable material and replace it with suitable material, as specified in Article 120 (Earthwork and Related Operations) of these Specifications. Where in Engineer's opinion, the removal and replacement of unsuitable material is not practicable, he may direct alternates in the design of the pipe line, as required to provide adequate support. Minor changes in the grade or alignment will not be considered as an adequate basis for extra compensation. Do not lay pipe on blocks or timbers, or on other unyielding material, except where the use of such devices is called for in the Plans.
4. Backfilling: Backfill around the pipe as specified in Article 120 (Earthwork and Related Operations) of these Specifications unless specific backfilling procedures are described in the Contract Documents.
5. Plugging Pipe:
  - a. When existing pipe culverts are to be permanently placed out of service, fill them with flowable fill that is non-excavatable, contains a minimum 350 lbs/cy of cementitious material and meets the requirements Article 121 (Flowable Fill) and/or plug them with masonry plugs as required by the Contract Documents. Install masonry plugs that are a minimum of 8 inches in thickness, in accordance with FDOT Design Standards Index 280.
  - b. When proposed or existing pipe culverts are to be temporarily placed out of service, plug them with prefabricated plugs as shown in the Plans. Install prefabricated plugs in accordance with the manufacturer's recommendations. Do not fill, or construct masonry plugs in, any pipe culverts intended for current or future service.
6. End Treatment:
  - a. Place an end treatment at each storm and cross drain, and side drain as shown in the Plans. Refer to the FDOT Design Standards for types of end treatment details.

- b. As an exception to the above, when concrete mitered end sections are permitted, Contractor may use reinforced concrete U-endwalls, if shop drawings are submitted to Engineer for approval prior to use.
  - c. Provide end treatments for corrugated polyethylene pipe and PVC pipe as specified in FDOT Section 948, or as detailed in the Plans.
7. Metal Pipe Protection:
- a. Apply a bituminous coating to the surface area of the pipe within and 12 inches beyond the concrete or mortar seal prior to sealing, to protect corrugated steel or aluminum pipe embedded in a concrete structure, such as an inlet, manhole, junction box, endwall, or concrete jacket.
  - b. Ensure that the surface preparation, application methods (dry film thickness and conditions during application), and equipment used are in accordance with the coating manufacturers' published specifications.
  - c. Obtain Engineer's approval of the coating products used.
8. Final Pipe Inspection:
- a. Pipe must be lay under direct supervision of Engineer at all times. In the event that a specific job site requires a video inspection, and it is approved by Engineer, pipe must be inspected as per FDOT Article 430-4.8. County will pay for the cost of inspection and report.
- E. Removing Existing Pipe.
- 1. If the Plans indicate that existing pipe is to remain the property of the Department, collect and stack along the right-of-way all existing pipe or pipe arch so indicated in the Plans to be removed, or that does not conform to the lines and grades of the proposed work and that is not to be re-laid, as directed by Engineer. Take care to prevent damage to salvageable pipe during removal and stacking operations.
- F. Placing Pipe Under Railroad.
- 1. General: Construct pipe culverts under railroad tracks in accordance with the requirements of the railroad company. Perform all the shoring under the tracks, and sheeting and bracing of the trench, required by the railroad company or deemed necessary by Engineer in order to ensure safe and uninterrupted movement of the railroad equipment, at no expense to the Department.
  - 2. Requirements of the Railroad Company:
    - a. Install pipe using methods required by the railroad company and shown in the Contract Documents.
    - b. When the general method of installation required by the railroad company is indicated in the Plans, do not alter such method, or any other specific details of the installation which might be indicated in the Plans, without receiving approval or direction from the railroad, followed by written approval from Engineer.
  - 3. Notification to Railroad Company: Notify the railroad company and Engineer at least ten days prior to the date on which pipe is to be placed under the railroad tracks.
- 4. Placing Pipe by Jacking: Obtain Engineer's and the railroad company's approval of the details of the jacking method to be used, when placing pipe through the railroad embankment, before the work is started.
  - 5. Use of Tunnel Liner: When the railroad company requires that a tunnel liner be used for placing the pipe in lieu of the jacking method, the Department will pay for the tunnel liner material separately in cases where the Contract Documents do not require the use of a tunnel liner. For these cases the Department will reimburse Contractor for the actual cost of the liner, delivered at the site. The Department will base such cost on a liner having the minimum gage acceptable to the railroad.
- G. Specific Requirements for Concrete Pipe.
- 1. Sealing Joints: Seal the pipe joints with round rubber or profile gaskets meeting the requirements of FDOT Section 449. Ensure that the gasket and the surface of the pipe joint, including the gasket recess, are clean and free from grit, dirt and other foreign matter, at the time the joints are made. In order to facilitate closure of the joint, application of a vegetable soap lubricant immediately before closing of the joint will be permitted. Prelubricated gaskets may be used in lieu of a vegetable soap lubricant when the lubricating material is certified to be inert with respect to the rubber material.
  - 2. Laying Requirements for Concrete Pipe with Rubber Gasket Joints: Do not allow the gap between sections of pipe to exceed 5/8 inch for pipe diameters of 12 inches through 18 inches, 7/8 inch for pipe diameters of 24 through 66 inches, and 1 inch for pipe diameters 72 inches and larger. Where minor imperfections in the manufacture of the pipe create an apparent gap in excess of the tabulated gap, Engineer will accept the joint provided that the imperfection does not exceed 1/3 the circumference of the pipe, and the rubber gasket is 1/4 inch or more past the pipe joint entrance taper. Where concrete pipes are outside of these tolerances, replace them at no expense to the Department. Do not apply mortar, joint compound, or other filler to the gap which would restrict the flexibility of the joint.
  - 3. Field Joints for Elliptical Concrete Pipe: Use either a preformed plastic gasket material or an approved rubber gasket to make a field joint.
    - a. Plastic Gasket. For field joints that are made from preformed plastic gasket material; install field joints in accordance with the manufacturer's instructions and the following:
      - 1) Material: Meet the requirements of FDOT 942-2.
      - 2) Joint Design: Ensure that the pipe manufacturer furnishes Engineer with details regarding configuration of the joint and the amount of gasket material required to affect a satisfactory seal. Do not brush or wipe joint surfaces which are to be in contact with the gasket material with a cement slurry. Fill minor voids with cement slurry.
      - 3) Primer: Apply a primer of the type recommended by the manufacturer of the gasket material to all joint surfaces which are to be in contact with the gasket

material, prior to application of the gasket material. Thoroughly clean and dry the surface to be primed.

- 4) Application of Gasket: Apply gasket material to form a continuous gasket around the entire circumference of the leading edge of the tongue and the groove joint, in accordance with the detail shown on the Design Standards, Index No. 280. Do not remove the paper wrapper on the exterior surface of the gasket material until immediately prior to joining of sections. Apply plastic gasket material only to surfaces which are dry. When the atmospheric temperature is below 60°F, either store plastic joint seal gaskets in an area above 70°F, or artificially warm the gaskets to 70°F in a manner satisfactory to Engineer.

- 5) Installation of Pipe: Remove and reposition or replace any displaced or contaminated gasket as directed by Engineer. Install the pipe in a dry trench. Carefully shape the bottom of the trench to minimize the need for realignment of sections of pipe after they are placed in the trench. Hold to a minimum any realignment of a joint after the gaskets come into contact. Prior to joining the pipes, fill the entire joint with gasket material and ensure that when the pipes are joined there is evidence of squeeze-out of gasket material for the entire internal and external circumference of the joint. Trim excess material on the interior of the pipe to provide a smooth interior surface. If a joint is defective, remove the leading section of pipe and reseal the joint.

- b. Rubber Gasket. For field joints that are made with profile rubber gaskets; install field joints in accordance with the manufacturer's instructions and the following:

- 1) Material: Meet the requirements of FDOT 942-4.
- 2) Joint Design: Ensure that the pipe manufacturer furnishes Engineer with details regarding configuration of the joint and gasket required to effect a satisfactory seal. Do not apply mortar, joint compound, or other filler which would restrict the flexibility of the gasket joint.

#### 4. Requirements for Concrete Radius Pipe:

- a. Design: Construct concrete radius pipe in segments not longer than 4 feet (along the pipe centerline), except where another length is called for in the Contract Documents. Join each segment using round rubber gaskets. Ensure that the pipe manufacturer submits details of the proposed joint, segment length and shape for approval by Engineer, prior to manufacture.
- b. Pre-Assembly: Ensure that the manufacturer pre-assembles the entire radius section in his yard, in the presence of Engineer, to ensure a proper fit for all parts. At the option of the manufacturer, Contractor may assemble the pipe without gaskets. Consecutively number the joints on both the interior and exterior surfaces of each joint, and make match marks showing proper position of joints. Install the pipe at the project site in the same order as pre-assembly.

#### H. Specific Requirements for Corrugated Metal Pipe.

##### 1. Field Joints:

##### a. General:

- 1) Make a field joint with locking bands, as specified in Article 9 of AASHTO M 36 and AASHTO M 196M for aluminum pipe. For aluminum pipe, fabricate bands from the same alloy as the culvert sheeting.
- 2) When existing pipe to be extended is helically fabricated, make a field joint between the existing pipe and the new pipe using one of the following methods:

- a) Cut the new pipe to remove one of the re-rolled annular end sections required in FDOT Sections 943 or 945, or fabricate the pipe so that the re-rolled annular section is fabricated only on one end. Use either a spiral (helical) band with a gasket or a flat band with gaskets as required by Subarticle 430-H.1.b.1) b) to join the pipe sections.
- b) Contractor may construct a concrete jacket as shown on the FDOT Design Standards, Index No. 280, provided that the minimum cover required by the FDOT Design Standards, Index No. 205 can be obtained.

- b. Side Drain, Storm and Cross Drain, and Gutter Drains: Where corrugated metal pipe is used as side drain, storm and cross drain, or gutter drain, use a rubber or neoprene gasket of a design shown to provide a joint as specified in Subarticle 430-D.

##### 1) Use a gasket of one of the following dimensions:

- a) For annular joints with 1/2 inch depth corrugation: either a single gasket a minimum of 7 inches by 3/8 inch or two gaskets a minimum of 3 1/2 inches by 3/8 inch; and for annular joints with 1 inch depth corrugations: either a single gasket a minimum of 7 inches by 7/8 inch or two gaskets a minimum of 3 1/2 inches by 7/8 inch.
- b) For helical joints with 1/2 inch depth corrugation: either a single gasket a minimum of 5 inches by 1 inch or two gaskets a minimum of 3 1/2 inches by 1 inch; and for helical joints with 1 inch depth corrugations: either a single gasket a minimum of 5 inches by 1 1/2 inches or two gaskets a minimum of 3 1/2 inches by 1 1/2 inches.
- c) Such other gasket designs as may be approved by Engineer.

- 2) If, in lieu of a single gasket spanning the joint, two gaskets are used, place these individual gaskets approximately 2 inches from each pipe end at the joint. When two gaskets are used, seal the overlapping area on the coupling band between the gaskets consistent with the joint performance specified. Contractor may tuck a strip of preformed gasket material over the bottom lip of the band for this purpose. Use coupling bands that provide a minimum circumferential overlap of 3 inches. As the end connections on the coupling band are tightened, ensure that there is no local bending of the band or the connection. Use recurved coupling bands on pipe diameters of 24 inches or less.

- 3) Use flat gaskets meeting the requirements of ASTM D-1056, designation 2C2 or 2B3. In placing flat

gaskets on pipe prior to placing the coupling band, do not stretch the gasket more than 15% of its original circumference. Use circular gaskets meeting the requirements of ASTM C-361. Do not stretch the circular gasket more than 20% of its original circumference in placing the gasket on pipe. Use preformed plastic gasket material meeting the composition requirements of FDOT 942-2.2.

- 4) Apply an approved vegetable soap lubricant, as specified for concrete pipe in Subarticle 430-G.1.
- c. Alternate Joint: In lieu of the above-specified combination of locking bands and flat gaskets, Contractor may make field joints for these pipe installations by the following combinations:

- 1) Use the metal bands as specified in Article 9 of AASHTO M 36M that are at least 10 1/2 inches wide and consist of a flat central section with a corrugated section near each end, designed to match the annular corrugation in the pipe with which they are to be used. Connect the bands in a manner approved by Engineer, with a suitable fastening device such as the use of two galvanized 1/2 inch diameter bolts through a galvanized bar and galvanized strap, suitably welded to the band. Use a strap that is the same gage as the band.
- 2) Where helically corrugated pipe is to be jointed by this alternate combination, ensure that at least the last two corrugations of each pipe section are annular, and designed such that the band will engage each pipe end with the next-to-outside annular corrugation.
- 3) For these bands, use a rubber gasket with a circular cross-section of the "O-ring" type conforming to ASTM C-361. Use gaskets having the following cross-sectional diameter for the given size of pipe:

<u>Pipe Size</u>	<u>Gasket Diameter</u>
12 inches through 36 inches (with 1/2 inch depth corrugations)	13/16 inch
42 inches through 96 inches (with 1/2 inch depth corrugations)	7/8 inch
36 inches through 120 inches (with 1 inch depth corrugations)	1 3/8 inches

- 4) Use preformed gasket material to seal the overlapping area on the coupling band between gaskets.
- 5) Use channel band couplers in helical pipe with ends which have been reformed and flanged specifically to receive these bands. Use channel band couplers that are of a two piece design, are fabricated from galvanized steel stock conforming to AASHTO M 36, have 2 by 2 by 3/16 inch angles fastened to the band ends to allow for proper tightening, and meet the following:

<u>Band Thickness</u>	<u>Pipe Wall Thickness</u>
0.079 inch	0.109 inch or lighter

0.109 inch	0.138 inch or heavier
3/4 inch wide	0.109 inch or lighter
1 inch wide	0.138 inch or heavier

- 6) Furnish two 1/2 inch diameter connection bolts with each band, that conform to ASTM A-307, Grade A and are electroplated in accordance with ASTM B-633.
- 7) Use a gasket with the joint that is a hydrocarbon blend of butyl rubber meeting the chemical composition and physical properties of FDOT 942-2.2. Use a 3/8 by 3/4 inch gasket for pipe fabricated from 0.109 inch or lighter material and a 3/8 by 1 inch gasket for pipe fabricated from 0.138 inch and heavier material.
- 8) Contractor may use a flange band coupler without the gasket for all applications other than side drain, storm and cross drain, and gutter drain.
- 9) Do not use the flange band coupler to join dissimilar types of pipe.
- 10) Contractor may join reformed flanged helical pipe to existing annular or reformed pipe having annular ends. On non-gasketed installations, use either an annular band or an alternate joint described in Subarticle 430-H.1.c. On gasketed installations, use an annular band, minimum of five corrugations in width, in conjunction with two O-ring gaskets as specified in Subarticle 430-H.1.c. Use mastic material to seal the area of band overlap.
- 11) The minimum joint performance standards specified in Subarticle 430-D.1 applies.

2. Laying and Shape Requirements for Corrugated Metal Pipe: Install pipe using either a trench or open ditch procedure.

- a. Check pipe shape regularly during backfilling to verify acceptability of the construction method used. Pipe deflected 5% or more of the certified actual mean diameter of the pipe shall be replaced at no cost to the Department. Deflection measurements are taken at the point of smallest diameter on the corrugations.

I. Specific Requirements for Corrugated Polyethylene Pipe and Polyvinyl Chloride (PVC) Pipe.

1. Field Joints: Use gasketed joints to seal side drain, and storm and cross drain. Use gaskets meeting the requirements of FDOT Section 449. Ensure that the pipe manufacturer provides a joint design approved by Engineer before use.
2. Installation Requirements Including Trenching, Foundation and Backfilling Operations: Check structure shape regularly during backfilling to verify acceptability of the construction method used.
3. Pipe deflected 5% or more of the certified actual mean diameter of the pipe shall be replaced at no cost to the Department.

J. Desilting Pipe Culverts, Box Culverts, and Inlet Structures.

1. Description. Completely remove and dispose of silt, debris, vegetation, soil, rock, and any type of blockage inside existing pipe culvert(s), box culvert(s) or inlet structure(s) specified in the Contract Documents or directed by Engineer.
2. General.
  - a. Access to the pipe or box culvert may require temporary removal of fence, signs, guardrail, grates or manhole covers.
  - b. Clean the existing pipe or box culvert by completely removing all of the silt, debris, vegetation, soil, rock, and any type of blockage to restore the hydraulic conveyance design capacity of the pipe or box culvert.
  - c. Clean the existing inlet structure by completely removing all of the silt, debris, vegetation, soil, rock, and any type of blockage.
  - d. Perform desilting operations in a manner not to damage the pipe culverts, box culverts, and inlet structures or surrounding area.
  - e. Meet the requirements of Federal, State and local environmental standards and laws when performing all activities.
  - f. Meet the requirements of Article 104 of these Specifications (Prevention, Control, and Abatement of Erosion and Water Pollution).
  - g. Identify and report to Engineer necessary repairs to the pipes or box culverts and structures exposed during the desilting operation.
  - h. Pipe or Box Culverts:
    - 1) Replace according to Department standards at the completion of the desilting operation or each day, as appropriate for safety.
    - 2) Align infall and outfall ditches 50 feet from the pipe or box culvert to meet the existing line and grade. If the Right-of-Way line is less than 50 feet from the pipe or box culvert, align infall and outfall ditches to the Right-of-Way line. Grade and sod any disturbed areas caused by the desilting operation.
    - 3) Dispose of all silt and debris removed in the desilting operations in areas meeting Federal, State and local rules and regulations.
    - 4) Repair or replace damage to turf, pavement, signs or structures, etc. due to negligence to the satisfaction of Engineer at no additional cost to the Department. Complete repairs prior to submission of the invoice for work accomplished.
3. Inspection.
  - a. When directed by Engineer, de-water the pipe or box culvert to facilitate inspection.
  - b. Re-clean culverts and structures determined to be unacceptable by Engineer within the time directed at no additional cost to the Department.
- K. Method of Measurement.
  1. General:
    - a. The quantity to be paid for will be the number completed pursuant to these specifications that is measured and accepted by Engineer.
    - b. Only items of work required by this Article that have a Contract Unit Price will be measured by Engineer for payment. All other work described in this Article that is required by the Contract Documents but does not have a Contract Unit Price is considered incidental to the Work and its costs are included among the various scheduled items of the Contract.
  2. New Pipe: The quantities of storm and cross drain pipe, storm drain trench, side drain pipe and gutter drain pipe to be paid for will be quantity, measured in place and accepted by Engineer. The quantity of pipe will be measured from the inside wall of the structure, along the centerline of the pipe.
  3. Mitered End Section: The quantity to be paid for will be the number completed and accepted.
  4. Desilting Pipe Culverts, Box Culverts, and Inlet Structures:
    - a. General:
      - 1) The cost of temporary removal and subsequent replacement of fence, signs, guardrail, grates or manhole covers will be included in the contract unit price for the related item.
      - 2) Infall and outfall ditch alignment, grading and sodding will be included in the contract unit price of the related item.
      - 3) Pipes or structures that are impacted by the Work must be cleaned at no cost to the County and will not be measured for payment.
    - b. Desilting Pipe Culverts: The quantities for payment will be the length in feet of existing pipe desilted and accepted by Engineer.
    - c. Desilting Box Culverts: The quantities for payment will be the volume in cubic yard of material removed from the existing box culvert as measured and accepted by Engineer.
    - d. Desilting Structures: The quantities for payment will be the number of existing Inlet Structures desilted and cleaned as counted and accepted by Engineer.
- L. Basis of Payment.
  1. General:
    - a. Prices and payments will be full compensation for all work specified in this Article including:
      - 1) All excavation except the volume included in the items for the grading work on the Project, and except for other items specified for separate payment in Article 120 (Earthwork And Related Operations) of these Specifications;
      - 2) All backfilling material and compaction; disposal of surplus material; and
      - 3) All clearing and grubbing outside of the required limits of clearing and grubbing as shown in the Plans.

2. Removing Existing Pipe: When existing pipe is removed and replaced with new pipe approximately at the same location, the cost of excavating and removing the old pipe and of its disposal will be included in the Contract unit price for clearing and grubbing.
3. Site Restoration: The cost of completely restoring the areas of the Project Site that is disturbed for the purpose of constructing pipe culvert is included in the Contract unit price for the pipe culvert, unless designated specifically to be paid for under other items.
4. Plugging Pipes:
  - a. The cost of temporarily plugging a pipe culvert, either proposed or existing, will be incidental to the contract unit price for new pipe culvert.
  - b. The cost of filling and/or plugging an existing pipe culvert that is to be permanently placed out of service will be paid for at the contract unit price for filling and plugging pipe, per cubic yard. Price and payment will be full compensation for flowable fill, masonry, concrete, mortar, and all labor and materials necessary to complete the work.
5. Desilting Pipe Culverts, Box Culverts, and Drainage Structures: Price and payment will be full compensation for furnishing all equipment, tools, labor, removal and disposal of silt, debris, vegetation, soil, rock, and any type of blockage, de-watering, erosion and water pollution control, clean up and all incidentals necessary for the satisfactory performance of the work.
6. Flared End Sections: Price and payment will be full compensation for all work and materials required.
7. Mitered End Sections: Price and payment will be full compensation for all pipe, grates when required, fasteners, reinforcing, connectors, anchors, concrete, sealants, jackets and coupling bands, and all work required.
8. Railroad Requirements:
  - a. Where pipe culvert is constructed under railroad tracks, the Contract unit price for the pipe culvert will include the costs of any jacking operations and the operation of placing the pipe by use of a tunnel liner, (except as specified for unanticipated tunnel liner, in Subarticle 430-F.5, where reimbursement is to be made for such unanticipated liner), and all other work necessary to meet the requirements of the railroad company, excluding the costs of watchman or flagman services provided by the railroad company, except as provided below.
  - b. The Department will reimburse Contractor for the actual costs of any trestle bridge work which is performed by the railroad's forces, as billed to him by the railroad, less the value of any salvage materials derived there from, whether such salvage materials are retained by the railroad company or by Contractor. When the work of shoring and bracing is to be performed by the railroad, such fact will be stipulated in the Contract Documents and Contractor will be required to pay to the railroad the amount of such costs, which amount will be reimbursed to him by the Department. The Contract unit price for the pipe culvert shall include the costs of all other work of shoring and bracing.

9. Payment Items:

- a. No separate payment for Pipe Culverts is included under this contract.

**443 FRENCH DRAINS**

A. Description.

1. Construct french drains, utilizing one of the authorized types of pipes listed below, with coarse aggregate, and plastic filter fabric (geotextile). Construct in accordance with FDOT Design Standards, Index No. 285 as modified by or otherwise specified in the Contract Documents.

B. Materials.

1. Pipe: Unless a particular type is specified in the Contract Documents, pipe furnished may be any of the following types:
  - a. Concrete Pipe (Bell & Spigot): Slotted or perforated concrete pipe may be used.
    - 1) Meet the requirements of FDOT 449 for concrete pipe. Use the class of pipe specified on the FDOT Design Standards, Index No. 205. Do not use gaskets. Fully insert the spigot in the bell, and bring home. Conform to FDOT Design Standards, Index No. 285 for slotted pipe. Use perforated pipe having perforations equally located 360 degrees around the pipe.
    - 2) Furnish pipe having not less than 30 round perforations, 3/8 inch each, per square foot of inside pipe surface. Extend perforations to within 6 inches of the bell or spigot area. The Engineer will permit other perforations not less than 5/16 inch nor more than 3/8 inch in the least dimension if they provide an opening area not less than 3.31 in<sup>2</sup>/ft<sup>2</sup> of pipe surface.
  - b. Corrugated Aluminum Alloy Culvert Perforated Pipe:
    - 1) Meet the requirements of FDOT 945. Use perforated pipe having perforations equally located 360 degrees around the pipe. Locate perforations either on the inside crests or on the neutral axis of all corrugations except that perforations are not required within 4 inches of each end of each length of pipe or in a corrugation where seams are located.
    - 2) Furnish pipe having not less than 30 round perforations, 3/8 inch each, per square foot of pipe surface. The Engineer will permit other perforations not less than 5/16 inch nor more than 3/8 inch in the least dimension if they provide an opening area not less than 3.31 in<sup>2</sup>/ft<sup>2</sup> of pipe surface.
  - c. Corrugated Steel Perforated Pipe: Meet the requirements of FDOT 943. Space the perforations and meet the requirements as specified in b. 2) above.
  - d. Bituminous Coated Corrugated Steel Perforated Pipe: Meet the requirements of FDOT 943. Space the perforations and meet the requirements as specified in b. 2) above. Place the perforations prior to the bituminous coating. The Engineer will accept the

minimum opening of not less than 3.31 in<sup>2</sup>/ft<sup>2</sup> of pipe if 50% of the opening area is maintained after coating.

e. Corrugated Polyethylene Pipe:

1) Meet the requirements of FDOT 948-2.3 except that Class I corrugated Polyethylene Pipe may only be used on local roads (non-arterial or non-collector).

2) Space the perforations and meet the requirements as specified in b. 2) above.

f. Polyvinyl Chloride (PVC) Pipe: Meet the requirements of FDOT 948-1.7. Space the perforations and meet the requirements as specified in b. 2) above.

2. Coarse Aggregate: No. 4 limestone aggregate meeting the requirements of FDOT 901. Aggregates must be an approved product from an approved source listed on the current FDOT Approved Aggregate Products from Mines or Terminals Listings.

3. Select Fill: Use select fill meeting the requirements of either FDOT 911, 913, 913A or 915.

C. Excavating Trench.

1. Excavate the trench in accordance with the Contract specifications for Earthwork and Related Operations (hereinafter referred to as Earthwork specifications) unless specific trench excavation procedures are described in the Plans.

2. Carefully excavate the trench to such depths as required to permit the filter fabric, coarse aggregate and the pipe to be placed in accordance with the details shown on the Plans.

D. Laying Pipe.

1. Lay all pipe conforming with the lines and grades specified in the plans and in accordance with these Specifications. Unless otherwise specified in the Plans or directed by the Engineer, set the pipe with a minimum cover of 30 inches in paved areas (24 inches for non-paved areas) and a maximum cover of 66 inches.

E. Placing Coarse Aggregate and Backfilling.

1. After placing the pipe and without disturbing the pipe, carefully place the coarse aggregate around the pipe to a depth shown in the plans. Fold the filter fabric over the coarse aggregate. Backfill and compact as described below.

a. French Drains Under Pavement: Fill the area above the coarse aggregate with select fill material meeting the requirements of this Section. Place and compact the select fill according to the requirements for pipe as specified in the Earthwork specifications. The Department will allow use of additional coarse aggregate over the top of the pipe instead of select fill material. In this case, the filter fabric shall be extended to wrap the additional coarse aggregate. The top of the coarse aggregate shall not be higher than the bottom of the base, unless shown in the plans. The Department will not pay additional costs associated with substituting coarse aggregate for select fill.

b. French Drains not Under Pavement: Fill and compact the area above the coarse aggregate according to the requirements for pipe in the Earthwork specifications, unless specific procedures are described in the Plans as specified in the Earthwork specifications.

F. Method of Measurement.

1. Quantity of french drains to be paid for under this Article shall be the length in linear feet completed in accordance with Plans and specifications; measured in place and accepted by the Engineer subject to the following conditions:

a. French drain lengths having a depth of trench less than 10 feet below land surface (BLS) will not be accepted for payment by the Engineer.

b. For french drains with specified depth of trench of 15 feet BLS or greater, any length not meeting the specified depth for reasons approved by the Engineer will have the payment quantity calculated as:

1) Quantity for Payment (LF) = Quantity Measured by the Engineer (LF) x Engineer Approved Depth Rounded to the Lowest Whole Foot (ft) / Specified Depth (ft)

G. Basis of Payment.

1. The quantities determined as provided above will be paid for at the Contract unit price for french drains. Such prices and payments will be full compensation for all work, labor, equipment and material necessary for construction of the french drains as specified in these Contract Documents including excavation, sheeting or shoring if required, the disposal of surplus material, providing plastic filter fabric, pipe, coarse aggregate, select backfill, tamping, and final dressing.

2. Price and payment shall also include all clearing and grubbing; and pavement, sidewalk, curb, and gutter restoration unless these items are specifically provided for under separate payment items in this Contract.

3. No separate payment for French Drains is included under this contract.

**514 GEOTEXTILE (REV. 11-04-11)**

A. Description.

1. Install a geotextile (plastic filter) fabric.

B. Material.

1. Meet the plastic filter fabric requirements as specified in FDOT 985.
2. Geotextile used in the Drainage class (type D-3) applications listed in FDOT Design Standards Index 199 shall be woven monofilament geotextiles only. No Slit Film geotextiles are allowed.

C. Construction Methods.

1. General:

- a. Place the fabric in the manner and locations as shown on the construction drawings, in accordance with the manufacturer's directions, and as specified in these Specifications.
- b. Place the fabric on areas with a uniform slope that are reasonably smooth, free from mounds and windrows, and free of any debris or projections which might damage the fabric.
- c. Loosely lay the material. Do not stretch the material.
- d. Replace or repair any fabric damaged or displaced before or during placement of overlying layers to the satisfaction of the Engineer and at no expense to the Department.
- e. When overlapping is necessary, the Contractor may sew the seams to reduce overlaps as specified in FDOT 985-3.
- f. Schedule work so that covering the fabric with the specified material does not exceed the manufacturer's recommendations for exposure to ultraviolet light or five days, whichever is less. If the Engineer determines the exposure time was exceeded, the Contractor shall replace the fabric at no expense to the Department.

2. Subsurface Drainage: When indicated in the plans, place the fabric with the long dimension parallel to the trench. Place the fabric to provide a minimum 12 inch overlap for each joint. Do not drop the filter material from heights greater than 3 feet.

3. Stabilization and Reinforcement: Overlap adjacent strips of fabric a minimum of 2 feet.

4. Riprap Filter:

- a. Overlap adjacent strips of fabric a minimum of 24 inches, and anchor them with securing pins (as recommended by the manufacturer) inserted through both strips of fabric along a line through the midpoint of the overlap and to the extent necessary to prevent displacement of the fabric.
- b. Place the fabric so that the upstream (upper) strip of fabric overlaps the downstream (lower) strip.

- c. Stagger vertical laps a minimum of 5 feet. Use full rolls of fabric whenever possible in order to reduce the number of vertical laps.
- d. Do not drop bedding stone or riprap from heights greater than 3 feet onto the fabric.

D. Method of Measurement.

1. No separate payment for furnishing and placing the geotextile fabric is contained in the Contract Documents.

E. Basis of Payment.

1. All costs for the work specified herein, including furnishing, placing, and sewing or overlapping the fabric is included in the Contract price for the item or items to which the geotextile fabric is incidental.
2. No separate payment will be made for Geotextile.

**519 DRIVEWAY PAVEMENT (REV. 08-23-12)**

A. Description

1. Pursuant to the Contract Documents or as otherwise directed by the Engineer:

- a. Construct new asphalt concrete driveway approaches on public right-of-way.
- b. Restore existing asphalt or cement concrete driveways and approaches that have been authorized to be disturbed by the performance of the Work; and provide all other required labor, material and equipment necessary for complete restoration of the disturbed area.

B. Materials

1. Meet the following requirements:

Limerock	FDOT Section 911
Concrete	FDOT Section 350; Class I (Pavement)
Hot Mix Asphalt (HMA)	Per Article 334 of these Specifications
Joint Seal	FDOT Section 932

C. Preparation and Construction

1. General:

- a. Conform to applicable surface slope requirements of FDOT Index No. 304.
- b. Meet all applicable requirements of the Miami-Dade County Public Works Manual.
- c. Perform any required clearing and grubbing under Article 110 of these Specifications.
- d. Remove or add any additional subgrade material necessary to meet final surface elevation requirements after construction of a new limerock base and pavement of the thicknesses specified below.



- e. Provide a new six inch limerock base; or greater if needed to match existing. Build up in layers not to exceed three inches and compact each layer to obtain a minimum density of 98% of modified Proctor maximum density as determined by FM 1-T 180, Method D.
- f. Maintain the area of excavation in a safe condition and level with the surrounding pavement until work is complete.
- g. Furnish and place all materials; construct all forms, joints, bracing, expansion joint materials, and accessories; apply required surface finishes; and all required clearing and grubbing, excavation and backfilling.
- h. Remove all remaining excess material, dirt, and other debris from the roadways immediately after all construction or restoration of pavement under this Article has been completed.

2. Cement Concrete Pavement:

- a. Concrete pavement for driveways, driveway aprons and sidewalk across driveways must be a minimum thickness of six inches. Materials and construction must conform to the requirements of FDOT Section 350.
- b. Form a 1/2 inch expansion joint between the sidewalk and the driveway or at fixed objects and driveway intersections.
- c. Finish surface of concrete to match existing pavement.

3. Asphalt Concrete Pavement:

- a. Construct a minimum one inch thick HMA pavement layer (Type SP-9.5) meeting the material and construction requirements of Article 334 of these Specifications.

4. Additional Requirements for Restoration of Pavement:

- a. Full-depth saw cut a smooth, straight, neat and square line along the entire width of damaged pavement that is to be restored. Immediately dispose of all excess debris properly.
- b. Restore sidewalks across driveways, cut or damaged by construction, in full sections concrete curb or gutter to the existing height and cross section in full sections or lengths between joints.

D. Method of Measurement

- 1. The quantity to be paid for will be the area, in square yards, of approved driveway pavement constructed or restored in accordance with this Article, as measured and accepted by the Engineer.

E. Basis of Payment

- 1. Price and payment will be full compensation for all work and materials specified in this Article.
- 2. No items for this type of work are anticipated under this contract for this Contract. Any incidental work is to be included under the related work pay item having awarded Contract Prices measured and approved.

**520 CONCRETE GUTTER, CURB ELEMENTS, AND TRAFFIC SEPARATOR (SECTION 520)**

A. Page 583, Article 520-1, Description: Is expanded to include the following:

- 1. The work specified under this section includes any type of curb and /or gutter in accordance with FDOT Design Standards for Design, Construction, Maintenance and Utility Operations on the State Highway System 2008 and the Public Works Manual of Metropolitan Dade County (Standard Road Details R.14.1 and R.14.2) curb with or without gutter, driveway curbs, Type "C" median curb and Type "A" median curb, including the necessary preparation and compaction of the subgrade in both cut and fill areas, as well as backfilling, grading, excavation and final dressing required as directed by the Engineer.

B. Page 583, Article 520-2, Materials: Is amended as follows:

- 1. Class I Concrete shall have a minimum compressive strength of 3,000 p.s.i. at 28 days.

C. Page 591 Article 520-12, Basis of Payment: Is deleted in its entirety and replaced with the following:

- 1. The quantity of curb or curb and gutter, shall be paid for at the Contract unit price for the quantities completed and accepted by the Engineer and does not include ramp and sidewalk curb. Such price and payment shall be full compensation for all work specified under this Section, including the necessary preparation and compaction of the subgrade in both, cut and fill areas, as well as backfilling, grading, excavation and final dressing required as directed by the Engineer.

2. Payment Items: Payment will be made under:

Item No.	Description	Unit
520-2A	Concrete Curb and Gutter (Any Type, Including Base Preparation)	LF

**522 CONCRETE SIDEWALK (SECTION 522)**

A. Page 589, Article 522-1, Description: Is expanded to include the following:

- 1. The work specified under this Section consists of the forming, furnishing, placement, and finishing of concrete for the construction of concrete sidewalks, pedestrian ramps and sidewalk curbs (back of sidewalk) utilizing Class I Concrete. The width, thickness and type shall be as shown and noted in the Plans. All work will be in accordance with this Section except as modified herein.

B. Page 589, Article 522-2, Materials; is amended as follows:

- 1. Class I Concrete shall have a minimum compressive strength of 3,000 p.s.i. at 28 days.

C. Page 591 Article 522-9, Method of Measurement; is expanded to include the following:

1. The quantity to be paid for under this Article shall be the area in square yards of concrete sidewalk and pedestrian ramps, measured in place, complete and accepted. Measurement shall be the final dimensions measured along the surface of the completed work within the neat lines shown on the Plans or designated by the Engineer. No deduction will be made for the area occupied by trees left within the area of sidewalks or for any area occupied by manholes, inlets or other drainage or public utility appurtenances within the sidewalk area.

D. Page 591 Article 522-10, Basis of Payment; is deleted in its entirety and replaced with the following:

1. The quantity, determined as provided above, shall be paid for at the Contract unit price for the quantities completed and accepted by the Engineer. Such price and payment shall be full compensation for all work specified under this Section.
2. When curb and gutter is required for the construction of pedestrian ramps and no specific pay item has been included for the construction of the curb and gutter, such payment shall be included in the pay item for Sidewalk (including pedestrian ramps and sidewalk curbs).
3. No separate payment shall be made for the removal of forms or the filling of excavated area left by removal of forms. Contractor shall be responsible for any vandalized sidewalk until it is finally accepted by the Engineer.
4. Payment will be made at the Contract unit prices for the quantities completed and accepted by the Engineer under the following item(s) as applicable:

Item No.	Description	Unit
522-1-1	Concrete Sidewalk and Driveways (4" Thick) Category 1	SY
522-2-3	Concrete Sidewalk and Driveways (6" Thick) Category 1	SY

## 523 PATTERNED PAVEMENT (REV. 01-06-2015)

### A. Description

1. Install patterned pavement on asphalt or concrete pavement areas at locations and with the color and pattern as specified in the Plans. Use products listed on the FDOT Approved Product List (APL), as approved for use in areas subject to vehicular traffic or non-vehicular traffic, respectively, as specified herein. Install products in accordance with manufacturer's recommendations.
2. For the purpose of this Specification, patterned pavements are defined as a post applied surface marking overlay to either the pavement surface or to an imprinted pavement surface. Vehicular traffic areas are defined as those subject to vehicles within the traveled way, shoulders and auxiliary lanes. Non-vehicular travel areas include medians, islands, curb extensions, sidewalks,

borders, plazas and other areas typically subject to foot traffic only.

3. Install overlay products in areas subject to vehicular traffic to a thickness not exceeding 180 mils. Do not use products requiring removal of pavement or requiring blockouts or trenches below the top of pavement.
4. Variations within a pattern shall comply with ADA requirements.

### B. Materials

#### 1. General:

- a. Use only patterned pavement products approved for use in vehicular and non-vehicular areas, as appropriate, and listed on the APL. Meet manufacturer's specifications for all patterns, textures, templates, sealers, coatings and coloring materials.
- b. Material coatings used to achieve the pattern and color shall produce an adherent, weather resistant, skid resistant, wear resistant surface under service conditions. Color shall be integral and consistent throughout the installation. The composition of materials is intended to be left to the discretion of the manufacturer.
- c. Materials shall be characterized as non-hazardous as defined by Resource Conservation and Recovery Act (RCRA), Subpart C, Table 1 of 40 CFR 261.24 "Toxicity Characteristic". Materials shall not exude fumes which are hazardous, toxic or detrimental to persons or property.

#### 2. Approved Product List (APL):

- a. Manufacturers seeking evaluation of their product shall submit an application to FDOT in accordance with FDOT Section 6 along with the following documentation:
  - 1) Manufacturer's recommendations for applicability of use on concrete or asphalt surfaces.
  - 2) Manufacturer's recommendation for applicability of use in vehicular or non-vehicular travel areas.
  - 3) Manufacturer's specifications and procedures for materials and installation for each use above.
  - 4) For products proposed for use in vehicular traffic areas, independent test data verifying the material meets the requirements of this Section including verification that the product, installed in accordance with the manufacturer's specifications and procedures, has been tested in accordance with either:
    - a) ASTM E-274, Skid Resistance of Paved Surfaces using a standard ribbed full scale tire at a speed of 40 mph (FN40R), and has a minimum FN40R value of 35, or
    - b) ASTM E-1911, Measuring Paved Surface Frictional Properties Using the Dynamic Friction Tester (DFT), at a speed of 40 mph (DFT40), and has a minimum DFT40 value of 40.
  - 5) For products proposed for use in non-vehicular traffic areas, independent test data verifying the

material meets the requirements of this Section including verification that the product, installed in accordance with the manufacturer's specifications and procedures, has been tested in accordance with ASTM E-303 using the British Pendulum Tester and has a British Pendulum Number (BPN) of at least 40.

- 6) For products proposed for use as a bike lane application, independent testing verifying that the material can meet the color as identified in the April 15, 2011, Interim Approval for Optional use of Green Colored Pavement for Bike Lanes, Interim Approval (IA-14) Memorandum Valid Under the 2009 MUTCD ([http://mutcd.fhwa.dot.gov/resources/interim\\_approval/ia14/ia14grnpmbiketlanes.pdf](http://mutcd.fhwa.dot.gov/resources/interim_approval/ia14/ia14grnpmbiketlanes.pdf)).

### 3. Performance Requirements for Products in Vehicular Travel Areas:

- a. In addition to the submittal requirements of B.2 above, APL approval will be contingent on a field service test demonstrating that the patterned pavement product meets the following performance measures at the end of three years from opening to traffic:
  - 1) The average thickness shall be a minimum of 50% of the original thickness.
  - 2) Wearing of the material coating shall not expose more than 15% of the underlying surface area as measured within the traveled way.
  - 3) Friction performance of patterned/textured pavement materials shall meet or exceed one of the following test method values:
    - a) FN40R value of 35 in accordance with ASTM E-274; or,
    - b) DFT40 value of 40 in accordance with ASTM E-1911.
    - c) Manufacturers shall provide a field service test installation of each product within a marked crosswalk on a roadway with an ADT of 6,000 to 12,000 vehicles per day per lane, on a site approved by the Department. The test installation shall be a minimum six feet wide and extend from pavement edge to pavement edge across all traffic lanes and shoulder pavement at the crosswalk location. The test installation shall be tested by the manufacturer in accordance with FM 5-592.

### C. Construction

1. Product Submittals: Prior to installation, submit pattern and color samples to the Engineer for confirmation that the product meets the pattern and color specified in the Plans. Do not begin installation until acceptance by the Engineer.
2. Pavement Cuts: Complete all utility, traffic loop detector, and other items requiring a cut and installation under the finished surface, prior to product installation.
3. Surface Protection: Protect treated surfaces from traffic and environmental effects until the product is completely

installed, including drying and curing according to the manufacturer's instructions.

### 4. Installation Acceptance:

- a. For installation on new asphalt roadways, apply patterned pavement a minimum of 14 days after placement of the adjacent pavement.
- b. Upon completion of the installation, the Engineer will check the area at random locations for geometric accuracy. If any of the chosen areas are found to be deficient, correct the entire patterned area at no additional cost to the Department.
- c. Provide certification that the patterned pavement was installed in accordance with the manufacturer's requirements.

### D. Method of Measurement.

1. The quantity to be paid will be the installed quantities in square yards of patterned pavement, completed and accepted. No deduction will be made for areas occupied by landscaping, manholes, inlets, drainage structures, or by any public utility appurtenances within the area.

### E. Basis of Payment.

1. Price and payment will be full compensation for all work specified in this Article.
2. No separate payment for Patterned Pavement is included under this contract

## 527 DETECTABLE WARNINGS ON WALKING SURFACES (REV. 12-20-16)

### A. Description.

1. Furnish and install Safety Yellow Colored Detectable Warning devices on newly constructed and/or existing concrete or asphalt walking surfaces (curb ramps, sidewalks, shared-use paths, etc.) constructed in accordance with the FDOT Design Standards Index No. 304 and these specifications, where indicated on the Plans or directed by the Engineer.

### B. Materials.

#### 1. General:

- a. Provide Detectable Warnings in accordance with the Americans with Disabilities Act Standards for Transportation Facilities, Section 705.
- b. Provide only embedded Detectable Warning devices, set in wet concrete, for all construction except where retrofit applications of surface applied detectable warnings have been approved in writing by the Engineer.
- c. Use Detectable Warnings consisting of materials intended for exterior use subject to routine pedestrian traffic and occasional vehicular traffic.
- d. Use Detectable Warnings with size and pattern shown in the plans comprised of truncated domes aligned in

parallel rows in accordance with the FDOT Design Standards, Index No. 304. Do not use detectable warnings with a diagonal pattern.

- e. Concrete stamping, field-formed materials, or methods or products used to form Detectable Warnings in wet concrete are not permitted.
2. Material Properties:
- a. Provide Detectable Warnings that meet the following minimum material property requirements when tested in accordance with the indicated Standard appropriate to the material.

PROPERTY	STANDARD	TEST VALUE
Slip Resistance	FM 3-C 1028	Dry Coefficient of Friction – 0.8 min. Wet Coefficient of Friction – 0.65 min. (include recessed areas between truncated domes)
Wear Resistance	FM 5-594	Average Volume Loss: no more than 0.06 cm <sup>3</sup>
Water Absorption*	ASTM D-570	Not to exceed 5%.
Adhesion/Bond Strength**	FM 5-589	150 psi min. tensile adhesion strength
Non-Hazardous Classification	Submit Material Safety Data Sheet (MSDS)	Non-Hazardous, per RCRA Subtitle C
* Applies only to plastic materials.		
** Applies only to surface-applied materials.		

3. Color/Contrast: Use Safety Yellow colored Detectable Warnings on concrete or asphalt walking surfaces. Acceptable Detectable Warnings must maintain a Light Reflectance Value (LRV) CAP Y of 25 – 45, as measured with a spectrophotometer, for a minimum duration of three years.
4. Approved Products List:
- a. Use Detectable Warnings listed on the FDOT Approved Products List (APL) and that have been further evaluated and found acceptable by the Department. At the option of the Contractor, an “or equal” product evaluation request, for an equivalent FDOT APL approved product that meets or exceeds the specification stipulated herein, may be submitted in writing to the Engineer for review and acceptance.
  - b. The following products, subject to continued listing on the FDOT APL, have been evaluated by the Department for use on Department projects:

SURFACE APPLIED DETECTABLE WARNING DEVICES		
Manufacturer	Product	APL Number
Engineered Plastics, Inc.	Armor-Tile Surface Applied Inline Dome	527-000-006
TufTile	TufTile Polymer (Surface Applied)	527-000-045
TufTile	TufTile Polymer (Surface Applied) Radius	527-000-045-RW
EMBEDDED DETECTABLE WARNING DEVICES		
Manufacturer	Product	APL Number
ADA Solutions, Inc.	Cast-In-Place Composite Tactile	527-000-003
ADA Solutions, Inc.	Replaceable Wet Set Composite	527-000-018
Engineered Plastics, Inc.	Armor-Tile Replaceable Cast in Place	527-000-026
Engineered Plastics, Inc.	Armor-Tile Cast-In-Place Inline Dome Tile	527-000-027
Cape Fear Systems, LLC	AlertCast (Replaceable) Cast-In-Place	527-000-029
Access Products, Inc.	Access Tile Replaceable Cast in Place	527-000-033
StrongGo Industries	TekWay Dome Tile	527-000-035
TufTile, Inc.	TufTile Cast Iron (Wet-set) Replaceable	527-000-044
TufTile	TufTile Polymer (Wet Set) Replaceable	527-000-046
TufTile	TufTile Polymer (Wet Set) Radius	527-000-046-RW

A. Installation Procedures.

1. Surface Preparation and Installation: Prepare the surface in accordance with the manufacturer’s recommendations. Use only products and materials appropriate for the surface on which they will be applied. Install in accordance with the manufacturer’s instructions, using materials and equipment recommended and approved by the manufacturer. For surface-applied tiles or mats, use adhesives applied over the entire surface and mechanical fasteners.

B. Method of Measurement.

1. The quantity to be paid for will be the area, in square feet, of Detectable Warnings furnished and installed pursuant

to these specifications, measured in place and accepted by the Engineer.

C. Basis of Payment.

- 1. Price and payment will be full compensation for all work specified in this Article, including all labor, surface preparation, materials and incidentals necessary to complete the work for installation of Detectable Warnings on walking surfaces.
- 2. Payment will be made under:

Item No.	Description	Unit
527-2	Detectable Warning On Walking Surface	SF

b. If mixing and filling sacks at the job site, the mixing and filling requirements of FDOT 530-3.1.1 (Mixing Materials) and FDOT 530-3.1.2 (Filling Sacks) shall also apply.

4. Page 603, Section 530-4.1 – Method of Measurements/Sand-Cement; Delete this Subarticle and substitute the following when using commercially available pre-bagged sand-cement mixes:

a. The pay quantity for the work specified under this Section shall be the number of cubic yards of sand-cement mixture, placed in sacks or used in the grout, actually placed and accepted. For payment purposes, 1 cubic yard of sand-cement riprap shall constitute either 36 (60 lb) bags of sand-cement mixture or 27 (80 lb) bags of sand-cement mixture.

5. No separate payment for Riprap for Drainage is included under this contract

**528 RIPRAP FOR DRAINAGE STRUCTURES**

A. This Article is for sand-cement riprap

- 1. To be used to fill the void space adjacent to proposed inlet structures placed in existing slab-covered trenches, FDOT Section 530 is modified as follows:
- 2. Page 600, Section 530-2.1 – Materials/Sand-Cement; expand this Subarticle to include:
  - a. Sand-Cement riprap to be placed in existing slab-covered trenches may consist of commercially available pre-bagged sand-cement mixes subject to the following:
    - 1) Prior to use, submit the manufacturer’s product specifications and information for the proposed sand-cement product to the Engineer for approval.
    - 2) The sand-cement mix shall consist only of Portland Cement and sand meeting the requirements of FDOT Section 921 and 902-3.3 respectively.
    - 3) Sacks (bags) shall be permeable and absorptive enough to permit passage of water to provide for hydration of the cement.
    - 4) Ensure that sacks are free from holes and strong enough to withstand handling without ripping or splitting.
    - 5) Use only one type and size of pre-bagged sand-cement mix at any one structure.

3. Page 603, Section 530-3.1 – Construction Methods/Sand-Cement; delete this Subarticle and substitute the following:

a. Place sand-cement sacks as shown in the engineering plans or as directed by the Engineer. Sacks are placed without ripping or splitting with its shorter dimension (width) abutting the structure. Lay the sacks in a regular pattern and pack against each other so as to form a close and molded contact after the sand and cement mixture has set up. Remove and replace sacks ripped or torn in placing with sound, unbroken sacks. Then, thoroughly saturate all sacks with water. Grouting, if required by the Engineer, shall be in accordance with FDOT 530-3.1.4.

**536 GUARDRAIL**

A. Description.

- 1. Perform work, pursuant to the Contract Documents and the FDOT Design Standards, to include:
  - a. Construction of metal guardrail on posts of timber or steel
  - b. Removal of existing guardrail
  - c. Construction of guardrail anchorages
  - d. Replacement of guardrail posts

B. Materials.

- 1. Guardrail:
  - a. Construct guardrail of the standard W-beam or thrie beam type. Use materials for the rail and rail elements meeting the steel requirements of FDOT 967-1.
- 2. Posts:
  - a. General:
    - 1) Unless the Contract Documents or Engineer designate a particular type of post, the Contractor may choose the type of material of post to use.
    - 2) Use posts of either timber, or steel, and of the sizes and dimensions specified in the Contract Documents. Use the particular type selected throughout a run of rail, except where special steel posts are required.

b. Timber Posts:

1) Meet the requirements of the latest edition of the Southern Pine Inspection Bureau’s Standard Grading Rules for Southern Pine Lumber, for No.1 grade timber, and treat the posts in accordance with the requirements for posts in FDOT 955-5.3. Ensure that penetration of preservative is in accordance with requirements for round piles and fence posts in FDOT 955-6.2. Shape and drill the posts prior to treatment, and ensure that they do not

vary more than 1 inch from the specified length. Dress all timber posts on all four sides (S4S).

c. Steel Posts:

- 1) Use steel posts meeting the requirements of ASTM A36 steel. Galvanize the posts in accordance with the requirements of ASTM A 123, with 2 oz/ft<sup>2</sup> of zinc coating. Drill the posts prior to galvanizing. Ensure that the manufacturer furnishes certification showing physical and chemical properties of each heat, the amount of spelter coating, and conformance to ASTM A 123.
- 2) The Contractor may use steel guardrail posts of either a rolled section or a welded structural shape with nominal dimensions as shown in the FDOT Design Standards.
- 3) For welded structural shapes, meet the following requirements:
  - a) Ensure that the design properties of the shape meet or exceed the design properties for a W 6 x 9 shape as contained in the AISC Manual of Steel Construction.
  - b) Weld in accordance with the requirements of ASTM A 769.
  - c) After cutting posts to length, place a weld to seal the spaces between the web plate and flange plates.
  - d) Galvanize as specified above after completing all drilling and welding.

3. Anchor Blocks:

- a. Use anchor blocks of Class I concrete, and construct and place them in accordance with the requirements shown in the Plans or as directed by the Engineer.

4. Offset Blocks:

- a. Use guardrail offset blocks of either timber, steel, recycled plastic, or rubber, and of the sizes specified in the FDOT Design Standards.
- b. Treat timber blocks in accordance with the requirements for posts in FDOT 955-5.3. Ensure that penetration of preservative is in accordance with requirements for round piles and fence posts in FDOT 955-6.2. For timber offset blocks, meet the requirements of the latest edition of the Southern Pine Inspection Bureau's Standard Grading Rules for Southern Pine Lumber, for No.1 grade timber. Dress all timber offset blocks on all four sides (S4S). Ensure that timber offset blocks do not vary more than 0.25 inch from the specified length
- c. Use rubber blocks that have a minimum Durometer hardness of 50 (ASTM D 2240), show no cracking at the end of an ozone exposure of 100 ±10 pphm for 15 hours at 100°F (ASTM D 1149 mounting type A), do not exceed 15 points change in Durometer hardness in oven ageing for 70 hours at 158°F (ASTM D 573), and show no cutting or tearing under a 6,500 lb load applied through a guardrail section. Ensure that the blocks present a neat appearance and have plane surfaces. Provide rubber blocks that are 6 inches wide, 8 inches deep and 14 inches high. Allow dimensional tolerances

of ±5/8 inch in height, ±3/8 inch in width, and ±3/8 inch in depth.

- d. For Recycled Plastic offset blocks, meet the requirements of FDOT Section 972.

5. Reflector Elements:

- a. Provide reflectors that meet the requirements of FDOT 993-5.
- b. Mount reflectors onto the guardrail in accordance with the details shown in the Plans and the FDOT Design Standards.

6. Certification:

- a. Provide the Engineer, at least ten days prior to guardrail construction, a certification from the manufacturer confirming that all materials (timber or steel posts, anchor and offset blocks, reflector elements, and all other accessories) meet the requirements of the Contract Documents and the FDOT Design Standards.
- b. Furnish the Engineer a Certificate of Compliance certifying that the guardrail system, materials and construction practices, comply with applicable FDOT Design Standards and Contract Specifications.
- c. Acceptance of furnished material will be based on the Certificate of Compliance, material certification and visual inspection by the Engineer.

C. Setting Posts.

1. Set standard length posts vertically to the depth shown in the FDOT Design Standards. Set special length posts vertically to the depth shown in the plans. Align and realign posts as necessary, until final acceptance. Where the posts are not set in concrete or mounted on structures, backfill the post holes with suitable thoroughly tamped material. As an alternate method, the Contractor may use a post-driving machine, meeting the approval of the Engineer and capable of driving the posts without damaging them.
2. For guardrail post replacement, backfill and compact the existing hole prior to setting the new post.
3. If driving timber posts, the Contractor may either block out holes in the asphalt for the posts during the asphalt paving operation or cut holes through the asphalt mat prior to the post installation. Blocked out holes or cut holes in the asphalt pavement shall be at least 50% larger than the sectional area of the timber post. After completing driving of the posts patch the area of asphalt around each post with fresh hot bituminous mixture.
4. If driving steel posts, drive the post directly through the asphalt mat. Fill depressions or cracks with fresh, hot bituminous mixture in a manner meeting the approval of the Engineer.
5. For either timber or steel post locations, in which rock, concrete or asphalt thicker than 2 inches exist, remove such material and backfill with suitable material, thoroughly tamped as detailed in the FDOT Design Standards.

D. Erection of Rail

1. Erect the guardrail panels, supports, anchors, etc., as shown in the FDOT Design Standards.

E. Existing Guardrail.

1. Stockpile guardrail, so specified, within the right-of-way at a location approved by the Engineer. Dispose of all remaining guardrail not specified for stockpiling.

F. Method of Measurement.

1. Guardrail:

- a. The quantity to be paid for will be the length, in feet, constructed, in place and accepted.
2. Miscellaneous items as provided by the Contract Documents:
    - a. End Anchorage Assemblies:
      - 1) The quantity to be paid for will be the number of each type constructed, in place and accepted.
    - b. Special Guardrail Posts:
      - 1) The quantity to be paid for will be the number of each, constructed, in place and accepted.
      - 2) The designation "Special Guardrail Posts" will include only such posts as require special fabrication, for installation at locations where the normal setting would conflict with concrete structures, such as approach slabs, culvert slabs, footings, inlets, etc. Special posts, however, will not include posts for double-face median guardrail, regardless of whether they are embedded in or attached to concrete.
    - c. Bridge Anchorage Assemblies:
      - 1) The quantity to be paid for will be the number of each, constructed, in place and accepted.
    - d. Guardrail Anchorage (Concrete Barrier Wall):
      - 1) The quantity to be paid for will be the number of each, constructed, in place and accepted.
    - e. Guardrail Post Replacement:
      - 1) The quantity to be paid for will be the number of each, replaced.
    - f. Removal of Existing Guardrail:
      - 1) The quantity to be paid for will be the length, in feet, measured prior to removal.
    - g. Special Steel Guardrail Posts:
      - 1) The quantity to be paid for will be the number of each, constructed, in place and accepted.

G. Basis of Payment.

1. Guardrail:

- a. Price and payment will be full compensation for all work specified under this Article, including the furnishing and installing of the acrylic plastic reflectors and all other

materials as specified. Payment will be made under the items as follows:

- 1) Where the Contractor furnishes all materials for the guardrail, and the Engineer does not require shop-bent rails, payment will be made under the basic item of Guardrail.
  - 2) Where the radius of the guardrail installation is such as to require shop bending of the guardrail panels, payment will be made under the item of Guardrail (Shop-bent Panels).
- b. All component parts of the complete guardrail installation will be included in the price per foot for the above items except, when the Contract Documents provides for the separate payments to be made under the special items listed below.
- 1) End Anchorage Assemblies:
    - a) Price and payment will include all components specified in the Contract Documents and FDOT Design Standards.
  - 2) Special Guardrail Posts:
    - a) Price and payment will include all costs for furnishing and installing the special posts that are over and above the costs for the normal posts, which are replaced by such special posts.
  - 3) Bridge Anchorage Assemblies:
    - a) When the Contract Documents provide for direct payment for Bridge Anchorage Assemblies, price and payment will include furnishing and installing the special End Shoes, Wood Blocks or Retrofit Wing Posts, Concrete Anchor Posts and necessary hardware.
    - b) When the Contract Documents do not provide for direct payment for Bridge Anchorage Assemblies, the Contractor shall include the cost for the assemblies in the Contract price per foot for the guardrail.
  - 4) Guardrail Anchorage (Concrete Barrier Wall):
    - a) Price and payment will include installing connections to concrete barrier walls, as shown on the FDOT Design Standards, Index Nos. 400 and 410.
  - 5) Guardrail Post Replacement:
    - a) Price and payment will include all labor, materials, and equipment required for removal and disposal of existing posts in areas provided by the Contractor, backfilling and compacting existing holes, and replacement with new posts.
  - 6) Removal of Existing Guardrail:
    - a) Price and payment will include all labor and equipment required for removal and disposition of the existing guardrail, as specified in the Contract Documents. No additional payment will be made for the removal of the back rail on double face guardrail, thrie beam guardrail, nested rail, safety pipe rail, rub rail or end anchorages.

7) Special Steel Guardrail Posts with Accessories:

- a) Price and payment will include all components specified in the Contract Documents and the FDOT Design Standards.

2. Payment Items:

- a. No separate payment for Guardrail is included under this contract.

**538 RESETTING GUARDRAIL**

A. Description.

- 1. Remove the existing guardrail, and reset the salvaged guardrail with new materials. Reset the guardrail, at locations shown in the Plans or designated by the Engineer, in accordance with the FDOT design standards for guardrail construction, as modified by the Contract Documents.

B. Materials.

- 1. Prevent damage to reusable materials when removing existing guardrail.
- 2. Furnish all new materials necessary to complete the reset guardrail installation.
- 3. Provide only new offset blocks.
- 4. Meet the requirements specified in the Contract Documents for Guardrail.

C. Construction Methods.

- 1. Set posts in accordance with the requirements of the Contract Documents.
- 2. Erect guardrail panels, anchors, and hardware in accordance with the FDOT design standards for guardrail construction, as modified by the Contract Documents.
- 3. Replace any salvageable materials damaged by operations at no expense to the Department.
- 4. Use a consistent type of post throughout a run of guardrail.

D. Method of Measurement.

- 1. The quantities to be paid for will be as measured and accepted by the Engineer in feet of reset guardrail.
- 2. Additionally and where provided by the Contract Documents, the quantities of the following items to be paid for will be as measured and accepted by the Engineer:
  - a. number of end anchorage assemblies of each type as designated,
  - b. number of special posts, and
  - c. number of bridge anchorage assemblies.

E. Basis of Payment.

- 1. Prices and payments for resetting guardrail will be full compensation for all work specified in this Article, including furnishing all required new hardware and posts, all new offset blocks, and replacement of any material damaged by the Contractor except as specified below.
- 2. Price and payment for end anchorage assemblies, special guardrail posts, and bridge anchorage assemblies will be as specified in the Contract Documents for Guardrail.
- 3. Payment for new guardrail panels furnished to replace such items determined to be non-salvageable, excluding any items damaged by the Contractor, will be paid for at the actual invoiced cost for the panels including transportation charges, to which cost will be added an amount equal to 25% of the total invoice amount.
- 4. No separate payment for Resetting Guardrail is included under this contract.

**550 FENCING TYPE "B" (SECTION 550)**

Page 626, Section 550-6 - Basis of Payment:

- 1. Subarticle 6.1 is expanded to include:
  - The Contract price per linear foot for the Item of Fencing, measured as specified in 550-5.2, shall be full compensation for all work and materials specified in this Section and necessary for the complete installation, including line posts, corner, end, and pull posts and the assemblies therefore, as provided below, and not including the payment stipulated for extra length posts. Such price and payment shall include, but not be limited to, the following specific incidental work:
    - a. Any work required to level and prepare the terrain along the line of the fence.
    - b. Any additional clearing incidental to construction of the fence.
    - c. All preparation for post holes, in whatever type of material, as specified herein, including the Class I Concrete for the placement and setting of all posts.
    - d. Any furnishing and installing of electrical grounds.
    - e. Any additional work or materials required for special construction over irregular terrain, or terrain of inadequate support for the posts, including the additional barbed wire, but not including the extra lengths of posts ordered by the Engineer.
    - f. Any costs of erection and removal of any temporary fencing, which might be necessary for maintaining security of livestock, etc., on adjacent property during construction of the new fence.
- 2. Subarticle 6.2: Delete in its entirety.
- 3. No separate payment for Fencing is included under this contract.



**575 SODDING**

**A. Description**

- 1. Establish a stand of grass within the specified areas, by furnishing and placing sod, and rolling, watering, and maintaining the sodded areas to ensure a healthy stand of grass.

**B. Materials. Meet the following requirements:**

- 1. Sod FDOT 981-2
- 2. Water FDOT Section 983

**C. Construction Methods.**

- 1. Preparation of Ground: Scarify or loosen the areas requiring sod to a depth of 6 inches. On areas where the soil is sufficiently loose, particularly on shoulders and fill slopes, the Engineer may authorize the elimination of the ground preparation. Limit preparation to those areas that can be sodded within 72 hours after preparation. Prior to sodding, thoroughly water areas and allow water to percolate into the soil. Allow surface moisture to dry before sodding to prevent a muddy soil condition.
- 2. Placing Sod: Place sod immediately after ground preparation. Do not use sod which has been cut for more than 72 hours. Stack all sod that is not planted within 24 hours after cutting and maintain proper moist condition.
  - a. Do not sod when weather and soil conditions are unsuitable for proper results. Pre-wet the area prior to placing sod. Do not place sod on eroded or washed out sites.
  - b. Place the sod on the prepared surface, with edges in close contact, and embed it firmly and smoothly by light tamping with appropriate tools.
  - c. Place the sod to the edge of all the paving and shrub areas and 1 inch below adjoining pavement with an even surface and edge. Place rolled sod parallel with the roadway and cut any exposed netting even with the sod edge.
  - d. Roll using a lightweight turf roller. Provide a true and even surface without any displacement of the sod or deformation.
  - e. Where sodding in drainage ditches, stagger the setting of the sod pieces to avoid a continuous seam along the line of flow. Ensure that the offsets of individual strips do not exceed 6 inches. Tamp the outer pieces of sod to produce a featheredge effect.
  - f. Peg sod at locations where the sod may slide. Drive pegs through sod blocks into firm earth, at intervals approved by the Engineer.
  - g. Remove any sod as directed by the Engineer.
- 3. Watering: Thoroughly water the sod immediately after placing. Do not water in excess of 1 inch per week for establishment. The contractor shall water and maintain newly sodded areas as needed and adhere to the following minimum frequencies until final acceptance of the Project by the County unless otherwise approved by the Engineer:

- a. Minimum Watering Schedule (3/4" to 1" per watering)
  - 1) Every day for the first 14 days after placement, followed by
  - 2) Three times per week for next 14 days, followed by
  - 3) Two times per week until final acceptance of the project.

**b. Mowing Schedule**

- 1) Minimum bi-weekly after established, and
- 2) Immediately prior to final acceptance.

**D. Maintenance.**

- 1. Maintain the sodded areas in a satisfactory condition until final acceptance of the project. Include in such maintenance the filling, leveling, and repairing of any washed or eroded areas, as may be necessary. The Department will pay for resodding necessary due to factors determined by the Engineer to be beyond the control of the Contractor.
- 2. Monitor placed sod for growth of pest plants and noxious weeds. If pest plants and/or noxious weeds manifest themselves within 30 days of placement of the sod, treat affected areas by means acceptable to the Department at no expense to the Department. If pest plants and/or noxious weeds manifest themselves after 30 days from date of placement of sod, the Engineer, at his sole option, will determine if treatment is required and whether or not the Contractor will be compensated for such treatment. If compensation is provided, payment approved by the Engineer will be made as unforeseeable work.
- 3. Maintenance of sodded areas is required for no less than thirty (30) days after placement or until the sodded area is determined to be established and satisfactory by the Engineer, whichever is greater.

**E. Method of Measurement.**

- 1. The quantities to be paid for will be the area of sodding measured and accepted by the Engineer.
- 2. Measurement for payment shall include only areas of sodding that have established a satisfactory root system (i.e. leaf blades break before sod can be pulled from the soil by hand).

**F. Basis of Payment.**

- 1. Prices and payments for Sodding will be full compensation for all work, water, and materials required to perform the work as specified in this Article, the satisfactory disposal of excavated material, and the furnishing and application of the water.
- 2. The costs for watering, mowing, and maintaining the sod in a moist condition for a period of at least two weeks, shall be included in the Contract unit price for Sodding.

Item No.	Description	Unit
570-1-2	Performance Turf (Sodding)	SY

## 575 RELOCATION OF TREES OR PALMS; AND PROTECTION OF EXISTING LANDSCAPE

### A. Relocation of trees or palms

#### 1. General

- a. Work consists of relocating trees and/or palms within the existing right of way, within a one (1) mile radius, in locations indicated in the drawings or as directed by the Engineer. Where drainage work is required, minor adjustments to the system may be necessary to minimize relocations.
- b. The Contractor shall be cognizant of and comply with the Miami-Dade County Ordinance regulating the removal and/or relocation of all trees. Permits required for tree removal and/or relocation shall be the responsibility of the Contractor.

#### 2. Material

- a. Water: provide water by a method approved by the Engineer meeting the requirements of FDOT Section 983.
- b. Backfill Material: the existing material excavated from the planting pit is to be used as backfill.

#### 3. Pruning

##### a. Trees

- 1) Prior to root pruning, prune tree canopy to ISA Standards and conform to ANSI A300. The extent of pruning shall be the minimum needed to reduce shock resulting from severing of roots.
- 2) No more than 30 percent of total canopy branches greater than one inch in diameter may be removed. Interior sucker growth and dead wood shall be removed first, followed by selective pruning of branches and limbs. Limbs that run through the tree crown shall be removed before other limbs are removed. Pruning shall not destroy the form of the tree. All cuts shall be made outside of the branch collar.
- 3) Trees shall be root pruned six (6) weeks prior to relocation. No backhoes or trenchers shall be used in the process. Backfill trench within 24 hours after root pruning with coarse sand.
- 4) Where required by the Engineer or the designated County arborist, brace and guy the root pruned tree to support and maintain the tree in a stable vertical position until relocation.

#### 4. Replanting

##### a. Trees

- 1) The planting pit shall be a minimum of 24" wider than the diameter of the rootball unless otherwise directed by the Engineer. The depth of the pit shall be adjusted so that the top of the rootball will be at the same elevation or slightly above the existing ground level. All plants shall be centered in the hole. Trees shall be watered in during the planting process to eliminate air pockets in the backfill.

- 2) Size of the trees will be the trunk diameter measured at breast height (54 inches above grade).

- 3) All trees are to be fertilized at the time of planting with Atlantic Florida East Coast Fertilizer Mixture (No. 5231) 12-06-08 slow-release fertilizer or approved equal. This fertilizer is to be spread evenly over the top of the planting pit after backfilling. The application rate is 2 lbs/tree.

##### b. Palms

- 1) The planting pit shall be a minimum of 24" wider than the diameter of the rootball unless otherwise directed by the Engineer. The depth of the pit shall be adjusted so that the top of the rootball will be at the same elevation or slightly above the existing ground level. All plants shall be centered in the hole. Burlap is to be untied and pulled away from the top of the ball, unless specified in writing by the Engineer. Plants are to be watered-in during the planting process to eliminate all air pockets in the backfill material.

- 2) Size of the palm will be determined by measuring ground level to the topmost portion of the palm.

- 3) All palms are to be fertilized at time of planting with Atlantic Florida East Coast Fertilizer Mixture 08-04-12 slow-release improved palm special fertilizer or equal. This fertilizer is to be spread evenly over the top of the planting pit after backfilling. The application rate of 3 lbs/palm.

#### 5. Mulching:

- a. A planting saucer will be established, the same size as the diameter of the planting pit and the rim shall be no higher than 4 inches. The mulch is to be Forestry Research Products Florimulch (Melaleuca mulch) free of viable seed and burrowing nematodes and certified by the Florida Department of Agriculture, or equal, and is to be spread evenly inside the saucer to a depth of 3 inches.
- b. Remove saucer prior to Project completion or as directed by the Engineer.

#### 6. Staking and Guying:

- a. This work shall be performed in accordance with the standard planting detail for trees and/or palms.
- b. Palms shall be staked using the Arborlock Staking System or equal (with the approval of County representative).
- c. Trees shall be guyed using Arbor Tie (a flat woven polypropylene material with 900 lbs. Break strength) manufactured by Deep Root Partners, L.P., or equal.
- d. Six (6) month after planting, the Contractor shall return to the site and remove all materials used for staking and guying. At the discretion of the Engineer, the period for staking and guying may be extended beyond six (6) months but for no longer than one (1) year.

#### 7. Watering Schedule:

- a. After replanting trees and palms, they are to be watered as follows:
  - 1) for the first 4 weeks 3 times/week

2) for the second 4 weeks 2 times/week

3) for the third 4 weeks 1 time/week

b. Application Rate:

1) Trees and slender trunk palms 6 gal/watering

2) Moderate and heavy trunk palms 10 gal/watering

8. Guarantee of Relocated Trees and Palms

a. All trees and palms that are relocated shall be guaranteed for a period of one year after relocation.

B. Protection of Existing Landscaping

1. Description:

a. Install tree protection barricades when called for in the Contract Documents or by the Engineer to protect existing trees and landscape from damage during project construction. Place barricades, as directed by the Engineer, at the drip line of the landscape foliage or as far from the base of the tree trunk as possible. Barricades shall consist of Heavy-Duty Construction (Orange) Barrier Fence (Minimum 4-feet high) attached to 2-inch by 4-inch by 6-foot long vertical wooden posts per FDOT Index No. 544 except that 2-inch by 4-inch horizontal wooden top bars with a maximum 8-foot spacing between posts shall be used. Barricades shall be able to withstand bumps by heavy equipment and trucks. Maintain barricades in good condition.

b. All trees, shrubbery, and landscaping (on the R/W or adjacent property) irreparably damaged or destroyed by the Contractor during construction, as determined by the Engineer, shall be replaced by and at the Contractor's expense. Trees and shrubbery shall be replaced with like-sized plants; except for trees or shrubs removed pursuant to the requirements of the Contract Documents or at the specific direction of the Engineer. Replacement plant size shall be determined by calculating the total diameter at breast height (DBH) of affected trees, palms, and/or shrubbery, or the total averaged height of affected trees, palms, and/or shrubs. All replacement material must be Florida #1 Grade or better.

C. Method of Measurement:

1. The quantity to be paid for relocation of trees or palms will be the quantities measured, completed and accepted by the Engineer, under the items shown in the Contract Document.

2. The quantity to be paid for protection of existing landscape will be the quantity in linear feet of barricade, completed and accepted, measured by the Engineer.

D. Basis of Payment:

1. Price and payment shall be full compensation for all work specified in this Section inclusive of all labor, material, and equipment necessary for the proper relocation of trees or palms and protection of existing landscape as required by the Contract Documents.

2. No separate payment for Relocation of Trees or Palms and Protection of Existing Landscape is included under this contract.

**580 LANDSCAPE INSTALLATION**

A. Description

1. Refer to Section 580, Landscape Installation for LAP (Off-System), in Appendix "F" of the Special Provisions.

2. Payment will be made under:

Item No.	Description	Unit
580-3	Tree Protection Barricades	LF
580-322-2A	Tree Removal and Disposal (6" to 12" Diameter)	EA

**600 GENERAL PROVISIONS FOR TRAFFIC CONTROL DEVICES (REV. 04-14-15)**

A. Description

1. Refer to Appendices of the Special Provisions for Traffic Signals and Signs Provisions and Specifications.

**701 AUDIBLE AND VIBRATORY PAVEMENT MARKINGS  
(REV. 01-07-2014)**

**A. Description**

1. Apply audible and vibratory pavement markings in accordance with the Contract Documents.

**B. Materials**

1. Thermoplastic:
  - a. Use thermoplastic material meeting the requirements of FDOT 971-1 and 971-9 and listed on the FDOT's Approved Product List (APL) as an approved system. The Engineer will take random samples of the materials in accordance with the FDOT's Sampling, Testing and Reporting Guide schedule.
2. Retroreflective Elements:
  - a. Use reflective elements recommended by the manufacturer that meet the requirements of FDOT 971-1.7 and are part of the system listed on the APL.

**C. Equipment**

1. Use equipment capable of providing continuous, uniform heating of the striping material to temperatures exceeding 390°F, mixing and agitating the material in the reservoir to provide a homogenous mixture without segregation. Use equipment that will maintain the striping material in a plastic state, in all mixing and conveying parts, including the line dispensing device until applied. Use equipment which is capable of producing a consistent pattern of transverse bumps positioned at regular and predetermined intervals. Use equipment which meets the following requirements:
  - a. Capable of traveling at a uniform rate of speed, both uphill and downhill, to produce a uniform application of striping material and capable of following straight lines and making normal curves in a true arc.
  - b. Capable of applying reflective elements to the surface of the completed stripe by automatic dispensers attached to the striping machine such that the reflective elements are dispensed closely behind the installed line. Use reflective element dispensers equipped with an automatic cut-off control that is synchronized with the cut-off of the thermoplastic material and applies the reflective elements uniformly on the entire traffic stripe surface with 50 to 60% embedment.
  - c. Equipped with a special kettle for uniformly heating and melting the striping material. The kettle must be equipped with an automatic temperature control device and material thermometer for positive temperature control and to prevent overheating or scorching of the thermoplastic material.
  - d. Meets the requirements of the National Fire Protection Association (NFPA), State and Local authorities.

**D. Application**

**1. General:**

- a. Before applying traffic stripes and markings, remove any material that would adversely affect the bond of the traffic stripes by a method approved by the Engineer.
- b. Before applying traffic stripes to any portland cement surface, apply a primer, sealer or surface preparation adhesive of the type recommended by the manufacturer. Offset longitudinal lines at least 2 inches from construction joints of portland cement concrete pavement.
- c. Apply traffic stripes or markings only to dry surfaces, and when the ambient air and surface temperature is at least 50°F and rising for asphalt surfaces and 60°F and rising for concrete surface.
- d. Apply striping to the same tolerances in dimensions and in alignment specified in Article 710, Painted Pavement Markings, Subarticle D. When applying traffic stripes and marking over existing markings, ensure that no more than 2 inches on either end and not more than 1 inch on either side of the existing line is visible.
- e. Conduct field tests in accordance with FM 5-541. Take test readings representative of the striping performance. Remove and replace markings not meeting the requirements of this Section.

**E. Thickness:**

1. Apply flat base lines having a thickness of 0.100 to 0.150 inches, exclusive of the audible bumps, when measured above the pavement surface.
2. Measure, record and certify and submit to the Engineer, the thickness of white and yellow pavement markings in accordance with FM 5-541.
3. The Engineer will verify the thickness of the pavement markings in accordance with FM 5-541 within 30 days of receipt of the Contractor's certification.

**F. Dimensions of Audible Bumps:**

1. Apply the raised bumps with a profile such that the leading and trailing edges are sloped at a sufficient angle to create an audible and vibratory warning.
2. Bumps on shoulder and centerline markings shall be at least 0.45 inches at the highest point of the bump, above the pavement surface, including the base line. The height shall be measured after application of drop-on reflective elements. Bumps shall have a minimum baseline coverage dimension of 2.5 inches in both transverse and longitudinal directions. The bumps may have a drainage channel, the width of each drainage channel will not exceed 1/4 inch at the bottom of the channel. The longitudinal distance between bumps shall be approximately 30 inches.

**G. Retroreflectivity:**

1. Apply white and yellow audible and vibratory markings that will attain an initial retroreflectance of not less than 300 mcd/lx-m<sup>2</sup> and not less than 250 mcd/lx-m<sup>2</sup>, respectively. Measure, record, and submit to the

Engineer, the retroreflectivity of white and yellow pavement markings in accordance with FM 5-541.

H. Color:

1. Use pavement marking materials that meet the requirements of FDOT 971-1.

I. Reflective Elements:

1. Apply reflective elements to all markings at the rates determined by the manufacturer's recommendations as identified for the APL System.

J. Loss:

1. If more than 1% of the bumps or more than three consecutive bumps are missing or broken (less than half a bump remaining) within the first 45 days under traffic, replace all failed bumps at no expense to the Department. If more than 2% of the bumps fail within the first 45 days under traffic, the replacement period will extend an additional 45 days from the date all replacement bumps were installed. If, at the end of the additional 45 days, more the 2% of all bumps (initial and replacement) fail, replace all failed bumps at no expense to the Department. Measure, record, certify and submit to the Engineer, the loss of bumps.

K. Contractor's Responsibility for Notification.

1. Notify the Engineer prior to the placement of audible and vibratory markings. Furnish the Engineer with the manufacturer's name and batch numbers of the thermoplastic materials and reflective elements to be used. Ensure that the batch numbers appear on the thermoplastic materials and reflective elements packages.

L. Protection of Newly Applied Audible and Vibratory Markings.

1. Do not allow traffic onto or permit vehicles to cross newly applied pavement markings until they are sufficiently dry. Remove and replace any portion of the pavement markings damaged by passing traffic or from any other cause.

M. Observation Period.

1. Longitudinal pavement markings are subject to a 180 day observation period under normal traffic. The observation period will begin with the satisfactory completion and acceptance of the pavement marking work.
2. The longitudinal pavement markings shall show no signs of failure due to blistering, excessive cracking, chipping, discoloration, poor adhesion to the pavement, loss of reflectivity or vehicular damage. The retroreflectivity shall meet the initial requirements of Subarticle G. The Department reserves the right to check the retroreflectivity any time prior to the end of the observation period.
3. Replace, at no expense to the Department, any longitudinal pavement markings that do not perform

satisfactorily under traffic during the 180 day observation period.

N. Corrections for Deficiencies.

1. Correct all deficiencies by removal and reapplication of a one mile section centered around the deficiency at no cost to the Department.

O. Submittals.

1. Submittal Instructions:

- a. Prepare and submit a certification of quantities to the Engineer. The Department will not pay for any disputed items until the Engineer approves the certification of quantities.

P. Method of Measurement.

1. The quantities to be paid for under this Section will be as follows:
  - a. The length, in net miles, of 6 inches solid traffic stripe, authorized and acceptably applied.
  - b. The total traversed distance in gross miles of 10-30 skip line. The actual applied line is 25% of the traverse distance for a 1:3 ratio. This equates to 1,320 feet of marking per mile of single line.

Q. Basis of Payment.

1. Prices and payments will be full compensation for all work specified in this Section, including, all cleaning and preparing of surfaces, furnishing of all materials, application, curing and protection of all items, protection of traffic, furnishing of all tools, machines and equipment, and all incidentals necessary to complete the work. Final payment will be withheld until all deficiencies are corrected.
2. No separate payment for Audible and Vibratory Pavement Markings is included under this contract.

**705 OBJECT MARKERS AND DELINEATORS (REV. 08-23-12)**

A. Description.

1. Furnish and install object markers to mark obstructions within or adjacent to the roadway of the types and at the locations called for in the Contract Documents.
2. Furnish and install delineators along the side of the roadway to indicate the alignment of the roadway as indicated in the Contract Documents.
3. Meet all requirements of the FDOT Design Standards and the Contract Documents.

B. Materials.

1. General:
  - a. Meet the following requirements:

Object Markers and Delineators	FDOT Section 993
Retroreflective and Nonreflective Sign Sheeting	FDOT Section 994

Specifications, which confirms that each product meets the requirements of this Article.

2. Product Acceptance on the Project:
- a. Ensure that delineators, delineator posts, and markers used to delineate guardrail and barrier wall are listed on the FDOT Qualified Products List.
  - b. Provide to the Engineer a manufacturer's certification conforming to the requirements of Article 1.04 (Controlling Materials) of Division 1, which confirms that each product meets the requirements of this Article.

C. Installation Requirements.

1. Install delineators, object markers, and reflector units for guardrail and barrier wall and in accordance with the MUTCD, FDOT Design Standards and Contract Documents.

D. Method of Measurement.

1. The quantity to be paid for will be the number of delineators or object markers furnished, installed and accepted.

E. Basis of Payment.

1. Prices and payments will be full compensation for work specified in this Article, including the cost of labor, materials, and incidental items required to complete the work.
2. No separate payment for Object Markers and Delineators is included under this contract.

**706 RAISED RETRO-REFLECTIVE PAVEMENT MARKERS AND BITUMINOUS ADHESIVE (REV. 05-02-12)**

A. Description.

1. Place raised Retro-Reflective Pavement Markers (RPMs) and adhesive, which upon installation produces a positive guidance system to supplement other reflective pavement markings.

B. Materials.

1. Use only Class B markers unless otherwise shown on the Plans.
2. Meet the requirements of FDOT Section 970.
3. Product Acceptance on the Project.
  - a. Use only reflective pavement markers and bituminous adhesive that are listed on the FDOT Qualified Products List.
  - b. Provide Engineer a producer's certification, conforming to the requirements of Article 1.04 (Controlling Materials) of the General Requirements to these

C. Equipment.

1. Use equipment having either thermostatically controlled double boiler type units utilizing heat transfer oil or thermostatically controlled electric heating pots to install hot applied bituminous adhesive. Do not use direct flame melting units with flexible adhesives; however, this type of unit may be used with standard adhesive in accordance with manufacturer's recommendations. Use a melter/applicator unit suited for both melting and pumping the adhesive through heated applicator hoses.
2. Heat the adhesive to between 375 and 425°F and apply directly to the bonding surface from the melter/applicator by either pumping or pouring. Maintain the application temperature between 375 and 425°F. The adhesive may be reheated. Do not exceed the manufacturer's recommendations for pot life at application temperatures.

D. Application.

1. Apply RPMs to the bonding surface using bituminous adhesives only. Engineer will conduct field testing in accordance with Florida Method (FM) 5-566. Correct RPMs not applied in accordance with these requirements at no cost to the Department.
2. Prior to application of adhesive, clean the bonding surface to remove any material that would adversely affect the adhesive.
3. Apply the adhesive to the bonding surface, not the RPMs, so that 100% of the bonding area of the RPMs will be covered, in accordance with adhesive manufacturer's recommendations. Apply sufficient adhesive to ensure, that when the RPMs are pressed downward into the adhesive, adhesive will be forced out around the entire perimeter of each RPM.
4. Immediately remove excess adhesive from the bonding surface and exposed surfaces of the RPMs. Soft rags moistened with mineral spirits meeting Federal Specifications TT-T-291 or kerosene may be used to remove adhesive from exposed faces of the RPMs. Do not use any other solvent. If any adhesive, pavement marking materials or other foreign matter adheres to the reflective face of the RPM, replace the RPM at no cost to the Department.
5. Install RPMs with the reflective face of the RPM perpendicular to a line parallel to the roadway centerline. Do not install RPMs over longitudinal or transverse joints of the bonding surface.
6. Ensure that all final RPMs are in place prior to opening the road to traffic.
7. If more than 2 percent of the RPMs fail in adhesion or alignment within the first 45 days under traffic, replace all failed RPMs at no expense to the Department. If more than 5 percent of the RPMs fail in adhesion and or alignment during the initial 45 day period, Engineer will extend the replacement period an additional 45 days from the date that all replacement RPMs have been installed. If, at the end of the additional 45 day period, more than 2

percent of all RPMs (initial installation and 45 day replacements combined) fail in adhesion or alignment, replace all failed RPMs at no expense to the Department.

E. Contractor's Responsibility for Notification.

1. Notify Engineer prior to the placement of RPMs. At the time of notification, indicate the manufacturer and the LOT numbers of RPMs and bituminous adhesive that are intended for use. Verify that the approved LOT numbers appear on the material packages. Furnish a test report to Engineer certifying that the materials meet all requirements specified.

F. Method of Measurement.

1. Unless otherwise specified herein, the quantities to be paid for will be the number of RPMs, furnished and installed, completed and accepted.

G. Basis of Payment.

1. Lump Sum Payment: When the pay item for Painted Pavement Markings (Final Surface) is included in the Contract, price and payment for RPMs is as stipulated in Article 710 of these Specifications. RPMs will not be measured or paid for separately.
2. Payment will be made under the item(s) below if provided in the Contract with awarded Contract unit price(s) for the completed quantities, measured and accepted by Engineer. Price and payment will be full compensation for all work specified in this Article.

Item	Description	Unit
706- 1-12	Reflective Pavement Marker (class B, mono or bi-directional, all colors)	EA

**710 PAINTED PAVEMENT MARKINGS (REV. 05-02-12)**

A. Description.

1. Apply Painted Traffic Stripes and Raised Retro-Reflective Pavement Markers (RPMs), in accordance with the Contract Documents.

B. Materials.

1. Use only materials listed on the FDOT Qualified Products List (QPL) meeting the following requirements:

Raised Retro-reflective Pavement Markers and Bituminous Adhesive	FDOT Section 970
Standard Waterborne Fast Dry Traffic Paint	FDOT 971-1 and 971-3
Fast Dry Solvent Paint	FDOT 971-1 and 971-4
Glass Spheres	FDOT 971-1 and 971-2

C. Equipment.

1. Use equipment that will produce continuous uniform dimensions of pavement markings of varying widths and meet the following requirements:
  - a. Capable of traveling at a uniform, predetermined rate of speed, both uphill and downhill, in order to produce a uniform application of paint and capable of following straight lines and making normal curves in a true arc.
  - b. Capable of applying glass spheres to the surface of the completed stripe by an automatic sphere dispenser attached to the striping machine such that the glass spheres are dispensed closely behind the installed line. Use a glass spheres dispenser equipped with an automatic cut-off control that is synchronized with the cut-off of the traffic paint and applies the glass spheres in a manner such that the spheres appear uniform on the entire pavement markings surface with 50 to 60 percent embedment.
  - c. Capable of spraying the paint to the required thickness and width without thinning of the paint.
2. Paint tank must be equipped with nozzles having cut-off valves, which will apply broken or skip lines automatically.

D. Application:

1. General:

- a. Remove, by a method approved by Engineer, existing pavement markings such that scars or traces of removed markings will not conflict with new stripes and markings. Clean and dispose at an approved site all resulting debris. Use of paint to cover conflicting pavement markings is prohibited. Cost for removal of pavement markings is incidental to the work specified in this Article and will not be measured separately for payment. Cost for removing conflicting pavement markings during maintenance of traffic operations is included in general costs for Maintenance of Traffic.
- b. Before applying traffic stripes and markings, remove any material that would adversely affect the bond of the traffic stripes by a method approved by Engineer and consistent with manufacturer's specifications.
- c. Remove any vegetation, soil, and other materials covering the pavement where the marking is to be applied.
- d. Apply traffic stripes and markings only to dry surfaces, and when the ambient air and surface temperature is at least 40°F and rising. Do not apply traffic stripes and markings when winds are sufficient to cause spray dust.
- e. Apply traffic stripes and markings, having well defined edges, over existing pavement markings such that not more than 2 inches on either end and not more than 1 inch on either side is visible.
- f. Mix the paint thoroughly prior to pouring into the painting machine. Apply paint to the pavement by spray or other means approved by Engineer.
- g. Conduct field testing in accordance with Florida Method (FM) 5-541. Remove and replace traffic stripes and markings not meeting the requirements of this Article at no additional cost to the Department.



- h. Apply all pavement markings prior to opening the road to traffic.
  - i. Apply all retro-reflective pavement markers per the requirements of Article 706 (Raised Retro-Reflective Pavement Markers and Bituminous Adhesive).
2. Painted Pavement Markings (Final Surface), when included as a single lumps sum item in the Contract having and awarded Contract price, will include two applications of standard painted pavement markings and one application of retro-reflective pavement markers applied to the final surface. Wait at least 14 days after the first application to apply the second application of Painted Pavement Markings (Final Surface). Second application must be applied prior to final acceptance of the project.
  3. Thickness: Apply paint to attain a minimum wet film thickness in accordance with the manufacturer's recommendations.
  4. Retroreflectivity:
    - a. Apply white and yellow standard pavement markings that will attain an initial retroreflectance of not less than 300 mcd/lx·m<sup>2</sup> and not less than 250 mcd/lx·m<sup>2</sup>, respectively. Measure, record and certify on a Department approved form and submit to Engineer, the retroreflectivity of white and yellow pavement markings in accordance with FM 5-541.
    - b. The Department reserves the right to test the markings within 3 days of receipt of the Contractor's certification. Failure to afford the Department opportunity to test the markings will result in non-payment. The test readings should be representative of the Contractor's striping performance. If the retroreflectivity values measure below values shown above, reapply the pavement markings at no additional cost to the Department.
    - c. For standard pavement markings, ensure that the minimum retroreflectance of white and yellow pavement markings are not less than 150 mcd/lx m<sup>2</sup>. If the retroreflectivity values fall below the 150 mcd/lx m<sup>2</sup> value within six months of initial application, the striping will be reapplied at the Contractor's expense.
  5. Color: Use paint material that meets the requirements of FDOT 971-1.
  6. Glass Spheres: Apply glass spheres on all pavement markings immediately and uniformly following the paint application. The rate of application shall be based on the manufacturer's recommendation.
- E. Tolerances in Dimensions and in Alignment.
1. Establish tack points at appropriate intervals for use in aligning stripes, and set a stringline from such points to achieve accuracy.
  2. Dimensions:
    - a. Longitudinal Lines: Apply painted skip line segments with no more than ±12 inches variance, so that over-tolerance and under-tolerance lengths between skip line and the gap will approximately balance. Apply longitudinal lines at least 2 inches from construction joints of Portland cement concrete pavement.
    - b. Transverse Markings, Gore Markings, Arrows, and Messages: Apply paint in multiple passes when the marking cannot be completed in one pass, with an overall line width allowable tolerance of ±1 inch
    - c. Contrast Lines: Use black paint to provide contrast on concrete or light asphalt pavement, when specified by Engineer. Apply black paint in 10 foot segments following each longitudinal skip line.
3. Alignment:
- a. Apply painted stripes that will not deviate more than 1 inch from the stringline on tangents and curves one degree or less.
  - b. Apply painted stripes that will not deviate more than 2 inches from the stringline on curves greater than one degree.
  - c. Apply painted edge stripes uniformly, not less than 2 inches or more than 4 inches from the edge of pavement, without noticeable breaks or deviations in alignment or width.
  - d. Remove and replace at no additional cost to the Department, traffic stripes that deviate more than the above stated requirements.
4. Correction Rates: Make corrections of variations in width at a maximum rate of 10 feet for each 0.5 inches of correction. Make corrections of variations in alignment at a maximum rate of 25 feet for each 1 inch of correction, to return to the stringline.
- F. Contractor's Responsibility for Notification.
1. Notify Engineer prior to the placement of the materials. Furnish Engineer with the manufacturer's name and batch numbers of the materials and glass spheres to be used. Ensure that the approved batch numbers appear on the materials and glass spheres packages.
- G. Protection of Newly Painted Pavement Markings.
1. Do not allow traffic onto or permit vehicles to cross newly applied pavement markings until they are sufficiently dry.
  2. Remove and replace any portion of the pavement markings damaged by passing traffic or from any other cause, at no additional cost to the Department.
- H. Corrections for Deficiencies to Applied Painted Pavement Markings.
1. Reapply a 1.0 mile section centered around any deficiency, at no additional cost to the Department.
- I. Submittals.
1. Submittal Instructions: Prepare a certification of quantities, using the Department's current approved form, for each project in the Contract. Submit the certification of quantities and daily worksheets to Engineer. The Department will not pay for any disputed items until Engineer approves the certification of quantities.
  2. Contractor's Certification of Quantities: Request payment by providing to Engineer a monthly certification of

quantities with each payment requisition or as directed by Engineer, based on the amount of work done or completed. Ensure the certification of quantities include the following:

- a. Contract Number, Certification Number, Certification Date and the period that the certification represents.
  - b. The basis for arriving at the amount of the progress certification, less payments previously made and less any amount previously retained or withheld. The basis will include a detailed breakdown provided on the certification of items of payment.
- J. Method of Measurement.

1. The quantities to be paid for under this Article will be as follows:

- a. Length, in net miles, of 6 inch Solid Traffic Stripe, authorized and acceptably applied.
  - b. Total traversed distance in gross miles of 10-30 or 3-9 skip line. The actual applied line is 25 percent of the traverse distance for a 1:3 ratio. This equates to 1,320 feet of marking per mile of single line.
  - c. Net length, in feet, of each of all other types of lines and stripes, authorized and acceptably applied.
  - d. Number of pavement messages, symbols and directional arrows, authorized and acceptably applied. For bicycle marking, the bicycle symbol and the arrow will be paid as one unit.
  - e. Lump Sum, as specified under Final Surface above, when the item for Painted Pavement Markings (Final Surface) is provided in the Contract with an awarded Contract Unit Price.
2. The net length, in feet of dotted and skip stripes other than 10-30 and 3-9 will be measured as the distance from the beginning of the first painted stripe to the end of the last painted stripe with proper deductions made for unpainted intervals as determined by plan dimensions or stations, subject to the requirements of Subarticle 1.07 F.3 (Determination of Pay Areas) of the General Requirements to these Specifications. Unpainted intervals will not be included in pay quantity.
3. The gross-mile measurement of 10-30 and 3-9 Skip Traffic Stripes will be taken as the distance from the beginning of the first painted stripe to the end of the last painted stripe, and will include the unpainted intervals. It will not include any lengths of unpainted intervals which, by design or by other intent of the Department, are greater than 30 feet. Final measurement will be determined by plan dimensions or stations, subject to the requirements of Subarticle 1.07 F.3 of the General Requirements to these Specifications.

K. Basis of Payment.

1. General:
  - a. Prices and payments will be full compensation for all work specified in this Article, including all cleaning and preparing of surfaces, furnishing of all materials, application, curing and protection of all items, protection of traffic, furnishing of all tools, machines and

equipment, and all incidentals necessary to complete the work.

- b. Final payment will be withheld until all deficiencies are corrected.
2. Lump Sum Payment: When the item for Painted Pavement Markings (Final Surface) is included in the proposal, prices and payments will be full compensation for two applications of all painted pavement markings applied to the final surface, and one application of retro-reflective pavement markers applied to the final surface in accordance Article 706 of these Specifications.
  3. Payment, for the completed quantities measured and accepted by Engineer, will be made under the item(s) below if provided in the Contract with awarded Contract unit price(s).
  4. No separate payment for Painted Pavement Markings is included under this contract.

## **711 THERMOPLASTIC TRAFFIC STRIPES AND MARKINGS (REV. 05-02-12)**

A. Description.

1. Apply new thermoplastic traffic stripes and markings, or refurbish existing thermoplastic traffic stripes and markings, in accordance with the Contract Documents.

B. Materials.

1. Thermoplastic: Use only thermoplastic materials listed on the FDOT Qualified Products List (QPL). Engineer may require random samples of all material. Use materials meeting the following requirements:

Initial or Recapped Stripes and Markings: FDOT 971-1 and 971-5

Refurbishing Existing Stripes and Markings: FDOT 971-1 and 971-5

Preformed Stripes and Markings: FDOT 971-1 and 971-6

2. Glass Spheres: Use only glass spheres listed on the FDOT QPL, meeting the requirements of FDOT 971-1 and 971-2. Engineer may require random samples of all glass spheres in accordance with ASTM D 1214.

3. Sand: Use materials meeting the requirements of FDOT 971-5.4.

C. Equipment.

1. Use equipment capable of providing continuous uniform heating of striping materials to temperatures exceeding 390°F, mixing and agitation of the material reservoir to provide a homogeneous mixture without segregation. Use equipment that will maintain the striping material in a plastic state, in all mixing and conveying parts, including the line dispensing device until applied.
2. Use equipment which can produce varying width traffic stripes and which meets the following requirements:

- a. Capable of traveling at a uniform, predetermined rate of speed, both uphill and downhill, in order to produce a uniform application of striping material and capable of following straight lines and making normal curves in a true arc.
- b. Capable of applying glass spheres to the surface of the completed stripe by a double drop application for initial traffic striping and marking and a single drop application for recapping and refurbishing. The bead dispenser for the first bead drop shall be attached to the striping machine in such a manner that the beads are dispensed closely behind with the thermoplastic material. The second bead dispenser bead shall be attached to the striping machine in such a manner that the beads are dispensed immediately after the first bead drop application. Glass spheres dispensers shall be equipped with an automatic cut-off control that is synchronized with the cut-off of the thermoplastic material and applies the glass spheres in a manner such that the spheres appear uniform on the entire traffic stripes and markings surface with, 50 to 60 percent embedment.
- c. Equipped with a special kettle for uniformly heating and melting the striping material. The kettle must be equipped with an automatic temperature control device and material thermometer for positive temperature control and to prevent overheating or scorching of the thermoplastic material.
- d. Meet the requirements of the National Fire Protection Association, state, and local authorities.

D. Application.

1. General:

- a. Remove, by a method approved by Engineer, existing pavement markings such that scars or traces of removed markings will not conflict with new stripes and markings. Clean and dispose at an approved site all resulting debris. Use of paint to cover conflicting pavement markings is prohibited. Cost for removal of pavement markings is incidental to the work specified in this Article. Cost for removing conflicting pavement markings during maintenance of traffic operations to be included in Maintenance of Traffic.
- b. Remove any vegetation, soil, and other materials covering the pavement where the marking is to be applied.
- c. Before applying traffic stripes and markings remove, by a method approved by Engineer and consistent with manufacturer's specifications, any material that would adversely affect the bond of the traffic stripes. Before applying traffic stripes to any Portland cement concrete surface, apply a primer, sealer or surface preparation adhesive of the type recommended by the manufacturer. Offset longitudinal lines at least 2 inches from any longitudinal joints of Portland cement concrete pavement.
- d. Apply traffic stripes or markings only to dry surfaces, and when the ambient air and surface temperature is at least 50°F and rising for asphalt surfaces and 60°F and rising for concrete surfaces.
- e. Apply striping to the same tolerances in dimensions and in alignment specified under "Tolerances in Dimension

and in Alignment" below. When applying traffic stripes and markings over existing markings, ensure that not more than 2 inches on either end and not more than 1 inch on either side of the existing line is visible.

- f. Apply thermoplastic material to the pavement either by spray, extrusion or other means approved by Engineer.
  - g. Conduct field tests in accordance with Florida Method (FM) 5-541. Take test readings representative of the striping performance. Remove and replace traffic stripes and markings not meeting the requirements of this Article at no additional cost to the Department.
  - h. Apply all final pavement markings prior to opening the road to traffic.
  - i. Preformed Thermoplastic: Apply markings only to dry surfaces and when ambient air temperature is at least 32°F. Prior to installation, follow the manufacturer's recommendations for pre-heating.
2. Thickness:
- a. Initial or Recapped Stripes and Markings:
    - 1) Apply or recap traffic stripes or markings such that all lane lines, center lines, transverse markings and traffic stripes and markings within traffic wearing areas, will have a thickness of 0.10 to 0.15 inch when measured above the pavement surface.
    - 2) Gore, island, and diagonal stripe markings, bike lane symbols and messages, wherever located, will have a thickness of 0.09 to 0.12 inch when measured above the pavement surface.
    - 3) Measure, record, certify and submit to Engineer, the thickness of white and yellow pavement markings in accordance with FM 5-541.
  - b. Refurbishing Existing Traffic Stripes and Markings: Apply a minimum of 0.06 inch of thermoplastic material. Ensure that the combination of the existing stripe and the overlay after application of glass spheres does not exceed the maximum thickness of 0.150 inch for all lines.
3. Retroreflectivity:
- a. Apply white and yellow traffic stripes and markings that will attain an initial retroreflectivity of not less than 450 mcd/lx·m<sup>2</sup> and not less than 350 mcd/lx·m<sup>2</sup>, respectively for all longitudinal lines.
  - b. All transverse lines, messages and arrows will attain an initial retroreflectivity of not less than 300 mcd/lx·m<sup>2</sup> and 250 mcd/lx·m<sup>2</sup> for white and yellow respectively.
  - c. All pedestrian crosswalks, bike lane symbols or messages in a proposed bike lane shall attain an initial retroreflectivity of not less than 275 mcd/lx·m<sup>2</sup>.
  - d. Measure, record, certify, and submit to Engineer, the retroreflectivity of white and yellow pavement markings in accordance with FM 5-541.
4. Glass Spheres:
- a. Longitudinal Lines:
    - 1) For initial traffic striping and marking, apply the first drop of Type 4 or larger glass spheres immediately followed by the second drop of Type 1 glass spheres.

- 2) For refurbishing, apply a single drop of Type 3 glass spheres.
  - 3) Apply reflective glass spheres to all markings at the rates determined by the manufacturer's recommendations.
- b. Transverse Stripes and Markings:
- 1) Apply a single drop of Type 1 glass spheres.
  - 2) Apply reflective glass spheres to all markings at the rates determined by the manufacturer's recommendations.
  - 3) Apply a mixture consisting of 50 percent glass spheres and 50 percent sharp silica sand to all thermoplastic pedestrian crosswalk lines and bike lane symbols at the rates determined by the manufacturer's recommendations.
- c. Preformed Markings: These markings are factory supplied with glass spheres and skid resistant material. No additional glass spheres or skid resistant material should be applied during installation.
- E. Tolerances in Dimensions and in Alignment.
- 1. Establish tack points at appropriate intervals for use in aligning stripes, and set a stringline from such points to achieve accuracy.
  - 2. Dimensions:
    - a. Longitudinal Lines: Apply thermoplastic skip line segments with no more than  $\pm 12$  inches variance, so that over-tolerance and under-tolerance lengths between skip line and the gap will approximately balance. Apply longitudinal lines at least 2 inches from construction joints of Portland cement concrete pavement.
    - b. Transverse Markings, Gore Markings, Arrows, and Messages: Apply thermoplastic in multiple passes when the marking cannot be completed in one pass, with an overall line width allowable tolerance of  $\pm 1$  inch
    - c. Contrast Lines: Use black paint to provide contrast on concrete or light asphalt pavement, when specified by Engineer. Apply black paint in 10 foot segments following each longitudinal skip line.
  - 3. Alignment:
    - a. Apply thermoplastic stripes that will not deviate more than 1 inch from the stringline on tangents and curves one degree or less.
    - b. Apply thermoplastic stripes that will not deviate more than 2 inches from the stringline on curves greater than one degree.
    - c. Apply thermoplastic edge stripes uniformly, not less than 2 inches or more than 4 inches from the edge of pavement, without noticeable breaks or deviations in alignment or width.
    - d. Remove and replace at no additional cost to the Department, traffic stripes that deviate more than the above stated requirements.
  - 4. Correction Rates:
    - a. Make corrections of variations in width at a maximum rate of 10 feet for each 0.5 inches of correction. Make corrections of variations in alignment at a maximum rate of 25 feet for each 1 inch of correction, to return to the stringline.
- F. Contractor's Responsibility for Notification.
- 1. Notify Engineer prior to the placement of the thermoplastic materials.
  - 2. Furnish Engineer with the manufacturer's name and batch numbers of the thermoplastic materials and glass spheres to be used.
  - 3. Ensure that the approved batch numbers appear on the thermoplastic materials and glass spheres packages.
- G. Protection of Newly Applied Traffic Stripes and Markings.
- 1. Do not allow traffic onto or permit vehicles to cross newly applied pavement markings until they are sufficiently dry.
  - 2. Remove and replace any portion of the pavement markings damaged by passing traffic or from any other cause, at no additional cost to the Department.
- H. Observation Period.
- 1. Pavement markings are subject to a 180 day observation period under normal traffic. The observation period shall begin with the satisfactory completion and acceptance of the work.
  - 2. The pavement markings shall show no signs of failure due to blistering, excessive cracking, chipping, discoloration, poor adhesion to the pavement, loss of reflectivity or vehicular damage. The retroreflectivity must meet the initial requirements stipulated above. The Department reserves the right to check the color and retroreflectivity any time prior to the end of the observation period.
  - 3. Replace, at no additional expense to the Department, any pavement markings that do not perform satisfactorily under traffic during the 180 day observation period.
- I. Corrections for Deficiencies.
- 1. Recapping applies to conditions where additional striping material is applied to new or refurbished traffic stripes or markings to correct a deficiency. Recap a 1.0 mile section centered around the deficiency with additional striping material or by complete removal and reapplication at no additional cost to the Department.
  - 2. If recapping will result in a thickness exceeding the maximum allowed, the traffic stripes or markings must be removed and reapplied.
- J. Submittals.
- 1. Submittal Instructions: Prepare a certification of quantities, for each project in the Contract. Submit the certification of quantities and daily worksheets to Engineer. The Department will not pay for any disputed items until Engineer approves the certification of quantities.

2. Contractor's Certification of Quantities: Request payment by submitting a certification of quantities with each payment requisition, based on the amount of work done or completed. Ensure the certification of quantities includes the following:
  - a. Contract Number, Certification Number, Certification Date and the period that the certification represents.
  - b. The basis for arriving at the amount of the progress certification, less payments previously made and less any amount previously retained or withheld. The basis will include a detailed breakdown provided on the certification of items of payment.

K. Method of Measurement.

1. Quantities to be measured by Engineer for payment under this Article will be as follows:
  - a. The length, in net miles, of 6 inch Solid Traffic Stripe, authorized and acceptably applied.
  - b. The total traversed distance in gross miles of 10-30 or 3-9 skip line. The actual applied line is 25 percent of the traverse distance, for a 1:3 ratio. This equates to 1,320 feet of marking per mile of single line.
  - c. The net length, in feet, of all other types of lines and stripes, authorized and acceptably applied.
  - d. The area, in square feet, of Removal of Existing Pavement Markings, acceptably removed. Cost for removing conflicting pavement markings during maintenance of traffic operations is included in Maintenance of Traffic.
  - e. The number of pavement messages, symbols and directional arrows, authorized and acceptably applied.

L. Basis of Payment.

1. Prices and payments will be full compensation for all work specified in this Article, including all cleaning and preparing of surfaces, furnishing of all materials, application, curing and protection of all items, protection of traffic, furnishing of all tools, machines and equipment, and all incidentals necessary to complete the work. Final payment will be withheld until all deficiencies are corrected.
2. Payment, for the completed quantities measured and accepted by Engineer, will be made under the item(s) below if provided in the Contract with awarded Contract unit price(s).

Item	Description	Unit
711-11-121	Thermoplastic (White) Solid 6"	LF
711-11-123	Thermoplastic (White) Solid 12"	LF
711-11-125	Thermoplastic (White) Solid 24"	LF
711-11-221	Thermoplastic (Yellow) Solid 6"	LF
711-7	Remove Existing Pavement Markings	SF

## **SECTION 7: SPECIAL PROVISIONS**

## SPECIAL PROVISIONS

# SPECIAL PROVISIONS

## TABLE OF CONTENTS

### 1. PROJECT INFORMATION

---

1.01	SPECIAL PROVISIONS .....	1
1.02	SCOPE OF WORK .....	1
1.03	LOCATION OF WORK .....	1
1.04	TIME FOR COMPLETION .....	2
1.05	PLANS .....	2

### 2. SPECIAL CONSTRUCTION REQUIREMENTS

---

2.01	FIELD OFFICE .....	3
2.02	SCHOOL ZONE SPEED LIMIT BEACON ASSEMBLY .....	3
2.03	TRAFFIC SIGNALIZATION AND SIGNS .....	4

APPENDIX "A" TO SPECIAL PROVISIONS  
 Authorization Agreement for Automatic Deposit

APPENDIX "B" TO SPECIAL PROVISIONS  
 Section 600: General Provisions for Traffic Control  
 Devices

APPENDIX "C" TO SPECIAL PROVISIONS  
 Section 120: Earthwork and Related  
 Operations for LAP (Off-System)

APPENDIX "D" TO SPECIAL PROVISIONS  
 Section 334: Superpave Asphalt for LAP (Off-System)

APPENDIX "E" TO SPECIAL PROVISIONS  
 Section 344: Concrete for LAP (Off-System)

APPENDIX "F" TO SPECIAL PROVISIONS  
 Section 580: Landscape Installation for LAP (Off-System)

APPENDIX "G" TO SPECIAL PROVISIONS  
 Section 630: Conduit

APPENDIX "H" TO SPECIAL PROVISIONS  
 Section 635: Pull, Splice, and Junction Boxes

APPENDIX "I" TO SPECIAL PROVISIONS  
 Section 639: Electrical Power Service Assembly

APPENDIX "J" TO SPECIAL PROVISIONS  
 Section 641: Prestressed Concrete Poles

APPENDIX "K" TO SPECIAL PROVISIONS  
 Section 654: Rectangular Rapid Flashing  
 Beacons

APPENDIX "L" TO SPECIAL PROVISIONS  
 Section 660: Vehicle Detection System

APPENDIX "M" TO SPECIAL PROVISIONS  
 Section 671: Traffic Signal Controllers

APPENDIX "N" TO SPECIAL PROVISIONS  
 Section 682: Traffic Management CCTV Cameras



APPENDIX "O" TO SPECIAL PROVISIONS  
Internally Illuminated Street Name Signs

APPENDIX "P" TO SPECIAL PROVISIONS  
LED Pedestrian Countdown Module (16" X 18")

APPENDIX "Q" TO SPECIAL PROVISIONS  
School Zone Speed Limit Beacon Assembly

APPENDIX "R" TO SPECIAL PROVISIONS  
Loop Assembly Inductance and Resistance Test

APPENDIX "S" TO SPECIAL PROVISIONS  
Section 700: Roadway Signs

APPENDIX "T" TO SPECIAL PROVISIONS  
ROW Certification Form# 575-095-35

APPENDIX "U" TO SPECIAL PROVISIONS  
Railroad Clear Letter

APPENDIX "V" TO SPECIAL PROVISIONS  
Utilities Clear Letter

APPENDIX "W" TO SPECIAL PROVISIONS  
No Permits Clear Letter

## 1. PROJECT INFORMATION

---

### 1.01 SPECIAL PROVISIONS

- A. These Special Provisions amend or supplement the Miscellaneous Construction Contract (MCC) CICC 7360-0/08, the MCC 7360 Plan, and other provisions of the Contract Documents as indicated below. All provisions that are not so amended or supplemented remain in full force and effect. All requirements of the Contract Documents, or portions thereof, which are not specifically modified, deleted, or superseded hereby, remain in full effect.

### 1.02 SCOPE OF WORK

- A. Work under this contract shall include, but is not limited to the following: Furnishing all supervision, labor, required materials, equipment, tools and performing all operations necessary to add/upgrade: pedestrian indication heads and push buttons at signalized intersections, school speed zone signs and flashing beacons, school crosswalk signs, pavement markings, sidewalks, and pedestrian ramps. All work to be performed in accordance with the construction plans and specifications contained herein.
- B. The purpose of this work is to enable and encourage students in grades K-8 to walk and/or bicycle to and from school; to make walking and bicycling to school safer and more appealing; and to facilitate the planning, development, and implementation of projects that will improve safety and reduce traffic, fuel consumption, and air pollution in the vicinity of schools.
- C. If any changes are required due to conflict of design and or field conditions, the Engineer will make the final determination.
- D. The Contractor and all subcontractors, under this Contract, are prohibited from performing any work, other than specified in the Contract and/or directed by the Engineer, within the limits of the project site, without prior written notification to the Engineer. This includes any work for private or commercial entities.

### 1.03 LOCATION OF WORK

- A. The locations for work to be performed under the terms of this Contract are listed at the following Elementary Schools located on Miami-Dade County.
  - 1. Flagami Elementary, 920 SW 76 Avenue, Miami, FL 33144
  - 2. Carrie P. Meeck Westview K-8 Center, 2101 NW 127 St, Miami, FI 33167
  - 3. Shadowlawn Elementary, 149 NW 49 St, Miami, FI 33127
  - 4. Hubert O. Sibley K-8 Center, 255 NW 115 St, Miami, FI 33168
- B. The exact location and limits of construction are as shown on the Plans accompanying these Contract Documents.

#### 1.04 TIME FOR COMPLETION

- A. The Contract Times are stipulated in the Supplementary Conditions and may include applicable Milestones. The Work must be Substantially Completed within 305 days after the date when the Contract Time commences to run as provided in Subarticle 1.06 N of the General Requirements of the Specifications to the Contract Documents; and all requirements of the Contract Documents completed to the Engineer's satisfaction, including the completion of all punch list items, delivery to the Engineer of all required deliverable, and completion of any remaining Site restoration; and be ready for final payment within 365 days after the date when the Contract Time commences to run.

#### 1.05 PLANS

- A. Engineering Drawings titled "Safe Route to School Locations (Flagami Elementary, Carrie P. Meek Westview K-P Center, Shadowlawn Elementary and Hubert O. Sibley K-8), Miami-Dade County" are included with these Contract Documents. Additional standard details are available in the Miami-Dade County Public Works Manual and the latest edition of the Florida Department of Transportation's Design Standards for Design, Construction, Maintenance and Utility Operations on The State Highway System.
- B. The County through its Engineer shall have the right to modify the details and/or sketches, to supplement the sketches with additional plans and/or with additional information as work proceeds; all of which shall be considered as plans accompanying these Specifications herein generally referred to as the "Plans." In case of disagreement between the Plans and Specifications, the Engineer shall make a final determination as to which shall govern.

## **2. SPECIAL CONSTRUCTION REQUIREMENTS**

---

### 2.01 FIELD OFFICE

- A. A local field office is not required; however, the Contractor will be required to provide the Engineer with a local (Miami-Dade County) telephone, cellular or beeper number, where the Contractor may be contacted 24 hours a day, 7 days a week during the period for which the Contract is in force.

### 2.02 SCHOOL ZONE SPEED LIMIT BEACON ASSEMBLY

#### A. Description:

- 1. School Zone Speed Limit Beacon Assemblies meeting the physical display and operational requirements for warning or regulatory signs described in the Federal Highways Administration (FHWA) Manual on Uniform Traffic Control Devices (MUTCD) and its companion document, the Standard Highway Signs Book (SHS), the FDOT Section 700, the FDOT Standard Plans Index 700-10 and the Miami Dade County School Zone Speed Limit Beacon Assembly Details (Sheets 1 -3).

#### B. Method of Measurement.

- 1. The contract unit price for School Zone Speed Limit Beacon Assemblies is for a complete functional assembly meeting all the requirements herein, furnished and installed, that includes: all static sign panels; pull box and grounding; all mounting hardware; pedestal pole and base with reinforcing collar and foundation; required cabinets, controller, flashing beacons and housing; County-approved electronic remote scheduler/time-switch; electrical connection, miscellaneous appurtenances, and labor necessary for a complete and accepted installation. Price does not include an electrical power assembly.
- 2. When a solar-powered assembly is specified in the Contract Documents, the contract price will include the solar panel, batteries, and required electronics and mounting hardware.
- 3. When an Electronic Speed Feedback Sign (ESFS) is specified in the Contract Documents, the contract price will include the ESFS display and static panel and all required system components.

## 2.03 TRAFFIC SIGNALIZATION AND SIGNS

- A. In order to facilitate the readiness of these Solicitation Documents, the Department is including DTPW TSS specifications as Appendices of these Special Provisions. For the latest specifications of Traffic Control equipment, please refer to Miami-Dade County Traffic Signals and Signs Website under Traffic Signals Resources at <http://www.miamidade.gov/publicworks/traffic-signals.asp> or contact the Traffic Equipment and Specifications Engineer @ (305) 679-0006.

APPENDIX "A" TO SPECIAL PROVISIONS  
AUTHORIZATION AGREEMENT FOR AUTOMATIC DEPOSIT



## ACH AUTHORIZATION AGREEMENT FOR AUTOMATIC DIRECT DEPOSIT OF MIAMI-DADE COUNTY WARRANTS

We hereby authorize the Finance Department to initiate credit entries and, if necessary, a debit entry in order to reverse a credit entry made in error in accordance with NACHA rules.

**Original form** must be received before we can process your request for ACH deposits. Please refer to page 2 for instructions. Processing of the form is approximately 15 days from receipt of completed original form. This authority is to remain in effect until revoked in writing and received by the Finance Department. Account changes must be reported at a minimum **fifteen (15) days prior to actual change.**

### Section 1 (TO BE COMPLETED BY VENDOR) - ALL FIELDS ARE REQUIRED

TRANSACTION TYPE:                      New                       Change                       Terminate

**FEDERAL IDENTIFICATION NUMBER**

<table style="width: 100%; border-collapse: collapse;"> <tr> <td style="width: 20px; height: 20px; border: 1px solid black;"></td> <td style="width: 20px; height: 20px; border: 1px solid black;"></td> <td style="width: 20px; height: 20px; border: 1px solid black;"></td> <td style="width: 20px; height: 20px; border: 1px solid black;"></td> <td style="width: 20px; height: 20px; border: 1px solid black;"></td> <td style="width: 20px; height: 20px; border: 1px solid black;"></td> <td style="width: 20px; height: 20px; border: 1px solid black;"></td> <td style="width: 20px; height: 20px; border: 1px solid black;"></td> <td style="width: 20px; height: 20px; border: 1px solid black;"></td> <td style="width: 20px; height: 20px; border: 1px solid black;"></td> </tr> </table> <p style="text-align: center; font-size: small;">(AS PER CURRENT W-9)</p>											<table style="width: 100%; border-collapse: collapse;"> <tr> <td style="width: 20px; height: 20px; border: 1px solid black;"></td> <td style="width: 20px; height: 20px; border: 1px solid black;"></td> </tr> </table> <p style="text-align: center; font-size: small;">(FOR INTERNAL USE ONLY)</p>		

VENDOR NAME : \_\_\_\_\_

DBA (DOING BUSINESS AS) : \_\_\_\_\_

TELEPHONE NUMBER : \_\_\_\_\_

FISCAL OFFICER NAME AND TITLE : \_\_\_\_\_

FISCAL OFFICER'S EMAIL : \_\_\_\_\_

ACH NOTIFICATION EMAIL: \_\_\_\_\_

(This is the email where payment information will be sent)

**ROUTING NUMBER**

<table style="width: 100%; border-collapse: collapse;"> <tr> <td style="width: 20px; height: 20px; border: 1px solid black;"></td> <td style="width: 20px; height: 20px; border: 1px solid black;"></td> <td style="width: 20px; height: 20px; border: 1px solid black;"></td> <td style="width: 20px; height: 20px; border: 1px solid black;"></td> <td style="width: 20px; height: 20px; border: 1px solid black;"></td> <td style="width: 20px; height: 20px; border: 1px solid black;"></td> <td style="width: 20px; height: 20px; border: 1px solid black;"></td> <td style="width: 20px; height: 20px; border: 1px solid black;"></td> <td style="width: 20px; height: 20px; border: 1px solid black;"></td> <td style="width: 20px; height: 20px; border: 1px solid black;"></td> </tr> </table>											<table style="width: 100%; border-collapse: collapse;"> <tr> <td style="width: 20px; height: 20px; border: 1px solid black;"></td> <td style="width: 20px; height: 20px; border: 1px solid black;"></td> </tr> </table> <p style="text-align: center; font-size: small;">(FOR INTERNAL USE ONLY)</p>		

**VENDOR'S BANK ACCOUNT NUMBER**

<table style="width: 100%; border-collapse: collapse;"> <tr> <td style="width: 20px; height: 20px; border: 1px solid black;"></td> <td style="width: 20px; height: 20px; border: 1px solid black;"></td> <td style="width: 20px; height: 20px; border: 1px solid black;"></td> <td style="width: 20px; height: 20px; border: 1px solid black;"></td> <td style="width: 20px; height: 20px; border: 1px solid black;"></td> <td style="width: 20px; height: 20px; border: 1px solid black;"></td> <td style="width: 20px; height: 20px; border: 1px solid black;"></td> <td style="width: 20px; height: 20px; border: 1px solid black;"></td> <td style="width: 20px; height: 20px; border: 1px solid black;"></td> <td style="width: 20px; height: 20px; border: 1px solid black;"></td> </tr> </table>											<table style="width: 100%; border-collapse: collapse;"> <tr> <td style="width: 20px; height: 20px; border: 1px solid black;"></td> <td style="width: 20px; height: 20px; border: 1px solid black;"></td> </tr> </table> <p style="text-align: center; font-size: small;">(FOR INTERNAL USE ONLY)</p>		

TYPE OF ACCOUNT                      Checking                       Savings

AUTHORIZED SIGNATURE \_\_\_\_\_ DATE : \_\_\_\_\_

PRINTED NAME \_\_\_\_\_

A VOIDED CHECK OR REDACTED COPY OF A BANK STATEMENT FOR THE ACCOUNT LISTED ABOVE MUST BE PROVIDED. PLEASE REFER TO INSTRUCTIONS FOR OUR MAILING ADDRESS. SUBMISSION OF YOUR E-MAIL ADDRESS IS MANDATORY IN ORDER TO PARTICIPATE IN THIS PAYMENT OPTION.

### Section 2 (TO BE COMPLETED BY FINANCIAL INSTITUTION)

FINANCIAL INSTITUTION NAME: \_\_\_\_\_

ADDRESS: \_\_\_\_\_

BANK OFFICIAL NAME (PRINTED) AND TITLE : \_\_\_\_\_

TELEPHONE NUMBER : \_\_\_\_\_ EMPLOYEE ID NO. : \_\_\_\_\_

EMAIL : \_\_\_\_\_

I have verified that the account and routing number provided above is correct and corresponds to vendor noted above.

I have also verified that the person signing is an authorized signer on the account specified.

SIGNATURE \_\_\_\_\_ DATE : \_\_\_\_\_

### Section 3 (TO BE COMPLETED BY MIAMI-DADE FINANCE DEPARTMENT)

Accounts Payable Verifications	Cash Management	Input/Output
Corp. Officer Name : _____	Routing # verified by : _____	ACH Indicator updated by : _____
Verified by: _____	Date: _____	Date of Update : _____
A/P Staff: _____	Verified by : _____	Verified by : _____
Corp. Officer Title : _____	Verification Date: _____	Verification Date: _____
Date: _____		
Bank Officer: _____		
A/P Supervisor: _____		
Date: _____		



# ACH AUTHORIZATION AGREEMENT FOR AUTOMATIC DIRECT DEPOSIT OF MIAMI-DADE COUNTY WARRANTS

## INSTRUCTIONS

Please contact us at (305) 375-5111 or email at [FIN-ACHN@miamidade.gov](mailto:FIN-ACHN@miamidade.gov) if you have any questions or need assistance with this form.

You may obtain blank copies of this form at : [http://www.miamidade.gov/finance/library/ach\\_form.pdf](http://www.miamidade.gov/finance/library/ach_form.pdf)

At our Vendor Payment Inquiry (VPI) website you can obtain payment information as well as status of invoices, payment due date and other important information. You can reach the VPI site at :

<https://w85exp.miamidade.gov/VInvoice/login.do>

### Section 1

#### Transaction Type

New : If vendor is currently not on ACH deposits with Miami-Dade County.

Change : If vendor is currently on ACH deposits with Miami-Dade County and would like to make changes to their information ( example : change of financial institution, account number, etc.)

Terminate : If vendor is currently on ACH deposits with Miami-Dade County and would like to switch to either Check or AP Control disbursement type )

**Federal Identification Number** : Enter your Federal Employer Identification Number (FEIN) or Social Security Number (SSN) used to register you as a vendor with Miami-Dade County. Name and FEIN/SS must be exactly as provided on IRS Form W-9.

**Vendor Name** : Enter the name of your business or individual name used to register you as a vendor with Miami-Dade County.

**DBA (Doing Business As )** : If you have registered a DBA for your business or for you as an individual, please enter it here.

**Fiscal Officer Name, Title and E-Mail** : Name of Authorized Corporate officer, Title and E-Mail address to be contacted to. Corporate officer signing this form must be an authorized signatory in the corporate bank account listed on this form.

**ACH Notification E-Mail** : This is the E-Mail address where payment information will be sent to.

### Section 2

This section must be completed in full and legible manner by your banking institution in order to prevent delays in processing change to ACH.

Both acknowledgment statements must be checked off by Bank Official signing and dating the form.

### Section 3

This section will be completed by Miami-Dade County Finance Department.

#### ORIGINAL FORM AND VOIDED CHECK OR REDACTED STATEMENT MUST BE MAILED TO :

##### Accounts Payable Manager

**Miami-Dade County Finance Department**

**111 NW First Street, Suite 2620**

**Miami, Florida 33128**

#### Terms and Conditions

Completed form should not contain any changes (scratched off /white out) or altered information; otherwise, form will not be accepted.

Processing time is approximately fifteen (15) days from receipt of complete form and voided check or redacted Bank statement.

Providing account information does not authorize Miami-Dade County to access bank account activity.

ACH deposits can be made into **only** one (1) bank account. Payments can not be split between multiple accounts.

Notification E-mail providing payment information can be sent to one (1) single E-mail address **only**.

Proper verification will be conducted by Miami-Dade County Finance Department Staff, via a telephone call to confirm the information being provided is accurate.

This authorization shall remain in effect until terminated in writing with sufficient notice to Miami-Dade County Finance Department.

Miami-Dade County will not be responsible for any loss that may arise solely by reason of error, mistake or fraud regarding information provided on this ACH Authorization Agreement Form.



APPENDIX "B" TO SPECIAL PROVISIONS  
SECTION 600-GENERAL PROVISIONS FOR TRAFFIC CONTROL  
DEVICES

**SECTION 600**  
**GENERAL PROVISIONS FOR TRAFFIC CONTROL DEVICES**

**PART 1 GENERAL**

**1.01 DESCRIPTION**

- A. These Provisions are in addition to all applicable requirements of Division 01 (General Requirements) of the DTPW Specifications and supplement the Miami-Dade County Traffic Control Equipment Standards and Specifications and all other governing standards, requirements, and specifications.
- B. All work associated with the installation, modification or repairs of traffic control devices owned, operated or maintained by Miami-Dade County must conform to the requirements of these Provisions and the current requirements of the References listed below. The Engineer of Record and the Contractor performing the work are responsible for complying with all applicable requirements.

**1.02 REFERENCES**

- A. Miami-Dade County Traffic Control Equipment Standards and Specifications including Division 01 (General Requirements)
- B. FDOT Approved Product List (APL)
- C. Miami-Dade County Traffic Signals and Signs Division's Qualified Products List (TSSQPL)
- D. Florida Department of Transportation Standard Specifications for Road and Bridge Construction (Divisions II & III), Special Provisions and Supplemental Specifications
- E. FHWA Manual on Uniform Traffic Control Devices (MUTCD)
- F. National Electrical Code, NFPA 70 (NEC)

**1.03 DEFINITIONS**

- A. Engineer, defined in Subarticle 1.01.D of Division 01 (General Requirements) Miami-Dade County DTPW Specifications, includes the duly authorized representatives of the DTPW Traffic Signals and Signs (TSS) Division. Wherever these Provisions require either notification to or action by Engineer, it is understood to include the DTPW TSS Division authorized representative in addition to any other duly authorized DTPW representatives designated for the specific project.

**1.04 REGULATORY REQUIREMENTS**

- A. Permits.
  - 1. DTPW Permit(s) and written authorization from the DTPW Traffic Signals and Signs (TSS) Division are required before proceeding with any work pertaining to or that may potentially affect the Miami-Dade County Traffic Control System. Additional requirements regarding the performance and acceptance of the Work may be stipulated by the DTPW TSS Division.

**B. Notification.**

1. Provide written and verbal notification to the DTPW TSS Division:
  - a. Ten business days prior to commencement of any construction, modification or repair of any component within the Miami-Dade County traffic control system.
  - b. Five business days prior to the commencement of jobs that include overhead or underground work conducted as part of construction or maintenance projects within Miami-Dade County roadways or other roadways within the County whose traffic control devices are maintained by Miami-Dade County.
2. Notification is provided at:

Department of Transportation and Public Works  
Traffic Signals and Signs Division (Attn: WRITTEN NOTIFICATION)  
7100 NW 36th Street  
Miami, FL 33166

Phone: 305-679-0041
3. Provide immediate verbal notice followed by written notification to the DTPW TSS Division upon the discovery of any damage, malfunctions, or irregularities pertaining to any Miami-Dade County Traffic Control System component.

**C. Preliminary Product and Equipment Data Submittals.**

1. Prior to installation or within thirty days after the preconstruction conference, whichever comes first, submit to Engineer for approval:
  - a. A completed "Submittal Data – Traffic Control Equipment" form listing, by FDOT APL numbers, all traffic control signals, devices, and hardware that will be used on the Project. Only current FDOT APL certified items that have also been approved and currently listed in the TSSQPL may be used.
  - b. One copy of the manufacturer's descriptive literature and technical data fully describing proposed non-structural equipment or material whose category or type does not require FDOT APL certification or TSSQPL approval.
  - c. Two copies of the shop drawings signed and sealed by the Specialty Engineer. Shop drawings are required for all structural support materials and other special designs, such as non-electrical, non-mechanical, or other fabricated items, which may not be specifically detailed in the Plans.

**D. Transfer of Maintenance Responsibilities.**

1. Fully maintain all traffic control devices located within the Project limits, including any interconnect, beginning on the date of the Notice to Proceed or the date Contractor has begun any work on any portion of the Project, whichever is sooner, through and including the date of Final Acceptance by the County subject to any additional Contractor Warranty and Burn-in Period requirements. Investigate all inquiries, complaints or requests made by the County or the Public and immediately initiate all required repairs.
2. Notify Engineer of intent to begin any physical construction work on the Project or any portion thereof. This notification must be a minimum of seven (7) working days prior to the start of construction to allow sufficient time for Contractor to conduct an inspection of the existing traffic control device installation(s). In the event any deficiencies are

noted by Contractor, at the County's option, they are to be repaired by the TSS Division or documented on the "Transfer of Maintenance" form. If work is started prior to the inspection, maintenance of the traffic control device(s) will immediately be transferred to Contractor without an inspection. Contractor is then responsible for repairing or replacing all equipment that is not operating properly or is damaged at no cost to the owner of the traffic control device.

3. For new traffic control devices, partial or final acceptance and inspection must be scheduled with the County Project Manager before the traffic control device is placed in normal operational mode. Notification is also required before placing the signal in the flashing mode.

E. Emergency and Non-Emergency Repairs

1. Provide Engineer two (2) contact names and (24-hour) telephone numbers. Contractor must provide sufficient qualified personnel to respond to all notifications of malfunctions on a round-the-clock basis (24 hours a day, 7 days a week).
2. Maintain and make available to Engineer a time and date log of each response from the time of the initial report to the time of final permanent repair.
3. When a signal malfunction occurs, Contractor must respond within two hours of notification and repair the traffic signal so that it is operating in a safe manner within four hours of initial notification. Contractor is responsible for the permanent repair within 24 hours, and must notify the County immediately upon completion of the repairs. If Contractor fails to respond within two hours, the County reserves the right to either repair the malfunction or employ alternate personnel and charge all costs incurred by the County to the Contractor.
4. Authorized County personnel may, at any time, enter the controller cabinet in order to modify timing or restore any and all signal equipment to proper operation if the malfunction or non-function of such equipment poses a hazard or inconvenience to motorists or pedestrians. Such authorized entry may occur at any time within the period of the contract, and such authorized entry will in no way relieve the Contractor or manufacturer of their respective warranties.
5. Emergency Repairs
  - a. During the Transfer of Maintenance period, the following will be considered an Emergency unless otherwise identified by Engineer:
    - 1) Any hazardous condition;
    - 2) Any malfunction of a controller and its accessory equipment; or
    - 3) Any Site condition, equipment malfunctions or damage, which in the opinion of Engineer constitutes a serious hazard or inconvenience to the public.
  - b. Contractor must dispatch personnel to undertake each such repair no later than thirty (30) minutes after the County notifies Contractor of the Emergency. Personnel responding must arrive within one hour after notification and immediately proceed to make the site safe.

**1.05 LICENSES AND QUALIFICATIONS**

A. Qualifications

1. Contractor license requirement.
  - a. Contractor must hold either a Miami-Dade County Electrical Contractor License or a State of Florida Certified Electrical Contractor License, or both.

2. Minimum qualifications for personnel supervising or performing work involving electrical Traffic Control Devices and related components or appurtenances.
  - a. All work must be performed under the direction of an employee of the Contractor who is a licensed Miami-Dade County Master Electrician, is present at the job site or able to respond within 2 hours of notification, and holds a current International Municipal Signal Association (IMSA) Traffic Signal Field Technician Level II certification or higher. The Master electrician is required to attest to the quality and accuracy of the Work and its compliance with all applicable codes, standards and specifications; and when required by Miami-Dade County, perform a final verification inspection of the Work.
  - b. Minimum qualification requirements for personnel at the job site:

Work Performed	Qualification Requirements
Contractor's Superintendent	<ol style="list-style-type: none"> <li>1. Must meet all applicable FDOT and DTPW requirements for a work site superintendent and be at the job site at all times that work is being performed;</li> <li>2. Must hold a current IMSA Traffic Signal Construction Technician Level II certification or higher; and</li> <li>3. Must be present at the final inspection of the Work as directed by Miami-Dade County.</li> </ol>
All controller cabinet work including back panel wiring terminations; programming; testing; turn on; and troubleshooting.	<ol style="list-style-type: none"> <li>1. Work must be performed by an employee of the Contractor that is a licensed Miami-Dade County Journeyman Electrician and that holds a current IMSA Traffic Signal Field Technician Level II certification or higher; and</li> <li>2. Must be present at the final inspection of the Work as directed by Miami-Dade County.</li> </ol>
Electrical traffic control device work including cable and wire installation and splices; signal head installation; power service installation; ground rod testing; cable and wire testing; and field wiring terminations.	<ol style="list-style-type: none"> <li>1. Work must be performed by or in the presence of and under the responsible charge of an employee of the Contractor that is a licensed Miami-Dade County Journeyman Electrician and that holds a current IMSA Traffic Signal Field Technician Level II certification or higher; and</li> <li>2. Must be present at the final inspection of the Work as directed by Miami-Dade County.</li> </ol>
Supervision of work that is non-electrical in nature and exclusively ancillary to the work described herein	<ol style="list-style-type: none"> <li>1. Must be performed by an employee of the Contractor that holds a current IMSA Traffic Signal Field Technician Level I certification or higher.</li> </ol>

3. Training and Certifications for Temporary Traffic Control
  - a. The following certifications from FDOT approved providers are required:
    - 1) Contractor's designated Worksite Traffic Supervisor must have a current FDOT MOT Advanced certification. Contractor's IMSA Traffic Signal Construction Technicians and Traffic Signal Field Technicians described in Paragraph "A.2" above, including the licensed Journeyman and Master

electricians, must have a current FDOT MOT Intermediate certification or higher.

- 2) Contractor's designated Flaggers must have a current FDOT MOT Basic certification.
  4. Provide to the DTPW TSS Division for review and approval an updated list of names of all personnel assigned to perform the work along with current copies of their required licenses and certification cards, before starting any work. In addition, ensure that these personnel have copies of their licenses and certifications available at the work site and ready to make them available to DTPW personnel if requested.
- B. Qualified Technical Representative of the Control Equipment Manufacturer.
1. A qualified technical representative of the control equipment manufacturer is required to be present at the work site to assist in checking out the operation of the controller whenever:
    - a. A Contractor-furnished traffic signal controller is turned on; or
    - b. An existing Signal is revised requiring Contractor furnished control equipment.

**1.06 ACCEPTANCE OF TRAFFIC CONTROL SIGNAL AND DEVICE INSTALLATIONS.**

- A. Engineer will make inspection for final acceptance of traffic control signal and device installations as part of all work only after satisfactory completion of all field tests of completed installations and on the basis of a comprehensive final field inspection of all equipment installations.
- B. Submit three copies of a completed Submittal Data – Traffic Control Equipment form for each cabinet location, to Engineer. Engineer will place one copy in the cabinet at each location.
- C. Transfer warranties and guarantees on equipment to the Department in accordance with this Section.
- D. For traffic signal installations, submit three completed copies of the Final Acceptance of Traffic Signal Installation(s) and Transfer of Maintenance form.
- E. Documentation for Electronic Equipment.
  1. Required Documentary Items.
    - a. Operation Manual
    - b. Troubleshooting and Service Manual
    - c. Assembly and installation instructions
    - d. Pictorial layout of components and schematics for circuit boards
    - e. Parts list
    - f. Diagram of the field installation wiring (not applicable to the detectors)
    - g. Warranty information
  2. Prior to final inspection, furnish Engineer with two copies of the aforementioned documentary items from the manufacturer for the following electronic equipment:
    - a. Controllers
    - b. Vehicle detectors
    - c. Load switches

- d. Flasher units
- e. Preemption units
- f. Conflict monitors
- g. Special sequence relays
- h. Cameras
- i. Dynamic message signs
- j. Any other equipment which has a logic, timing, or communications function
- k. Other equipment specified in the Contract Documents

F. As-Built Drawings.

1. As a condition precedent to acceptance, provide signed and sealed As-Built Drawings, either by a State of Florida licensed professional engineer or a professional surveyor and mapper, and prepared pursuant to Subarticle 1.06.I of Division 01 (General Requirements) of the DTPW Specifications. These drawings must show the actual location of all signal poles, mast arms, traffic control devices, signs, cabinets, service points and must clearly depict all installations including the depth and location of all conduits and conductors; and the specific product number installed.
2. Submittal Requirements:
  - a. Submit three sets of as-built plans for review by Engineer along with electronic copies consisting of a separate level/layer within the project design files. Coordinate the format of electronic as-built files with Engineer. Record all as-built information using typed text to ensure legibility.
  - b. The As-Built plans shall be neat, legible and of the correct size. Bridge projects and any road projects which include Plan, Profile and Cross-Section Sheets must be full size (22" X 36"). In general, if the job was let with full size plans, the As-Built must be full size. All revisions to the original plans must be delineated in red, located properly on the drawing, they must be legible and true to scale. Every As-Built Plan, Profile and Cross-section Sheet must be designated as such by note or stamp "As-Built" in black.
  - c. Signing and pavement marking plan sheets may be used instead of signalization plan sheets, if a substantial number of changes from the original plans must be recorded. If, in the opinion of the Engineer, the changes cannot be clearly delineated on the existing drawings, clearly delineate all changes on 11 inch by 17 inch detail sheets, enlarged 200% from the reproductions.
  - d. Submit fiber optic splicing diagrams detailing all cable splices, terminations, equipment port assignments, and optical circuits within the communication network.
  - e. As-built submittals must include an electronic file with an inventory of all traffic control signals and devices, and support structures. The inventory must include horizontal position geographic coordinate data collected using Differential Global Positioning System (DGPS) equipment. The inventory must include the manufacturer, model, and serial number for each device or completed assembly. Provide coordinate data for pull boxes as well as conduit and cable at 100 foot intervals including changes in direction.
  - f. Aerial photographs may be furnished with as-built submittals to provide supplementary information. The aerials should not include extra features such as the right of way, baseline, or roadway edges. The aerials may be used as a base for the as-built plans with mile post and offset dimensions. Make any corrections resulting from Engineer's review, and resubmit three sets of the completed as-built plans as a condition precedent to acceptance of the installation.

3. Components: As a minimum, identify all traffic control devices, poles, support structures, cabinets, pull and splice boxes, hubs, access points, and power services.
  - a. Conduit and Cable: Identify all conduit and cable with unique line styles for routing (overhead, conduit, saw cut, etc.) that are clearly identified in a legend on each sheet. Identify the type of cable (example - 7 conductor signal cable) and label the number of conductors, fiber strands or other identifying features of the cable. For conduit, clearly note conduit size and number of runs.
  - b. Loops and Detection Zones: Identify the location of all installed loops (including the distance from the stop bar for the advance loops), the path of each loop to the pull box, the loop window and the path of the loop lead-in to the controller cabinet. Identify the device location and the approximate detection area for detection systems that are not embedded in or under pavement.
  - c. Pull Boxes: Label unused and out of service pull boxes clearly. Show distances to each pull box from the nearest edgeline, stop bar, or other permanent feature. If an edgeline is not near a pull box or would not clearly identify its location; a fixed monument may be used (example - FDOT pole or structure).
  - d. Poles: Identify poles from the nearest edgeline of both approaches. If an edgeline is not near a pole or would not clearly identify its location, a fixed monument may be used.
  - e. Signal Heads: As-built plans must show the final location of signal heads. Each signal head shall be identified by its corresponding movement number.
  - f. Cabinet: The type of cabinet, date of installation and inventory of internal components must be documented. Controller manufacturer along with the controller model number shall be provided for all traffic signal cabinets. A cabinet corner "blow up" shall be provided detailing pull box locations with all conduit and cable.

## 1.07 MANUFACTURERS' WARRANTY PROVISIONS

### A. General.

1. Manufacturer and Contractor costs associated with transferring, providing, and delivering equipment warranties, requirements, terms, and conditions are part of the Work and are included in the overall cost of the Work or where available, in the pay item for the equipment or construction feature utilizing the equipment.
2. Secure all warranties provided by the equipment manufacturer for the specific equipment included in the Contract. Ensure that all warranties are fully transferable from the Contractor to the owner of the equipment within the project limits. Ensure that warranties cover defects for at least the duration specified in the Contract Documents from the date of Final Acceptance in accordance with the applicable Contract Provisions.
3. Transfer warranties upon Final Acceptance. Document all warranties and warranty transfers and provide a copy to Engineer.
4. Contractor's responsibility for warranty repairs, warranty replacement, troubleshooting, or other costs associated with repair or replacement of traffic control signals and devices within the Contract's project limits will terminate 90 days after Final Acceptance.

### B. Terms and Conditions.

1. Ensure that the terms and conditions of warranties are documented by the manufacturer for equipment submittals on construction projects. Include terms for a



specified service performance with provisions for repair parts and labor, or for replacement.

2. Ensure that warranties and guarantees are consistent with those provided as customary trade practices; or as otherwise specified in the Plans, Standard Specifications, Supplemental Specifications or Special Provisions.
3. When a warranty is available, ensure that a written warranty accompanies the manufacturer's billing invoice. Ensure warranties require the manufacturer to furnish replacements for any part or equipment found to be defective during the manufacturer's warranty period at no cost to the owner of the equipment within the project limits.
4. Ensure that manufacturer's and supplier's warranties and guarantees are transferable to the agency or user that is responsible for traffic signal maintenance, are continuous throughout their duration and state that they are subject to such transfer.
5. Ensure the manufacturer will repair any faulty equipment during this period at no charge to the Department for parts, labor or shipping to and from the factory.

## **PART 2 PRODUCTS**

### **2.01 EQUIPMENT AND MATERIALS.**

#### **A. General.**

1. Ensure that the traffic signal equipment, materials, and work meet the requirements of the Plans and Specifications. All equipment furnished must be new and meet the requirements of the following:
  - a. Underwriter's Laboratory Incorporated (UL)
  - b. Electronic Industries Association (EIA)
  - c. National Electric Code (NEC)
  - d. American Society of Testing and Materials (ASTM)
  - e. American National Standards Institute (ANSI)
  - f. International Municipal Signal Association (IMSA)
  - g. National Electrical Manufacturers Association (NEMA)
2. Use only compatible units of any one item of equipment, such as signal heads, detectors, controllers, cabinets, poles, signal system or interconnection equipment, etc.
3. Use only new equipment and material.
4. Provide a complete operable signal installation as specified regardless of any failure of the Department to discover or note any unsatisfactory material.
5. Traffic control signals and devices must be currently approved and listed on the FDOT APL and the DTPW TSSQPL. Contractor may seek acceptance and inclusion of new traffic control signals and devices in the TSSQPL however; doing so will not exempt Contractor from meeting all requirements of the Contract Documents including timely prosecution of the Work.

#### **B. Hardware and Fittings Used for Installation.**

1. Ensure that all assembly hardware, including nuts, bolts, external screws and locking washers less than 5/8 inch in diameter, are Type 304 or 316 passivated stainless steel. Use stainless steel bolts, screws and studs meeting the requirements of ASTM F593. Use nuts meeting the requirements of ASTM F594. Ensure all assembly hardware greater than or equal to 5/8 inch in diameter is galvanized. Use bolts, studs, and threaded rod meeting the requirements of ASTM A307. Use structural bolts meeting the requirements of ASTM A325.
  2. Use high-strength steel anchor bolts and U-bolts, having a minimum yield strength of 55,000 psi and a minimum ultimate strength of 90,000 psi.
- C. Galvanizing: Meet the requirements of FDOT Section 962 when galvanizing for fittings and appurtenances for all structural steel (including steel poles).
- D. Environmental Specifications: Ensure system electronics intended for installation outdoors or within a roadside cabinet perform all required functions during and after being subjected to the environmental testing described in National Electrical Manufacturers Association (NEMA) TS2, 2.2.7, 2.2.8, and 2.2.9.

**2.02 DEPARTMENT-FURNISHED EQUIPMENT INSTALLED BY CONTRACTOR.**

- A. Where the Contract Documents require installation of Department-furnished equipment, the Department will turn over such equipment to Contractor when the construction progress allows or as designated in the Contract Documents.
- B. The Department will test and certify the equipment to be in proper condition and ready to use and will bear the costs of correcting any defects in the equipment prior to pick-up by Contractor. Engineer will coordinate the pick-up and installation of the equipment.
- C. Maintain the equipment in proper operational condition after pick-up at no cost to the Department, until either Final Acceptance or the equipment is returned to the Department.

**PART 3 EXECUTION (NOT USED)**

**END OF SECTION 600**

APPENDIX "C" TO SPECIAL PROVISIONS  
SECTION 120: EARTHWORK AND RELATED OPERATIONS FOR LAP  
(OFF-SYSTEM)

**EARTHWORK AND RELATED OPERATIONS FOR LAP (OFF-SYSTEM).**  
**(REV 1-23-12) (FA 2-27-12)**

**SECTION 120**  
**EARTHWORK AND RELATED OPERATIONS FOR LAP (OFF-SYSTEM)**

**120-1 Description.**

**120-1.1 General:** Perform earthwork and related operations based on the type of work specified in the Contract and the Earthwork Categories as defined below. Meet the applicable requirements for materials, equipment and construction as specified.

Earthwork and related operations consists of excavation for the construction of the roadway, excavation for structures and pipe, constructing backfill around structures and pipe, and constructing embankments as required for the roadway, ditches, and channel changes.

**120-1.2 Earthwork Categories:** Performance of Earthwork Operations will fall into one of the following Earthwork Categories:

**120-1.2.1 Earthwork Category 1:** Includes the earthwork and related operations associated with the construction of sidewalks and bike paths along with any drainage structures associated with these facilities.

**120-1.2.2 Earthwork Category 2:** Includes the earthwork and related operations associated with the construction of turn lanes and other non-mainline traffic lanes, widening, roadway shoulders, concrete box culverts, retaining walls, and other drainage structures on the non-mainline pavement.

**120-1.2.3 Earthwork Category 3:** Includes the earthwork and related operations associated with the construction of new mainline pavement, along with concrete box culverts, retaining walls, and other drainage structures on the mainline pavement.

**120-2 Classes of Excavation.**

**120-2.1 Excavation of Unsuitable Material:** Excavation of unsuitable material consists of the removal of muck, clay, rock or any other material that is unsuitable in its original position and that is excavated below the finished grading template. For stabilized bases and sand bituminous road mixes, the finished grading template is the top of the finished base, shoulders and slopes. For all other bases and rigid pavement, the finished grading template is the finished shoulder and slope lines and bottom of completed base or rigid pavement.

**120-2.2 Lateral Ditch Excavation:** Lateral ditch excavation consists of all excavation of inlet and outlet ditches to structures and roadway, changes in channels of streams, and ditches parallel to the roadway right-of-way. Dress lateral ditches to the grade and cross-section shown in the plans.

**120-2.3 Channel Excavation:** Channel excavation consists of the excavation and satisfactory disposal of all materials from the limits of the channel as shown in the plans.

**120-2.4 Excavation for Structures and Pipe:** Excavation for structures consists of the excavation for bridge foundations, box culverts, pipe culverts, storm sewers and all other pipe lines, retaining walls, headwalls for pipe culverts and drains, catch basins, drop inlets, manholes, and similar structures.

### **120-3 Excavation Requirements.**

**120-3.1 Excavation and Replacement of Unsuitable Materials:** Where rock, muck, clay, or other material within the limits of the roadway is unsuitable in its original position, excavate such material to the cross-sections shown in the plans or indicated by the Engineer, and backfill with suitable material. Shape backfill materials to the required cross-sections. Where the removal of plastic soils below the finished earthwork grade is required, meet a construction tolerance of plus or minus 0.2 foot in depth and plus or minus 6 inches (each side) in width.

**120-3.2 Lateral Ditch Excavation:** Excavate inlet and outlet ditches to structures and roadway, changes in channels of streams and ditches parallel to the roadway. Dress lateral ditches to the grade and cross-section shown in the plans.

**120-3.3 Channel Excavation:** Excavate and dispose of all materials from the limits of the channel as shown in the plans. Excavate for bridge foundations, box culverts, pipe culverts, storm sewers and all other pipe lines, retaining walls, headwalls for pipe culverts and drains, catch basins, drop inlets, manholes, and similar structures.

#### **120-3.4 Excavation for Structures and Pipe.**

**120-3.4.1 Requirements for all Excavation:** Excavate foundation pits to permit the placing of the full widths and lengths of footings shown in the plans, with full horizontal beds. Do not round or undercut corners or edges of footings. Perform all excavation to foundation materials, satisfactory to the Engineer, regardless of the elevation shown on the plans. Perform all excavation in stream beds to a depth at least 4 feet below the permanent bed of the stream, unless a firm footing can be established on solid rock before such depth is reached, and excavate to such additional depth as may be necessary to eliminate any danger of undermining. Wherever rock bottom is secured, excavate in such manner as to allow the solid rock to be exposed and prepared in horizontal beds for receiving the masonry. Remove all loose and disintegrated rock or thin strata. Have the Engineer inspect and approve all foundation excavations prior to placing masonry.

#### **120-3.4.2 Earth Excavation:**

**120-3.4.2.1 Foundation Material other than the Rock:** When masonry is to rest on an excavated surface other than rock, take special care to avoid disturbing the bottom of the excavation, and do not remove the final foundation material to grade until just before placing the masonry. In case the foundation material is soft or mucky, the Engineer may require excavation to a greater depth and to backfill to grade with approved material.

**120-3.4.2.2 Foundation Piles:** Where foundation piles are used, complete the excavation of each pit before driving the piles. After the driving is completed, remove all loose and displaced material, leaving a smooth, solid, and level bed to receive the masonry.

**120-3.4.2.3 Removal of Obstructions:** Remove boulders, logs, or any unforeseen obstacles encountered in excavating.

**120-3.4.3 Rock Excavation:** Clean all rock and other hard foundation material, remove all loose material, and cut all rock to a firm surface. Either level, step vertically and horizontally, or serrate the rock, as may be directed by the Engineer. Clean out all seams, and fill them with concrete or mortar.

**120-3.4.4 Pipe Trench Excavation:** Excavate trenches for pipe culverts and storm sewers to the elevation of the bottom of the pipe and to a width sufficient to provide adequate working room. Remove soil not meeting the classification specified as suitable backfill material in 120-8.3.2.2 to a depth of 4 inches below the bottom of the pipe elevation. Remove rock, boulders or other hard lumpy or unyielding material to a depth of 12 inches below the

bottom of the pipe elevation. Remove muck or other soft material to a depth necessary to establish a firm foundation. Where the soils permit, ensure that the trench sides are vertical up to at least the mid-point of the pipe.

For pipe lines placed above the natural ground line, place and compact the embankment, prior to excavation of the trench, to an elevation at least 2 feet above the top of the pipe and to a width equal to four pipe diameters, and then excavate the trench to the required grade.

#### **120-4 Disposal of Surplus and Unsuitable Material.**

**120-4.1 Ownership of Excavated Materials:** Dispose of surplus and excavated materials as shown in the plans or, if the plans do not indicate the method of disposal, take ownership of the materials and dispose of them outside the right-of-way.

**120-4.2 Disposal of Muck on Side Slopes:** As an exception to the provisions of 120-4.1, when approved by the Engineer, muck (A-8 material) may be placed on the slopes, or stored alongside the roadway, provided there is a clear distance of at least 6 feet between the roadway grading limits and the muck, and the muck is dressed to present a neat appearance. In addition, this material may also be disposed of by placing it on the slopes where, in the opinion of the Engineer, this will result in an aesthetically pleasing appearance and will have no detrimental effect on the adjacent developments. Where the Engineer permits the disposal of muck or other unsuitable material inside the right-of-way limits, do not place such material in a manner which will impede the inflow or outfall of any channel or of side ditches. The Engineer will determine the limits adjacent to channels within which such materials may be disposed.

**120-4.3 Disposal of Paving Materials:** Unless otherwise noted, take ownership of paving materials, such as paving brick, asphalt block, concrete slab, sidewalk, curb and gutter, etc., excavated in the removal of existing pavements, and dispose of them outside the right-of-way. If the materials are to remain the property of the Agency, place them in neat piles as directed. Existing limerock base that is removed may be incorporated in the stabilized portion of the subgrade. If the construction sequence will allow, incorporate all existing limerock base into the project as allowed by the Contract Documents.

**120-4.4 Disposal Areas:** Where the Contract Documents require disposal of excavated materials outside the right-of-way, and the disposal area is not indicated in the Contract Documents, furnish the disposal area without additional compensation.

Provide areas for disposal of removed paving materials out of sight of the project and at least 300 feet from the nearest roadway right-of-way line of any road. If the materials are buried, disregard the 300 foot limitation.

#### **120-5 Materials for Embankment.**

**120-5.1 General Requirements for Embankment Materials:** Construct embankments using suitable materials excavated from the roadway or delivered to the jobsite from authorized borrow pits.

Construct the embankment using maximum particle sizes as follows:

In top 12 inches: 3 1/2 inches (in any dimension).

12 to 24 inches: 6 inches (in any dimension).

In the depth below 24 inches: not to exceed 12 inches (in any dimension) or the compacted thickness of the layer being placed, whichever is less.

Spread all material so that the larger particles are separated from each other to minimize voids between them during compaction. Compact around these rocks in accordance with 120-7.2.

When and where approved by the Engineer, larger rocks (not to exceed 18 inches in any dimension) may be placed outside the one to two slope and at least 4 feet or more below the bottom of the base. Compact around these rocks to a firmness equal to that of the supporting soil. Where constructing embankments adjacent to bridge end bents or abutments, do not place rock larger than 3 1/2 inches in diameter within 3 feet of the location of any end-bent piling.

**120-5.2 Use of Materials Excavated From the Roadway and Appurtenances:** Assume responsibility for determining the suitability of excavated material for use on the project in accordance with the applicable Contract Documents. Consider the sequence of work and maintenance of traffic phasing in the determination of the availability of this material.

**120-5.3 Authorization for Use of Borrow:** Use borrow only when sufficient quantities of suitable material are not available from roadway and drainage excavation, to properly construct the embankment, subgrade, and shoulders, and to complete the backfilling of structures and pipe. Do not use borrow material until so ordered by the Engineer, and then only use material from approved borrow pits.

**120-5.3.1 Haul Routes for Borrow Pits:** Provide and maintain, at no expense to the Agency, all necessary roads for hauling the borrow material. Where borrow area haul roads or trails are used by others, do not cause such roads or trails to deteriorate in condition.

Arrange for the use of all non-public haul routes crossing the property of any railroad. Incur any expense for the use of such haul routes. Establish haul routes which will direct construction vehicles away from developed areas when feasible, and keep noise from hauling operations to a minimum. Advise the Engineer in writing of all proposed haul routes.

**120-5.3.2 Borrow Material for Shoulder Build-up:** When so indicated in the plans, furnish borrow material with a specific minimum bearing value, for building up of existing shoulders. Blend materials as necessary to achieve this specified minimum bearing value prior to placing the materials on the shoulders. Take samples of this borrow material at the pit or blended stockpile.

**120-5.4 Materials Used at Pipes, Culverts, etc.:** Construct embankments over and around pipes, culverts, and bridge foundations with selected materials.

## **120-6 Embankment Construction.**

**120-6.1 General:** Construct embankments in sections of not less than 300 feet in length or for the full length of the embankment.

### **120-6.2 Dry Fill Method:**

**120-6.2.1 General:** Construct embankments to meet compaction requirements in 120-7 and in accordance with the acceptance program requirements in 120-9. Restrict the compacted thickness of the last embankment lift to 6 inches maximum.

As far as practicable, distribute traffic over the work during the construction of embankments so as to cover the maximum area of the surface of each layer.

Construct embankment in the dry whenever normal dewatering equipment and methods can accomplish the needed dewatering.

#### **120-6.2.1.1 For A-3 and A-2-4 Materials with up to 15% fines:**

Construct the embankment in successive layers with lifts up to a maximum compacted thickness of 12 inches. Ensure the percentage of fines passing the No. 200 US Standard sieve in the A-2-4 material does not exceed 15%.

**120-6.2.1.2 For A-1 Plastic materials (As designated in FDOT Design Standard Index 505) and A-2-4 Materials with greater than 15% fines:** Construct the embankment in successive layers with lifts up to a maximum compacted thickness of 6 inches.

**120-6.2.1.3 Equipment and Methods:** Provide normal dewatering equipment including, but not limited to, surface pumps, sump pumps and trenching/digging machinery. Provide normal dewatering methods including, but not limited to, constructing shallow surface drainage trenches/ditches, using sand blankets, sumps and siphons.

When normal dewatering does not adequately remove the water, the Engineer may require the embankment material to be placed in the water or in low swampy ground in accordance with 120-7.2.4.

**120-6.2.2 Placing in Unstable Areas:** Where depositing the material in water, or in low swampy ground that will not support the weight of hauling equipment, construct the embankment by dumping successive loads in a uniformly distributed layer of a thickness not greater than necessary to support the hauling equipment while placing subsequent layers. Once sufficient material has been placed so that the hauling equipment can be supported, construct the remaining portion of the embankment in layers in accordance with the applicable provisions of 120-7.2.4 and 120-7.2.6.

**120-6.2.3 Placing on Steep Slopes:** When constructing an embankment on a hillside sloping more than 20 degrees from the horizontal, before starting the fill, deeply plow or cut into steps the surface of the original ground on which the embankment is to be placed.

**120-6.2.4 Placing Outside Standard Minimum Slope:** Where material that is unsuitable for normal embankment construction is to be used in the embankment outside the standard minimum slope (approximately one to two), place such material in layers of not more than 18 inches in thickness, measured loose. The Contractor may also place material which is suitable for normal embankment, outside such standard minimum slope, in 18 inch layers. Maintain a constant thickness for suitable material placed within and outside the standard minimum slope, unless placing in a separate operation.

### **120-6.3 Hydraulic Method:**

**120-6.3.1 Method of Placing:** When the hydraulic method is used, as far as practicable, place all dredged material in its final position in the embankment by such method. Place and compact any dredged material that is re-handled, or moved and placed in its final position by any other method, as specified in 120-7.2. The Contractor may use baffles or any form of construction he may select, provided the slopes of the embankments are not steeper than indicated in the plans. Remove all timber used for temporary bulkheads or baffles from the embankment, and fill and thoroughly compact the holes thus formed. When placing fill on submerged land, construct dikes prior to beginning of dredging, and maintain the dikes throughout the dredging operation.

**120-6.3.2 Excess Material:** Do not use excess material placed outside the prescribed slopes, below the normal high-water level, to raise the fill. Remove only the portion of this material required for dressing the slopes.

**120-6.3.3 Protection of Openings in Embankment:** Leave openings in the embankments at the bridge sites. Remove any material which invades these openings or existing channels without additional compensation to provide the same depth of channel as existed before the construction of the embankment. Do not excavate or dredge any material within 200 feet of the toe of the proposed embankment.



## **120-7 Compaction Requirements.**

**120-7.1 Moisture Content:** Compact the materials at a moisture content such that the specified density can be attained. If necessary to attain the specified density, add water to the material, or lower the moisture content by manipulating the material or allowing it to dry, as is appropriate.

### **120-7.2 Compaction of Embankments:**

**120-7.2.1 Earthwork Category 1 and 2 Density Requirements:** The Engineer will accept a minimum density of 95% of the maximum density as determined by AASHTO T-99 Method C for all earthwork items requiring densities.

**120-7.2.2 Earthwork Category 3 Density Requirements:** The Engineer will accept a minimum of 100% of the maximum density as determined by AASHTO T-99 Method C for all densities required under category 3.

Except for embankments constructed by the hydraulic method as specified in 120-6.3, and for the material placed outside the standard minimum slope as specified in 120-6.2.4, and for other areas specifically excluded herein, compact each layer of the material used in the formation of embankments to the required density stated above. Uniformly compact each layer using equipment that will achieve the required density, and as compaction operations progress, shape and manipulate each layer as necessary to ensure uniform density throughout the embankment.

**120-7.2.3 Compaction Over Unstable Foundations:** Where the embankment material is deposited in water or on low swampy ground, and in a layer thicker than 12 inches (as provided in 120-6.2.2), compact the top 6 inches (compacted thickness) of such layer to the density as specified in 120-9.5.

**120-7.2.4 Compaction Where Plastic Material Has Been Removed:** Where unsuitable material is removed and the remaining surface is of the A-4, A-5, A-6, or A-7 Soil Groups, as determined by the Engineer, compact the surface of the excavated area by rolling with a sheepsfoot roller exerting a compression of at least 250 psi on the tamper feet, for the full width of the roadbed (subgrade and shoulders). Perform rolling before beginning any backfill, and continue until the roller feet do not penetrate the surface more than 1 inch. Do not perform such rolling where the remaining surface is below the normal water table and covered with water. Vary the procedure and equipment required for this operation at the discretion of the Engineer.

**120-7.2.5 Compaction of Material To Be Used In Base, Pavement, or Stabilized Areas:** Do not compact embankment material which will be incorporated into a pavement, base course, or stabilized subgrade, to be constructed as a part of the same Contract.

**120-7.2.6 Compaction of Grassed Shoulder Areas:** For the upper 6 inch layer of all shoulders which are to be grassed, since no specific density is required, compact only to the extent directed.

**120-7.2.7 Compaction of Grassed Embankment Areas:** For the outer layer of all embankments where plant growth will be established, do not compact. Leave this layer in a loose condition to a minimum depth of 6 inches for the subsequent seeding or planting operations.

**120-7.3 Compaction of Subgrade:** If the plans do not provide for stabilizing, compact the subgrade in both cuts and fills to the density specified in 120-9.5. For undisturbed soils, do not apply density requirements where constructing narrow widening strips or paved shoulders 5 feet or less in width.

Where trenches for widening strips are not of sufficient width to permit the use of standard compaction equipment, perform compaction using vibratory rollers, trench rollers, or other type compaction equipment approved by the Engineer.

Maintain the required density until the base or pavement is placed on the subgrade.

## **120-8 Backfilling Around Structures and Pipe.**

### **120-8.1 Requirements for all Structures:**

**120-8.1.1 General:** Backfill around structures and pipe in the dry whenever normal dewatering equipment and methods can accomplish the needed dewatering.

**120-8.1.2 Equipment and Methods:** Provide normal dewatering equipment including, but not limited to, surface pumps, sump pumps, wellpoints and header pipe and trenching/digging machinery. Provide normal dewatering methods including, but not limited to, constructing shallow surface drainage trenches/ditches, using sand blankets, perforated pipe drains, sumps and siphons.

**120-8.1.3 Backfill Materials:** Backfill to the original ground surface or subgrade surface of openings made for structures, with a sufficient allowance for settlement. The Engineer may require that the material used for this backfill be obtained from a source entirely apart from the structure.

Do not allow heavy construction equipment to cross over culvert or storm sewer pipes until placing and compacting backfill material to the finished earthwork grade or to an elevation at least 4 feet above the crown of the pipe.

**120-8.1.4 Use of A-7 Material:** In the backfilling of trenches, A-7 material may be used from a point 12 inches above the top of the pipe up to the elevation shown on the FDOT Design Standards as the elevation for undercutting of A-7 material.

**120-8.1.5 Time of Placing Backfill:** Do not place backfill against any masonry or concrete abutment, wingwall, or culvert until the Engineer has given permission to do so, and in no case until the masonry or concrete has been in place seven days or until the specified 28-day compressive strength occurs.

**120-8.1.6 Placement and Compaction:** When the backfill material is deposited in water, compact per 120-8.2.5 and 120-8.3.4. Place the material in horizontal layers not exceeding 6 inches compacted thickness, in depth above water level, behind abutments, wingwalls and end bents or end rest piers, and around box culverts and all structures including pipe culverts. The Engineer may approve placing material in thicker lifts of no more than 12 inches compacted thickness above the soil envelope if a test section demonstrates the required density can be achieved. Approval will be based on five passing density tests over the test section consisting of a lift of backfill from structure to structure. The Engineer will identify the test section with the compaction effort and soil classification in the Agency Logbook. In case of a change in compaction effort or soil classification, construct a new test section. The Engineer reserves the right to terminate the Contractor's use of thick lift construction and have him revert to the 6 inch compacted lifts whenever it is determined that satisfactory results are not being obtained.

### **120-8.2 Additional Requirements for Structures Other than Pipe:**

**120-8.2.1 Density:** Where the backfill material is deposited in water, obtain a 12 inch layer of comparatively dry material, thoroughly compacted by tamping, before the Engineer verifies layer and density requirements. Meet the requirements of the density Acceptance Criteria.

**120-8.2.2 Box Culverts:** For box culverts over which pavement is to be constructed, compact around the structure to an elevation not less than 12 inches above the top of the structure, using rapid-striking mechanical tampers.

**120-8.2.3 Other Limited Areas:** Compact in other limited areas using mechanical tampers or approved hand tampers, until the cover over the structure is at least 12 inches thick. When hand tampers are used, deposit the materials in layers not more than 4 inches thick using hand tampers suitable for this purpose with a face area of not more than 100 in<sup>2</sup>. Take special precautions to prevent any wedging action against the masonry, and step or terrace the slope bounding the excavation for abutments and wingwalls if required by the Engineer.

**120-8.2.4 Culverts and Piers:** Backfill around culverts and piers on both sides simultaneously to approximately the same elevation.

**120-8.2.5 Compaction Under Wet Conditions:** Where wet conditions do not permit the use of mechanical tampers, compact using hand tampers. Use only A-3 material for the hand tamped portions of the backfill. When the backfill has reached an elevation and condition such as to make the use of the mechanical tampers practical, perform mechanical tamping in such manner and to such extent as to transfer the compaction force into the sections previously tamped by hand.

**120-8.3 Additional Requirements for Pipe 15 Inches Inside Diameter or Greater:**

**120-8.3.1 General:** Trenches for pipe may have up to four zones that must be backfilled.

**Lowest Zone:** The lowest zone is backfilled for deep undercuts up to within 4 inches of the bottom of the pipe.

**Bedding Zone:** The zone above the Lowest Zone is the Bedding Zone. Usually it will be the backfill which is the 4 inches of soil below the bottom of the pipe. When rock or other hard material has been removed to place the pipe, the Bedding Zone will be the 12 inches of soil below the bottom of the pipe.

**Cover Zone:** The next zone is backfill that is placed after the pipe has been laid and will be called the Cover Zone. This zone extends to 12 inches above the top of the pipe. The Cover Zone and the Bedding Zone are considered the Soil Envelope for the pipe.

**Top Zone:** The Top Zone extends from 12 inches above the top of the pipe to the base or final grade.

**120-8.3.2 Material:**

**120-8.3.2.1 Lowest Zone:** Backfill areas undercut below the Bedding Zone of a pipe with coarse sand, or other suitable granular material, obtained from the grading operations on the project, or a commercial material if no suitable material is available.

**120-8.3.2.2 Soil Envelope:** In both the Bedding Zone and the Cover Zone of the pipe, backfill with materials classified as A-1, A-2, or A-3. Material classified as A-4 may be used if the pipe is concrete pipe.

**120-8.3.2.3 Top Zone:** Backfill the area of the trench above the soil envelope of the pipe with materials allowed on Design Standard, Index No. 505.

**120-8.3.3 Compaction:**

**120-8.3.3.1 Lowest Zone:** Compact the soil in the Lowest Zone to approximately match the density of the soil in which the trench was cut.

**120-8.3.3.2 Bedding Zone:** If the trench was not undercut below the bottom of the pipe, loosen the soil in the bottom of the trench immediately below the approximate middle third of the outside diameter of the pipe.

If the trench was undercut, place the bedding material and leave it in a loose condition below the middle third of the outside diameter of the pipe. Compact the outer portions to meet the density requirements of the Acceptance Criteria. Place the material in lifts no greater than 6 inches (compacted thickness).

**120-8.3.3.3 Cover Zone:** Place the material in 6 inches layers (compacted thickness), evenly deposited on both sides of the pipe, and compact with mechanical tampers suitable for this purpose. Hand tamp material below the pipe haunch that cannot be reached by mechanical tampers. Meet the requirements of the density Acceptance Criteria.

**120-8.3.3.4 Top Zone:** Place the material in layers not to exceed 12 inches in compacted thickness. Meet the requirements of the density Acceptance Criteria.

**120-8.3.4 Backfill Under Wet Conditions:** Where wet conditions are such that dewatering by normal pumping methods would not be effective, the procedure outlined below may be used when specifically authorized by the Engineer in writing.

Granular material may be used below the elevation at which mechanical tampers would be effective, but only material classified as A-3. Place and compact the material using timbers or hand tampers until the backfill reaches an elevation such that its moisture content will permit the use of mechanical tampers. When the backfill has reached such elevation, use normally acceptable backfill material. Compact the material using mechanical tampers in such manner and to such extent as to transfer the compacting force into the material previously tamped by hand.

## **120-9 Acceptance Program.**

**120-9.1 Density over 105%:** When a computed dry density results in a value greater than 105% of the applicable Proctor maximum dry density, the Engineer will perform a second density test within 5 feet. If the second density results in a value greater than 105%, investigate the compaction methods, examine the applicable Maximum Density and material description. If necessary, the Engineer will test an additional sample for acceptance in accordance with AASHTO T 99, Method C.

**120-9.2 Maximum Density Determination:** The Engineer will determine the maximum density and optimum moisture content by sampling and testing the material in accordance with the specified test method listed in 120-9.3.

**120-9.3 Density Testing Requirements:** Compliance with the requirements of 120-9.5 will be determined in accordance FM 1-T 238. The in-place moisture content will be determined for each density in accordance with FM 5-507 (Determination of Moisture Content by Means of a Calcium Carbide Gas Pressure Moisture Tester), or ASTM D 4643 (Laboratory Determination of Moisture Content of Granular Soils By Use of a Microwave Oven).

**120-9.4 Soil Classification:** The Engineer will perform soil classification tests in accordance with AASHTO T-88, and classify soils in accordance with AASHTO M-145 (Standard Specification for Classification of Soils and Soil-Aggregate Mixtures for Highway Construction Purposes) in order to determine compliance with embankment utilization requirements.

**120-9.5 Acceptance Criteria:** The Engineer will accept a minimum density in accordance with 120-7.2 with the following exceptions:

- 1) embankment constructed by the hydraulic method as specified in 120-6.3;

- 2) material placed outside the standard minimum slope as specified in 120-6.2.4;
- 3) other areas specifically excluded herein.

**120-9.6 Frequency:** The Engineer will conduct sampling and testing at a minimum frequency listed in the table below.

Test Name	Frequency
Maximum Density	One per soil type
Density	1 per 500' RDWY (Alt Lift)
Soil Classification	One per Maximum Density

**120-10 Maintenance and Protection of Work.**

While construction is in progress, maintain adequate drainage for the roadbed at all times. Maintain a shoulder at least 3 feet wide adjacent to all pavement or base construction in order to provide support for the edges.

Maintain and protect all earthwork construction throughout the life of the Contract, and take all reasonable precautions to prevent loss of material from the roadway due to the action of wind or water. Repair any slides, washouts, settlement, subsidence, or other mishap which may occur prior to final acceptance of the work. Maintain all channels excavated as a part of the Contract work against natural shoaling or other encroachments to the lines, grades, and cross-sections shown in the plans, until final acceptance of the project.

**120-11 Construction.**

**120-11.1 Construction Tolerances:** Shape the surface of the earthwork to conform to the lines, grades, and cross-sections shown in the plans. In final shaping of the surface of earthwork, maintain a tolerance of 0.3 foot above or below the plan cross-section with the following exceptions:

1. Shape the surface of shoulders to within 0.1 foot of the plan cross-section.
2. Shape the earthwork to match adjacent pavement, curb, sidewalk, structures, etc.
3. Shape the bottom of ditches so that the ditch impounds no water.
4. When the work does not include construction of base or pavement, shape the entire roadbed (shoulder point to shoulder point) to within 0.1 foot above or below the plan cross-section.

Ensure that the shoulder lines do not vary horizontally more than 0.3 foot from the true lines shown in the plans.

**120-11.2 Operations Adjacent to Pavement:** Carefully dress areas adjacent to pavement areas to avoid damage to such pavement. Complete grassing of shoulder areas prior to placing the final wearing course. Do not manipulate any embankment material on a pavement surface.

When shoulder dressing is underway adjacent to a pavement lane being used to maintain traffic, exercise extreme care to avoid interference with the safe movement of traffic.

**120-12 Method of Measurement.**

**120-12.1 Excavation:** Excavation will be paid for by volume, in cubic yards, calculated by the method of average end areas, unless the Engineer determines that another method of calculation will provide a more accurate result. The material will be measured in its original position by field survey or by photogrammetric means as designated by the Engineer. Measurement for payment will include the excavation of unsuitable material, lateral ditch

excavation, channel excavation, and excavation for structures and pipe. Payment will not be made for excavation or embankment beyond the limits shown in the Plans or authorized by the Engineer.

**120-12.2 Embankment:** Embankment will be paid for in cubic yards, as accepted by Engineer, calculated by the method of average end areas, unless Engineer determines that another method of calculation will provide a more accurate result. Embankment will be measured in its final position by field survey or by photogrammetric means as designated by Engineer.

**120-12.3:** The measurement will include only material actually placed and compacted above the original ground line, within the lines and grades indicated in the Plans or directed by the Engineer. The length used in the computations will be the station-to-station length actually constructed. The original ground line used in the computations will be as determined prior to placing of embankment and no allowance will be made for subsidence of material below the surface of the original ground.

**120-12.4:** Deduct any quantity beyond the limits shown in the Plans or authorized by Engineer. No payment will be made for additional material required to obtain compaction, material placed by Contractor outside the limits of the typical cross section, or material placed to correct for settlement of the embankment. Shrinkage or swell factors are Contractor's responsibility. When shown on the plans, factors are for informational purposes only.

### **120-13 Basis of Payment.**

**120-13.1 General:** Prices and payments for the work items included in this Section will be full compensation for all work described herein, including excavating, dredging, hauling, placing, and compacting; dressing the surface of the earthwork; and maintaining and protecting the complete earthwork and the Articles applicable to the items of work having awarded Contract Prices measured and approved for payment.

**120-13.2 Excavation:** The total quantity of all excavation specified under this Section will be paid for at the Contract unit price for Excavation. No payment will be made for the excavation of any materials which are used for purposes other than those shown in the plans or designated by the Engineer. No payment will be made for materials excavated outside the lines and grades given by the Engineer, unless specifically authorized by the Engineer.

**120-13.3 Embankment:** The total quantity of embankment specified in this Section will be paid for at the Contract unit price for embankment. No payment will be made for materials which are used for purposes other than those shown in the plans or designated by the Engineer. No payment will be made for materials placed outside the lines and grades given by the Engineer.

**120-13.4 When No Direct Payment is Provided:** When no item for Excavation or Embankment is included in the list of Contract Unit Prices, the cost of any excavation or embankment necessary for the proper construction of the Project is included in the Contract Prices for the work requiring excavation or embankment. Where the Work includes structures including pipe culvert and french drain, all earthwork costs for the installation of these items are included in their associated Contract Price.

APPENDIX "D" TO SPECIAL PROVISIONS  
SECTION 334: SUPERPAVE ASPHALT FOR LAP  
(OFF-SYSTEM)

**SUPERPAVE ASPHALT FOR LAP (OFF-SYSTEM).**  
**(REV 1-26-15) (FA 1-29-15)**

**SECTION 334**  
**SUPERPAVE ASPHALT FOR LAP (OFF-SYSTEM)**

**334-1 Description.**

**334-1.1 General:** Construct a Superpave asphalt pavement (consisting of either Hot Mix Asphalt (HMA) or Warm Mix Asphalt (WMA)) based on the type of work specified in the Contract and the Asphalt Work Categories as defined below. Meet the applicable requirements for plants, equipment, and construction requirements as defined below. Use an asphalt mix, either HMA or WMA, which meets the requirements of this specification.

**334-1.2 Asphalt Work Mix Categories:** Construction of asphalt pavement will fall into one of the following work categories:

**334-1.2.1 Asphalt Work Category 1:** Includes the construction of shared use paths and miscellaneous asphalt.

**334-1.2.2 Asphalt Work Category 2:** Includes the construction of new asphalt turn lanes, paved shoulders and other non-mainline pavement locations.

**334-1.2.3 Asphalt Work Category 3:** Includes the construction of new mainline asphalt pavement lanes, milling and resurfacing.

**334-1.3 Mix Types:** Use the appropriate asphalt mix as shown in Table 334-1.

Table 334-1 Asphalt Mix Types			
Asphalt Work Category	Mix Types	Traffic Level	ESALs (millions)
1	Type SP-9.5	A	<0.3
2	Structural Mixes: Types SP-9.5 or SP-12.5 Friction Mixes: Types FC-9.5 or FC-12.5	B	0.3 to <3
3	Structural Mixes: Types SP-9.5 or SP-12.5 Friction Mixes: Types FC-9.5 or FC-12.5	C	≥3

A Type SP or FC mix one traffic level higher than the traffic level specified in the Contract may be substituted, at no additional cost (i.e. Traffic Level B may be substituted for Traffic Level A, etc.). Traffic levels are as defined in Section 334 of the Florida Department of Transportation's (FDOT's) Specifications.

**334-1.4 Gradation Classification:** The Superpave mixes are classified as fine and are defined in 334-3.2.2. The equivalent AASHTO nominal maximum aggregate size Superpave mixes are as follows:

Type SP-9.5, FC-9.5 ..... 9.5 mm



Type SP-12.5, FC-12.5 ..... 12.5 mm

**334-1.5 Thickness:** The total pavement thickness of the asphalt pavement will be based on a specified spread rate or plan thickness as shown in the Contract Documents. Before paving, propose a spread rate or thickness for each individual layer meeting the requirements of this specification, which when combined with other layers (as applicable) will equal the plan spread rate or thickness. When the total pavement thickness is specified as plan thickness, the plan thickness and individual layer thickness will be converted to spread rate using the following equation:

$$\text{Spread rate (lbs/yd}^2\text{)} = t \times G_{\text{mm}} \times 43.3$$

where: t = Thickness (in.) (Plan thickness or individual layer thickness)  
G<sub>mm</sub> = Maximum specific gravity from the mix design

For target purposes only, spread rate calculations shall be rounded to the nearest whole number.

**334-1.5.1 Layer Thicknesses:** Unless otherwise called for in the Contract Documents, the allowable layer thicknesses for asphalt mixtures are as follows:

Type SP-9.5, FC-9.5 ..... 3/4 to 1-1/2 inches

Type SP-12.5, FC-12.5 ..... 1-1/2 to 2-1/2 inches

**334-1.5.2 Additional Requirements:** The following requirements also apply to asphalt mixtures:

1. When construction includes the paving of adjacent shoulders (less than or equal to 5 feet wide), the layer thickness for the upper pavement layer and shoulder shall be the same and paved in a single pass, unless otherwise called for in the Contract Documents.

2. For overbuild layers, use the minimum and maximum layer thicknesses as specified above unless called for differently in the Contract Documents. On variable thickness overbuild layers, the minimum allowable thickness may be reduced by 1/2 inch, and the maximum allowable thickness will be as specified below, unless called for differently in the Contract Documents.

Type SP-9.5..... 3/8 to 2 inches

Type SP-12.5..... 1/2 to 3 inches

3. Variable thickness overbuild layers may be tapered to zero thickness provided the contract documents require a minimum of 1-1/2 inches of mix placed over the variable thickness overbuild layer.

**334-1.6 Weight of Mixture:** The weight of the mixture shall be determined as provided in 320-3.2 of the FDOT Specifications.

**334-2 Materials.**

**334-2.1 Superpave Asphalt Binder:** Unless specified elsewhere in the Contract or in 334-2.3.3, use a PG 67-22 asphalt binder from the FDOT's Approved Products List (APL). If the Contract calls for an alternative asphalt binder, meet the requirements of FDOT Specifications Section 336 or 916, as appropriate.

**334-2.2 Aggregate:** Use aggregate capable of producing a quality pavement.

For Type FC mixes, use an aggregate blend that consists of crushed granite, crushed Oolitic limestone, other crushed materials (as approved by FDOT for friction courses per Rule 14-103.005, Florida Administrative Code), or a combination of the above. Crushed

limestone from the Oolitic formation may be used if it contains a minimum of 12% silica material as determined by FDOT Test Method FM 5-510 and FDOT grants approval of the source prior to its use. As an exception, mixes that contain a minimum of 60% crushed granite may either contain:

1. Up to 40% fine aggregate from other sources; or,
2. A combination of up to 20% RAP and the remaining fine aggregate

from other sources.

A list of aggregates approved for use in friction courses may be available on the FDOT's State Materials Office website. The URL for obtaining this information, if available, is: <ftp://ftp.dot.state.fl.us/fdot/smo/website/sources/frictioncourse.pdf>.

**334-2.3 Reclaimed Asphalt Pavement (RAP) Material:**

**334-2.3.1 General requirements:** RAP may be used as a component of the asphalt mixture, provided the RAP meets the following requirements:

1. When using a PG 76-22 (PMA), or PG 76-22 (ARB) asphalt binder, limit the amount of RAP material used in the mix to a maximum of 20% by weight of total aggregate. As an exception, amounts greater than 20% RAP by weight of total aggregate can be used if no more than 20% by weight of total asphalt binder comes from the RAP material.
2. Provide stockpiled RAP material that is reasonably consistent in characteristics and contains no aggregate particles which are soft or conglomerates of fines.
3. Provide RAP material having a minimum average asphalt binder content of 4.0% by weight of RAP. As an exception, when using fractionated RAP, the minimum average asphalt binder content for the coarse portion of the RAP shall be 2.5% by weight of the coarse portion of the RAP. The coarse portion of the RAP shall be the portion of the RAP retained on the No. 4 sieve. The Engineer may sample the stockpile to verify that this requirement is met.
4. Use a grizzly or grid over the RAP cold bin, in-line roller crusher, screen, or other suitable means to prevent oversized RAP material from showing up in the completed recycle mixture. If oversized RAP material appears in the completed recycle mix, take the appropriate corrective action immediately. If the appropriate corrective actions are not immediately taken, stop plant operations.

**334-2.3.2 Material Characterization:** Assume responsibility for establishing the asphalt binder content, gradation, and bulk specific gravity ( $G_{sb}$ ) of the RAP material based on a representative sampling of the material.

**334-2.3.3 Asphalt Binder for Mixes with RAP:** Select the appropriate asphalt binder grade based on Table 334-2. The Engineer reserves the right to change the asphalt binder type and grade during production based on characteristics of the RAP asphalt binder.

Table 334-2 Asphalt Binder Grade for Mixes Containing RAP	
Percent RAP	Asphalt Binder Grade
0 - 15	PG 67-22
16 - 30	PG 58-22
> 30	PG 52-28

### 334-3 Composition of Mixture.

**334-3.1 General:** Compose the asphalt mixture using a combination of aggregates, mineral filler, if required, and asphalt binder material. Size, grade and combine the aggregate fractions to meet the grading and physical properties of the mix design. Aggregates from various sources may be combined.

#### 334-3.2 Mix Design:

**334-3.2.1 General:** Design the asphalt mixture in accordance with AASHTO R 35-12, except as noted herein. Submit the proposed mix design with supporting test data indicating compliance with all mix design criteria to the Engineer. Prior to the production of any asphalt mixture, obtain the Engineer's conditional approval of the mix design. If required by the Engineer, send representative samples of all component materials, including asphalt binder to a laboratory designated by the Engineer for verification. As an exception to these requirements, use a currently approved FDOT Mix Design.

Warm mix technologies (additives, foaming techniques, etc.) listed on the Department's website may be used in the production of the mix. The URL for obtaining this information, is:

<http://www.dot.state.fl.us/statematerialsoffice/quality/programs/warmmixasphalt/index.shtm>.

The Engineer will consider any marked variations from original test data for a mix design or any evidence of inadequate field performance of a mix design as sufficient evidence that the properties of the mix design have changed, and at his discretion, the Engineer may no longer allow the use of the mix design.

**334-3.2.2 Mixture Gradation Requirements:** Combine the aggregates in proportions that will produce an asphalt mixture meeting all of the requirements defined in this specification and conform to the gradation requirements at design as defined in AASHTO M 323-12, Table 3. Aggregates from various sources may be combined.

**334-3.2.2.1 Mixture Gradation Classification:** Plot the combined mixture gradation on an FHWA 0.45 Power Gradation Chart. Include the Control Points from AASHTO M323-12, Table-3, as well as the Primary Control Sieve (PCS) Control Point from AASHTO M323-12, Table 4. Fine mixes are defined as having a gradation that passes above or through the primary control sieve control point.

**334-3.2.3 Gyratory Compaction:** Compact the design mixture in accordance with AASHTO T312-12, with the following exceptions: use the number of gyrations at  $N_{\text{design}}$  as designed in Table 334-3.

Traffic Level	$N_{\text{design}}$ Number of Gyrations
A	50
B	65
C	75

**334-3.2.4 Design Criteria:** Meet the requirements for nominal maximum aggregate size as defined in AASHTO M323-12, as well as for relative density, VMA, VFA, and dust-to-binder ratio as specified in AASHTO M323-12, Table 6.  $N_{\text{initial}}$  and  $N_{\text{maximum}}$  requirements are not applicable.

**334-3.2.5 Moisture Susceptibility:** Test 4 inch specimens in accordance with FDOT Test Method FM 1-T 283. Provide a mixture having a retained tensile strength ratio of at least 0.80 and a minimum tensile strength (unconditioned) of 100 pounds per square inch. If necessary, add a liquid anti-stripping agent from the FDOT's APL or hydrated lime in order to meet these criteria.

In lieu of moisture susceptibility testing, add a liquid anti-stripping agent from the FDOT's APL. Add 0.5% liquid anti-stripping agent by weight of asphalt binder.

**334-3.2.6 Additional Information:** In addition to the requirements listed above, provide the following information on each mix design:

1. The design traffic level and the design number of gyrations ( $N_{\text{design}}$ ).
2. The source and description of the materials to be used.
3. The FDOT source number and the FDOT product code of the aggregate components furnished from an FDOT approved source (if required).
4. The gradation and proportions of the raw materials as intended to be combined in the paving mixture. The gradation of the component materials shall be representative of the material at the time of use. Compensate for any change in aggregate gradation caused by handling and processing as necessary.
5. A single percentage of the combined mineral aggregate passing each specified sieve. Degradation of the aggregate due to processing (particularly material passing the No. 200 sieve) should be accounted for and identified.
6. The bulk specific gravity ( $G_{\text{sb}}$ ) value for each individual aggregate and RAP component.
7. A single percentage of asphalt binder by weight of total mix intended to be incorporated in the completed mixture, shown to the nearest 0.1%.
8. A target temperature for the mixture at the plant (mixing temperature) and a target temperature for the mixture at the roadway (compaction temperature). Do not exceed a target temperature of 330°F for PG 76-22 (PMA) and PG 76-22 (ARB) asphalt binders, and 315°F for unmodified asphalt binders.
9. Provide the physical properties achieved at four different asphalt binder contents. One shall be at the optimum asphalt content, and must conform to all specified physical requirements.
10. The name of the mix designer.
11. The ignition oven calibration factor.
12. The warm mix technology, if used.

#### **334-4 Process Control.**

Assume full responsibility for controlling all operations and processes such that the requirements of these Specifications are met at all times. Perform any tests necessary at the plant and roadway to control the process.

#### **334-5 General Construction Requirements.**

**334-5.1 Weather Limitations:** Do not transport asphalt mix from the plant to the roadway unless all weather conditions are suitable for the paving operations.

##### **334-5.2 Limitations of Paving Operations:**

**334-5.2.1 General:** Spread the mixture only when the surface upon which it is to be placed has been previously prepared, is intact, firm, dry, clean, and the tack, with acceptable

spread rate, is properly broken. Ensure all granular base materials are properly primed and all asphalt base materials are properly tacked, prior to paving.

<b>334-5.2.2 Air Temperature:</b> Place the mixture only when the air temperature in the shade and away from the artificial heat meets the requirements of Table 334-4. The minimum ambient temperature requirement may be reduced by 5°F when using a warm mix technology, if mutually agreed to by both the Engineer and the Contractor. Table 334-4 Ambient Air Temperature Requirements for Paving	
Layer Thickness or Asphalt Binder Type	Minimum Temperature (°F)
≤1 inch	50
Any mixture > 1 inch containing a PG asphalt binder with a high temperature designation ≥ 76°C	45
Any mixture > 1 inch containing a PG asphalt binder with a high temperature designation < 76°C	40

**334-5.3 Mix Temperature:** Heat and combine the ingredients of the mix in such a manner as to produce a mixture with a temperature at the plant and at the roadway, within a range of plus or minus 30°F from the target temperature as shown on the mix design. Reject all loads outside of this range. For warm mix asphalt, the Contractor may produce the first five loads of the production day and at other times when approved by the Engineer, at a hot mix asphalt temperature not to exceed 330°F for purposes of heating the asphalt paver. For these situations, the upper tolerance of +30°F does not apply.

**334-5.4 Transportation of the Mixture:** Transport the mix in trucks of tight construction, which prevents the loss of material and the excessive loss of heat and previously cleaned of all foreign material. After cleaning, thinly coat the inside surface of the truck bodies with soapy water or an asphalt release agent as needed to prevent the mixture from adhering to the beds. Do not allow excess liquid to pond in the truck body. Do not use a release agent that will contaminate, degrade, or alter the characteristics of the asphalt mix or is hazardous or detrimental to the environment. Petroleum derivatives (such as diesel fuel), solvents, and any product that dissolves asphalt are prohibited. Provide each truck with a tarpaulin or other waterproof cover mounted in such a manner that it can cover the entire load when required. When in place, overlap the waterproof cover on all sides so it can be tied down. Cover each load during cool and cloudy weather and at any time it appears rain is likely during transit with a tarpaulin or waterproof cover. Cover and tie down all loads of friction course mixtures.

**334-5.5 Preparation of Surfaces Prior to Paving:**

**334-5.5.1 Cleaning:** Clean the surface of all loose and deleterious material by the use of power brooms or blowers, supplemented by hand brooming where necessary.

**334-5.5.2 Patching and Leveling Courses:** As shown in the plans, bring the existing surface to proper grade and cross-section by the application of patching or leveling courses.

**334-5.5.3 Application over Surface Treatment:** Where an asphalt mix is to be placed over a surface treatment, sweep and dispose of all loose material from the paving area.

**334-5.5.4 Tack Coat:** Use a rate of application as defined in Table 334-5. Control the rate of application to be within plus or minus 0.01 gallon per square yard of the target application rate. The target application rate may be adjusted by the Engineer to meet specific field conditions. Determine the rate of application as needed to control the operation. When using PG 52-28, multiply the target rate of application by 0.6.

Table 334-5 Tack Coat Application Rates		
Asphalt Mixture Type	Underlying Pavement Surface	Target Tack Rate (gal/yd <sup>2</sup> )
Base Course, Structural Course, Dense Graded Friction Course	Newly Constructed Asphalt Layers	0.03 minimum
	Milled Surface or Oxidized and Cracked Pavement	0.06
	Concrete Pavement	0.08

### 334-5.6 Placing Mixture:

**334-5.6.1 Alignment of Edges:** With the exception of pavements placed adjacent to curb and gutter or other true edges, place all pavements by the stringline method to obtain an accurate, uniform alignment of the pavement edge. Control the unsupported pavement edge to ensure that it will not deviate more than plus or minus 1.5 inches from the stringline.

**334-5.6.2 Rain and Surface Conditions:** Immediately cease transportation of asphalt mixtures from the plant when rain begins at the roadway. Do not place asphalt mixtures while rain is falling, or when there is water on the surface to be covered. Once the rain has stopped and water has been removed from the tacked surface to the satisfaction of the Engineer and the temperature of the mixture caught in transit still meets the requirements as specified in 334-5.3, the Contractor may then place the mixture caught in transit.

**334-5.6.3 Checking Depth of Layer:** Check the depth of each layer at frequent intervals to ensure a uniform spread rate that will meet the requirements of the Contract.

**334-5.6.4 Hand Work:** In limited areas where the use of the spreader is impossible or impracticable, spread and finish the mixture by hand.

**334-5.6.5 Spreading and Finishing:** Upon arrival, dump the mixture in the approved paver, and immediately spread and strike-off the mixture to the full width required, and to such loose depth for each course that, when the work is completed, the required weight of mixture per square yard, or the specified thickness, is secured. Carry a uniform amount of mixture ahead of the screed at all times.

**334-5.6.6 Thickness Control:** Ensure the spread rate is within 10% of the target spread rate, as indicated in the Contract. When calculating the spread rate, use, at a minimum, an average of five truckloads of mix. When the average spread rate is beyond plus or minus 10% of the target spread rate, monitor the thickness of the pavement layer closely and adjust the construction operations.

If the Contractor fails to maintain an average spread rate within plus or minus 10% of the target spread rate for two consecutive days, the Engineer may elect to stop the construction operation at any time until the issue is resolved.

When the average spread rate for the total structural or friction course pavement thickness exceeds the target spread rate by plus or minus 50 pounds per square yard for layers greater than or equal to 2.5 inches or exceeds the target spread rate by plus or minus 25 pounds per square yard for layers less than 2.5 inches, address the unacceptable pavement in accordance with 334-5.10.4, unless an alternative approach is agreed upon by the Engineer.

### **334-5.7 Leveling Courses:**

**334-5.7.1 Patching Depressions:** Before spreading any leveling course, fill all depressions in the existing surface as shown in the plans.

**334-5.7.2 Spreading Leveling Courses:** Place all courses of leveling with an asphalt paver or by the use of two motor graders, one being equipped with a spreader box. Other types of leveling devices may be used upon approval by the Engineer.

**334-5.7.3 Rate of Application:** When using Type SP-9.5 for leveling, do not allow the average spread of a layer to be less than 50 pounds per square yard or more than 75 pounds per square yard. The quantity of mix for leveling shown in the plans represents the average for the entire project; however, the Contractor may vary the rate of application throughout the project as directed by the Engineer. When leveling in connection with base widening, the Engineer may require placing all the leveling mix prior to the widening operation.

**334-5.8 Compaction:** For each paving or leveling train in operation, furnish a separate set of rollers, with their operators.

When density testing for acceptance is required, select equipment, sequence, and coverage of rolling to meet the specified density requirement. Regardless of the rolling procedure used, complete the final rolling before the surface temperature of the pavement drops to the extent that effective compaction may not be achieved or the rollers begin to damage the pavement.

When density testing for acceptance is not required, use a rolling pattern approved by the Engineer.

Use hand tamps or other satisfactory means to compact areas which are inaccessible to a roller, such as areas adjacent to curbs, headers, gutters, bridges, manholes, etc.

### **334-5.9 Joints.**

**334-5.9.1 Transverse Joints:** Construct smooth transverse joints, which are within 3/16 inch of a true longitudinal profile when measured with a 15 foot manual straightedge meeting the requirements of FDOT Test Method FM 5-509. These requirements are waived for transverse joints at the beginning and end of the project and at the beginning and end of bridge structures, if the deficiencies are caused by factors beyond the control of the Contractor such as no milling requirement, as determined by the Engineer. When smoothness requirements are waived, construct a reasonably smooth transitional joint.

**334-5.9.2 Longitudinal Joints:** For all layers of pavement except the leveling course, place each layer so that longitudinal construction joints are offset 6 to 12 inches laterally between successive layers. Do not construct longitudinal joints in the wheel paths. The Engineer may waive these requirements where offsetting is not feasible due to the sequence of construction.

**334-5.10 Surface Requirements:** Construct a smooth pavement with good surface texture and the proper cross slope.

**334-5.10.1 Texture of the Finished Surface of Paving Layers:** Produce a finished surface of uniform texture and compaction with no pulled, torn, raveled, crushed or loosened portions and free of segregation, bleeding, flushing, sand streaks, sand spots, or ripples. Correct any area of the surface that does not meet the foregoing requirements in accordance with 334-5.10.4.

In areas not defined to be a density testing exception per 334-6.4.1, obtain for the Engineer, three 6 inch diameter roadway cores at locations visually identified by the Engineer to be segregated. The Engineer will determine the density of each core in accordance with FDOT

Test Method FM 1-T 166 and calculate the percent  $G_{mm}$  of the segregated area using the average  $G_{mb}$  of the roadway cores and the representative PC  $G_{mm}$  for the questionable material. If the average percent  $G_{mm}$  is less than 90.0, address the segregated area in accordance with 334-5.10.4.

**334-5.10.2 Cross Slope:** Construct a pavement surface with cross slopes in compliance with the requirements of the Contract Documents.

**334-5.10.3 Pavement Smoothness:** Construct a smooth pavement meeting the requirements of this Specification. Furnish a 15 foot manual and a 15 foot rolling straightedge meeting the requirements of FDOT Test Method FM 5-509.

**334-5.10.3.1 Straightedge Testing:**

**334-5.10.3.1.1 Acceptance Testing:** Perform straightedge testing in the outside wheel path of each lane for the final (top) layer of the pavement. Test all pavement lanes where the width is constant using a rolling straightedge and document all deficiencies on a form approved by the Engineer. Notify the Engineer of the location and time of all straightedge testing a minimum of 48 hours before beginning testing.

**334-5.10.3.1.2 Final (Top) Pavement Layer:** At the completion of all paving operations, straightedge the final (top) layer either behind the final roller of the paving train or as a separate operation. Address all deficiencies in excess of 3/16 inch in accordance with 334-5.10.4, unless waived by the Engineer. Retest all corrected areas.

**334-5.10.3.1.3 Straightedge Exceptions:** Straightedge testing will not be required in the following areas: shoulders, intersections, tapers, crossovers, sidewalks, shared use paths, parking lots and similar areas, or in the following areas when they are less than 250 feet in length: turn lanes, acceleration/deceleration lanes and side streets. The limits of the intersection will be from stop bar to stop bar for both the mainline and side streets. In the event the Engineer identifies a surface irregularity in the above areas that is determined to be objectionable, straightedge and address all deficiencies in excess of 3/8 inch in accordance with 334-5.10.4.

**334-5.10.4 Correcting Unacceptable Pavement:** Correct deficiencies in the pavement layer by removing and replacing the full depth of the layer, extending a minimum of 50 feet on both sides (where possible) of the defective area for the full width of the paving lane, at no additional cost.

**334-6 Acceptance of the Mixture.**

**334-6.1 General:** The asphalt mixture will be accepted based on the Asphalt Work Category as defined below:

1. Asphalt Work Category 1 – Certification by the Contractor as defined in 334-6.2.

2. Asphalt Work Category 2 – Certification and process control testing by the Contractor as defined in 334-6.3.

3. Asphalt Work Category 3 – Process control testing by the Contractor and acceptance testing by the Engineer as defined in 334-6.4.

**334-6.2 Certification by the Contractor:** On Asphalt Work Category 1 construction, the Engineer will accept the mix on the basis of visual inspection. Submit a Notarized Certification of Specification Compliance letter on company letterhead to the Engineer stating that all material produced and placed on the project meets the requirements of the Specifications. The Engineer may run independent tests to determine the acceptability of the material.



**334-6.3 Certification and Process Control Testing by the Contractor:** On Asphalt Work Category 2 construction, submit a Notarized Certification of Specification Compliance letter on company letterhead to the Engineer stating that all material produced and placed on the project meets the requirements of the Specifications, along with supporting test data documenting all process control testing as described in 334-6.3.1. If required by the Contract, utilize an Independent Laboratory as approved by the Engineer for the process control testing. The mix will also require visual acceptance by the Engineer. In addition, the Engineer may run independent tests to determine the acceptability of the material. Material failing to meet these acceptance criteria will be addressed as directed by the Engineer such as but not limited to acceptance at reduced pay, delineation testing to determine the limits of the questionable material, removal and replacement at no cost to the agency, or performing an Engineering analysis to determine the final disposition of the material.

**334-6.3.1 Process Control Sampling and Testing Requirements:** Perform process control testing at a frequency of once per day. Obtain the samples in accordance with FDOT Method FM 1-T 168. Test the mixture at the plant for gradation (P<sub>.8</sub> and P<sub>.200</sub>) and asphalt binder content (P<sub>b</sub>). Measure the roadway density with 6 inch diameter roadway cores at a minimum frequency of once per 1,500 feet of pavement with a minimum of three cores per day.

Determine the asphalt binder content of the mixture in accordance with FDOT Method FM 5-563. Determine the gradation of the recovered aggregate in accordance with FDOT Method FM 1-T 030. Determine the roadway density in accordance with FDOT Method FM 1-T 166. The minimum roadway density will be based on the percent of the maximum specific gravity (G<sub>mm</sub>) from the approved mix design. If the Contractor or Engineer suspects that the mix design G<sub>mm</sub> is no longer representative of the asphalt mixture being produced, then a new G<sub>mm</sub> value will be determined from plant-produced mix, in accordance with FDOT Method FM 1-T 209, with the approval of the Engineer. Roadway density testing will not be required in certain situations as described in 334-6.4.1. Assure that the asphalt binder content, gradation and density test results meet the criteria in Table 334-4.

Table 334-4 Process Control and Acceptance Values	
Characteristic	Tolerance
Asphalt Binder Content (percent)	Target ± 0.55
Passing No. 8 Sieve (percent)	Target ± 6.00
Passing No. 200 Sieve (percent)	Target ± 2.00
Roadway Density (daily average)	Minimum 90.0% of G <sub>mm</sub>

**334-6.4 Process Control Testing by the Contractor and Acceptance Testing by the Engineer:** On Asphalt Work Category 3, perform process control testing as described in 334-6.3.1. In addition, the Engineer will accept the mixture at the plant with respect to gradation (P<sub>.8</sub> and P<sub>.200</sub>) and asphalt binder content (P<sub>b</sub>). The mixture will be accepted on the roadway with respect to density. The Engineer will sample and test the material as described in 334-6.3.1. The Engineer will randomly obtain at least one set of samples per day. Assure that the asphalt content, gradation and density test results meet the criteria in Table 334-4. Material failing to meet these acceptance criteria will be addressed as directed by the Engineer such as but not limited to acceptance at reduced pay, delineation testing to determine the limits of the

questionable material, removal and replacement at no cost to the agency, or performing an Engineering analysis to determine the final disposition of the material.

**334-6.4.1 Acceptance Testing Exceptions:** When the total quantity of any mix type in the project is less than 500 tons, the Engineer will accept the mix on the basis of visual inspection. The Engineer may run independent tests to determine the acceptability of the material.

Density testing for acceptance will not be performed on widening strips or shoulders with a width of 5 feet or less, variable thickness overbuild courses, leveling courses, any asphalt layer placed on subgrade (regardless of type), miscellaneous asphalt pavement, shared use paths, crossovers, or any course with a specified thickness less than 1 inch or a specified spread rate less than 100 pounds per square yard. Density testing for acceptance will not be performed on asphalt courses placed on bridge decks or approach slabs; compact these courses in static mode only. In addition, density testing for acceptance will not be performed on the following areas when they are less than 1,000 feet continuous in length: turning lanes, acceleration lanes, deceleration lanes, shoulders, parallel parking lanes, or ramps. Density testing for acceptance will not be performed in intersections. The limits of the intersection will be from stop bar to stop bar for both the mainline and side streets. Compact these courses in accordance with a standard rolling procedure approved by the Engineer. In the event that the rolling procedure deviates from the approved procedure, placement of the mix will be stopped.

#### **334-7 Method of Measurement.**

For the work specified under this Section, the quantity to be paid for will be the weight of the mixture, in tons.

The bid price for the asphalt mix will include the cost of the liquid asphalt and the tack coat application as specified in 334-5.5.4. There will be no separate payment or unit price adjustment for the asphalt binder material in the asphalt mix.

#### **334-8 Basis of Payment.**

Prices and payments will be full compensation for all work and materials specified in this Article and the Articles applicable to the items of work having awarded Contract Prices measured and approved for payment.

APPENDIX "E" TO SPECIAL PROVISIONS  
SECTION 344: CONCRETE FOR LAP  
(OFF-SYSTEM)

## CONCRETE FOR LAP (OFF-SYSTEM).

(REV 12-20-11) (FA 2-27-12)

### SECTION 344 CONCRETE FOR LAP (OFF-SYSTEM)

#### 344-1 Description.

**344-1 General:** Construct concrete based on the type of work as described in the Contract and the concrete work categories as defined below.

**344-1.2 Work Categories:** Construction will fall into one of the following concrete work categories:

**344-1.2.1 Concrete Work Category 1:** Includes the construction of sidewalks, curb and gutter, ditch and slope pavement, or other non-reinforced cast-in-place elements.

**344-1.2.2 Concrete Work Category 2:** Includes the construction of precast concrete including concrete barriers, traffic railing barriers, parapets, sound barriers, inlets, manholes, junction boxes, pipe culverts, storm sewers, box culverts, prestressed concrete poles, concrete bases for light poles, highway sign foundations, retaining wall systems, traffic separators or other structural precast elements.

**344-1.2.3 Concrete Work Category 3:** Includes the work associated with the placement and/or construction of structural cast-in-place concrete meeting the requirements of this section.

#### 344-2 Materials.

**344-2.1 General:** Use concrete composed of a mixture of Portland cement, aggregates, and water, with or without chemical or mineral admixtures that meet the following requirements:

**344-2.1.1 Portland Cement:** Portland cements meeting the requirements of AASHTO M-85 or ASTM C-150 is required. Different brands of cement, cement of the same brand from different facilities or different types of cement shall be stored separately and shall not be mixed.

**344-2.1.2 Coarse and Fine Aggregates:** Aggregates shall meet ASTM C 33. Source approval by the FDOT is not required.

**344-2.1.3 Water:** Water shall meet the requirements of ASTM C 1602.

**344-2.1.4 Chemical Admixtures:** Chemical admixtures shall be listed on the FDOT Qualified Products List. Admixtures may be added at the dosage rates recommended by the manufacturer.

**344-2.1.5 Pozzolans and Slag:** Pozzolans and Slag shall meet the requirements of Table 344-1. Fly ash shall not include the residue resulting from the burning of municipal garbage or any other refuse with coal, or the burning of industrial or municipal garbage in incinerators.

Type or Class	Test Method	Exceptions
Class C Fly Ash	ASTM C 618	Not to be used with Types IP or IS cements.
Class F Fly Ash	ASTM C 618	Not to be used with Types IP or IS cements.
Petroleum Coke Class F	ASTM C 618	Not to be used with Types IP or IS cements.

Bark Ash Class F	ASTM C 618	Not to be used with Types IP or IS cements.
Silica Fume	ASTM C 1240	
Metakaolin	ASTM C 618	
Slag	ASTM C 989	Use only ground granulated blast-furnace slag grade 100 or 120.
Ultra Fine Fly Ash	ASTM C 618	Not to be used with Types IP or IS cements.

### 344-3 Production, Mixing and Delivery of Concrete.

#### 344-3.1 Concrete Production Requirements:

**344-3.1.1 Category 1:** Use a concrete production facility that is certified by the National Ready Mixed Concrete Association (NRMCA) or listed on the FDOT list of non-structural concrete producers. Concrete production facilities listed on the FDOT Producers with Accepted QC Programs list for structural concrete may also be used for Category 1.

**344-3.1.2 Category 2:** Use a prestressed and or precast facility listed on the FDOT Producers with Accepted QC Programs for precast or prestressed concrete.

**344-3.1.3 Category 3:** Use a structural concrete facility listed on the FDOT Producers with Accepted QC Programs for structural concrete.

#### 344-3.2 Classes of Concrete: Meet the requirements of Table 344-2.

Table 344-2						
Class	Minimum Strength (28 day) (psi)	Target Slump (inches)	Target Range (inches)	Air Content Range (%)	Minimum Total Cementitious Materials Content (lb/yd <sup>3</sup> )	Maximum Water to Cementitious Material Ratio (lb/lb)
Category 1						
Class NS	2,500	N/A	N/A	N/A	N/A	N/A
Category 3						
I	3,000	3	± 1.5	1.0 to 6.0	470	0.53
I (Pavement)	3,000	2	± 1.5	1.0 to 6.0	470	0.50
II	3,400	3	± 1.5	1.0 to 6.0	470	0.53
II (Bridge Deck)	4,500	3	± 1.5	1.0 to 6.0	611	0.44
III	5,000	3	± 1.5	1.0 to 6.0	611	0.44
III (Seal)	3,000	8	± 1.5	1.0 to 6.0	611	0.53
IV	5,500	3	± 1.5	1.0 to 6.0	658	0.41
IV (Drilled Shaft)	4,000	8.5	± 1.5	0.0 to 6.0	658	0.41
V (Special)	6,000	3	± 1.5	1.0 to 6.0	752	0.37
V	6,500	3	± 1.5	1.0 to 6.0	752	0.37
VI	8,500	3	± 1.5	1.0 to 6.0	752	0.37

**344-3.3 Contractors Quality Control:** For Categories 1 and 2, assume full responsibility for controlling all operations and processes such that the requirements of these Specifications are met at all times.

For Category 3, furnish a Quality Control (QC) plan to identify to the Engineer how quality will be ensured at the project site. During random inspections, the Engineer will use this document to verify that the construction of the project is in agreement with the QC plan.

**344-3.4 Concrete Mix Design:** Before producing any Category 1 or Category 2, submit the proposed mix designs to the Engineer on a form provided by the Engineer. For Category 3, submit to the Engineer for approval, FDOT approved mix designs. Do not use concrete mix designs without prior approval of the Engineer.

Materials may be adjusted provided that the theoretical yield requirement of the approved mix design is met. Show all required original approved design mix data and batch adjustments on an Engineer approved concrete delivery ticket.

**344-3.5 Delivery:** For Category 3, the maximum allowable transit time of concrete is 90 minutes.

Furnish a delivery ticket on a form approved by the Engineer with each batch of concrete before unloading at the placement site. Record material quantities incorporated into the mix on the delivery ticket. Ensure that the Batchers responsible for producing the concrete signs the delivery ticket certifying that the batch was produced and delivered in accordance with these requirements. Sign the delivery ticket certifying that the concrete was placed in accordance with these requirements.

**344-3.6 Placing Concrete:**

**344-3.6.1 Concreting in Cold Weather:** Do not mix or place concrete when the air temperature at placement is below 45°F.

During the curing period, if NOAA predicts the ambient temperature to fall below 35°F for 12 hours or more or to fall below 30°F for more than 4 hours, enclose the structure in such a way that the air temperature within the enclosure can be kept above 50°F for a period of 3 days after placing the concrete or until the concrete reaches a minimum compressive strength of 1,500 psi.

Assume all risks connected with the placing and curing of concrete. Although the Engineer may give permission to place concrete, the Contractor is responsible for satisfactory results. If the placed concrete is determined to be unsatisfactory, remove, dispose of, and replace the concrete at no expense to the Agency.

**344-3.6.2 Concreting in Hot Weather:** For Category 3, hot weather concreting is defined as the production, placing and curing of concrete when the concrete temperature at placing exceeds 86°F but is less than 100°F.

Unless the specified hot weather concreting measures are in effect, reject concrete exceeding 86°F at the time of placement. Regardless of special measures taken, reject concrete exceeding 100°F. Predict the concrete temperatures at placement time and implement hot weather measures to avoid production shutdown.

**344-3.7 Mixers:** For Category 3 concrete, do not place concrete from a truck mixer that does not have a current FDOT mixer identification card.

**344-3.8 Small Quantities of Concrete:** With approval of the Engineer, small quantities of concrete, less than 3 cubic yards placed in one day and less than 0.5 cubic yards placed in a single placement may be accepted using a pre-bagged mixture. The Engineer may verify that the pre-bagged mixture is prepared in accordance with the manufacturer's recommendations and will meet the requirements of this Specification.

**344-3.9 Sampling and Testing:**

**344-3.9.1 Category 1:** The Engineer may sample and test the concrete to verify its quality. The minimum 28 day compressive strength requirement for this concrete is 2,500 psi.

**344-3.9.2: Category 2:** No sampling and testing is required for category 2.

**344-3.9.3 Category 3:** The Engineer will randomly select a sample from each 200 cubic yards or one day's production to determine plastic properties and to make three 4 x 8 inch cylinders for testing by the Engineer at 28 days to ensure that the design compressive strength has been met for the class of concrete as specified in Table 344-2.

**344-3.10 Records:** Ensure the following records are available for review for at least 3 years after final acceptance of the project:

1. Approved concrete mix designs.
2. Materials source (delivery tickets, certifications, certified mill test reports).
3. A copy of the scale company or testing agency report showing the observed deviations from quantities checked during calibration of the scales and meters.
4. A copy of the documentation certifying the admixture weighing/measuring devices.

#### **344-4 Acceptance of the Work.**

**344-4.1 Category 1 Work:** Category 1 work will be accepted based on certification by the batcher and contractor on the delivery ticket.

**344-4.2 Category 2 Work:** Certify that the precast elements were produced by a production facility on the FDOT's list of Producers with Accepted QC Programs for precast or prestressed concrete. In addition, the producer's logo shall be stamped on the element. The producer shall not use the Florida Department of Transportation QC stamp on elements used on this project. Provide a statement of certification from the manufacturer of the precast element that the element meets the requirements of this Specification.

**344-4.3 Category 3 Work:** Category 3 concrete will be accepted based on the Engineer's test results for plastic properties and compressive strength requirements for the class of concrete as defined in Table 344-2. In addition, a Delivery Ticket as described in 344-3.5 will be required for acceptance of the material at the project site.

**344-4.4 Small Quantities of Concrete:** Category 3 concrete meeting the definition of 344-3.8 will be accepted in accordance with 344-4.3 based on test results for plastic properties and compressive strength.

#### **344-5 Method of Measurement.**

The quantities to be paid for will be the concrete items having awarded Contract Prices that are completed and accepted by Engineer.

#### **344-6 Basis of Payment.**

Prices and payments will be full compensation for all work and materials specified in this Article and the Articles applicable to the items of work having awarded Contract Prices measured and approved for payment.

APPENDIX "F" TO SPECIAL PROVISIONS  
SECTION 580: LANDSCAPE INSTALLATION FOR LAP  
(OFF-SYSTEM)



**LANDSCAPE INSTALLATION FOR LAP (OFF-SYSTEM).**  
**(REV 4-5-11) (FA 4-15-11)**

**SECTION 580**  
**LANDSCAPE INSTALLATION FOR LAP (OFF-SYSTEM)**

**580-1 Description.**

Plant trees and shrubs of the species, size, and quality indicated in the plans.

The Engineer reserves the right to adjust the number and location of any of the designated types and species to be used at any of the locations shown, in order to provide for any unanticipated effects which might become apparent after the substantial completion of other phases of the project, or for other causes.

**580-2 Materials.**

**580-2.1 Plants:**

**580-2.1.1 Authority for Nomenclature; Species, etc.:** For the designated authority in the identification of all plant material, refer to two publications of L.H. Bailey: "Hortus III" and "Manual of Cultivated Plants," and ensure that all specimens are true to type, name, etc., as described therein. For the standard nomenclature, refer to the publication of the American Joint Committee on Horticultural Nomenclature, "Standardized Plant Names."

**580-2.1.2 Grade Standards and Conformity with Type and Species:** Only use nursery grown plant material except where specified as Collected Material. Use nursery grown plant material that complies with all required inspection, grading standards, and plant regulations in accordance with the latest edition of the Florida Department of Agriculture's "Grades and Standards for Nursery Plants".

Except where a lesser grade might be specifically specified in the plans, ensure that the minimum grade for all trees and shrubs is Florida No. 1. Ensure that all plants are the proper size and grade at the time of delivery to the site, throughout the project construction period and during any designated plant establishment period.

Ensure that plant materials are true to type and species and that any plant materials not specifically covered in Florida Department of Agriculture's "Grades and Standards for Nursery Plants" conform in type and species with the standards and designations in general acceptance by Florida nurseries.

Ensure that plant materials are shipped with tags stating the botanical and common name of the plant.

**580-2.1.3 Inspection and Transporting:** Move nursery stock in accordance with all Federal and State regulations therefor, and accompany each shipment with the required inspection certificates for filing with the Engineer.

**580-2.2 Water:** Water used in landscaping operations may be obtained from any approved source. Ensure that water is free of any substance which might be detrimental to plant growth. The use of effluent water is subject to approval and must meet all Federal, State and Local requirements.

### **580-3 Specific Requirements for the Various Plant Designations.**

#### **580-3.1 Balled-and-Burlapped Plants (B&B), and Wired Balled-and-Burlapped (WB & B):**

**580-3.1.1 General:** Properly protect the root ball of these plants until planting them. The Engineer may reject any plant which shows evidence of having been mishandled.

Set the B&B and WB&B plants then remove the top 2/3 of all wire, rope, and binding surrounding the plant. Remove the burlap from the top 4 inches of the root ball. Do not disturb the root ball in any way. Bare root material is not allowed for substitution.

At least 90 days before digging out B & B and WB & B plants, root-prune those 1 1/2 inches or greater in diameter and certify such fact on accompanying invoices.

**580-3.1.2 Provisions for Wiring:** For plants grown in soil of a loose texture, which does not readily adhere to the root system (and especially in the case of large plants or trees), the Engineer may require WB & B plants. For WB & B plants, before removing the plant from the excavated hole, place sound hog wire around the burlapped ball, and loop and tension it until the tightened wire netting substantially packages the burlapped ball such as to prevent disturbing of the loose soil around the roots during handling.

**580-3.2 Container-Grown Plants (CG):** The Engineer will not accept any CG plants with roots which have become pot-bound or for which the top system is too large for the size of the container. Fully cut and open all containers in a manner that will not damage the root system. Do not remove CG plants from the container until immediately before planting to prevent damage to the root system.

**580-3.3 Collected Plants (Trees and Shrubs) (C):** Use C plants which have a root ball according to "Florida Grades and Standards for Nursery Plants". Do not plant any C plant before the Engineer's inspection and acceptance at the planting site.

**580-3.4 Collected Plants (Herbaceous) (HC):** The root mass and vegetative portions of collected herbaceous plants shall be as large as the specified container-grown equivalent. Do not plant any collected plant before inspection and acceptance by the Engineer.

**580-3.5 Specimen Plants (Special Grade):** When Specimen (or Special Grade) plants are required, label them as such on the plant list, and tag the plant to be furnished.

**580-3.6 Palms:** Wrap the roots of all plants of the palm species before transporting, except if they are CG plants and ensure that they have an adequate root ball structure and mass for healthy transplantation as defined in "Florida Grades and Standards for Nursery Plants".

The Engineer will not require burlapping if the palm is carefully dug from marl or heavy soil that adheres to the roots and retains its shape without crumbling. During transporting and after arrival, carefully protect root balls of palms from wind and exposure to the sun. Muck grown palms are not allowed. After delivery to the job site, if not planting the palm within 24 hours, cover the root ball with a moist material. Plant all palms within 48 hours of delivery to the site.

Move sabal and coconut palms in accordance with the "Florida Grades and Standards for Nursery Plants."

**580-3.7 Substitution of Container-Grown (CG) Plants:** With the Engineer's approval, the Contractor may substitute CG plants for any other root classification types, if he has met all other requirements of the Contract Documents.

## **580-4 Planting Requirements.**

**580-4.1 Layout:** Prior to any excavation or planting, mark all planting beds and individual locations of palms, trees, large shrubs and proposed art and architectural structures, as shown in the plans, on the ground with a common bright orange colored spray paint, or with other approved methods, within the project limits. Obtain the Engineer's approval and make necessary utility clearance requests.

**580-4.2 Excavation of Plant Holes:** Excavate plant holes after an area around the plant three times the size of the root ball has been tilled to a depth of the root ball. Ensure that the plant hole is made in the center of the tilled area only to the depth of the plant root ball.

Where excess material has been excavated from the plant hole, use the excavated material to backfill to proper level.

**580-4.3 Setting of Plants:** Center plants in the hole. Lower the plant into the hole so that it rests on a prepared hole bottom such that the roots are level with, or slightly above, the level of their previous growth and so oriented such as to present the best appearance.

Backfill with native soil, unless otherwise specified on the plans. Firmly rod and water-in the backfill so that no air pockets remain. Apply a sufficient quantity of water immediately upon planting to thoroughly moisten all of the backfilled earth. Keep plants in a moistened condition for the duration of the planting period.

When so directed, form a water ring 6 inches in width to make a water collecting basin with an inside diameter equal to the diameter of the excavated hole. Maintain the water ring in an acceptable condition.

**580-4.4 Special Bed Preparation:** Where multiple or mass plantings are to be made in extended bedding areas, and the plans specify Special Bed Preparation, prepare the planting beds as follows:

Remove all vegetation from within the area of the planting bed and excavate the surface soil to a depth of 6 inches. Backfill the excavated area with peat, sand, finish soil layer material or other material to the elevation of the original surface. Till the entire area to provide a loose, friable mixture to a depth of at least 8 inches. Level the bed only slightly above the adjacent ground level. Then mulch the entire bedding area, in accordance with 580-8.

## **580-5 Staking and Guying.**

**580-5.1 General:** When specified in the plans, or as directed by the Engineer, stake plants in accordance with the following.

Use wide plastic, rubber or other flexible strapping materials to support the tree to stakes or ground anchors that will give as the tree moves in any direction up to 30 degrees. Do not use rope or wire through a hose. Use guy chords, hose or any other thin bracing or anchorage material which has a minimum 12 inches length of high visibility flagging tape secured to guys, midway between the tree and stakes for safety.

Stake trees larger than 1 inch diameter and smaller than 2 inches diameter with a 2 by 2 inch stake, set at least 2 feet in the ground and extending to the crown of the plant. Firmly fasten the plant to the stake with flexible strapping materials as noted above.

**580-5.2 Trees of 2 to 3 1/2 inches [50 to 90 mm] Caliper:** Stake all trees, other than palm trees, larger than 2 inches caliper and smaller than 3 1/2 inches caliper with two 2 by 4 inch stakes, 8 feet long, set 2 feet in the ground. Place the tree midway between the stakes and hold it firmly in place by flexible strapping materials as noted above.

**580-5.3 Large Trees:** Guy all trees, other than palm trees, larger than 3 1/2 inches caliper, from at least three points, with flexible strapping materials as noted above.

Anchor flexible strapping to 2 by 4 by 24 inch stakes, driven into the ground such that the top of the stake is at least 3 inches below the finished ground.

**580-5.4 Special Requirements for Palm Trees:** Brace palms which are to be staked with three 2 by 4 inch wood braces, toe-nailed to cleats which are securely banded at two points to the palm, at a point one third the height of the trunk. Pad the trunk with five layers of burlap under the cleats. Place braces approximately 120 degrees apart and secure them underground by 2 by 4 by 12 inch stake pads.

#### **580-6 Tree Protection and Root Barriers.**

Install tree barricades when called for in the Contract Documents or by the Engineer to protect existing trees from damage during project construction. Place barricades at the drip line of the tree foliage or as far from the base of the tree trunk as possible. Barricades shall be able to withstand bumps by heavy equipment and trucks. Maintain barricades in good condition.

When called for in the Contract Documents, install root barriers or fabrics in accordance with the details shown.

#### **580-7 Pruning.**

Prune all broken or damaged roots and limbs in accordance with established arboriculture practices. When pruning is completed ensure that all remaining wood is alive. Do not reduce the size or quality of the plant below the minimum specified.

#### **580-8 Mulching.**

Uniformly apply mulch material, consisting of wood chips (no Cypress Mulch is allowed), pine straw, compost, or other suitable material approved by the Engineer, to a minimum loose thickness of 3 inches over the entire area of the backfilled hole or bed within two days after the planting. Maintain the mulch continuously in place until the time of final inspection.

#### **580-9 Disposal of Surplus Materials and Debris.**

Dispose of surplus excavated material from plant holes by scattering or otherwise as might be directed so that it is not readily visible or conspicuous to the passing motorist or pedestrian. Remove all debris and other objectionable material from the site and clean up the entire area and leave it in neat condition.

#### **580-10 Contractor's Responsibility for Condition of the Plantings.**

Ensure that the plants are kept watered, that the staking and guying is kept adjusted as necessary, that all planting areas and beds are kept free of weeds and undesirable plant growth and that the plants are maintained so that they are healthy, vigorous, and undamaged at the time of acceptance.

#### **580-11 Plant Establishment Period.**

If the Contract Documents designate a Plant Establishment Period, assume responsibility for the proper maintenance, survival and condition of all landscape items during such period at no additional cost.

**580-12 Method of Measurement.**

The quantities to be paid for will be the items shown in the plans, completed and accepted.

**580-13 Basis of Payment.**

Prices and payments will be full compensation for all work specified in this Section. No items for this type of work are anticipated under this contract for this Contract. Any incidental work is to be included under the related work pay item having awarded Contract Prices measured and approved.

APPENDIX "G" TO SPECIAL PROVISIONS

SECTION 630-CONDUIT

## SECTION 630 CONDUIT

### PART 1 GENERAL

#### 1.01 SUMMARY

##### A. Description

1. Furnish and install conduit for traffic control signals and devices, and other electrically powered or operated devices as shown in the Contract Documents.

##### B. Method of Measurement

1. Furnish and Install:
  - a. The Contract unit price per foot of conduit, furnished and installed, will include furnishing all hardware and materials and all testing as specified in this Section and the Contract Documents, and all labor, casings, removal of excavated materials and spoils, removal and disposal of drilling fluids, locate wire, trenching, boring, backfilling, flowable fill and restoration materials necessary for a complete and accepted installation.
  - b. Payment for conduit placed underground will be based on the horizontal length of the trench or bore measured in a straight line between the centers of pull boxes, cabinets, poles, etc., in linear feet, regardless of the length or number of conduits installed. No allowance will be made for sweeps or vertical distances below the ground.
  - c. Payment for conduit placed aboveground or bridge mounted will be based on the actual length of conduit installed.

##### C. Basis of Payment

1. Price and payment will be full compensation for all work specified in this Section.
2. Payment for conduit placed under existing turf will be made as open trench.
3. Payment for conduit placed under existing pavement (roadway, driveways, or sidewalk) will be made as directional bore. If conduit is being placed under both existing turf and existing pavement between two pull boxes, payment for the total pull box-to-pull box length will be made as directional bore. Payment for conduit placed by jack & bore will be made as jack & bore, for the total pull box to pull box length.
4. No additional payment will be made for multiple conduits in the same trench.
5. No payment adjustment will be made if Contractor chooses to use an alternative method approved by Engineer.
6. No payment will be made for failed bore paths, injection of excavatable flowable fill, products taken out of service, or incomplete installations.
7. Payment will be made under:

Item No.	Description	Unit
630-2-11	Conduit, F&I, Open Trench	LF
630-2-12	Conduit, F&I, Directional Bore	LF

**1.02 REFERENCES**

- A. Miami-Dade County Traffic Signals and Signs Division's Qualified Product List (TSSQPL)
- B. FDOT Approved Product List (APL)
- C. American Society for Testing and Materials (ASTM)
- D. American Nation Standards Institute (ANSI)
- E. National Electric Code (NEC)
- F. National Electrical Safety Code (NESC)

**PART 2 PRODUCTS**

**2.01 MATERIALS**

A. Conduit.

1. Use materials that have been tested and listed by a Nationally Recognized Testing Laboratory to the following industry standards:
  - a. Schedule 40 and 80 Polyvinyl Chloride (PVC)<sup>1</sup> ..... UL 651
  - b. Fiberglass Reinforced Epoxy<sup>2</sup> ..... UL 2420
  - c. Rigid Galvanized Metal<sup>3,4</sup> ..... UL 6
  - d. Rigid Aluminum<sup>4</sup> ..... UL 6A
  - e. PVC Coated Intermediate Metal<sup>4</sup> ..... ASTM: A135/A135M, ASTM A513, ..... ASTM A568/A568M; NEMA RN1-2005
  - f. Liquid Tight Flexible Metal ..... UL 360
  - g. HDPE SDR 9-11<sup>5</sup> ..... ASTM F2160
  - h. HDPE SDR 13.5<sup>5</sup> ..... ASTM F2160, NEMA TC-7
  - i. Schedule 40 and 80 HDPE ..... UL 651A

<sup>1</sup>Use conduit with solvent weld slip-fit plastic couplings unless approved by the Engineer.

<sup>2</sup>Use conduit having a minimum stiffness value of 250. Ensure that each section has a duct bell with an integral gasket on one end and a duct spigot on the other end.

<sup>3</sup>Use conduit that is hot-dipped galvanized with a minimum coating of 1.24 ounces per square foot on both the inside and outside of the conduit. The weight of the zinc coating shall be determined using ASTM A90.

<sup>4</sup>Use conduit with both ends reamed and threaded.

<sup>5</sup>Can be used with preassembled cable and rope-in-conduit.



## B. Locate Wire

1. Ensure that locate wire is a single copper conductor with a minimum gauge of No. 12 AWG. Ensure locate wire is insulated using a 45 mil minimum thickness polyethylene sheath that is orange in color and marked to identify the manufacturer and the conductor size.

## C. Locate Wire Grounding Unit

1. Ensure that locate wires are attached to a wire grounding unit (WGU) dedicated to safely dissipate high transient voltages or other foreign electrical surges induced into the designated system. Ensure the WGU conforms to the following:
  - a. Allows signals generated by locate system transmitters to pass through the protection system without going to ground.
  - b. The protection system automatically resets and passes locate system transmitter signals after the unit has been grounded to dissipate over-voltages.
  - c. Is intended for below or above grade applications. Ground the WGU to a driven rod within 10 feet of the system using a No. 6 AWG single conductor wire with green insulation. Ensure that the WGU is enclosed for protection from environmental hazards and is accessible for the connection of portable locate system transmitters.
  - d. The WGU system meets the minimum standards listed in Table 1 for surge protection:

Table 1: Minimum Standards for Surge Protection	
Surge Element	3-element maximum duty fail-safe gas tube.
Rating	40,000 A surge capacity (single-cycle, 8 by 20 microsecond waveform).
Life	Minimum 1,000 surges (1000 A to ground).
Fail-Safe	Integral fail-shortened device.
Insulation Resistance	1,000 megohm minimum at 100 volts of direct current (VDC).
Clamp Voltages	a. Impulse at 100 volts per microsecond: Typically 500 volts. b. Direct Current: 300 to 500 volts.

## D. Warning Tape

1. Ensure that the buried cable warning tape is flexible, elastic material 3 inches wide, 6 mil thick, intended for burial and use as an underground utility warning notice, and that the surface of the warning tape is coated and sealed to prevent deterioration caused by harsh soil elements. Ensure that the warning tape color follows the American Public Works Association color code for underground utilities and has the repeating message "CAUTION: MDC TRAFFIC CABLE," or other wording approved by the Engineer, permanently printed on its surface. Ensure that the tape material and ink colors do not change when exposed to acids, alkalis, and other destructive chemical variances commonly found in Florida soils.

## E. Route Markers

1. Route markers may be either a standard route marker (SRM) type or an electronic route marker (ERM) type. Ensure the SRM is a rigid, tubular, driven post used for location and notification purposes only. Ensure the ERM is physically identical to the SRM, but also includes a termination board to provide aboveground access to locate wire buried alongside conduit and cable runs.
2. Ensure that each SRM is labeled and identified as a MDC Traffic fiber optic cable marker unless otherwise shown in the Plans. The labels must include the County's logo, contact information for the DTPW TSS Division, and a telephone number to call prior to any excavation in the area. Ensure that the identification information is permanently imprinted on the top fitting, and will not peel, fade, or deteriorate.

F. Standard Route Marker (SRM)

1. Ensure that SRM posts are white with an orange top fitting cover with black or white lettering and graphics. Ensure that the SRM is a tubular configuration, and both the marker post and the top fitting are made from virgin Type 111 HDPE. Ensure that any fasteners used with the SRM are constructed of stainless steel.
2. Ensure that all SRMs have a minimum outside diameter of 3.5 inches with a minimum wall thickness of 0.125 inches. Ensure that the top fitting cover is a minimum of 1.5 feet long and has an outside diameter of 3.75 inches with a minimum wall thickness of 0.125 inches. Ensure that each SRM provides a tensile strength of 4,200 pounds per square inch as required in ASTM D638. Ensure that each SRM is manufactured for use in temperatures range of minus 30° to 165°F in accordance with NEMA TS 2.
3. Ensure the SRM can withstand an impact force of 70 pounds per foot at 32°F in accordance with ASTM D2444, before and after UV conditioning for 2,000 hours in accordance with ASTM G154. Ensure that the control sample of any material tested maintains a minimum of 70 percent of its original tensile strength.
4. Ensure that SRMs installed at the minimum 2 foot depth can withstand at least one impact at 45 miles per hour by a vehicle weighing at least 3,500 pounds and that after impact, post returns to an upright position within 10 degrees of vertical alignment within 30 seconds from the time of impact.

G. Electronic Route Marker (ERM)

1. Ensure ERMs meet the same material and performance requirements as the SRMs with the following exceptions.
  - a. Equip each ERM with a removable, top-fitting cover that is black with white lettering.
  - b. Ensure that each ERM contains a terminal board equipped with locate wire and ground connectors.
  - c. Ensure that the terminal board is made from corrosion-resistant materials and includes terminal facilities labeled according to function and provides uniform spacing between connection points.

## PART 3 EXECUTION

### 3.01 INSTALLATION

A. Conduit Installation Requirements

1. Install the conduit in accordance with NEC or National Electrical Safety Code (NESC) requirements and the Design Standards. Consider the locations of conduit as shown in the Plans as approximate. Construct conduit runs as straight as possible, and obtain Engineer's approval for all major deviations in conduit locations from those shown in the Plans. Include buried cable warning tape with all trenched conduit. Mark the location of the conduit system with route markers as shown in the Plans and approved by Engineer. Ensure that all route markers used are new and consistent in appearance.
2. For conduit installed by directional bore, install in accordance with FDOT Specification Section 555. For conduit installed by jack and bore, install in accordance with FDOT Specification Section 556.
3. Use only rigid galvanized metal conduit, or rigid aluminum conduit for above-ground and underground electrical power service installations. Meet the requirements of FDOT Specification Section 562 for coating all field cut and threaded galvanized pipe.
4. Use Schedule 80 PVC or fiberglass reinforced epoxy conduit in structural elements in or on bridge decks.
5. Use HDPE with an SDR number less than or equal to 11, Schedule 80 PVC or Schedule 40 PVC for underground installations in earth or concrete for ITS and traffic control signal applications, except, use only HDPE with an SDR number less than or equal to 11 for blown fiber optic cable installations on limited access facilities.
6. Use HDPE with an SDR number less than or equal to 13.5, Schedule 80 PVC, or Schedule 40 PVC for underground installations of electrical conduit in earth for lighting applications and landscape irrigation applications.
7. Use HDPE with an SDR number less than or equal to 13.5, Schedule 80 PVC, Schedule 40 PVC, or rigid galvanized metal for underground installations of electrical conduit in concrete for lighting applications.
8. Do not place more than the equivalent of three quarter bends or 270 degrees of bends, including the termination bends, between the two points of termination in the conduit, without a pull box. Obtain Engineer's approval to use corrugated flexible conduits for short runs of 6 feet or less.
9. When a conduit installation changes from underground to above-ground, make the change a minimum of 6 inches below finished grade.
10. Install a No. 12 AWG pull wire or polypropylene cord inside the full length of all conduits. Ensure that a minimum of 24 inches of pull wire/cord is accessible at each conduit termination.
11. Ensure the conduit includes all required fittings and incidentals necessary to construct a complete installation.
12. When earth backfill and tamping is required, place backfill material as per FDOT Section 120 in layers approximately 12 inches thick, and tamp each layer to a density equal to or greater than the adjacent soil.
13. When backfilling trenches in existing pavement, use a flowable fill meeting the requirements of FDOT Specification Section 121.
14. Provide a standard clearance between underground control cable and electrical service cable or another parallel underground electrical service cable that meets NESC requirements.
15. Prevent the ingress of water, dirt, sand, and other foreign materials into the conduit prior to, during, and after construction. Seal the ends of conduit after wiring is complete with a moisture resistant sealant that is designed for this specific application.

B. Fiber Optic Cable Conduit

1. Install the conduit system so the fiber optic cable maintains a minimum bend radius of 20 times the cable diameter. Use approved methods for connecting inner duct or conduit within or between plowed portions, trenched portions, and bored portions. Submit the conduit manufacturer's coupling method and material to Engineer for approval.

C. Conduit Sizes

1. Size the conduit to be used on all installations, unless otherwise shown in the Contract Documents. Use conduit of sufficient size to allow the conductor to be installed without any damage and meeting NEC requirements. Use conduit that is at least 2 inches in diameter, with the following exceptions:
  - a. For conduit protecting the ground wire on the side of a pole, use conduit that is at least 1/2 inch in diameter.
  - b. For ITS applications where Contractor chooses to install fiber optic cable by blowing, use conduit that is at least 1-1/4 inch in diameter.
  - c. For traffic control signal and device electrical service conduit, use the minimum conduit size required by the Department and the electrical service provider.
  - d. Where larger size conduits are required by the Miami-Dade County Traffic Control Equipment Standards and Specifications.

D. Conduit Joints

1. Make conduit joints using materials as specified by the manufacturer. When conduit crosses an expansion joint of a structure and where shown in the Plans, install an expansion or expansion/deflection fitting as specified by the manufacturer. Certify that expansion/deflection fittings are rated to accommodate a minimum rotation of 30 degrees and that both the expansion and expansion/deflection fittings are rated to accommodate the anticipated longitudinal movement (minimum of 2 inches for deflection fittings and 0.7 inches for expansion/deflection fittings). Ensure that all installed joints are waterproof. As an exception to the threaded coupling for intermediate metal conduit, at locations where it is not possible to screw the threaded coupling properly, Contractor may use a waterproof slip-joint coupling approved by Engineer. Secure the joint, and tighten threaded connections.
2. Prior to insertion into the coupling, clean, prime and coat the ends of PVC conduit with solvent-type cement as specified by the manufacturer.

E. PVC Coating

1. Apply PVC coating to exposed metal surfaces of the conduit, except for the threads, to attain a nominal thickness of 40 mils. Ensure that the coating is free of sags and drips.
  - a. Attach the coupling to the conduit prior to the application of the coating for conduit of 1 inch diameter or less.
  - b. Use a coupling with sleeve extensions on conduit larger than 1 inch. Ensure that the sleeve extensions on all threaded female openings have a length equal to the diameter of the conduit up to and including size number 53.

F. Conduit Terminations

1. Fit the terminating ends of all metal conduit and metal conduit sleeves with an appropriate bushing.

2. For conduit to be encased in concrete, wrap with tape or otherwise protect all terminations to prevent the entrance of concrete.
3. Connect new underground conduits to existing underground conduits with a pull box.
4. Install conduit terminating in a concrete strain pole through the cable entry hole and up the center of the pole to a location approximately 6 inches below the handhole.
5. Seal conduits terminating in a controller base, pole, pull box, junction box, or pedestal base with a moisture resistant sealant approved by Engineer.
6. For a controller base, pole or pedestal base, and junction boxes, terminate conduit runs into the center of the base or box at least 2 inches above the surface of the base.

#### G. Restoration of Trench Areas

1. Restore the conduit trench construction area to an acceptable condition. Such work includes repair or replacement of all pavement areas, sidewalks, driveways, curbs, structures, landscaping, grass areas (including removal of excavated materials and spoils), removal and disposal of drilling fluids, and backfilling areas disturbed by the conduit installation.

#### H. Above Ground Installation

1. Use conduit designed and manufactured for use in long-term above-ground applications with UV stabilization to prevent material deterioration. Securely attach above-ground conduit installations to the surface of the supporting structure using conduit straps. As a minimum, use conduit straps located on 5 foot centers. Use galvanized metal conduit straps when installing intermediate metal conduit, fiberglass reinforced epoxy conduit, rigid galvanized conduit, rigid aluminum conduit or PVC coated intermediate metal conduit above ground.
2. Use the same PVC coating for the metal straps as the conduit, when using PVC coated intermediate metal conduit.

#### I. Elbows

1. The radius of curvature of the centerline of any bend shall not be less than shown below:

Size	Standard Radius
1/2 inch	4 inches
3/4 inch	4-1/2 inches
1 inch	5-1/2 inches
1-1/4 inches	7-1/4 inches
1-1/2 inches	8-1/4 inches
2 inches	9-1/2 inches
2-1/2 inches	10-1/2 inches
3 inches	13 inches
3-1/2 inches	15 inches
4 inches	16 inches

Size	Standard Radius
5 inches	24 inches
6 inches	30 inches

J. Fiber Optic Cable Locate Wire

1. Install locate wire in the trench or bore with all underground conduits to provide end-to-end electrical continuity for electronically locating the underground conduit system. Bury locate wire along the centerline of the top outer surface of installed conduit. Do not install locate wire in a conduit with fiber optic cable.
2. Do not run locate wires into field cabinets. Terminate locate wires at the first and last pull boxes in the conduit run or as shown in the Plans. Ensure that wire termination occurs in a pull box as shown in the Miami-Dade Conduit Installation Details (N.T.S).
3. In a trenching operation, install the locate wire no more than 3 inches above the conduit. Ensure that the locate wire enters all pull and splice boxes, and that a minimum of 10 feet of slack locate wire is coiled and neatly stored in each box.
4. In a boring operation, install the locate wire in an encasement, install the conduit detection wire external to the conduit with no separation between conduit and wire, or use conduit with integral locate wire. Locate wire may also be placed in the void between the inner wall of conduit and innerducts contained within the conduit as long as no other cables are present within the void.
5. Perform continuity tests and insulation resistance tests on all locate wires and provide Engineer with all test results. Replace, or repair defective locate wire at no additional cost.
6. Make locate wire splices in a flush grade-level box. Ensure that locate wire splices are waterproof and suitable for direct burial. Ensure that locate wire splices at the pull box meet NEC requirements. Ensure that locate wire splices are constructed of and in the following order: a mechanical crimp connection with a butt sleeve, an oxide-preventing aerosol lacquer, mastic electrical splicing tape, and standard electrical tape. At the completion of the installation, provide Engineer with as-built drawings that document all splice locations.
7. Install WGUs in pull boxes and splice boxes as shown in the Plans or directed by the Engineer. Mount the device in a location high enough from the bottom of the box to allow access to terminal facilities without disturbing cables present within the box. Terminate the locate wires and connect the WGU to ground in accordance with the manufacturer's instructions.
8. Test the locate wire system after installation to ensure that it functions and can be used to accurately locate the conduit system.

K. Route Markers

1. Install route markers for fiber optic cable installations as detailed in FDOT Specification Section 630-3.10.

END OF SECTION 630

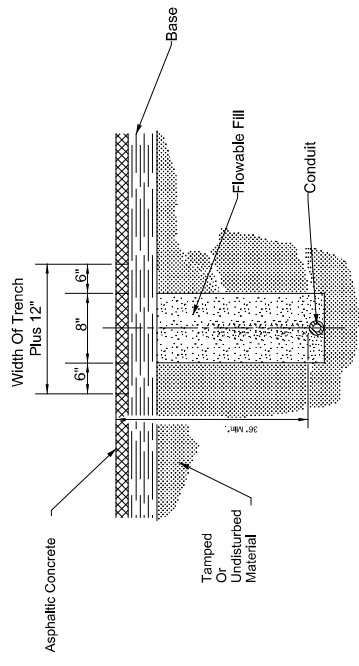

FOR USE IN INSTALLING CONDUIT UNDER EXISTING ASPHALT PAVEMENT NOT ADJACENT TO GUTTER WHEN JACKING OR DIRECT BORING IS NOT FEASIBLE

FIGURE C

Notes:

1. Rigid conduit must be used when jacking under existing pavement at 36" minimum depth.
2. Asphalt to be sawcut at the edges of the trench.

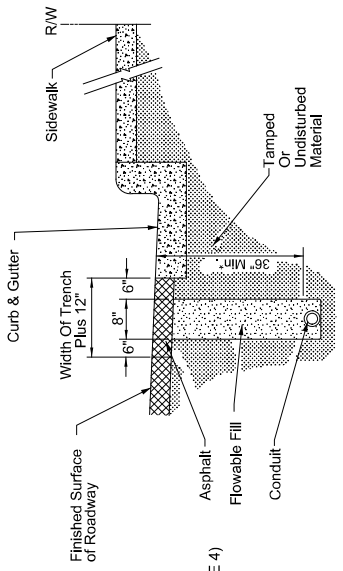

FOR USE IN ASPHALT ROADWAY ADJACENT TO GUTTER WHEN PLACEMENT OUTSIDE OF THE PAVEMENT IS NOT FEASIBLE.

FIGURE B

Notes:

1. Trench not to be open more than 250' at a time when construction area is subject to vehicular or pedestrian traffic.
2. Asphalt to be sawcut to leave neat lines at the pavement cut.

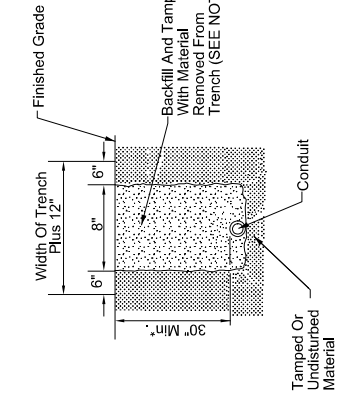

FOR USE IN AREAS NOT EXPOSED TO VEHICULAR TRAFFIC

FIGURE A

Notes:

1. Sidewalk patches to match existing joints.
2. Entire sidewalk slab must be replaced when specified in the plans.
3. Backfill and tamp with material from trench backfill (SEE NOTE 4). All trench walls and bottom of trench within the driveway entirely with Flowable Fill.
4. Remove and replace additional pavement within 6' of trench.

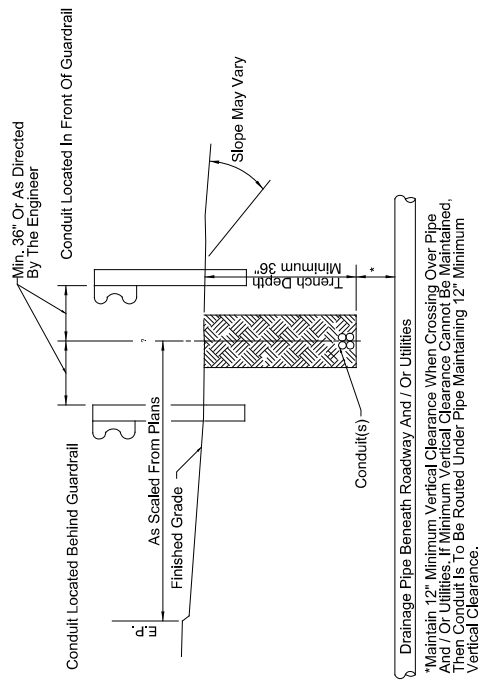
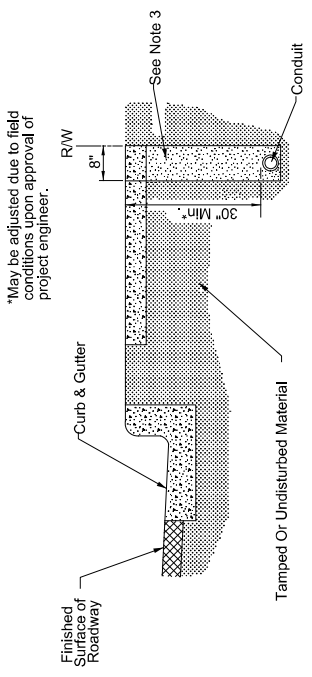

FIGURE F

Drainage Pipe Beneath Roadway And / Or Utilities  
 \*Maintain 12" Minimum Vertical Clearance When Crossing Over Pipe And / Or Utilities. If Minimum Vertical Clearance Cannot Be Maintained, Then Conduit Is To Be Routed Under Pipe Maintaining 12" Minimum Vertical Clearance.



FOR USE IN INSTALLING CONDUIT UNDER SIDEWALK

FIGURE E

\*May be adjusted due to field conditions upon approval of project engineer.

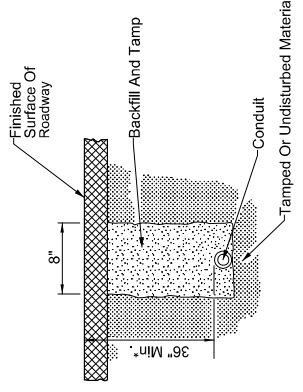

FOR USE INSTALLING CONDUIT UNDER A NEW ROADWAY PRIOR TO INSTALLATION OF BASE AND PAVEMENT

FIGURE D

DATE 03/3/17	REVISION	DESCRIPTION	 DTPW TRAFFIC SIGNALS AND SIGNS DIVISION MIAMI, FLORIDA 33166 305.592.5980	DRAWN CHECKED DESIGNED APPROVED BY FRANK AHA, P.E.	NAME TITLE NUMBER	DATE 12-09-16 12-22-17	SHEET 1 of 2
				CONDUIT INSTALLATION DETAILS (N.T.S.)			

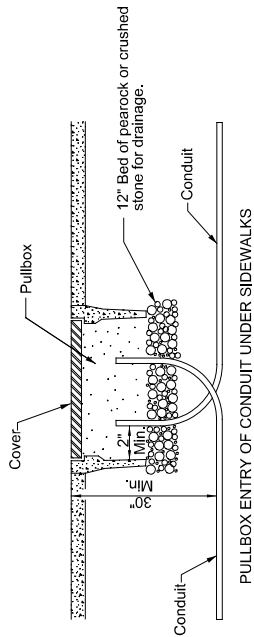
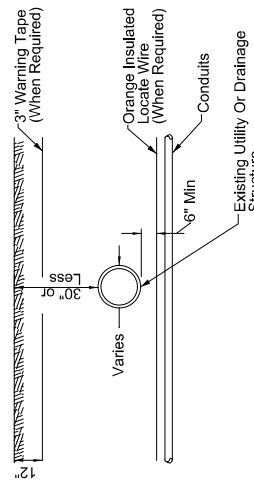
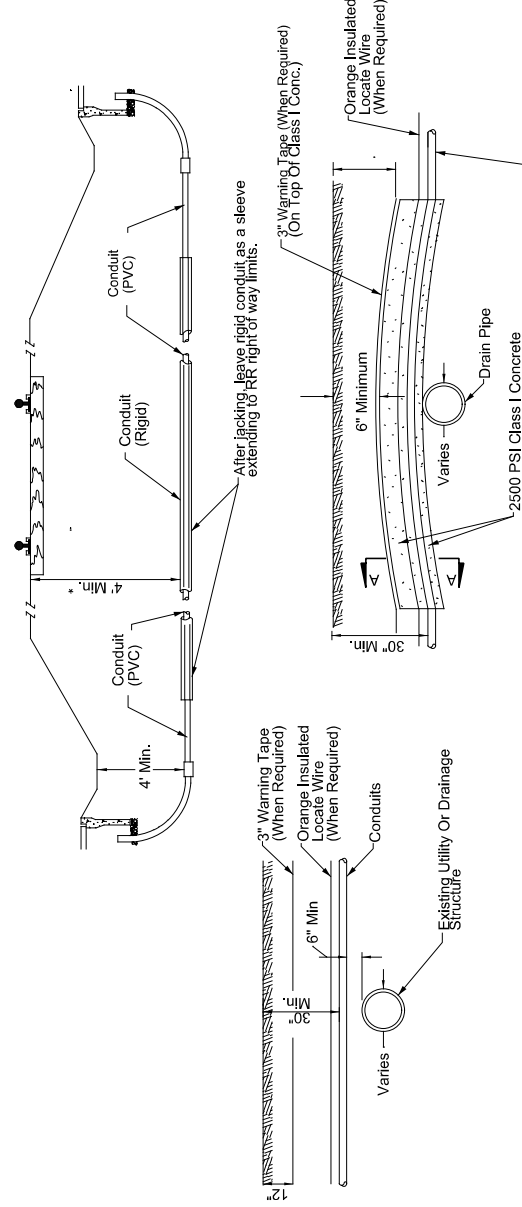

FIGURE G

Note:

Ends of conduit shall be sealed in accordance with Section 630 of the FDOT Standard Specifications for Road and Bridge Construction, and the Miami-Dade County Traffic Control Equipment Standards and Specifications.

FIGURE I  
FOR USE UNDER RAILROADS



CONDUIT INSTALLATION DETAILS ACROSS EXISTING DRAIN PIPES OR UTILITIES

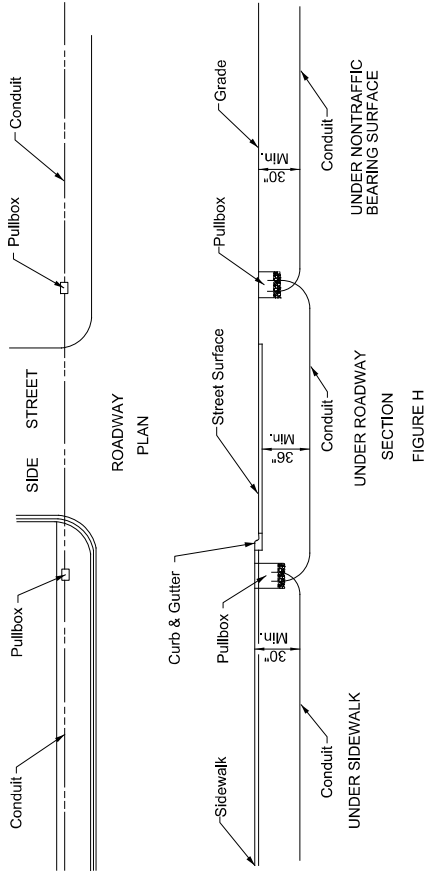

FIGURE H

GENERAL NOTES:

1. MEET THE REQUIREMENTS OF MIAMI-DADE COUNTY TRAFFIC CONTROL EQUIPMENT STANDARDS AND SPECIFICATIONS SECTION 630 (CONDUIT).
2. THE CONTRACTOR, WITH APPROVAL FROM THE ENGINEER, MAY ADJUST THE FINAL BURIAL DEPTH OF THE CONDUIT(S) IN ORDER TO TRANSVERSE NONMOVABLE OBJECT CONFLICTS.
3. BACKFILL WITH EXCAVATED MATERIAL AND COMPACT THE SOIL UNTIL FIRM AND UNYIELDING. REMOVE ROCK AND DEBRIS FROM BACKFILL MATERIAL.
4. WHERE CONDUITS ARE TO BE INSTALLED OVER EXISTING UNDERGROUND STRUCTURES (E.G., DRAIN PIPES OR UTILITY LINES) WHICH ARE LESS THAN 30" DEEP, THE CONDUIT SHALL BE INSTALLED IN A CONDUIT IN 2500 PSI CLASS I CONCRETE FOR THE ENTIRE LENGTH OF CONDUIT THAT IS INSTALLED AT A DEPTH OF LESS THAN 30".
5. IF THE AMOUNT OF COVER OVER THE ENCASMENT IS LESS THAN 6", THE CONTRACTOR SHALL INSTALL THE CONDUIT TO PASS BELOW THE UNDERGROUND STRUCTURES (E.G., DRAIN PIPES).

REVISION	DATE
03/23/17	12/09/16

DESCRIPTION:

DTPW TRAFFIC SIGNALS AND SIGNS DIVISION  
100 NW 36th STREET  
MIAMI, FL 33142  
305.582.3690



DATE	12/09/16
NAME	TRAVIS BREWER
BY	TRAVIS BREWER
CHECKED	MARC FERNANDEZ
APPROVED	BY: FRANK ABAL, P.E.

CONDUIT INSTALLATION DETAILS (N.T.S.)



APPENDIX "H" TO SPECIAL PROVISIONS  
SECTION 635-PULL, SPLICE, AND JUNCTION BOXES

**SECTION 635  
PULL, SPLICE, AND JUNCTION BOXES**

**PART 1 GENERAL**

**1.01 SUMMARY**

A. Description

1. Furnish and install pull, splice, and junction boxes as shown in the Plans.

B. Method of Measurement

1. The Contract unit price each for pull, splice, and junction box, furnished and installed, will consist of the pull, splice, and junction box including all required hardware for the type of box and location as specified in the Contract Documents, and all labor and materials necessary for a complete and accepted installation.

C. Basis of Payment

1. Price and payment will be full compensation for all work specified in this Section, except grounding.
2. No separate payment for embedded junction boxes will be made. The Contractor shall include the cost of embedded junction boxes in the Contract unit price for the concrete substructure or superstructure items.
3. No separate payment will be made for the removal of pull, splice, and junction boxes.
4. Payment will be made under:

Item No.	Description	Unit
635-2-11	Pull & Splice Box, F&I, 13" X 24" Cover Size	EA
635-2-12	Pull & Splice Box, F&I, 24" X 36" Cover Size	EA
635-3-11	Junction Boxes, F&I, Aerial	EA
635-3-12	Junction Boxes, F&I, Mounted	EA

**1.02 REFERENCES**

- A. Miami-Dade County Traffic Signals and Signs Division's Qualified Product List (TSSQPL)
- B. FDOT Approved Product List (APL)
- C. American Society for Testing and Materials (ASTM)
- D. American Nation Standards Institute (ANSI)

**PART 2 PRODUCTS**

## 2.01 MATERIALS

### A. General.

1. Use only pull and splice boxes that meet the requirements of this Specification and are listed on the FDOT's Approved Products List (APL) and the Department's Traffic Signals and Signs Division's Qualified Products List (TSSQPL).

### B. Pull and Splice Boxes

#### 1. General

- a. Manufacturers of concrete pull and splice boxes and covers must meet the requirements of FDOT Sections 105 and be currently on the FDOT's Production Facility Listing and.
- b. Ensure box bodies and covers are free of flaws such as cracks, sharp, broken, or uneven edges, and voids.
- c. Ensure in-ground boxes have an open bottom design.

#### 2. Marking

Ensure the following information is permanently cast into the top surface of all pull and splice box covers:

- a. Unless otherwise shown in the Plans, mark application as follows:
    - 1) "TRAFFIC SIGNAL" for signalized intersections
    - 2) "FIBER OPTIC CABLE" for fiber optic cable
    - 3) "LIGHTING" for highway lighting
    - 4) "ELECTRICAL" for other electrical applications
  - b. Manufacturer's name or logo
  - c. FDOT APL or Miami-Dade County TSSQPL approval number
  - d. TIER rating
3. Ensure the date of manufacture (month/day/year, or date code) is permanently located on the top or bottom of the cover. Ensure the interior of the box body has a permanent marking that includes the manufacturer part/model number and date of manufacture near the top of box in a location that is visible after installation when the cover is removed.
  4. Dimensions
    - a. Unless otherwise shown in the Plans, provide pull and splice boxes with the following dimensions.
      - 1) For signalized intersection and lighting applications, provide pull boxes with nominal cover dimensions of 13 inches wide by 24 inches long or larger and no less than 12 inches deep. Ensure the inside opening area is a minimum of 240 square inches and no inside dimension is less than 12 inches.
      - 2) For fiber optic cable applications, provide pull boxes with nominal cover dimensions of 24 inches wide by 36 inches long or larger and no less than 24 inches deep.
      - 3) Provide rectangular splice boxes with nominal cover dimensions of 30 inches wide by 60 inches long or larger and no less than 36 inches deep. Provide round splice boxes with a nominal cover diameter of 36 inches or larger and no less than 36 inches deep.

## 5. Fabrication

- a. Provide box covers constructed of concrete, polymer concrete or other materials meeting the requirements of this Section.
- b. Provide box covers with lifting slots and a flush-seating lockdown mechanism. Use penta-head lockdown lag bolts. Ensure lockdown bolts and lifting slots are Type 316, 304, or 302 passivated stainless steel or brass. Ensure lockdown bolt assembly is designed to prevent seizing and can be removed without damaging the cover or box body. Ensure the lockdown bolt threaded insert/nut assembly is field replaceable.

## 6. Testing Requirements:

For all pull and splice boxes submitted provide test data demonstrating conformance with the American National Standards Institute/Society of Cable Telecommunications Engineers (ANSI/SCTE) 77 2013 Specification for Underground Enclosure Integrity for TIER 15.

## C. Junction Boxes

## Fabrication.

Provide galvanized steel, aluminum or NEMA 4X non-metallic junction boxes. Ensure all attachment hardware is Type 316 or 304, passivated stainless steel.

1. Ensure the outside surface has a smooth, uniform finish. Ensure boxes are free of burrs, pits, sharp corners and dents. Ensure all welds are neatly formed and free of cracks, blow holes, and other irregularities.
  - a. Aerial Junction Boxes
 

Unless otherwise shown in the Plans, provide aerial junction boxes with minimum inside dimensions of 8 inches wide by 8 inches long and at least 3 inches deep.
  - b. Mounted Junction Boxes
 

Provide mounted junction boxes fabricated of 5052 sheet aluminum alloy with a minimum thickness of 1/8 inch. Ensure all mounted junction boxes have a hinged door and lock as specified in FDOT Specification Section 676.

Unless otherwise shown in the Plans, provide mounted junction boxes for the following installations:

    - 1) For pole and cabinet mounted installations, provide junction boxes with minimum inside dimensions of 13 inches long by 10 inches wide and at least 3 inches deep.
    - 2) For base mounted installations, provide junction boxes with minimum inside dimensions of 21 inches long by 10 inches wide and at least 8 inches deep.
  - c. Embedded Junction Boxes
    - 1) Provide weatherproof embedded junction boxes for use in concrete substructures or superstructures. Include gasketed weatherproof covers made of the same material as the box and Type 316 or 304, stainless steel, tamper resistant screws for securing the cover. Fabricate galvanized steel boxes and their covers from steel meeting the requirements of ASTM A36 and galvanized in accordance with ASTM A123.
    - 2) For embedded junction boxes not exposed to vehicular impacts, provide the following types of junction boxes.
      1. Where the structure's environmental classification is slightly or moderately aggressive, provide a galvanized steel or NEMA 4X (non-metallic) box, as approved by the Engineer.

2. Where the structure's environmental classification is extremely aggressive, provide a NEMA 4X (non-metallic) box, unless otherwise directed by the Engineer.
  - 3) For embedded junction boxes exposed to vehicular impacts, provide a galvanized steel box regardless of the structure's environmental classification.
2. Barrier Terminal Blocks
- a. Provide a barrier terminal block with a minimum of ten positions and rated at 600 V<sub>AC</sub> in all aerial and mounted junction boxes. Ensure each terminal block position has two screws electrically connected by a shorting bar or other Department approved method. Ensure all terminal block positions are numbered sequentially.

## PART 3 EXECUTION

### 3.01 INSTALLATION

#### A. General

1. Do not install power and communication cables in the same box unless otherwise shown in the Plans.
2. When signal or 120 volt (or greater) power is present, ground all metal covers in accordance with FDOT Specification Section 620.

#### B. Pull and Splice Boxes

Install pull and splice boxes in accordance with the Miami-Dade Pull Box / Fiber Optic Box Details (N.T.S), Index. Ensure pull and splice boxes are sized for the amount of cable to be placed inside. Ensure that the pull or splice box cover is flush with the concrete apron or sidewalk. Do not install pull or splice boxes in roadways, driveways, parking areas, ditches or public sidewalk curb ramps. Avoid placing pull and splice boxes in low-lying locations with poor drainage. Ensure that pull and splice boxes house fiber optic cable without subjecting the cable to a bend radius less than 14 times the diameter of the cable.

##### 1. Placement and Spacing

Place pull and splice boxes as shown in the Plans and at the following locations, unless directed otherwise by Engineer:

- a. At all major fiber optic cable and conduit junctions.
- b. Approximately every 2,500 feet for fiber optic cable applications in rural areas with any continuous section of straight conduit if no fiber optic cable splice is required.
- c. At a maximum of 1,760 feet for fiber optic cable applications in metropolitan areas.
- d. At each end of a tunnel, and on each side of a river or lake crossing.
- e. On each side of an aboveground conduit installation, such as an attachment to a bridge or wall.
- f. At all turns in the conduit system.
- g. Near the base of a service pole or communication cabinet to provide:
  - 1) A transition point between the fiber optic conduits extending from the fiber backbone and the conduit feeding the communication cabinet.
  - 2) An assist point for the installation of fiber optic drop cable.
  - 3) Storage of slack fiber optic drop cable.

2. Electronic Box Marker

Equip all pull and splice boxes buried below finish grade with an electronic box marker inside the pull or splice box to mark the location. Ensure that the electronic box marker is a device specifically manufactured to electronically mark and locate underground facilities. Ensure that the electronic box marker includes circuitry and an antenna encased in a waterproof polyethylene shell. Ensure that the outer shell is impervious to minerals, chemicals, and temperature extremes normally found in underground plant environments. Ensure that the electronic box marker does not require any batteries or active components to operate. Ensure that electronic box markers used to mark fiber optic cable and general telecom applications are orange in color and operate at 101.4 kHz. Ensure that the electronic box marker's passive circuits produce an RF field when excited by a marker locator to direct the locator to the marker's position. Ensure that the electronic box marker has a minimum operating range of 5 feet from the marker locator.

C. Aerial Junction Boxes

Install aerial junction boxes in accordance with FDOT Design Standards, Index No. 17733.

D. Mounted Junction Boxes

Ensure that the bottom surface of pole mounted junction boxes is a minimum of 4 feet above the finished grade.

E. Cable Terminations

Make cable terminations in junction boxes in accordance with FDOT Specification Section 632. Route and form the cable to allow access to the terminal screws. Do not cover the terminal identification numbers with the cable.

END OF SECTION 635

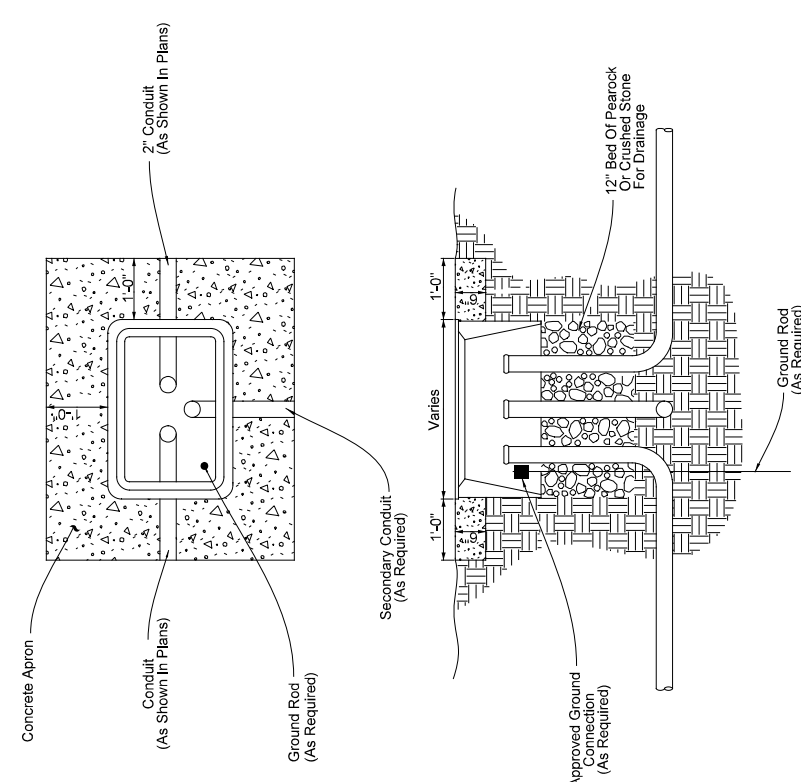

PULL BOX

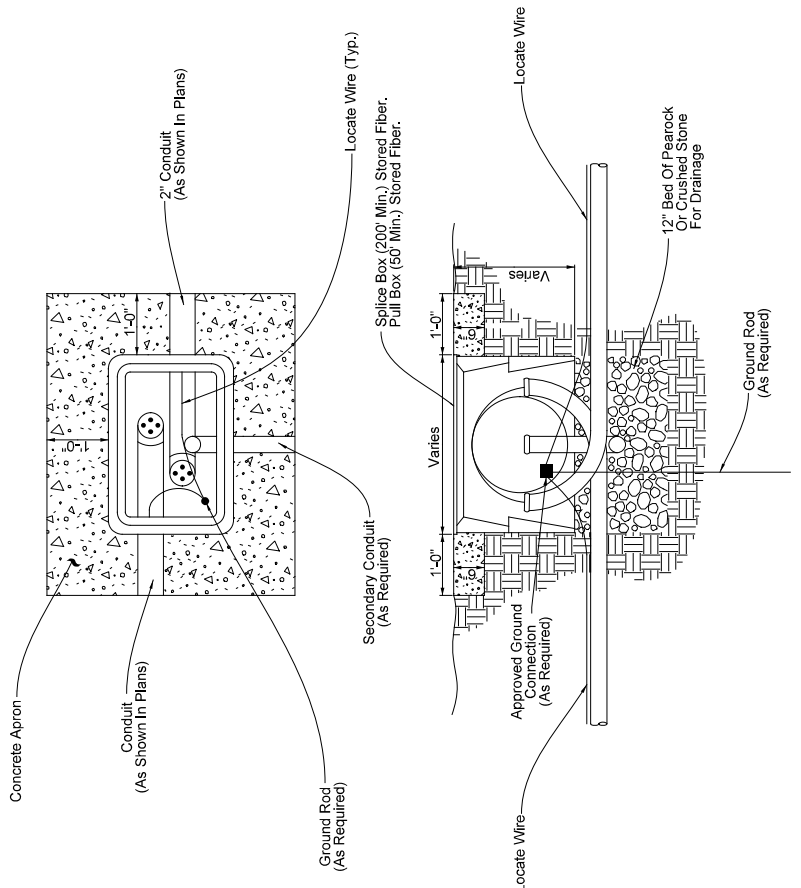

FIBER OPTIC BOX

Rectangular boxes are depicted. Round fiber optic splice boxes and lids are allowed.

GENERAL NOTES:

1. MEET THE REQUIREMENTS OF MIAMI-DADE COUNTY TRAFFIC CONTROL EQUIPMENT STANDARDS AND SPECIFICATIONS SECTION 635 (PULL, SPLICE, AND JUNCTION BOXES)
2. BOXES SHALL NOT BE INSTALLED IN ROADWAYS OR DRIVEWAYS.
3. BOXES SHALL BE ON THE FOOT APPROVED PRODUCT LIST (APL) AND THE MIAMI-DADE COUNTY QUALIFIED PRODUCT LIST (QPL)
4. BOXES SHALL BE INSTALLED FLUSH WITH THE FINISHED GRADE SURFACE.
5. FIBER OPTIC SPLICE BOXES SHALL BE PROVIDED WITH CABLE HANGER RACKS DESIGNED TO SUPPORT CABLES AND SPLICE ENCLOSURES. COST OF RACKS TO BE INCLUDED IN COST OF SPLICE BOX.
6. FIBER OPTIC BOXES SHALL CONTAIN ONLY FIBER OPTIC CABLE, CONDUIT, AND LOCATE WIRE

7. CONDUIT CENTER LINE SHALL BE ALIGNED TO TOP EDGE OF BOX TO FACILITATE CABLE PULLING.

8. CONDUIT CENTER LINE SHALL BE ALIGNED TO TOP EDGE OF BOX TO FACILITATE CABLE PULLING.

9. ALL BOXES SHALL HAVE 1'-0" WIDE (MIN.) CONCRETE APRON. CONCRETE FOR CONCRETE APRONS SHALL BE CLASS NS WITH A MINIMUM STRENGTH AT 28 DAYS OF FC=2.5 KSI. APRONS SHALL BE SLOPED AWAY FROM BOX. COST OF APRON TO BE INCLUDED IN THE COST OF EACH BOX.

10. PREVENT THE INGRESS OF WATER, DIRT, SAND AND OTHER FOREIGN MATERIALS INTO THE CONDUIT PRIOR TO DURING AND AFTER CONSTRUCTION USING A FOAM-SEALING MATERIAL, RUBBER PLUG, OR OTHER DEVICE DESIGNED FOR THIS APPLICATION.

11. WHERE MULTIPLE PULL BOXES ARE PLACED SIDE BY SIDE, MAINTAIN AT LEAST 8\"/>

LATEST REVISION	03/31/17
-----------------	----------

DESCRIPTION:  
TRAFFIC CONTROL EQUIPMENT STANDARDS AND SPECIFICATIONS



DTPW TRAFFIC SIGNALS AND SIGNS DIVISION  
395-592-5946

DATE	12-09-16
NAME	IS-09-16
DESIGNED	10-22-17
CHECKED	10-22-17
APPROVED	10-22-17

PULL BOX / FIBER OPTIC BOX DETAILS (N.T.S.)

APPENDIX "1" TO SPECIAL PROVISIONS  
SECTION 639-ELECTRICAL POWER SERVICE ASSEMBLY



# SECTION 639 ELECTRICAL POWER SERVICE ASSEMBLY

DATED: AUGUST 2015

## INDEX FOR SECTION 639

SHEET NO.	SHEET DESCRIPTION
639-1	INDEX SHEET.
639-2	STANDARDS AND SPECIFICATIONS.
639-3	ELECTRICAL POWER SERVICE ASSEMBLY DETAILS



TRAFFIC CONTROL EQUIPMENT STANDARDS AND SPECIFICATIONS  
FOR MIAMI-DADE COUNTY

LATEST REVISION 08/21/15	DESCRIPTION:	TRAFFIC CONTROL EQUIPMENT STANDARDS AND SPECIFICATIONS	MIAMI-DADE COUNTY	PWSM TRAFFIC SIGNALS AND SIGNS DIVISION 7100 N.W. 36TH STREET MIAMI, FL 33166 305.592.3580 <small>APPROVED BY: PWSM 08/21/15</small>	<table border="1" style="width: 100%; border-collapse: collapse;"> <tr> <td style="font-size: 8px;">NAME</td> <td style="font-size: 8px;">DATE</td> </tr> <tr> <td style="font-size: 8px;">DRAWN (DRAWN)</td> <td style="font-size: 8px;">08-31-15</td> </tr> <tr> <td style="font-size: 8px;">CHECKED (CHECKED)</td> <td style="font-size: 8px;">08-31-15</td> </tr> </table>	NAME	DATE	DRAWN (DRAWN)	08-31-15	CHECKED (CHECKED)	08-31-15	SHEET NO. 639-1
NAME	DATE											
DRAWN (DRAWN)	08-31-15											
CHECKED (CHECKED)	08-31-15											
		ELECTRICAL POWER SERVICE ASSEMBLY INDEX SHEET										

**SECTION 639  
ELECTRICAL POWER SERVICE ASSEMBLY**

**PART 1 GENERAL**

**1.01 SUMMARY**

- A. Description
- Furnish and install Electrical Power Service Assembly in accordance with the Plans and the details provided with these Specifications including all required conduit, electrical service wire, pull boxes, meter socket, service disconnect(s), grounding, surge protective device, and miscellaneous appurtenances needed for a complete installation. Provide all labor, material and equipment necessary to make a complete and accepted installation including the coordination of service with the electrical power company and connecting to the supplied power company electrical source.

B. Products Required But Not Supplied Under This Section

- Concrete strain pole

C. Related Sections

- Section 562 Repair of Galvanized Surfaces
- Section 620 Grounding
- Section 630 Conduit
- Section 635 Pull and Junction Boxes
- Section 641 Concrete Strain Pole

D. Method of Measurement

- Electrical Power Service Assembly: The Contract unit price per assembly for Electrical Power Service includes all labor, equipment, material and services for a complete and accepted installation as specified herein. Payment for conduit and electrical service wire which is vertically attached to the electrical power assembly is considered incidental and not paid for separately. Measurement and payment for concrete strain pole(s) provided under a separate Contract pay item.
- For use in maintenance and repair work:
  - Electrical Service Wire: The Contract unit price per foot of electrical service wire, furnished and installed, will include furnishing all materials and hardware as specified in the Contract Documents, and all labor, equipment, and miscellaneous materials necessary for a complete and accepted installation. Payment for Electrical Service Wire is based upon the distance of the cable run and includes payment for all conductors used in the run.
  - Electrical Service Disconnect: The Contract unit price each for electrical service disconnect, furnished and installed, will include furnishing all materials and hardware as specified in the Contract Documents, and all labor, equipment, and miscellaneous materials necessary for a complete and accepted installation.

E. Basis of Payment

- Prices and payments will be full compensation for all work specified in this Section.
- Payment will be made under:

Item No.	Description	Unit
639-1-121	Electrical Power Service, F&I, Underground, Meter Furnished By Power Company	AS
639-2-1 G	Electrical Service Wire	LF
639-3-11	Electrical Service Disconnect, F&I, Pole Mount	AS

**1.02 SYSTEM DESCRIPTION**

- A. Design Requirements

- Provide a single concrete strain pole with service disconnect and meter socket in the right-of-way at a readily accessible location nearest the point of entrance of the conductors into the controller cabinet, typically within 15 feet of the cabinet.
- Locate the electrical power company service point as close as possible to the controller cabinet at a distance not to exceed 300 feet from the cabinet. A service point location greater than 300 feet from the cabinet requires additional engineering and approval from the power company. The cabinet location shall be subject to additional engineering and approval from the power company. Increasing the size of the conductors and placing a second pole and disconnect near the service point. When two disconnects are required, the pole closest to the service point will support the main disconnect and the meter socket.
- Voltage drop in feeder or branch circuits must not exceed three percent and the total combined voltage drop for the entire circuit must be less than five percent. When the distance from the service point and the controller is greater than 300 feet, increase the conductor size accordingly to maintain the permissible voltage drop.
- Locate pull boxes so that no conduit runs exceed 250 feet in length.
- Provide bonding, grounding, and lightning protection pursuant to Section 620.

**PART 2 PRODUCTS**

**2.01 MATERIALS**

- A. Electrical Conduit: Use conduit meeting the requirements of Section 630. Meet the requirements of Section 562 for coating all field cut and threaded galvanized pipe.

- Rigid Steel Conduit: Conduit and fittings must meet the requirements of UL 6 and shall be hot dip galvanized. Each section of conduit must bear the UL label.
- Rigid Nonmetallic Conduit: Use Schedule 80 nonmetallic conduit. Conduit and fittings must be polyvinyl chloride heavy wall meeting the requirements of UL 651. Each section of conduit must bear the UL label.

B. Electrical Service Wire:

- Grounding conductor must be type THWN, for all other conductors, use minimum No. 6 AWG stranded copper wire with XHHW (cross-linked polyethylene (XLPE) high heat-resistant, water-resistant) insulation, rated at 600 V in dry and wet condition.
- Service wire must be continuously run wire. Splices are not permitted.

- C. Meter Socket: Meter socket must be aluminum, Florida Power and Light listed Category 33a with isolated neutral, Landis & Gyr/Talon 41405-025F or approved equal.

D. Service Disconnect:

- Enclosure (Cabinet): Use stainless steel enclosure conforming to National Electrical Manufacturers Association (NEMA) Standards for Type 4X that is approved and listed in the TSSQP. Ensure that the inside dimensions meet NEC requirements.

- Circuit Breaker: Use a manually resettable circuit breaker which has a current rating above the current rating of the circuit breaker to which electrical power is provided. Do not use less than a 40A circuit breaker.

- Surge Protective Device: Use a lightning arrester rated for a maximum permissible line to ground voltage of 175 VAC.

- Attachment Hardware: Use attachment hardware that meets the requirements of Section 600.

**PART 3 EXECUTION**

**3.01 INSTALLATION**

- A. General: Meet the following requirements for the installation of individual components of the electrical power service assembly:

- Use extreme care and caution in the installation of all components of the electrical power service assembly.
- Follow installation procedures recommended by NEC and National Electrical Safety Code (NESC).

- Consider the location of electrical power service point as shown in the Plans to be approximate, and coordinate with the appropriate electrical power company authority to determine the exact locations of each service point.

- B. Provide a 2 inch PVC conduit with a minimum 24 inch bonding radius between the "Electric" pull box and the power company pole to provide for their installation of the DPX cable. Stub up next to the pole at 6 inches above final grade.

- C. Conduit: Securely attach all conduits to the pole or cabinet with a maximum distance of three feet between conduit attachment hardware.

D. Electrical Service Wire:

- Install the electrical service wire in a manner which will ensure that damage to the installation will not occur.

- Ensure that the service wire is of sufficient length after installation in the conduit to provide for attachment to the power company service and for termination within the cabinet for which power is required.

- E. Meter Socket: Securely fasten the meter base to the pole. Install pole mounted meter bases at a minimum height of 5-1/2 feet above grade when measured from the center of the meter ring.

F. Service Disconnect:

- Securely fasten the service disconnect to the pole, and electrically position the service disconnect between the service meter and the traffic control device cabinet to which electrical service is being supplied.

- Install pole mounted service disconnects a minimum of 8 feet above grade when measured from the bottom of the disconnect.

LATEST REVISION 07/20/15

TRAFFIC CONTROL EQUIPMENT STANDARDS AND SPECIFICATIONS



PWMM TRAFFIC SIGNALS AND SIGNS DIVISION  
1100 NW 36th STREET  
MIAMI, FLORIDA, 33166  
305.592.3880

DATE	BY	APPROVED BY:
10-20-15	DANIEL ORTIZ	FRANK WEA, P.E.
10-20-15	WALTER FERNANDEZ	

ELECTRICAL POWER SERVICE ASSEMBLY STANDARDS AND SPECIFICATIONS

SHEET NO. 639-2

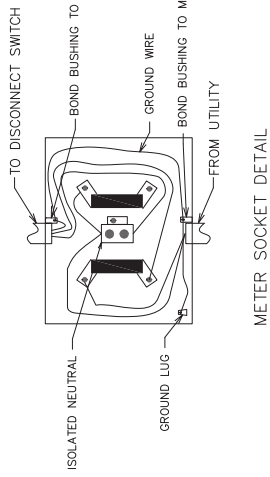
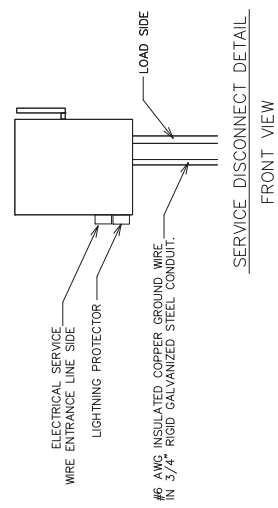
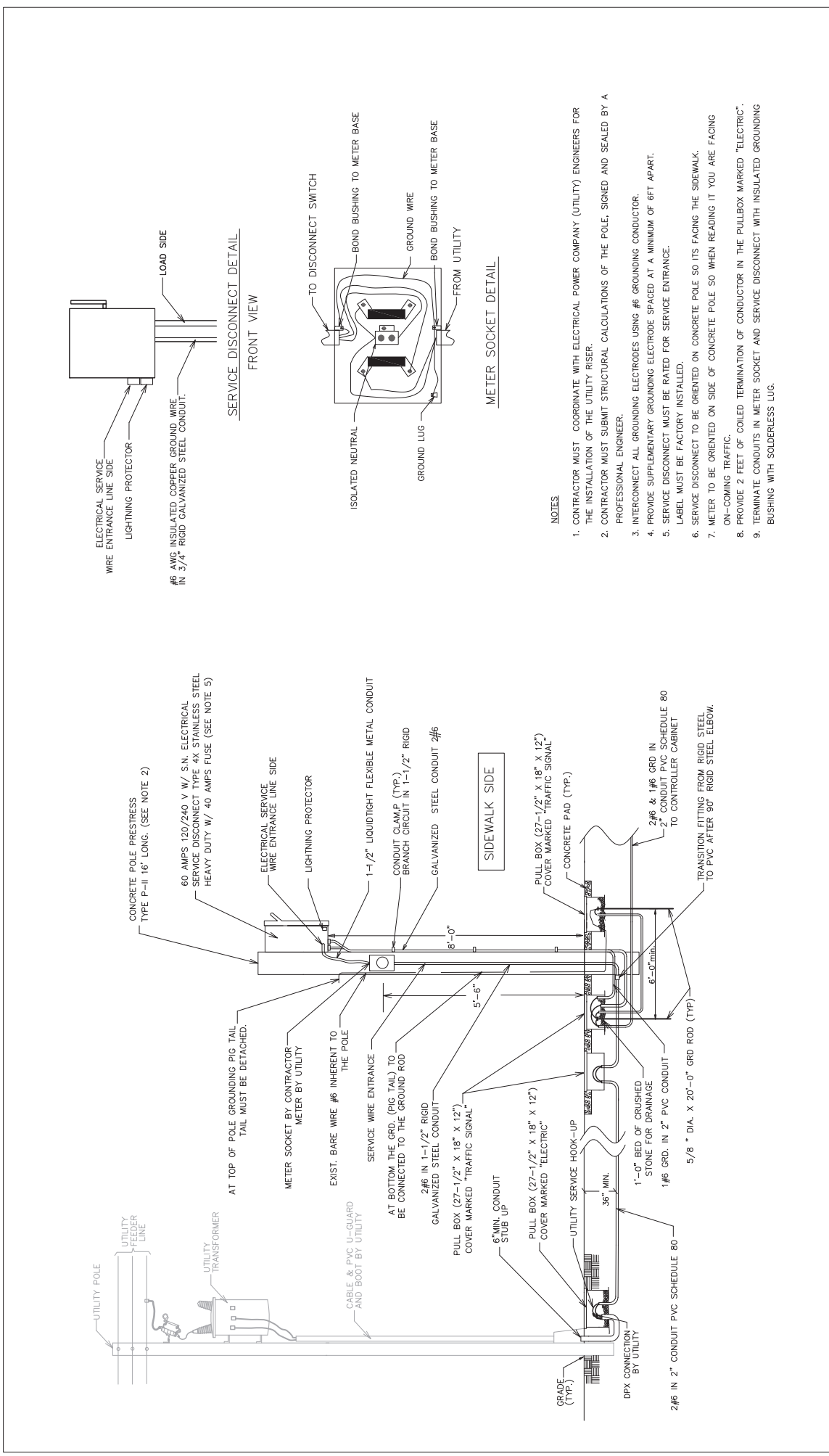

**NOTES**

1. CONTRACTOR MUST COORDINATE WITH ELECTRICAL POWER COMPANY (UTILITY) ENGINEERS FOR THE INSTALLATION OF THE UTILITY RISER.
2. CONTRACTOR MUST SUBMIT STRUCTURAL CALCULATIONS OF THE POLE, SIGNED AND SEALED BY A PROFESSIONAL ENGINEER.
3. INTERCONNECT ALL GROUNDING ELECTRODES USING #6 GROUNDING CONDUCTOR.
4. PROVIDE SUPPLEMENTARY GROUNDING ELECTRODE SPACED AT A MINIMUM OF 6FT APART.
5. SERVICE DISCONNECT MUST BE RATED FOR SERVICE ENTRANCE. LABEL MUST BE FACTORY INSTALLED.
6. SERVICE DISCONNECT TO BE ORIENTED ON CONCRETE POLE SO ITS FACING THE SIDEWALK.
7. METER TO BE ORIENTED ON SIDE OF CONCRETE POLE SO WHEN READING IT YOU ARE FACING ON-COMING TRAFFIC.
8. PROVIDE 2 FEET OF COILED TERMINATION OF CONDUCTOR IN THE PULLBOX MARKED "ELECTRIC".
9. TERMINATE CONDUITS IN METER SOCKET AND SERVICE DISCONNECT WITH INSULATED GROUNDING BUSHING WITH SOLDERLESS LUG.

DATE 08/31/15	SHEET NO. 639-3	DESCRIPTION	TRAFFIC CONTROL EQUIPMENT STANDARDS AND SPECIFICATIONS		PWSM TRAFFIC SIGNALS AND SIGNS DIVISION 7100 N.W. 36TH STREET MIAMI, FL 33166 305.592.2580	NAME	DATE
						DRAWN CHECKED APPROVED BY:	08-31-15 08-31-15 08-31-15

APPENDIX "J" TO SPECIAL PROVISIONS  
SECTION 641-PRESTRESSED CONCRETE POLES

**SECTION 641  
PRESTRESSED CONCRETE POLES**

**PART 1 GENERAL**

**1.01 SUMMARY**

**A. Description**

1. Furnish and install prestressed concrete poles pursuant to FDOT Specification Section 641 (Prestressed Concrete Poles) except as otherwise specified herein.

**B. Related Sections**

1. FDOT Specification Section 125 (Excavation for Structures and Pipe)
2. FDOT Specification Section 346 (Portland Cement Concrete)
3. FDOT Specification Section 347 (Portland Cement Concrete - Class NS)
4. FDOT Specification Section 450 (Precast Prestressed Concrete Construction)
5. FDOT Specification Section 620 (Grounding and Lightning Protection)
6. FDOT Specification Section 634 (Span Wire Assembly)
7. SECTION 639

**C. Method of Measurement**

1. Measurement for payment will be in accordance with the following work tasks:
  - a. Furnish and Install:
    - 1) The Contract unit price for prestressed concrete poles, furnish and install, will consist of the pole plus all labor, concrete when required for the foundation and other materials necessary for a complete and accepted installation as specified in the Contract Documents.
  - b. Pole Removal:
    - 1) Pole Removal Shallow: The quantity to be paid for will be the removal of each pole, including the foundation and all accessories and attachments, to a depth of not less than 4 feet below existing grade.
    - 2) Pole Removal Deep: The quantity to be paid for will be the complete removal of the pole, foundation and all accessories and attachments.

**D. Basis of Payment**

1. Price and Payment under the applicable pay item below will be full compensation for all work specified in this Section.
2. Payment will be made under:

Item No.	Description	Unit
641-2-11	Prestressed Concrete Pole, F&I, Type P-II Pedestal	EA

641-2-12M	Prestressed Concrete Pole, F&I, Type P-II Service (16 feet)	EA
641-2-60	Prestressed Concrete Pole, Complete Pole Removal- Pedestal/Service Pole	EA
641-2-70	Prestressed Concrete Pole, Shallow Pole Removal- Pole 30' and Greater	EA
641-2-80	Prestressed Concrete Pole, Complete Pole Removal- Pole 30' and Greater	EA

## **1.02 SUBMITTALS**

### **A. Product Data**

1. Provide pole design details and supporting calculations signed and sealed by a Florida Registered P.E. certifying that the pole meets applicable specification for intended signals application.

## **PART 2 PRODUCTS**

### **2.01 POLE FOR TRAFFIC SIGNAL ELECTRICAL POWER SERVICE ASSEMBLY**

- A. Each traffic signal electrical power service assembly pole must be a Type P-II Service Prestressed Concrete Pole meeting the requirements of FDOT Design Standards Index No. 17725 except that its overall length must be 16 feet (10 feet above final grade location and 6 feet below grade) and be listed on the Miami-Dade County Traffic Signals and Signs Division's Qualified Products List.

## **PART 3 EXECUTION**

### **3.01 NONE**

APPENDIX "K" TO SPECIAL PROVISIONS  
SECTION 654- RECTANGULAR RAPID FLASHING BEACONS

**SECTION 654  
RECTANGULAR RAPID FLASHING BEACONS**

**PART 1 GENERAL**

**1.01 SUMMARY**

**A. Description**

1. Furnish and install Rectangular Rapid-Flashing Beacon (RRFB) assemblies meeting the requirements of this Specification; the accompanying RRFB Assembly Standard Details; the Federal Highway Administration (FHWA) Interim Approval for Optional Use of Pedestrian Actuated RRFB at Uncontrolled Marked Crosswalks (IA-21) dated March 20, 2018 (with correction issued 3/21/2018); and the Plans.

**B. Related Sections**

1. FDOT Specification Section 620 (Grounding and Lightning Protection)
2. FDOT Specification Section 676 (Controller Cabinets)
3. FDOT Specification Section 700 (Highway Signing)

**C. Method of Measurement**

1. General: Unless otherwise specified herein, midblock crosswalk assemblies must include all materials, equipment, and labor necessary for a complete, functional and accepted installation.
2. Rectangular Rapid Flashing Beacon Assembly: The RRFB sign assembly includes the rectangular beacons, signs, sign support structure, cabinet, electronics, conduit, pull box, wiring, grounding, pedestrian pushbutton and all necessary appurtenances needed to meet the requirements of these Specifications. In addition:
  - a. Solar powered assembly: Includes solar panels and all components for a complete solar powered installation.
  - b. AC powered assembly: Does not include the cost of the Electrical Power Service Assembly.

**D. Basis of Payment**

1. Price and Payment will be full compensation for all work specified in this Section.
2. Payment will be made under:

Pay Item	Description	Unit
654-2-12	Rectangular Rapid Flashing Beacon, Furnish & Install- AC Powered, Complete Assembly- Back To Back	AS
654-2-22	Rectangular Rapid Flashing Beacon, Furnish & Install - Solar Powered, Complete Assembly - Back To Back	AS

**1.02 SYSTEM DESCRIPTION**



- A. Design and Performance Requirements for RRFB Assembly
1. Design Wind Speed: 150 mph
    - a. Manufacturer must provide engineering certification that the RRFB assembly's major components along with the recommended attachments for mounting on a 4.5" outer diameter pole, meet the load requirements of Section 3 of AASHTO LTS-6 as modified by FDOT Structures Manual Volume 3 using a Basic Wind Speed (V) of 150 mph in the determination of the design wind pressure.
    - b. Engineer of Record must ensure that the proposed sign assemblies and foundation are designed to withstand all applicable wind loads.
  2. The duration of a predetermined period of operation of the RRFBs following each actuation should be based on the procedures provided in Section 4E.06 of the 2009 MUTCD for the timing of pedestrian clearance times for pedestrian signals. The required duration period for each crosswalk must be shown in the Plans and record documents.
  3. Meet all Conditions of FHWA Interim Approval (IA-21) as further specified below:
    - a. Unless otherwise specified herein, all RRFB sign assemblies must be double-sided and include a RRFB LED light bar on each side of the sign assembly between the bottom of the fluorescent yellow-green W11-2 (Pedestrian), S1-1 (School), or W11-15 (Trail) crossing warning sign and the top of the supplemental diagonal downward arrow (W16-7p) plaque. Double-sided sign assemblies at crosswalks located on one-way roads do not require the additional RRFB LED light bar on the side opposite the approach of traffic.
    - b. Each assembly must have an ADA compliant pedestrian pushbutton (except for an RRFB installed in advance of the crosswalk having an AHEAD plaque) that meets the requirements of IA-21 and:
      - 1) Provides a volume-controlled verbal message "Yellow Lights are Flashing" that is repeated for the duration of flashing and a locator tone that repeats every four seconds when the beacons are dark.;
      - 2) Includes a R10-25 (PUSH BUTTON TO TURN ON WARNING LIGHTS) sign mounted adjacent to or integral with each pedestrian pushbutton explaining the purpose and use of the pedestrian pushbutton detector; and is
      - 3) Positioned per the details that accompany these Specifications.
  4. Unless otherwise shown in the Plans and approved by Engineer, the RRFB assembly, its components, and signs must be U-bolt mounted on a Miami-Dade County TSSQPL approved 4-1/2 inches outer diameter (4 inch nominal) threaded aluminum pedestal pole and square aluminum break away base with a reinforcing collar assembly. Attachment hardware must meet or exceed the requirements of the Florida Department of Transportation (FDOT) Standard Plans, Index No. 700-010.
  5. Unless approved otherwise, provide a suitable surge protection device (SPD) that meet the requirements of FDOT Specification Section 620.
  6. The individual RRFB components must be replaceable independently of other components and be equipped with approved terminal strips or wire-end molded connectors.
  7. RRFB must be capable of being readily reprogrammed in the field in order to support future changes in MUTCD or FDOT requirements.
  8. Certification of Compliance from a third party accredited laboratory, certifying compliance with the required minimum Class 1 yellow peak luminous intensity, must be provided upon request.

### 1.03 WARRANTY

#### A. Special Warranty

1. Ensure the midblock crosswalk enhancement assembly has a manufacturer's warranty covering defects for three years from the date of final acceptance in accordance with Section 600. Ensure the warranty includes providing replacements within 10 calendar days of notification for defective parts and equipment during the warranty period at no cost to the Department.

## PART 2 PRODUCTS

### 2.01 MATERIALS AND EQUIPMENT

- A. RRFB assembly and components must be listed on the FDOT APL and the Miami-Dade County TSSQPL.
- B. Aluminum materials must meet the requirements of the Aluminum Association Alloy 6061-T6 (ASTM B209, B221, B308 or B429), except as noted.
- C. Cabinets, Housings, and Hardware: Cabinets used as part of the midblock crosswalk enhancement assembly must meet the applicable criteria of FDOT Section 676.
- D. All housings other than approved cabinets must be powder coat painted dull black (Federal Standard 595A-37038) with a reflectance value not exceeding 25 percent as measured by American Society for Testing and Material E1347. Cabinets and housings must prevent unauthorized access.
- E. Ensure all assembly hardware, including nuts, bolts, external screws and locking washers less than 5/8 inch in diameter, are Type 304 or 316 passivated stainless steel. Stainless steel bolts, screws, and studs must meet ASTM F593. Stainless steel nuts must meet ASTM F594. All assembly hardware greater than or equal to 5/8 inch in diameter must be galvanized. Carbon steel bolts, studs, and threaded rod must meet ASTM A307. Structural bolts must meet ASTM A325.
- F. Electrical Specifications:
  1. Equipment must operate on solar power or a nominal voltage of 120 volts alternating current ( $V_{AC}$ ). If the device requires operating voltages of less than 120  $V_{AC}$ , supply the appropriate voltage converter.
  2. Solar powered systems must be designed to provide a minimum of 10 days of continuous operation without sunlight. Solar powered systems must automatically charge batteries and prevent overcharging and over-discharging. Solar powered systems must include a charge indicator and AC/DC battery charger.
  3. Ground and bond assemblies in accordance with the accompanying standard details and per NEC and FDOT Specification Section 620 requirements.
  4. Conduits must meet the requirements of Miami-Dade County TCESS Section 630 (Conduit).
  5. Pullboxes must meet the requirements of Miami-Dade County TCESS Section 635 (Pull, Splice, and Junction Boxes).

- 6. Electrical power assembly must meet the requirements of Miami-Dade County TCESS Section 639 (Electrical Power Service Assembly).
  
- G. Environmental Specifications: All electronic assemblies shall operate as specified during and after being subjected to the transients, temperature, voltage, humidity, vibration, and shock tests described in National Electrical Manufacturers Association (NEMA) TS2, 2.2.7, 2.2.8, and 2.2.9. Electronics must meet Federal Communications Commission (FCC) Title 47, Subpart B, Section 15.

## **PART 3 EXECUTION**

### **3.01 REPAIRS/RESTORATION**

- A. Restore any areas impacted by the installation of the crosswalk enhancement assembly to original condition unless otherwise shown in the Plans. Install crosswalk enhancement assembly in accordance with the Americans with Disabilities Act Standards for Transportation Facilities.

END OF SECTION 654

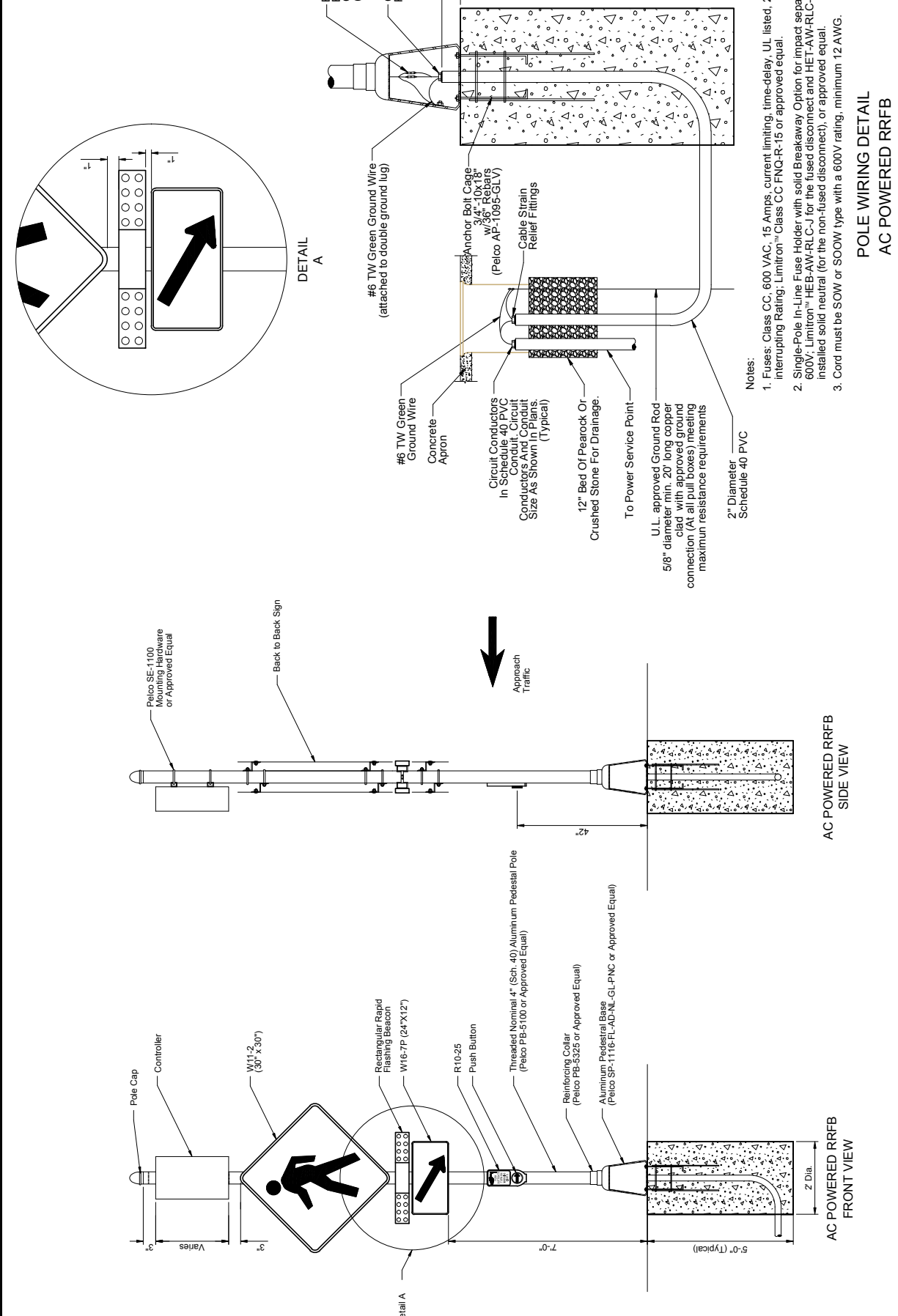

DATE	BY	CHKD	DATE	BY	CHKD	DATE	BY	CHKD
04-27-18			04-27-18			04-27-18		

NAME	DATE	NAME	DATE
ERNEST ESTRINE	04-24-18	MARK	04-27-18
MIAMI TERRANCE	04-24-18		

DESCRIPTION	DATE
W11-2 (30" X 30")	
Rectangular Rapid Flashing Beacon W16-7P (24" X 12")	
R10-25 Push Button	
Threaded Nominal 4" (Sch. 40) Aluminum Pedestal Pole (Pelco PB-5100 or Approved Equal)	
Reinforcing Collar (Pelco PB-5325 or Approved Equal)	
Aluminum Pedestal Base (Pelco SP-1116-FL-AD-NL-GL-PNC or Approved Equal)	

DATE	BY	CHKD	DATE	BY	CHKD
04-27-18			04-27-18		

DATE	NAME	DATE	NAME
04-27-18	MIAMI-DADE	04-27-18	MIAMI-DADE

DESCRIPTION	DATE
DTPW TRAFFIC SIGNALS AND SIGNS DIVISION	
7100 NW 36TH STREET	
MIAMI, FLORIDA, 33166	
305-592-3580	

SHEET NO.	DATE
654-1	04-27-18



DETAIL A

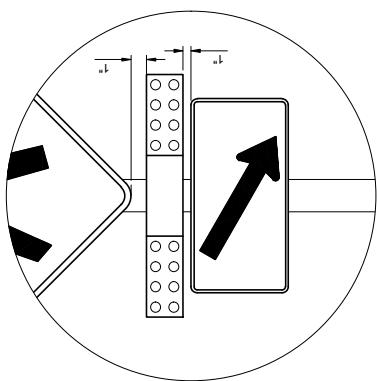

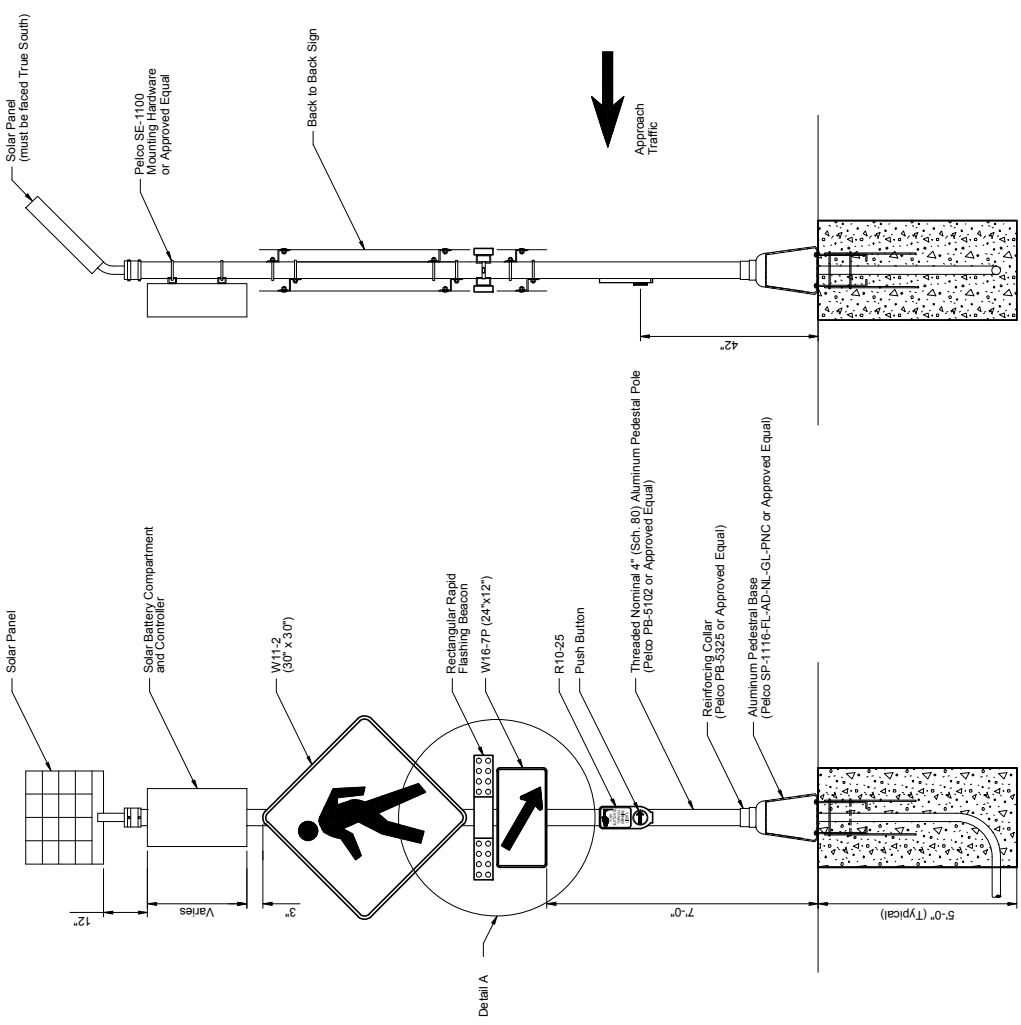
SOLAR POWERED RRFB FRONT VIEW

SOLAR POWERED RRFB SIDE VIEW

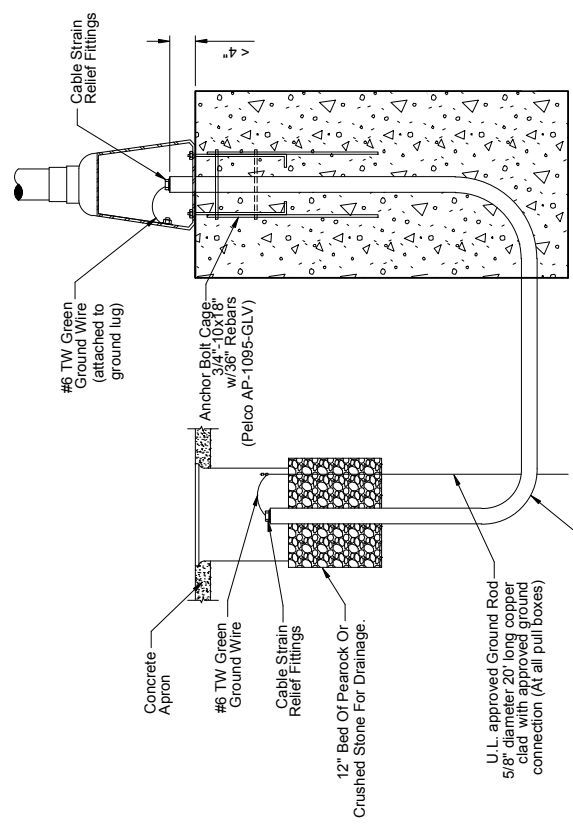

POLE GROUNDING DETAIL SOLAR POWERED RRFB

DATE		DATE		DATE		DATE	
04/27/18	04/27/18	02-24-18	02-24-18	02-24-18	02-24-18	02-24-18	02-24-18
TEST REVISION	DATE	NAME	DATE	NAME	DATE	NAME	DATE
		ERNESTO ESTRADA	02-24-18	ERNESTO ESTRADA	02-24-18	ERNESTO ESTRADA	02-24-18
		MIAMI-DADE		MIAMI-DADE		MIAMI-DADE	
DESCRIPTION:		DTPW TRAFFIC SIGNALS AND SIGNS DIVISION					
		7100 NW 36th STREET					
		MIAMI, FLORIDA, 33166					
		305.592.3980					
		APPROVED BY: FRANK ANA, P.E.					
RECTANGULAR RAPID FLASHING BEACONS (SOLAR POWERED) DETAILS (N.T.S.)		SHEET NO.		654-2			

T:\usdr\Project (2018)\RECTANGULAR RAPID FLASHING BEACONS (SOLAR POWERED)DETAILS.dwg - 4/27/2018 2:22:50 PM DWG To PDF.plt

APPENDIX "L" TO SPECIAL PROVISIONS  
SECTION 660-VEHICLE DETECTION SYSTEM

**SECTION 660  
VEHICLE DETECTION SYSTEM**

**PART 1 GENERAL**

**1.01 SUMMARY**

**A. Description**

1. Furnish and install vehicle detection system in accordance with the Contract Documents. Use only vehicle detection systems that meet the requirements of this Specification and are listed on the FDOT's Approved Products List (APL) and the Department's Traffic Signals and Signs Division's Qualified Products List (TSSQPL).

**B. Method of Measurement**

**1. Furnish and Install:**

**a. Inductive Loops**

- 1) The Contract unit price for each Inductive Loop Detector furnished and installed at the traffic signal cabinet includes all labor, equipment, testing and configuration necessary for a complete and accepted installation.
- 2) The Contract unit price for each Loop Assembly, furnished and installed, will include all equipment, labor, equipment, and materials necessary for a complete and accepted installation of the entire loop assembly as specified in the Contract Documents including the shielded lead-in cable into the traffic signal cabinet, proper termination, and testing.

**b. Microwave Vehicle Detection System**

- 1) The Contract unit price for Microwave Vehicle Detection System (MVDS), Cabinet Equipment, furnished and installed, includes all materials, tools, labor, equipment, approved mounts and hardware, operational software packages and firmware, supplies, support, testing, calibration, personnel training, shop drawings, warranty documentation, and incidentals necessary to complete the MVDS installation at each traffic signal cabinet location.
- 2) The Contract unit price for Microwave Vehicle Detection System (MVDS), Above Ground Equipment, furnished and installed, includes all materials, tools, labor, equipment, approved mounts and hardware, routing of cables and wiring properly terminating inside the traffic signal cabinet, operational software packages and firmware, supplies, support, testing, calibration, personnel training, shop drawings, warranty documentation, and incidentals necessary to complete the above ground MVDS work for each intersection approach.

**c. Video Vehicle Detection System**

- 1) The Contract unit price for Video Vehicle Detection System (VVDS), Cabinet Equipment, furnished and installed, includes all materials, tools, labor, equipment, approved mounts and hardware, operational software packages and firmware, supplies, support, testing, calibration, personnel training, shop drawings, warranty documentation, and incidentals necessary to complete the VVDS installation at each traffic signal cabinet location.

- 2) The Contract unit price for Video Vehicle Detection System (VVDS), Above Ground Equipment, furnished and installed, includes all materials, tools, labor, equipment, approved mounts and hardware, routing of cables and wiring properly terminating inside the traffic signal cabinet, operational software packages and firmware, supplies, support, testing, calibration, personnel training, shop drawings, warranty documentation, and incidentals necessary to complete the above ground VVDS work for each camera.

d. Wireless Magnetometer Detection System

- 1) The Contract unit price for a Wireless Magnetometer Detection System (WMDS), Cabinet Equipment, furnished and installed, will include furnishing, placement, and testing of all materials and equipment, and for all tools, labor, equipment, hardware, operational software packages and firmware, supplies, support, personnel training, shop drawings, warranty documentation, and incidentals necessary to complete the work at each interection.
- 2) The Contract unit price for a Wireless Magnetometer Detection System (WMDS), Above Ground Equipment, furnished and installed, includes all materials, tools, labor, equipment, approved mounts and hardware, routing of cables and wiring properly terminating inside the traffic signal cabinet, operational software packages and firmware, supplies, support, testing, calibration, personnel training, shop drawings, warranty documentation, and incidentals necessary to complete the above ground WMDS work for each intersection.
- 3) Separate payment will be made for each magnetometer in-road device furnished and installed in conjunction with the WMDS installation, pursuant to the Contract Documents, and approved locations depicted on the Plans.

e. Automatic Vehicle Identification

- 1) The Contract unit price for a complete Automatic Vehicle Identification (AVI) detection system, furnished and installed, will include furnishing, placement, and testing of all materials and equipment, and for all tools, labor, equipment, hardware, operational software packages and firmware, supplies, support, personnel training, shop drawings, warranty documentation, and incidentals necessary to complete the work at each location.

C. Basis of Payment

- 1. Price and Payment under the applicable pay item below will be full compensation for all work specified in this Section.
- 2. Payment will be made under (Pay Items Numbers for Department Contracts to be determined by the Contracts and Specifications Section):

Item No.	Description	Unit
660-1-109C	Inductive Loop Detector, F&I	EA
660-2-106	Loop Assembly, F&I, Type F	AS
660-2-106M	Loop Assembly, F&I, Type F Modified (Bicycle)	AS
660-3-11	Vehicle Detection System- Microwave, F&I Cabinet Equipment	EA
660-3-12	Vehicle Detection System- Microwave, F&I Above Ground Equipment	EA
660-4-11	Vehicle Detection System- Video, F&I Cabinet	EA



	Equipment	
660-4-12	Vehicle Detection System- Video, F&I Above Ground Equipment	EA
660-5-11	Vehicle Detection System- Wireless Magnetometer, F&I, Cabinet Equipment	EA
660-5-12	Vehicle Detection System- Wireless Magnetometer, F&I, Above Ground Equipment	EA
660-5-13	Vehicle Detection System- Wireless Magnetometer, F&I, In-Road Electronics	EA
660-6-120	Vehicle Detection System- Avi, Bluetooth, F&I, Complete System	EA

## 1.02 SYSTEM DESCRIPTION

### A. Classification of Types

#### 1. Functional Types

- a. Vehicle Presence Detection System: Vehicle presence detectors produce a corresponding output any time that a vehicle occupies the physical or virtual area of the detector.
- b. Traffic Data Detection System: Traffic data detectors provide presence, volume, occupancy, and speed data for the lanes they are configured to monitor.
- c. Probe Data Detection System: Probe data detection systems provide speed data and travel times for a road segment. Probe data detectors use automatic vehicle identification (AVI) technologies to establish a unique identifier for each vehicle they detect. This identifier is then transmitted to a central site where it can be matched to past or future detections of the same vehicle at different detector locations.

#### 2. Technology Types

- a. Inductive Loop Detection System: An inductive loop detection system uses a minimum of one inductive loop and loop detector. The system operates by energizing and monitoring wire embedded in the road surface to detect vehicle presence and provide an output to traffic controllers or other devices that can generate volume, occupancy, and speed data (detection output).
- b. Video Vehicle Detection System (VVDS): A VVDS uses one or more cameras and video analytics hardware and software to detect vehicle presence, provides a detection output, and generates volume, occupancy, and speed data.
- c. Microwave Vehicle Detection System (MVDS): A MVDS transmits, receives, and analyzes a FCC-certified, low-power microwave radar signal to detect vehicle presence, provide a detection output, and generate volume, occupancy, and speed data.
- d. Wireless Magnetometer Detection System (WMDS): A WMDS uses one or more battery-powered wireless sensors embedded in the road surface, which communicates data by radio to a roadside receiver. Wireless magnetometer systems detect vehicle presence and provide a detection output to traffic controllers or other devices that can generate volume, occupancy, and speed data.
- e. Automatic Vehicle Identification (AVI): AVI detection systems use one or more different methods to collect information that can be used to establish a unique

identifier for each vehicle detected and the time and location that the vehicle was detected. AVI detection systems collect data using probe detectors that utilize radio-frequency identification (RFID), optical character recognition, magnetic signature analysis, laser profiling, Bluetooth®, or other technologies to establish vehicle identifier, time, and location.

**B. Design Requirements**

1. Provide stop bar detection in all lanes to provide a detection system that is capable of supporting a fully-actuated intersection and meet the requirements of the standard details for vehicle detection of the Miami-Dade County Traffic Control Equipment Standards and Specifications.
2. Use Inductive Loop Detection System technology type unless an alternate technology described herein is demonstrated by the Engineer of Record to be more suitable and reliable for the intersection under design. Written Department approval is required for use of detection technologies other than inductive loops.
3. Vehicle Detection Zones.
  - a. In addition to the Stop Bar Detection required by the standard details, the Department may approve the following general detection zones for use in a signal plan design where appropriate due to site-specific operational requirements:
    - 1) Queue Detection: Used on protected/permissive left turn lanes in addition to stop bar detection. Leading edge is placed at 50 feet from the Stop Bar.
    - 2) Long-Loop-Occupancy Detection: Used in each through lanes on very low-speed (25 mi/h or less) approaches for signal green time extension. Provided by increasing the length of the Stop Bar inductive loop detection to 50 feet from the Stop Bar.
    - 3) Multiple-Point Detection: Used on through lanes to ameliorate dilemma zone problems through the strategic placement of multiple sensors at high-speed (greater than 40 mi/h) approaches to intersections controlled by actuated controllers. Design based on guidance provided in Chapter 4, of the FHWA Traffic Detector Handbook: Third Edition—Volume I Inductive-loop detector placement in multiple-point detection systems used to ameliorate effects of dilemma zones.

**1.03 WARRANTY**

- A. Ensure that vehicle detection and data collection systems have a manufacturer's warranty covering defects for a minimum of 5 years from the date of final acceptance by Engineer in accordance with the Contract Documents and Section 600. Ensure the warranty includes providing replacements, within 10 calendar days of notification, for defective parts and equipment during the warranty period at no cost to the County.

**PART 2 PRODUCTS**

**2.01 INDUCTIVE LOOP DETECTION SYSTEM**

**A. Materials.**

1. Use inductive loop detectors and loop sealant currently listed on the FDOT's APL and the Department's TSSQPL.

2. Inductive Loop Detector Units: Ensure loop detector units meet the requirements of NEMA TS-2-2016.
3. Loop Wire:
  - a. Use No. 14 AWG stranded copper wire with Type XHHW cross-linked polyethylene insulation and an additional outer sleeve composed of polyvinylchloride or polyethylene insulation that meets the requirements of International Municipal Signal Association (IMSA) 51-7.
  - b. The wire must have surface-printed information indicating the manufacturer ID and its NRTL listing (UL, CSA, etc.), the maximum rated voltage, AWG size, the proper type letter or letters for the type of wire or the IMSA specification number every 2 feet or less.
4. Shielded Lead-in Cable: Use No. 14 AWG two conductor, stranded copper wire with shield and polyethylene insulation, meeting the requirements for IMSA 50-2.
5. Splicing Material:
  - a. Use rosin-core solder for soldered splices.
  - b. Butt-end connectors must be non-insulated Panduit Part Number BS14, BS10; Ideal Model Number TV16X, TV12X; Thomas and Betts Catalog Number BB-2, CC-2 or Engineer approved equivalent.
  - c. Insulated tubing used to cover splice must be heat-shrinkable, cross-linked polyolefin with a silicon sealant inside the tubing and an insulation rating of at least 600 V. Outer tubing must be dual/multiple wall type.
  - d. Splicing tape must be self-fusing silicone rubber.
6. Loop Sealant:
  - a. Ensure that loop sealant:
    - 1) Is manufactured for traffic loop embedding in both asphalt and concrete pavement.
    - 2) Consists of multi-component systems having simple mix ratios of 1:1 or 2:1 or are supplied in pre-measured containers in which all contents of both packages are to be mixed.
    - 3) Is self-leveling when applied.
    - 4) Does not run out of unlevel slots as tested for viscosity using ASTM D562 at 77°F.
    - 5) Is tack free within a maximum of 2 hours from time of application and when cured as tested for tack free time using ASTM C679 at 77°F.
    - 6) Securely adheres to concrete and asphalt when installed in a 3/8 inch by 3 inch saw cut, cured for 2 weeks at 77°F as tested for adhesion using visual inspection.
    - 7) Shows no visible signs of shrinkage after curing when installed in a 3/8 inch by 3 inch saw cut, cured for 2 weeks at 77°F as tested for shrinkage using a dimensional measurement.
    - 8) Resists weather, oils, gasoline, antifreeze, and brake fluid as tested for absorption using ASTM D570 for water, No. 3 oil, gasoline, antifreeze, and brake fluid for 24 hours.
    - 9) Resists penetration of foreign materials as tested for durometer hardness using ASTM D2240 Shore A for 24 hours.

- 10) Resists cracking caused by expansion and contraction due to temperature changes as tested for tensile strength and elongation using ASTM D412.
- 11) Does not become brittle with age or temperature extremes as tested for weight loss, cracking, and chalking using ASTM C1246.
- 12) Has a minimum shelf life of 1 year in undamaged containers when stored per manufacturer recommendations.

## 2.02 VIDEO VEHICLE DETECTION SYSTEM (VVDS)

### A. Configuration and Management:

1. Ensure that the VVDS:
  - a. Is provided with software that allows local and remote configuration and monitoring.
  - b. Can display detection zones and detection activations overlaid on live video inputs.
  - c. Allows a user to edit previously defined configuration parameters, including size, placement, and sensitivity of detection zones.
  - d. Retains its programming in nonvolatile memory.
2. Ensure that the detection system configuration data can be saved to a computer and restored from a saved file. Ensure that all communication addresses are user programmable.
3. Ensure that the detection system software offers an open Application Programming Interface (API) and software development kit available to the Department at no cost for integration with third party software and systems.

### B. Detection Camera: Provide a camera that is furnished or approved by the video detection system manufacturer.

### C. Machine Vision Processor: Ensure the VVDS includes a machine vision processor that allows video analysis, presence detection, data collection, and interfaces for inputs and outputs as well as storage and reporting of collected vehicle detection data.

### D. Video Inputs and Outputs: Ensure that analog video inputs and outputs utilize BNC connectors.

### E. Solid State Detection Outputs: Ensure outputs meet the requirements of NEMA TS2-2016, 6.5.2.26.

### F. Electrical Requirements: Ensure the system operates using a nominal input voltage of 120 volts of alternating current ( $V_{AC}$ ). Ensure that the system will operate with an input voltage ranging from 89 to 135 $V_{AC}$ . If a system device requires operating voltages other than 120 $V_{AC}$ , supply a voltage converter.

## 2.03 MICROWAVE VEHICLE DETECTION SYSTEM (MVDS)

- A. Ensure that MVDS used for stop bar intersection presence detection can detect vehicles throughout a minimum detection range of 6-140 feet from the sensor and are capable of detecting up to 10 lanes of traffic.

- B. Ensure that MVDS used for dilemma zone protection can detect vehicles throughout a minimum detection range of 50-600 feet from the sensor; can report the speed, range, and estimated time of arrival at the stop bar of each vehicle detected; and can provide contact closure outputs when a vehicle meeting user-defined alert criteria is detected.
- C. Ensure that sidefire MVDS sensors used for data collection have a minimum 200-foot range and the capability to detect 8 lanes of traffic.
- D. Configuration and Management:
  - 1. Ensure that the MVDS is provided with software that allows local and remote configuration and monitoring. Ensure that the system software can display detection zones and detection activations in a graphical format.
  - 2. Ensure that the MVDS allows a user to edit previously defined configuration parameters, including size, placement, and sensitivity of detection zones.
  - 3. Ensure that the MVDS retains its programming in nonvolatile memory. Ensure that the detection system configuration data can be saved to a computer and restored from a saved file. Ensure that all communication addresses are user programmable.
  - 4. Ensure that the detection system software offers an open API and software development kit available to the Department at no cost for integration with third party software and systems.
- E. Solid State Detection Outputs: Ensure outputs meet the requirements of NEMA TS2-2016, 6.5.2.26.
- F. Electrical Requirements: Ensure the microwave detector will operate with a nominal input voltage of 12 V<sub>DC</sub>. Ensure the microwave detector will operate with an input voltage ranging from 89 to 135 V<sub>AC</sub>. If any system device requires operating voltages other than 120 V<sub>AC</sub>, supply a voltage converter.
- G. Ensure that the detector is FCC-certified and that the FCC identification number is displayed on an external label. Ensure that the detector transmits within a frequency band of 10.525 gigahertz, plus or minus 25 megahertz, or another FCC-approved spectral band.

#### **2.04 WIRELESS MAGNETOMETER DETECTION SYSTEM (WMDS)**

- A. Configuration and Management:
  - 1. Ensure that the detection system is provided with software that allows local and remote configuration and monitoring.
  - 2. Ensure that the WMDS allows a user to edit previously defined configuration parameters.
  - 3. Ensure that the WMDS retains its programming in nonvolatile memory. Ensure that the detection system configuration data can be saved to a computer and restored from a saved file. Ensure that all communication addresses are user programmable.
  - 4. Ensure that the detection system software offers an open API and software development kit available to the Department at no cost for integration with third party software and systems.
- B. Solid State Detection Outputs: Ensure outputs meet the requirements of NEMA TS2-2016, 6.5.2.26.

- C. Electrical Requirements: Ensure the detection system will operate with an input voltage ranging from 89 to 135 V<sub>AC</sub>. If any system device requires operating voltages other than 120 V<sub>AC</sub>, supply a voltage converter.

## **2.05 AUTOMATIC VEHICLE IDENTIFICATION (AVI) DETECTION SYSTEM**

- A. Configuration and Management: Ensure that the detection system is provided with software that allows local and remote configuration and monitoring.
- B. Probe Detector Requirements:
  - 1. Transponder Readers: Ensure transponder readers are compatible with multiple tag protocols, including Allegro and the protocol defined in ISO18000-6B.
  - 2. Bluetooth Readers: Ensure that Bluetooth readers will operate using solar power and cellular communications. Ensure that Bluetooth readers will operate using power over Ethernet. Ensure that Bluetooth readers will operate with a nominal input voltage of 12 V<sub>DC</sub>.
  - 3. License Plate Readers: License plate readers must not require the use of visible strobes or other visible supplemental lighting.
- C. Electrical Requirements: Ensure the detection system will operate with an input voltage ranging from 89 to 135 V<sub>AC</sub>. If any system device requires operating voltages other than 120 V<sub>AC</sub>, supply a voltage converter.

## **2.06 COMMUNICATIONS**

- A. Communication requirements for VVDS, MVDS, WMDS and AVI:
  - 1. Ensure that the VVDS includes a minimum of one Ethernet communications interface. Ensure that components of the MVDS, WMDS and AVI detection system (such as sensors, controllers, and processing hardware) include a minimum of one serial or Ethernet communications interface.
  - 2. Ensure serial interfaces and connectors conform to applicable Telecommunications Industry Association (TIA) standards. Ensure that serial ports support data rates up to 115200 bps; error detection utilizing parity bits (i.e., none, even, and odd); and stop bits (1 or 2). MVDS sensors must a serial interface that supports RS-232 and RS-485.
  - 3. Ensure that wired Ethernet interfaces provide a 10/100 Base TX connection. Verify that all unshielded twisted pair/shielded twisted pair network cables and connectors comply with TIA-568.
  - 4. Ensure wireless communications are secure and that wireless devices are Federal Communications Commission (FCC) certified. Ensure that the FCC identification number is displayed on an external label and that all detection system devices operate within their FCC frequency allocation.
  - 5. Ensure cellular communications devices are compatible with the 4G system and cellular carrier used by the agency responsible for system operation and maintenance.
  - 6. Ensure the system can be remotely configured and monitored via one or more communications interface

## **2.07 MECHANICAL REQUIREMENTS FOR ALL DETECTORS**

- A. Ensure that all parts are made of corrosion-resistant materials, such as plastic, stainless steel, anodized aluminum, brass, or gold-plated metal.

- B. Ensure that all fasteners exposed to the elements are Type 304 or 316 passivated stainless steel.

## 2.08 ENVIRONMENTAL REQUIREMENTS FOR ALL DETECTORS

- A. Meet the environmental requirements of NEMA TS-2-2016.

## PART 3 EXECUTION

### 3.01 INSTALLATION

- A. Installation Requirements for all detectors:

1. Install, configure, and demonstrate a fully functional vehicle detection system, as shown in the plans. Connect all field equipment to the existing communication network, and provide all materials specified in the Contract Documents. Install all equipment according to the manufacturer's recommendations and these Specifications.
2. Mount above-ground detectors on existing poles or sign structures, or on new poles, as shown in the Plans. Furnish all equipment with the appropriate power and communication cables. Install the power cable and the communication cables according to the manufacturer's recommendation. Ensure that the cables comply with NEC sizing requirements and meet all other applicable standards, specifications, and local code requirements.
3. Do not install communication cables in the same conduit or pull boxes as power cables carrying voltage greater than 24 V<sub>DC</sub>/V<sub>AC</sub> or current in excess of 1.5 amps.
4. Cut cabinet wiring to the proper length. Do not double back wire to take up slack. Neatly lace wires into cables with nylon lacing or plastic straps. Secure cables with clamps and provide service loops at all connections.
5. In the event that power to the vehicle detection system or a subcomponent thereof is interrupted, ensure that the equipment automatically recovers after power is restored. Ensure that all programmable system settings return to their previous configurations and the system resumes proper operation.

- B. Inductive Loop Detector Installation:

1. Except as otherwise specified herein, install vehicle loops in accordance with the manufacturer's instructions, standard details for vehicle detection of the Miami-Dade County Traffic Control Equipment Standards and Specifications, and the Plans.
2. Unless otherwise specified in the Plans, stop bar loops in vehicular travel lanes must be thirty feet long Type F loops. Where specified in the Plans, a modified 3' x 20' Type F loop may be installed in dedicated bicycle lanes.
3. The leading edge of a loop cannot extend more than ten feet past the stop line.
4. The saw cut may not encroach into the crosswalk.
5. Inductive Loop-Detector Units: Adjust the operating frequency of each detector unit, if required, to prevent crosstalk of the units.
6. Saw Cuts:

- a. Saws must be equipped with a depth gauge to assist in maintaining proper depth and a horizontal guide to assure alignment.
  - b. Use a chalk line or equivalent method to outline the perimeter of the loop on the pavement and routes for lead-in cables. Do not allow the saw cut in the pavement to deviate by more than 1 inch from the chalked line.
  - c. Ensure that all saw cuts are free of any dust, dirt or other debris and completely dry prior to the installation of the loop wire, loop wire twisted pair lead or lead-in cable. Use compressed air to thoroughly dry the sawed slot.
  - d. Make saw cuts in accordance with standard details for vehicle detection of the Miami-Dade County Traffic Control Equipment Standards and Specifications unless otherwise stipulated in the Contract Documents.
  - e. Ensure that the top conductor of the loop wire or lead-in cable is a minimum of 2 inch below the final surface of the roadway.
7. Loop Wire:
- a. Ensure that the first turn of the loop wire is placed in the bottom of the saw cut, with each subsequent turn placed on top of the preceding turn. Push the loop wire to the bottom of the saw cut with a non-metallic tool which will not damage the insulation.
  - b. Label the loop wires in the pull box with waterproof tags and identify the start (S), finish (F) lead and the loop number.
  - c. Use alternate polarity on adjacent loops.
  - d. Hold the loop in place with strips of rubber, neoprene, flexible tubing, or foam backer rod as approved by Engineer. Ensure that the backer rod material is non-metallic, is placed in the saw slot using segments 1 to 2 inches long, spaced 12 inches apart, and that the distance from the top of the hold down material to the final surface of the roadway is not less than 1.5 inches.
8. Loop Wire Twisted Pair Lead:
- a. Create a loop wire twisted pair lead by twisting the loop wire pair a minimum of 10 turns per foot to form a loop wire twisted pair lead from the edge of the loop to the pull box located adjacent to the roadway. Place only one loop wire twisted pair lead in a saw cut. Ensure that the distance between a twisted loop wire pair lead within the roadway is a minimum of 6 inches from any other twisted loop wire pair lead or loop, until they are within 1 foot of the edge of pavement or curb, at which point they may be placed closer together.
  - b. Hold the loop wire twisted pair lead in place with strips of rubber, neoprene, flexible tubing, or foam backer rod as approved by Engineer. Ensure that the backer rod material is non-metallic, is placed in the saw slot using segments 1 to 2 inches long, spaced 24 inches apart, and that the distance from the top of the hold down material to the final surface of the roadway is not less than 1.5 inches.
  - c. Provide a minimum of 3 feet of twisted loop wire pair lead in the pull box located adjacent to the roadway. Do not route twisted loop wire pair lead directly through conduits to the cabinet, unless otherwise shown in the Plans.
9. Splicing:
- a. Splices must be made by crimping and soldering. Splice lead-in cable to the loop wire in accordance with these Specifications.
  - b. Perform the splicing in a pull box located off the roadway, not in the roadway itself. Splices must be made on the same day wires are installed unless the ends of the wires are sealed with Scotchkote to keep water out of the insulating jacket.



- c. Strip insulation of loop wires and lead-in cable as necessary. Clip one of the loop wires 3 inches shorter than other and clip the non-corresponding lead-in cable wire accordingly in order to stagger the splices.
  - d. Splice the black conductor of the lead-in cable to the finish (F) "lead" of the loop.
  - e. Crimp the appropriate wires with a non-insulated butt connector using a pressure crimping tool that provides a uniform 360-degree crimp. Insulate each wire splice separately using cross-linked polyolefin tubing.
  - f. Insulate the total splice using dual/multiple wall cross-linked polyolefin tubing.
  - g. Ensure that the ends of the cable jackets, twisted pair and lead-in, are encased in the loop splice material.
  - h. Ensure that each loop has an individual return to the cabinet and series splicing is performed on a separate terminal block in the cabinet.
10. Terminations:
- a. Using insulated terminal lugs, terminate lead-in cables or twisted pair loop wire on a terminal strip which is located in the controller or detector cabinet.
  - b. Use a calibrated ratchet type crimping tool to attach the lugs to the conductors of the lead-in cable or twisted loop wire.
11. Loop Sealant:
- a. Prepare the loop sealant in accordance with the manufacturer's instructions.
  - b. Using a manufacturer approved applicator or dispenser, apply only sufficient sealant to completely fill the saw cut without overfilling
  - c. Remove excess material from pavement.
  - d. Ensure that the loop sealant has cured completely before allowing vehicular traffic to travel over the sealant.
12. Loop Assembly Identification: Identify and tag each loop assembly in the controller or detector cabinet by lane and movement number.
- C. Video Detector Installation:
1. Install cameras and configure detection zones and settings in accordance with the Contract Documents, standard details for vehicle detection of the Miami-Dade County Traffic Control Equipment Standards and Specifications, manufacturer's recommendations, and as directed by Engineer.
  2. Submit configuration settings (including, but not limited to detector names, communication settings, and output assignments) and configuration file backups to Engineer.
  3. Submit a graphical depiction of each camera site, its pole location, mounting height, the ratio of distance away from the camera versus the mounting height, the camera's mounting type (i.e., pole or structure), camera aiming procedures, and the placement of the proposed detection zone for each lane.
  4. Do not use coaxial cable runs in excess of 500 feet. Mount and aim cameras in a manner that eliminates as much environmentally generated glare as possible.
  5. For systems where composite cables are used, Power over Ethernet (PoE) injectors are required for cable runs longer than 330 ft .
- D. Microwave Detector Installation:
1. Install detector and configure detection zones and settings in accordance with the Contract Documents, manufacturer's recommendations, and as directed by Engineer.

2. Submit configuration settings (including, but not limited to detector names, communication settings, and output assignments) and configuration file backups to Engineer.
- E. Wireless Magnetometer Installation:
1. Install in accordance with the Contract Documents, manufacturer's recommendations, and as directed by Engineer.
  2. Ensure that materials used for the installation of magnetometers in the road surface have cured completely before allowing vehicular traffic to travel over them.
- F. AVI Detection System Installation:
1. Install in accordance with the Contract Documents, manufacturer's recommendations, and as directed by Engineer.

### **3.02 INDUCTIVE LOOP PERFORMANCE REQUIREMENTS**

- A. Obtain latest Department's Loop Assembly Test Form from Engineer. Tests must be performed and the form completed and signed by a Contractor representative that is IMSA Traffic Signal Level II certified. Deliver the completed original to Engineer prior to Engineer's inspection and place a copy in the controller cabinet.
- B. Measure loop inductance, series resistance, insulation resistance, and quality factor. Take measurements both at the junction box (loop including twisted pair lead-in) and the Cabinet (loop and shielded lead-in cable). Measurements at the junction box must be taken before and after the loop wires are sealed in the pavement.
- C. Test Equipment. Conduct tests using one or more loop tester devices capable of measuring continuity, inductance in microhenrys ( $\mu\text{H}$ ), integrity of the wire insulation in mega-ohms ( $\text{M}\Omega$ ), loop wire resistance in ohms ( $\Omega$ ), and the Loop Quality Factor (Q).
- D. Inductive Loop Tester:
1. Measure inductance.
  2. Measure series resistance.
  3. Measure Loop Quality Factor.
- E. High voltage resistance tester:
1. Measure and record the insulation resistance (leakage to ground) of each loop assembly. Use a 500 VDC insulation megger to measure the resistance. Reference all measurements to a good earth ground (ground rod, metallic water pipe, etc.). Disconnect the transient suppression devices from the loop assemblies before taking any measurements.
- F. Acceptable test results.
1. Inductance (L): The inductance reading on the loop tester is within 10 percent of the Department's calculated value.
  2. Series resistance (R): Less than or equal to 10  $\Omega$  at the Controller.
  3. Loop Quality Factor (Q): Greater than 5.
  4. Insulation Resistance: Greater than 100  $\text{M}\Omega$ .

**G. Corrective Actions:**

1. Perform, at no additional cost to the Department and to the satisfaction of Engineer, all corrective actions necessary to obtain acceptable test results, as stipulated in the preceding Subarticle, and meet all requirements of these Specifications.
2. If the series resistance of a loop assembly is greater than 10  $\Omega$ , inspect the loop assembly to find the cause of the excessive resistance. Correct the cause of the excessive resistance at no additional cost to the Department.
3. If the insulation resistance is less than or equal to 100 M $\Omega$ , determine if the lead-in cable or the loop wire is causing the problem, and replace the defective cable or loop wire at no additional cost to the Department.

H. Turn On Requirements. Connect the loop assemblies to the appropriate inductive loop vehicle detectors and tune the detectors in accordance with the manufacturer's instructions. Separate the operating frequencies of vehicle detectors, in adjacent lanes, by at least 2 kHz.

**3.03 VEHICLE PRESENCE DETECTOR PERFORMANCE REQUIREMENTS****A. Vehicle Presence Detection System Field Acceptance Testing:**

1. Ensure presence detectors provide a minimum detection accuracy of 98%. Ensure presence detectors meet the requirements for modes of operation in NEMA TS2-2016, 6.5.2.17.
2. Verify detection accuracy at installed field sites using a reduced method to that described in FDOT Specification Section 660-2.2 (Vehicle Presence Detection Performance Requirements). Compare sample data collected from the detection system with ground truth data collected by human observation. For site acceptance tests, collect samples and ground truth data for each site for a minimum of five minutes during a peak period and five minutes during an off-peak period. For presence detection at intersections, ensure there are a minimum of three detections for each signal phase. Perform site acceptance tests in the presence of Engineer.

**3.04 TRAFFIC DATA DETECTOR PERFORMANCE REQUIREMENTS:****A. Traffic Data Detection System Field Acceptance Testing:**

1. Vehicle detection system must be capable of meeting the minimum total roadway segment accuracy levels of 95% for volume, 90% for occupancy, and 90% for speed for all lanes, up to the maximum number of lanes that the device can monitor as specified by the manufacturer.
2. Verify detection accuracy at installed field sites using a reduced method to that described in FDOT Specification Section 660-2.3 (Traffic Data Detection System Performance Requirements). Compare sample data collected from the detection system with ground truth data collected by human observation. For site acceptance tests, collect samples and ground truth data for each site for a minimum of five minutes during a peak period and five minutes during an off-peak period. Perform site acceptance tests in the presence of the Engineer.

**3.05 AVI DETECTION SYSTEM PERFORMANCE REQUIREMENTS:**

- A. AVI detectors must meet the performance requirements described in FDOT Specification Section 660-2.4 (Probe Data Detection Performance Requirements).

- B. Calculation of AVI Detection System Speed and Travel Time Accuracy: Calculate speed and travel time accuracy by comparing the speeds and travel times reported by the system against ground truth collected through human observation or another method approved by Engineer.

END OF SECTION 660

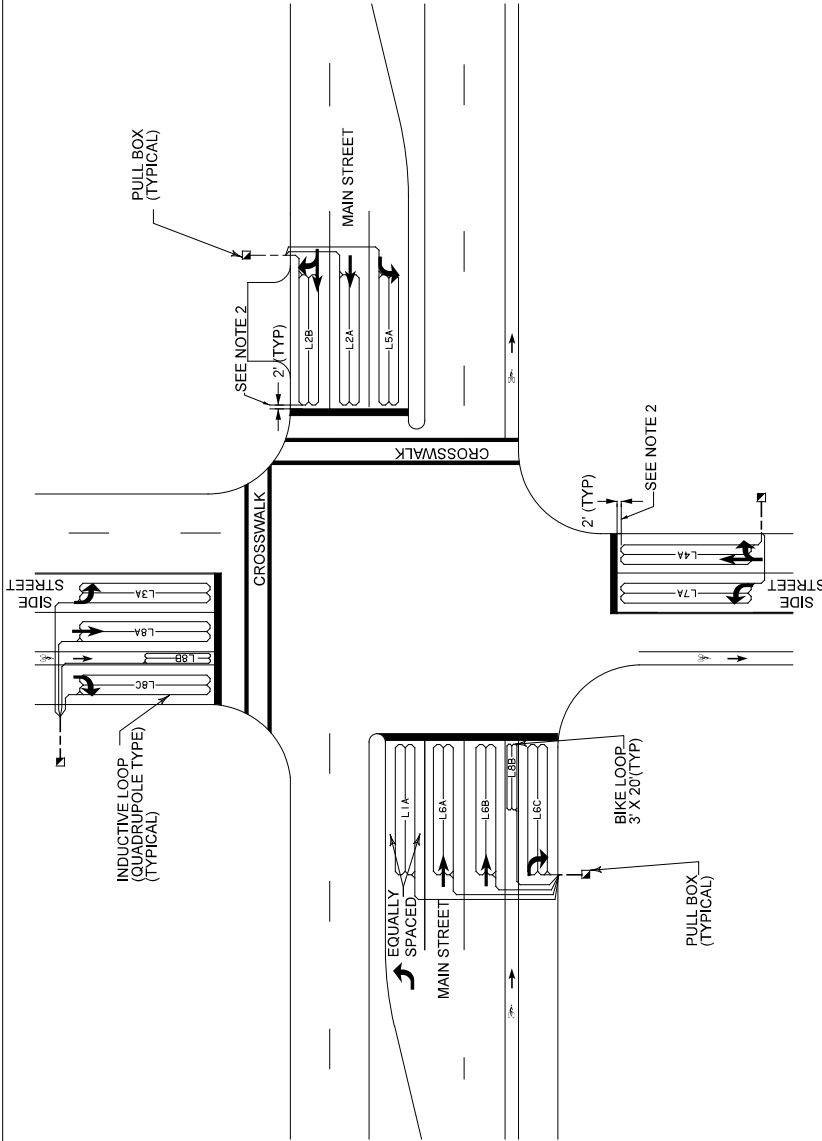

**TYPICAL INDUCTIVE LOOP PLACEMENT**

NOT TO SCALE

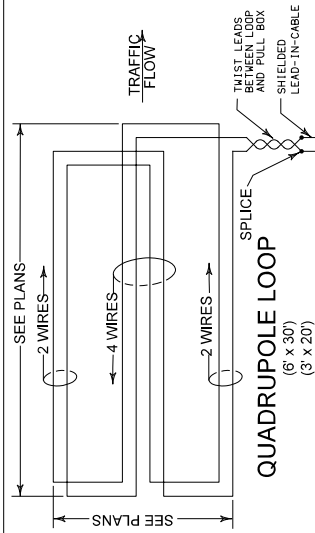

**TYPICAL DETECTOR LOOP WIRE CONFIGURATION**

NOT TO SCALE

OVERLAP SHALL BE CUT SO THAT SLOTS AT ALL CORNERS HAVE FULL DEPTH AND CUT DIAGONAL TO PREVENT SHARP BENDS IN LOOP WIRE.

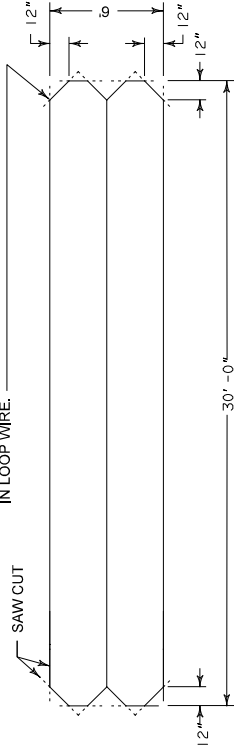

**TYPICAL "TYPE F" VEHICLE INDUCTIVE LOOP**

NOT TO SCALE

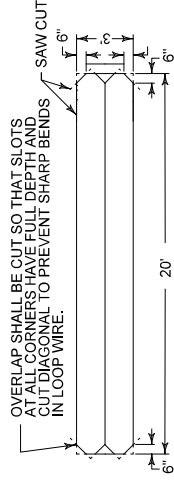

**TYPICAL "TYPE F" MODIFIED BICYCLE INDUCTIVE LOOP**

NOT TO SCALE

ROADWAY STRIPS OF RUBBER, NEOPRENE, FLEXIBLE TUBING OR FOAM BACKER ROD AS APPROVED BY THE ENGINEER LOOP SEALANT

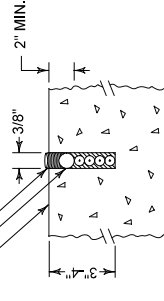

**LOOP SECTION**

NOT TO SCALE

**TYPICAL SAW CUT DETAIL**

DESIGN BY	TRAVIS BREWER	DATE	09-29-16
CHECKED BY	MIGUEL FERNANDEZ	DATE	10-22-17
APPROVED BY: FRANK ABEL, P.E.			

DTPW TRAFFIC SIGNALS AND SIGNS DIVISION  
700 NW 36th STREET  
MIAMI, FL 33136  
305.595.5300



TRAFFIC CONTROL EQUIPMENT STANDARDS AND SPECIFICATIONS

REVISION	03/27/17
----------	----------

TYPICAL INDUCTIVE LOOP INSTALLATION DETAILS (N.T.S.)

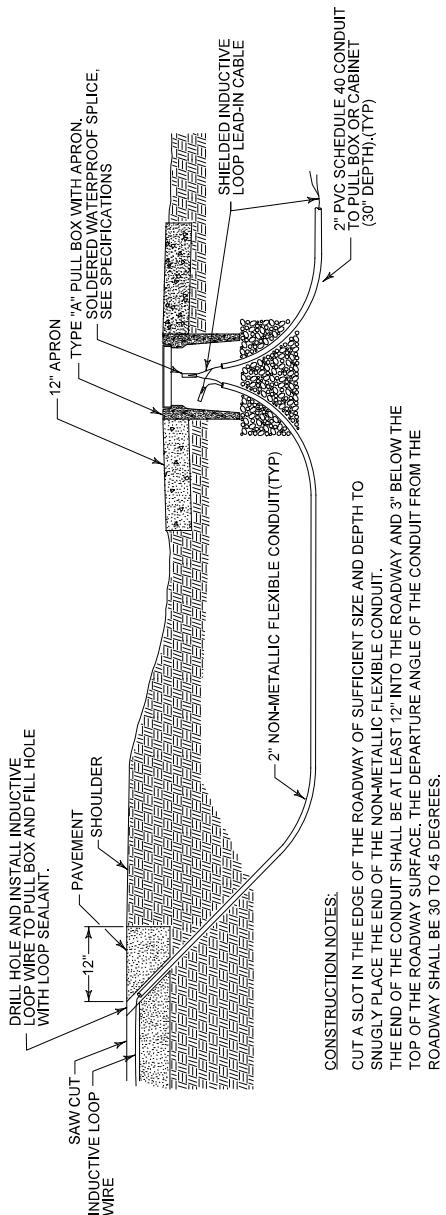

**CONSTRUCTION NOTES:**  
 CUT A SLOT IN THE EDGE OF THE ROADWAY OF SUFFICIENT SIZE AND DEPTH TO SNUGLY PLACE THE END OF THE NON-METALLIC FLEXIBLE CONDUIT. THE END OF THE CONDUIT SHALL BE AT LEAST 12" INTO THE ROADWAY AND 3" BELOW THE TOP OF THE ROADWAY SURFACE. THE DEPARTURE ANGLE OF THE CONDUIT FROM THE ROADWAY SHALL BE 30 TO 45 DEGREES.

**TYPICAL SECTION VIEW OF INDUCTIVE LOOP WIRE THROUGH PAVEMENT TO PULL BOX.**

NOT TO SCALE

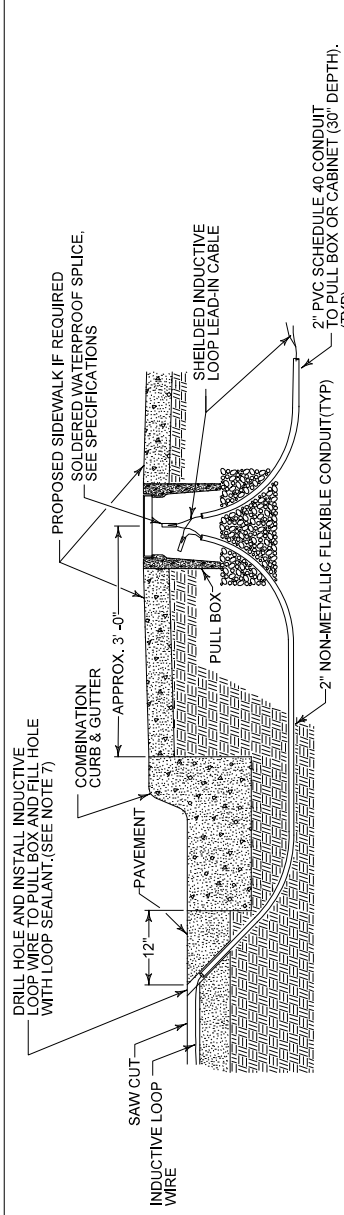

**CONSTRUCTION NOTES:**  
 DRILL A HOLE 1 1/2" TO 1" LARGER IN DIAMETER THAN THE FLEXIBLE CONDUIT TO BE USED THROUGH THE ROADWAY ASPHALT (OR CONCRETE) SURFACE AND BASE AT AN APPROPRIATE ANGLE TO INTERCEPT THE TRENCH OR PULL BOX HOLE. PLACE A PREDETERMINED LENGTH OF NON-METALLIC FLEXIBLE CONDUIT IN THE HOLE AND DRIVE THE CONDUIT INTO THE TRENCH OR HOLE. THE TOP OF THE CONDUIT SHALL BE APPROXIMATELY 3" BELOW THE ROADWAY SURFACE. FILL THE HOLE WITH LOOP SEALANT TO THE LEVEL OF THE ROADWAY SURFACE. A NONMETALLIC MATERIAL SHOULD BE USED TO PREVENT EXCESSIVE LOOP SEALANT FROM ENTERING THE NON-METALLIC FLEXIBLE CONDUIT.

**TYPICAL SECTION VIEW OF INDUCTIVE LOOP WIRE THROUGH CURB TO PULL BOX.**

NOT TO SCALE

**GENERAL NOTES:**

1. MEET THE REQUIREMENTS OF MIAMI-DADE COUNTY TRAFFIC CONTROL EQUIPMENT STANDARDS AND SPECIFICATIONS SECTION 660 (VEHICLE DETECTION SYSTEMS).
2. THE STANDARD PLACEMENT OF THE LEADING EDGE OF TYPE F LOOP IS TWO FEET BEFORE THE STOP BAR BUT MAY EXTEND A MAXIMUM OF 10 FEET PAST THE STOP BAR TO MEET SITE-SPECIFIC ENGINEERING REQUIREMENTS. EACH INTERSECTION MUST BE INDIVIDUALLY DESIGNED AND IF THE AFOREMENTIONED MODIFICATION IS REQUIRED IT MUST BE NOTED OR DETAILED IN THE PLANS UNDER NO CIRCUMSTANCES MAY THE LOOP OR SAW-CUT ENCROACH INTO A CROSSWALK.
3. IF THE LOOP LEAD-IN IS 75' OR LESS FROM THE EDGE OF THE LOOP DETECTOR TO CONTROLLER CABINET, CONTINUE THE TWISTED PAIR TO THE CABINET. IF THE LOOP LEAD-IN IS GREATER THAN 75' CONTINUE THE TWISTED PAIR TO THE SPECIFIED PULL BOX. SPLICE TO SHIELDED LEAD-IN WIRE AND CONTINUE TO THE CONTROLLER CABINET.
4. THE WIDTH OF ALL SAW CUTS SHALL BE SUFFICIENT TO ALLOW UNFORCED PLACEMENT OF LOOP WIRES OR LEAD-IN CABLES INTO THE SAW CUT. THE DEPTH OF ALL SAW CUTS, EXCEPT ACROSS EXPANSION JOINTS SHALL BE STANDARD 3 INCHES WITH A MAXIMUM OF 4 INCHES.
5. LOOP LEAD-IN WIRES MUST NOT BE INSTALLED IN THE SAME PULL BOX WITH SIGNAL POWER CABLES.
6. THE MINIMUM DISTANCE BETWEEN THE TWISTED PAIRS OF LOOP LEAD-IN WIRE IS 6 INCH FROM THE LOOP TO 12 INCH FROM THE PAVEMENT EDGE OR CURB.
7. THE MAXIMUM AREA OF ASPHALT TO BE DISTURBED SHALL BE 4'X 4". THIS AREA SHALL BE RESTORED AS DIRECTED BY THE ENGINEER.
8. LOOP LEAD-IN WIRES MUST BE 6 INCHES APART WHERE THERE ARE MULTIPLE LOOPS.

LATEST REVISION 03/27/17	DESCRIPTION	TRAFFIC CONTROL EQUIPMENT STANDARDS AND SPECIFICATIONS	 MIAMI-DADE TRAFFIC SIGNALS AND SIGNS DIVISION 145 N.W. 11th STREET MIAMI, FLORIDA 33136 305.592.3580	DATE	NAME	DATE
				02-22-11	BRUCE ESTERLINE	02-22-11
				APPROVED BY	FRANK ANA, P.E.	
TYPICAL INDUCTIVE LOOP INSTALLATION DETAILS (N.T.S.)						SHEET
						2 of 2

# TYPICAL VIDEO DETECTION CAMERA LOCATION DETAIL

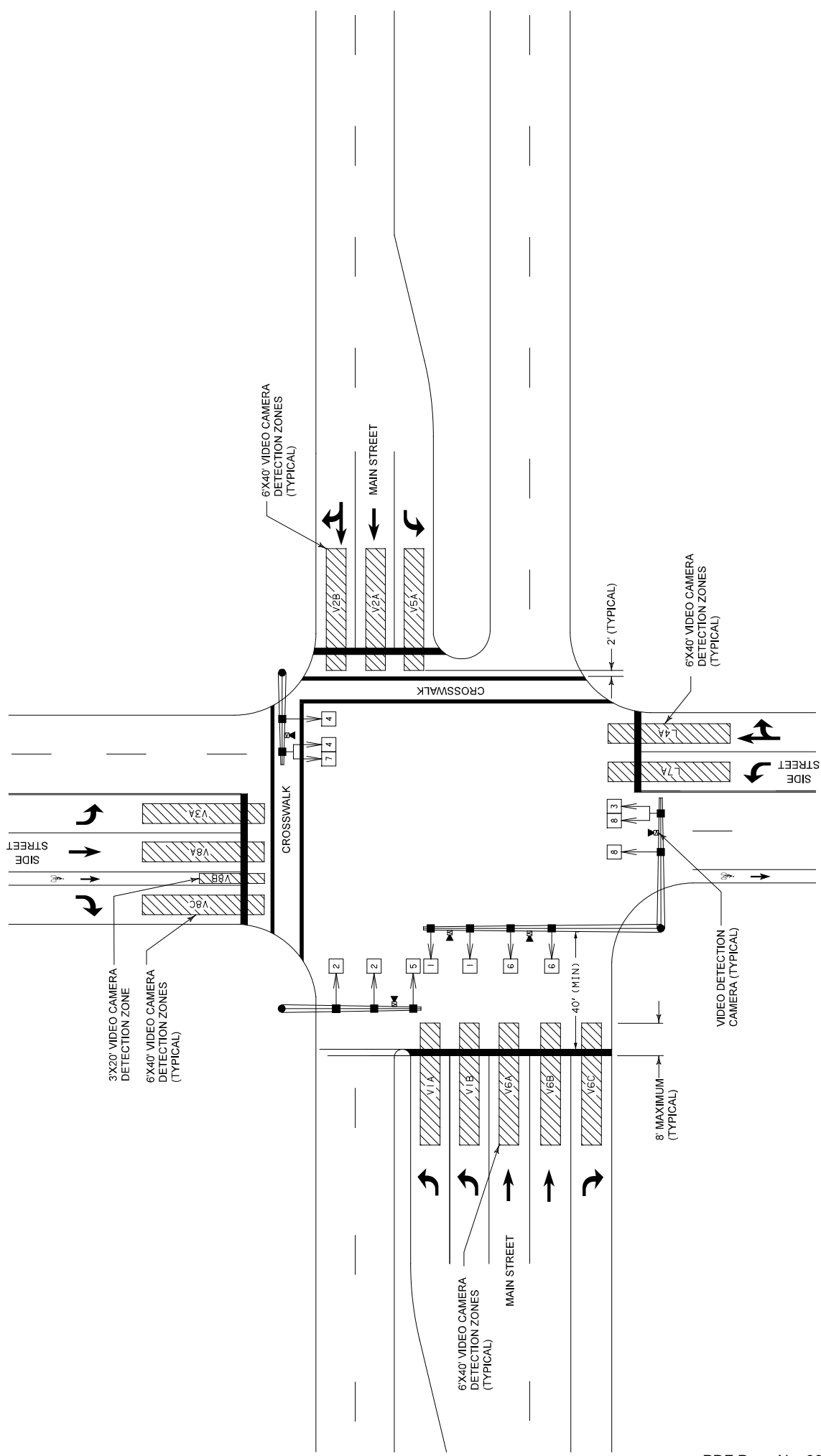

LATEST REVISION 03/27/17	DESCRIPTION: TRAFFIC CONTROL EQUIPMENT STANDARDS AND SPECIFICATIONS		DTPW TRAFFIC SIGNALS AND SIGNS DIVISION 700 NW 36th STREET MIAMI, FL 33136 305.492.3500	DRAWN BY: [blank] CHECKED BY: [blank]	NAME: TRAVIS BREWER	DATE: 03-29-16	SHEET 1 of 2
				APPROVED BY: FRANK AMAL, P.E.		VIDEO VEHICLE DETECTION DETAILS (N.T.S.)	

# TYPICAL MAST ARM VIDEO DETECTOR MOUNTING DETAILS

- GENERAL NOTES:
1. MEET THE REQUIREMENTS OF MIAMI-DADE COUNTY TRAFFIC CONTROL EQUIPMENT STANDARDS AND SPECIFICATIONS SECTION 660 (VEHICLE DETECTION SYSTEMS). EACH INTERSECTION MUST BE INDIVIDUALLY DESIGNED TO INCLUDE SITE-SPECIFIC EQUIPMENT PLACEMENT REQUIREMENTS AND DETECTION ZONE REQUIREMENTS.
  2. REFER TO FDOT'S APPROVED PRODUCT LIST (APL) AND THE MIAMI-DADE COUNTY TRAFFIC SIGNALS AND SIGNS DIVISION'S QUALIFIED PRODUCT LIST FOR VIDEO DETECTOR SYSTEMS AND MOUNTING HARDWARE APPROVED FOR USE IN MIAMI-DADE COUNTY. SUBMIT SHOP DRAWINGS FOR APPROVAL BEFORE INSTALLATION.
  3. TYPICAL INSTALLATION WILL REQUIRE ONE CAMERA PLACED ON THE LANE LINE BETWEEN THE INBOARD THROUGH LANE AND LEFT TURN LANE.
  4. APPROACHES WITH MORE THAN FOUR LANES REQUIRE TWO CAMERAS PER APPROACH. COUNT BICYCLE LANES AS HALF A LANE. WHEN USING TWO CAMERAS, PLACE ONE BETWEEN THE LEFT LANES AND THE OTHER IN A POSITION THAT CENTERS THE CAMERA TO COVER ALL THE THROUGH LANES. THE CAMERA MUST BE ORIENTED SO THAT THE STOP BAR IS PARALLEL WITH THE BOTTOM OF THE IMAGE.
  5. WHEN PROPOSED VIDEO DETECTION CAMERAS ARE LOCATED AT A HORIZONTAL DISTANCE FROM 40 TO 100 FEET FROM THE STOP BAR AND NUMBER OF APPROACH LANE EXCEEDS THREE (OR 33 FEET TOTAL WIDTH), INDIVIDUAL VIDEO CAMERAS MUST BE INSTALLED FOR EACH CONTROLLER TIMING FUNCTION.
  6. CHECK FOR ANYTHING THAT MIGHT BLOCK THE FIELD OF VIEW OR IMPACT VEHICLE TRACKING SUCH AS TREES, OVERHEAD WIRES, AND COMMERCIAL LIGHT SOURCES.
  7. REVIEW THE PLACEMENT OF THE VIDEO IMAGE DETECTION DEVICES AND COORDINATE WITH THE ENGINEER OF RECORD TO CONFIRM THE MOST OPTIMAL LOCATION FOR THE INSTALLATION OF THE VIDEO IMAGE DETECTION DEVICES IN ORDER TO MEET THE PERFORMANCE REQUIREMENTS OF THE TECHNICAL SPECIFICATIONS OF AN APPROVED PRODUCT.
  8. CONCEAL CAMERA CABLE(S) THROUGH THE MOUNT'S GUSSETED TUBE AND NEATLY PLACE DRIP LOOP INTO THE MAST ARM MINIMIZING EXPOSED CABLE(S). WIRE ACCESS HOLE MUST NOT EXCEED ONE INCH IN DIAMETER AND MUST INCLUDE A RUBBER GROMMET. DRILL HOLE AS TO NOT DAMAGE EXISTING SIGNAL CABLES. UTILIZE EXISTING ACCESS WHEREVER POSSIBLE.
  9. MEET ALL GROUNDING AND SURGE PROTECTIVE DEVICE (SPD) REQUIREMENTS OF SECTION 620 OF THE FDOT STANDARD SPECIFICATIONS.
  10. MAKE THE VIDEO DETECTION SYSTEM OPERATIONAL IMMEDIATELY UPON INSTALLATION. REMOVING THE ASSOCIATED MINOR MOVEMENTS FROM RECALL.
  11. ZOOM AND FOCUS THE CAMERA TO INCLUDE ALL TRAVEL LANES REQUIRING DETECTION. HORIZON MUST NOT BE VISIBLE IN THE IMAGE.
  12. ALL OSHA CLEARANCE REQUIREMENTS FOR MAINTAINING SAFE DISTANCES TO OVERHEAD ELECTRIC FACILITIES WHILE PERFORMING CAMERA MAINTENANCE SHALL BE ACHIEVED BY CORRECT CAMERA PLACEMENT, LOCATE AND ANGLE CAMERAS TAKING INTO CONSIDERATION ITS RELATION TO THE RISING AND SETTING SUN TO BEST AVOID "SUNBURST" AND "WHITEOUT" EFFECTS DEMONSTRATED ON WET ROADWAYS.
  13. ALL EXTERIOR VIDEO CABLE FITTINGS SHALL HAVE A WATER AND WEATHER-PROOF BOOT.
  14. CAMERA TERMINALS THAT REQUIRE CABLE SPLICING IN THE FIELD MUST BE MADE WITH MECHANIC CONNECTORS OR TERMINAL LUGS. NO ELECTRICAL WIRE NUTS WILL BE ALLOWED AS A MEANS OF TERMINATION.
  15. SIGNAL CONTRACTOR IS RESPONSIBLE FOR INITIAL DETECTION ZONE SET-UP. COORDINATE WITH MIAMI-DADE COUNTY PRIOR TO SET-UP.
  16. VIDEO DETECTION SET-UP WILL BE SUCH THAT NO FALSE OR DROPPED CALLS ARE OBSERVED.
  17. DETECTION ZONE OUTPUT MUST BE PROGRAMMED TO CALL APPROPRIATE TIMING PHASES ASSIGNED TO CAMERA APPROACH. ONE VIDEO PROCESSOR CARD PER CAMERA. ONE DETECTION ZONE PER LANE ON APPROACH.
  18. ALL MINIMUM REQUIREMENTS LISTED ABOVE MUST BE DEMONSTRATED PRIOR TO FINAL ACCEPTANCE OF ANY VIDEO DETECTION SYSTEM INSTALLATION.

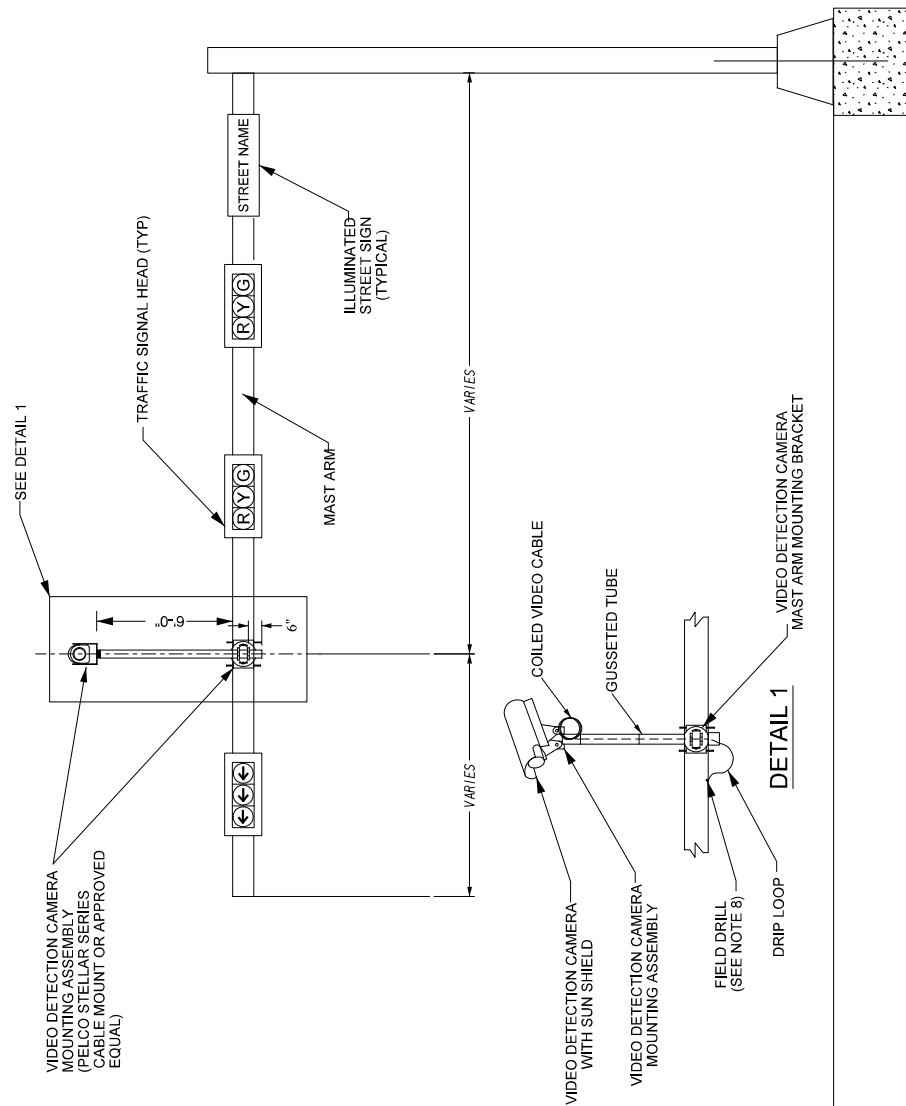

LATEST REVISION 03/27/17	DESCRIPTION: TRAFFIC CONTROL EQUIPMENT STANDARDS AND SPECIFICATIONS		DTPW TRAFFIC SIGNALS AND SIGNS DIVISION TRAFFIC SIGNALS MIAMI, FL 33146 305.592.5580	DRAWN: [ ] CHECKED: [ ]	NAME: [ ] TITLE: [ ] DESIGNED: [ ]	DATE: [ ] 03-29-16 03-22-17	SHEET: 2 OF 2
				VIDEO VEHICLE DETECTION DETAILS (N.T.S.)			



# TYPICAL AUTOMATIC VEHICLE IDENTIFICATION (BLUETOOTH) MOUNTING DETAILS

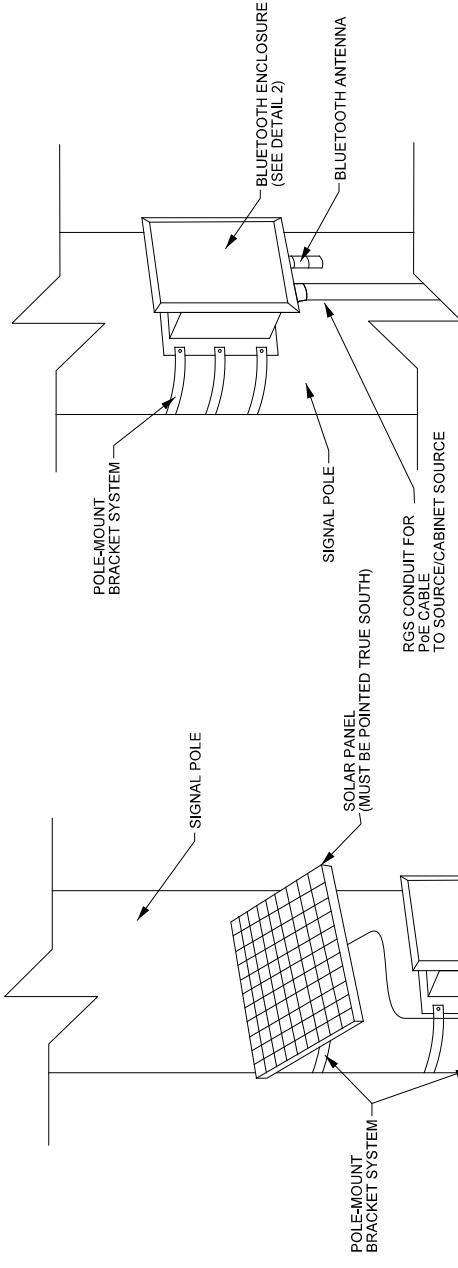

## POWER OVER ETHERNET (PoE)

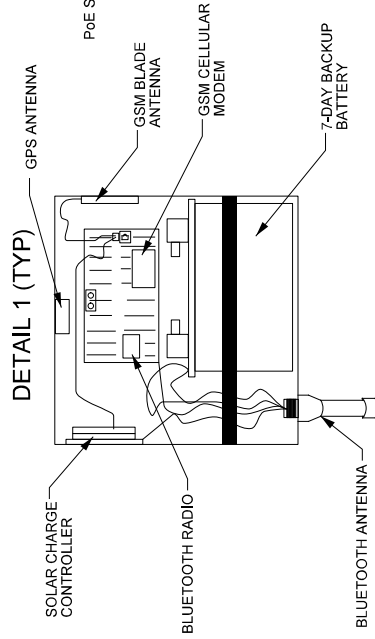

## DETAIL 2 (TYP)

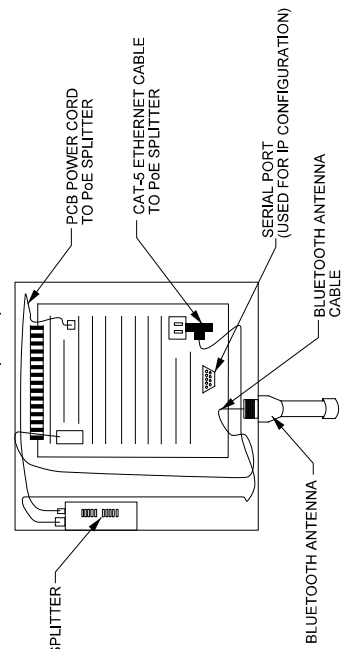

### GENERAL NOTES:

1. MEET THE REQUIREMENTS OF MIAMI-DADE TRAFFIC CONTROL EQUIPMENT STANDARDS AND SPECIFICATIONS SECTION 660 (VEHICLE DETECTION SYSTEM)
2. THE CONTRACTOR SHALL REFER TO THE FDOT'S APPROVED PRODUCT LIST (APL) AND THE MIAMI-DADE COUNTY QUALIFIED PRODUCT LIST SECTION 660 FOR AUTOMATIC VEHICLE IDENTIFICATION AND ALL MOUNTING HARDWARE APPROVED FOR USE IN MIAMI-DADE COUNTY AND SUBMIT SHOP DRAWINGS FOR APPROVAL BEFORE INSTALLATION. DRAWINGS MUST DEPICT THE APPROVED SOURCE/CABINET SOURCE FOR PoE.
3. IT IS THE CONTRACTOR'S RESPONSIBILITY TO REVIEW THE PLACEMENT OF THE AUTOMATIC VEHICLE IDENTIFICATION (BLUETOOTH) DEVICES AND COORDINATE WITH THE ENGINEER OF RECORD TO DETERMINE THE MOST OPTIMAL LOCATION FOR THE INSTALLATION OF THE REQUIREMENTS OF THE TECHNICAL SPECIFICATIONS OF AN APPROVED PRODUCT.
4. THE AUTOMATIC VEHICLE IDENTIFICATION (BLUETOOTH) DEVICE SHOULD BE PLACED 12' ABOVE GROUND LEVEL.

REVISION 03/21/17	DESCRIPTION TRAFFIC CONTROL EQUIPMENT STANDARDS AND SPECIFICATIONS	MIAMI-DADE	DTPW TRAFFIC SIGNALS AND SIGNS DIVISION 700 NW 36th STREET MIAMI, FLORIDA 33166 305.592.3580	NAME TRAVIS BREWER	DATE 09-29-16	SHEET NO. 1 of 1
				DRAWN BY TRAVIS BREWER	CHECKED BY NAIJUN FERNANDEZ	

TYPICAL AUTOMATIC VEHICLE IDENTIFICATION (BLUETOOTH) MOUNTING DETAILS (N.T.S.)

APPENDIX "M" TO SPECIAL PROVISIONS  
SECTION 671-TRAFFIC SIGNAL CONTROLLERS

## **SECTION 671 TRAFFIC SIGNAL CONTROLLERS**

### **PART 1 GENERAL**

#### **1.01 SUMMARY**

##### **A. Description**

1. Furnish and install a Caltrans Model 2070LX advanced transportation controller as required by the Contract Documents.

#### **1.02 REFERENCES**

- A. Traffic Control Equipment Specifications and Standards for Metro Traffic Control System, Miami-Dade County
- B. California Department of Transportation (Caltrans) Transportation Electrical Equipment Specifications (TEES), 2009 and Errata
- C. ATC 5201 v06.25: Advanced Transportation Controller (ATC) Standard Version 06
- D. National Transportation Communications for ITS Protocol (NTCIP) 1202: Object Definitions for Actuated Traffic Signal Controller (ASC) Units V02.19
- E. FDOT Standard Specifications for Road and Bridge Construction, Section 671 – Traffic Controllers
- F. Florida Department of Transportation Approved Products List (APL)
- G. Miami-Dade County Traffic Signals and Signs Division's Qualified Products List (TSSQPL)
- H. Caltrans' Traffic Signal Control Equipment Qualified Products List (QPL)
- I. National Electrical Manufacturers Association (NEMA) TS-2-2016

#### **1.03 SYSTEM DESCRIPTION**

##### **A. General Requirements**

1. Controllers must provide functionality that meets or exceeds operational characteristics, including NTCIP support, as described in NEMA TS-2-2016.
2. Controllers must capture all mandatory event-based data elements listed in the FDOT State Traffic Engineering and Operations Office supplemental requirements for controllers (*SR-671-2, Supplemental Traffic Controller High Resolution Data Logging Requirements*).
3. Controller software must meet or exceed the requirements of the Miami-Dade Traffic Signal Controller Local Software Specifications maintained by the Miami-Dade County Department of Transportation and Public Works (the Department).

#### **1.04 SUBMITTALS**

A. Certificates

1. The traffic controller submittal information must include certificates or other documented evidence that the 2070LX controller provided is approved and listed on the Caltrans QPL, FDOT APL, and TSSQPL.

B. Manufacturers' Instructions and Information

1. Submit or ensure that the following documentation from the manufacturer has been submitted to the Department:
  - a. Operation Manual
  - b. Troubleshooting and Service Manual
  - c. Assembly and installation instructions
  - d. Pictorial layout of components and schematics for circuit boards
  - e. Parts list
2. Electronic copies of all documentation must be provided. Electronic documentation must not require licenses, fees, or additional purchase for duplication or distribution.

**1.05 DELIVERY STORAGE AND HANDLING**

A. Packing, Shipping, Handling and Unloading

1. If the traffic controller is not packaged and shipped as part of a traffic controller assembly, ensure it is packaged in a manufacturer provided box and handled as per manufacturer's handling, storage, and protection requirements.

**1.06 WARRANTY**

- A. Ensure the traffic controller has a manufacturer's warranty covering defects for three years from the date of final acceptance. Ensure the warranty includes providing replacements within 10 calendar days of notification for defective parts and equipment during the warranty period at no cost to the Department.

**1.07 OWNER'S INSTRUCTIONS**

- A. Manufacturers' instructions and information documentation provided must describe all controller features and operations, including all user interfaces and settings required to configure the traffic controller.

**PART 2 PRODUCTS**

**2.01 MATERIALS AND EQUIPMENT**

- A. Controller must meet the latest Caltrans TEES, dated March 12, 2009, and TEES 2009 Errata requirements for a 2070LX Traffic Signal Controller unit and include, at minimum, the unit chassis, 2070-1C CPU, 2070-2E+ field I/O module, 2070-3B Front Panel, and 2070- 4A Power Supply.
- B. Controller must be approved and listed on the:
1. Caltrans' QPL as a Model 2070LX Controller Unit,

2. Florida Department of Transportation's APL, and
  3. Miami-Dade County Traffic Signals and Signs Division's TSSQPL.
- C. Ensure equipment is permanently marked with the manufacturer's name or trademark, part number, and serial number.

**2.02 EXTRA MATERIALS**

- A. A spare Data Key and a spare 2070-2E+ module must be provided for every ten traffic controllers supplied.
- B. A physical set of controller schematics and a repair manual must be provided for every one hundred traffic controllers supplied.

**2.03 ACCESSORIES**

- A. The controller must be provided with all accessories and incidental material necessary for installation and operation in a Miami-Dade traffic controller cabinet including, but not limited to, mounting hardware, power cable, data key, and interface card such that installation into the Miami-Dade cabinet does not require any additional components.

**2.04 SOURCE QUALITY CONTROL**

- A. Tests, Inspections
  1. Provide all documentation related to manufacturer Quality Assurance/Quality Control with regards to the controller, including batch/lot information as applicable, to the Department.

**PART 3 EXECUTION**

**3.01 PREPARATION**

- A. Equipment
  1. Verify the controller to be installed appears undamaged and in good working conditions prior to installation.
  2. Confirm that controller has been pre-programmed for site-specific operation and has passed all testing and verification requirements necessary for field deployment including establishing communication between the controller and central software.
  3. When replacing an existing controller, observe and document the current operational status of the intersection prior to controller replacement.
- B. Site Condition
  1. Preparation for controller replacement
    - a. Allow all stacked traffic to clear side streets.
    - b. Wait until main street is on green and traffic moving.
    - c. Ensure that pedestrians and other traffic in crosswalks have safely crossed the street. Place intersection in flash.

### 3.02 INSTALLATION

#### A. General

1. Install equipment as shown in the plans and according to the manufacturer's recommendations.

#### B. Removal

1. After verifying Flash control at intersection, turn off controller power, remove power cord, field I/O (C1) and communication (Ethernet/Serial) from the existing Traffic Controller.
2. Remove hardware retaining the Traffic Controller in rack.
3. Carefully remove existing Traffic Controller, ensure no wires are pinched or pulled from their current location.

#### C. Replacement

1. Carefully install the new Traffic Controller, ensure no wires are pinched or pulled from their connection.
2. Connect power, field I/O, and communication; Verify calls from detectors.
3. Using proper hardware, secure Traffic Controller into cabinet rack. Controller assembly includes all integration by the Contractor that is necessary for the proper operation of the controller assembly in the signal system.
4. Place intersection out of Flash and back in Traffic Control.

### 3.03 FIELD QUALITY CONTROL

#### A. Site Tests, Inspection

1. Ensure the intersection is functioning properly following controller installation, including verification that all vehicle and pedestrian detectors are properly mapped and placing calls to the traffic controller, and that all signals are operating properly.

END OF SECTION 671

APPENDIX "N" TO SPECIAL PROVISIONS  
"SECTION 682 TRAFFIC MANAGEMENT CCTV CAMERAS"

SECTION 682  
TRAFFIC MANAGEMENT CCTV CAMERAS

PART 1 GENERAL

**1.01 SUMMARY**

A. Description

1. Furnish and install a high definition (HD) internet protocol (IP) closed-circuit television (CCTV) camera and cabinet at the location(s) shown in the Plans. Use new equipment and components that meets the minimum requirements of these specifications. Ensure that the installed equipment provides the Video Display Equipment at the Miami-Dade County TSS Division Traffic Management Center (TMC) with unobstructed video of the roadway, traffic, and other current conditions around a roadside CCTV field site; that it responds to camera control signals from the TMC operator; and that the video images can be transmitted to remote locations for observation.

B. Method of Measurement

1. The Contract unit price for each CCTV camera system furnished and installed, will include furnishing, placement, and testing of all equipment and materials, and for all tools, labor, operational software packages and firmware, supplies, support, personnel training, shop drawings, documentation, and incidentals necessary to complete the work.

C. Basis of Payment

1. Prices and payment will be full compensation for all work and materials required by this Section.
2. Payment will be made under:

Item No.	Description	Unit
682-1-133	ITS CCTV Camera, F&I, Dome PTZ Enclosure - Non-Pressurized, IP, High Definition	EA

**1.02 REFERENCES**

- A. Miami-Dade County Traffic Signals and Signs Division's Qualified Product List (TSSQPL)
- B. FDOT Approved Product List (APL)
- C. National Electrical Manufacturers Association (NEMA) TS-2-2016
- D. Telecommunications Industry Association (TIA)-568



### 1.03 SYSTEM DESCRIPTION

#### A. Design Requirements

1. Design to meet the requirements of all applicable standards. Ensure that the CCTV camera, cabinet, mounting hardware, and any other camera-related material that is exposed to the environment can withstand loading from 150 mph wind speeds and meet the requirements of the FDOT Structures Manual, Volume 3.

#### B. Performance Requirements

1. CCTV camera must provide titling and masking features, including, but not limited to, programmable camera title, programmable preset titles for each preset position, and programmable privacy zones. Ensure that programmable titles are a minimum of 18 characters per line.
2. CCTV camera must provide the following features and capabilities:
  - a. Day (color)/night (monochrome) switchover and iris control, with user-selectable manual and automatic control capabilities.
  - b. Ability to produce clear, detailed, and usable video images of the areas, objects, and other subjects visible from a roadside CCTV field site. Ensure that video produced by the camera is true, accurate, distortion free, and free from transfer smear, oversaturation, and any other image defect that negatively impacts image quality under all lighting and weather conditions in both color and monochrome modes.
  - c. User-selectable automatic gain control (AGC) that is peak-average adjustable to 28 decibels (dB).
  - d. A minimum signal-to-noise ratio of 50 dB.
  - e. Automatic color balance that references the white areas of the scene through the lens.
  - f. An automatic electronic shutter that is user selectable from 1/60 to 1/10,000 of a second.
  - g. A digital signal processor that provides a minimum 10x digital zoom.
  - h. Programmable azimuth and compass display with ability to display pan and tilt position with a 1 degree resolution.
3. CCTV camera must comply with FDOT Specification Section 682-1.2.9 (Additional Requirements for IP Cameras) for:
  - a. Video Encoding
  - b. Encoded Video Interoperability
  - c. Encoded Video Specifications
  - d. Network Interface
  - e. Configuration Management

### 1.04 WARRANTY

- A. Ensure that CCTV cameras have a manufacturer's warranty covering defects for a minimum of three years. Ensure that the warranty requires the manufacturer to furnish replacements for any part or equipment found to be defective during the warranty period at no cost to the County within 10 calendar days of notification.

## PART 2 PRODUCTS

### 2.01 EQUIPMENT

- A. Use a dome-type High Definition (HD) Internet Protocol (IP) CCTV camera assembly that meet the requirements of this Specification and are listed on the Miami-Dade County TSS Division Qualified Products List (TSSQPL) and the Florida Department of Transportation (FDOT) Approved Product List (APL). Ensure equipment is permanently marked with the manufacturer's name or trademark, part number, and serial number and:
1. Is compatible with the current version of the FDOT's SunGuide® software system, and any other camera operating software indicated in the Plans and contract documents.
  2. Has a minimum 18x motorized optical zoom lens with automatic iris that is:
    - a. Capable of automatic and manual focus and iris control.
    - b. Have a lens depth of field provides a clear image of roadside areas under all lighting conditions; and
    - c. Has a maximum aperture of at least f/1.6.
  3. Has an integrated pan/tilt mechanism capable of providing 360 degree continuous pan with a minimum 90 degree tilt range (i.e., 0 degrees to minus 90 degrees); provide variable speed control; have a preset position return accuracy of plus or minus 0.36 degree, or less than 0.10% or better; support a minimum of 64 presets; support a minimum of one tour with a minimum of 32 presets; and support a minimum of eight programmable blackout zones.
  4. Has a positioner with a minimum automatic pan speed of 240 degrees per second to a preset camera position; that the maximum manual pan speed is a minimum of 80 degrees per second; and that maximum manual tilt speed is a minimum of 40 degrees per second.
  5. Supports the National Transportation Communications for ITS Protocol (NTCIP) 1205 v1.08. Ensure that the camera is capable of communication with other devices using Telecommunications Industry Association/Electronic Industries Alliance (TIA/EIA)-232 or TIA-422 at a rate of 9600 bps, transmission control protocol (TCP)/IP, or user datagram protocol (UDP)/IP. Ensure that the CCTV camera supports the communication links shown in the Plans. The camera must be capable of remote firmware upgrade via the communication interface.
  6. Supports the Open Network Video Interface Forum (ONVIF) Core, Streaming, and Media Service specification.
- B. Electrical Specifications:
1. Camera must operate on a nominal voltage of 120 volts alternating current (VAC). Supply an appropriate voltage converter for devices that require operating voltages of less than 120 VAC.
  2. Meet the requirements of FDOT Specification Section 620 for Grounding and Lightning Protection.
- C. Mechanical Specifications:
1. Provide camera housings and hardware that are light in color or as noted in the Plans.
  2. Ensure that the camera housing has a sunshield to reduce the solar heating of the camera. Ensure that the total weight of dome type CCTV cameras (including the

housing, sunshield, and all internal components) is less than 17.0 pounds. Ensure that the lower dome of the camera housing is distortion free clear plastic.

3. Ensure that pressurized dome-type housings are capable of pressurization at 5 pounds per square inch (psi) using dry nitrogen, that they have a low-pressure alarm feature, and has a NEMA 4X/IP-67 rating.
4. If a non-pressurized dome-type housing enclosure is used, ensure that the unit is vented with a thermostat-controlled heater and blower. Ensure that the non-pressurized enclosure has a NEMA 4/IP-66 rating.
5. Ensure that the total weight of external positioner-type CCTV cameras (including housing, sunshield, all internal components, and external pan and tilt mechanism) is less than 35 pounds.

D. Environmental Specifications:

1. Ensure that the CCTV camera performs all required functions during and after being subjected to the environmental testing procedures described in NEMA TS2, Sections 2.2.7, 2.2.8, and 2.2.9.

E. CCTV Equipment Cabinet.

1. General. The cabinet shell must be a Caltrans Type 336 cabinet type (36"H x 24"W x 20 to 22"D) meeting the requirements of FDOT Specification subarticle 676-2.5 (Intelligent Transportation System Cabinets) with a typical equipment layout as shown in FDOT Design Standards Index 18104. In urban areas where the minimum required right-of-way clearances cannot be maintained with a standard cabinet, a Miami-Dade County TSSQPL approved pole mounted CCTV cabinet may be proposed by the Engineer of Record as an alternative to the standard cabinet. When proposed, the alternative cabinet type must be shown on the Plans along with all detailed cabinet specifications meeting the Miami-Dade County Alternative CCTV Cabinet requirements.

## PART 3 EXECUTION

### 3.01 INSTALLATION

- A. Ensure that the CCTV camera is installed at the locations shown in the Plans. Install the CCTV camera in accordance with the Miami-Dade County standard details and as shown in the Plans.
- B. Furnish and install the power supplies, local control equipment, and any other camera-related field electronic equipment and transient voltage surge suppressors within the approved lockable CCTV cabinet. Ensure that the cabinet protects these electrical and electronic devices from rain, dust, dirt, and other harmful elements of nature.
- C. Furnish and install all power, video, and data cables necessary to provide connection points for camera video and pan/tilt/zoom (PTZ) control signals within the cabinet. Furnish and install any and all ancillary equipment required to provide a complete and fully operational CCTV camera. Verify that all wiring meets National Electric Code (NEC) requirements where applicable.
- D. Ensure that data and video cables from the pole to the camera are routed inside the mounting hardware and protected from exposure to the outside environment.

- E. Coat the exterior of the dome-type enclosure's lower half with a manufacturer-approved clear, rain repellant product prior to final acceptance.

**3.02 FIELD QUALITY CONTROL**

- A. Subject the equipment covered by these specifications to a field acceptance test (FAT). Develop and submit a test plan to Engineer for review and approval. Ensure that the test plan demonstrates each and every functional requirement specified for the device or system under test. Engineer reserves the right to witness all tests:
- B. Field Test Requirements: Perform local field operational tests at CCTV field sites according to the following:
  - 1. Verify that physical construction has been completed as specified in the Plans.
  - 2. Verify the quality and tightness of ground and surge protector connections.
  - 3. Verify proper voltages for all power supplies and related power circuits.
  - 4. Verify all connections, including correct installation of communication and power cables.
  - 5. Verify that the video signal from the camera is present and of consistent quality at all connection points between the camera, the cabinet, and any video devices therein.
  - 6. Verify camera network configuration settings are correct and that encoded video from the camera can be viewed on the network via a local connection at the field site and from the TMC. Verify that field site and TMC video quality is consistent and does not exhibit source degradation such as distortion and artifacts.
  - 7. Exercise PTZ and focus in all directions and execute a minimum of three other unique programming commands to ensure that the communication link between the cabinet and the camera is functioning properly.

END OF SECTION 682

# TYPICAL MAST ARM CCTV MOUNTING DETAILS

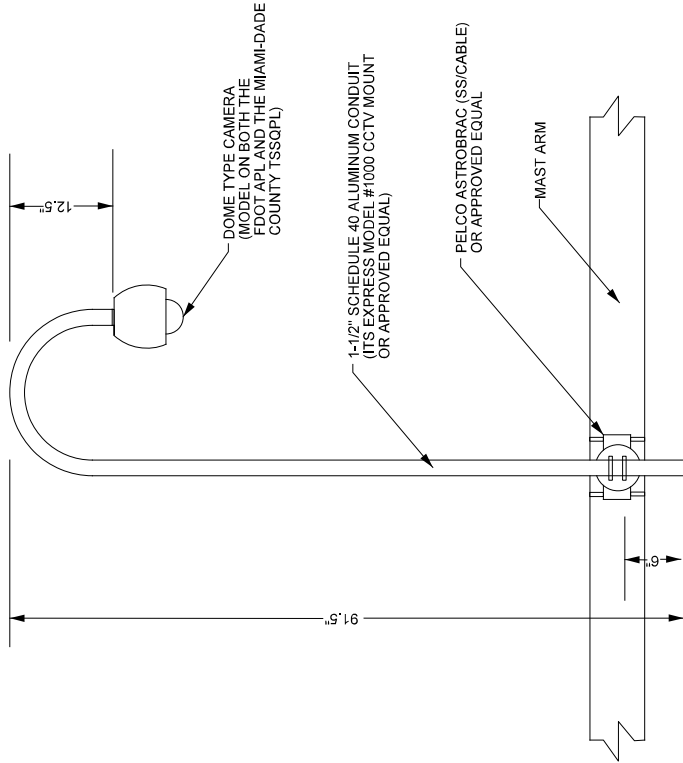

**MAST ARM MOUNT**

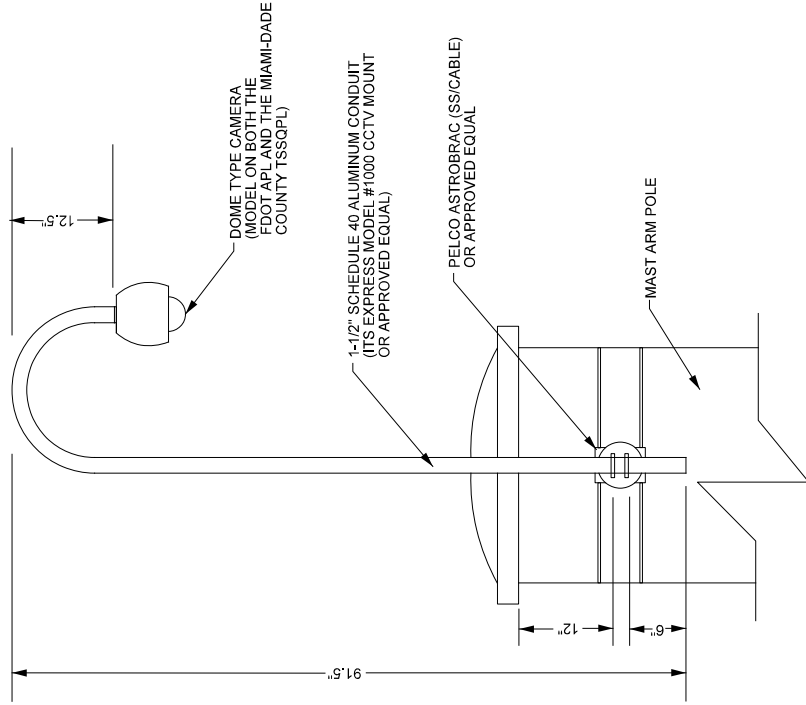

**MAST ARM POLE MOUNT**

**GENERAL NOTES:**

1. MEET THE REQUIREMENTS OF MIAMI-DADE COUNTY TRAFFIC CONTROL EQUIPMENT STANDARDS AND SPECIFICATIONS SECTION 682 (TRAFFIC MANAGEMENT CCTV CAMERAS).
2. SITE PLANS MUST IDENTIFY SPECIFIC PLACEMENT LOCATION ON MAST ARM. PROVIDE CERTIFICATION AND CALCULATIONS FROM ENGINEER OF RECORD THAT PROPOSED PLACEMENT WILL MEET APPLICABLE WIND LOADING REQUIREMENTS AND NOT EXCEED DESIGN LOADING LIMITS OR THE MAST ARM ASSEMBLY.
3. INCLUDE SITE-SPECIFIC DETAILS WITH PLANS THAT INCLUDE WIRING, CABLE ROUTING AND SUPPORTING SYSTEM EQUIPMENT.

REVISION 03/24/17	DESCRIPTION TRAFFIC CONTROL EQUIPMENT STANDARDS AND SPECIFICATIONS	 DTPW TRAFFIC SIGNALS AND SIGNS DIVISION TRAFFIC ENGINEER MIAMI, FLORIDA 33186 305.592.2580	DRAWN BY TRAVIS BREWER	DATE 03-23-16	SHEET 1 of 1
			CHECKED BY MICHAEL FERNANDEZ	DATE 03-22-17	
TYPICAL MAST ARM CCTV MOUNTING DETAILS (N.T.S.)					

# ALTERNATIVE CCTV CABINET AND EQUIPMENT LAYOUT DETAILS

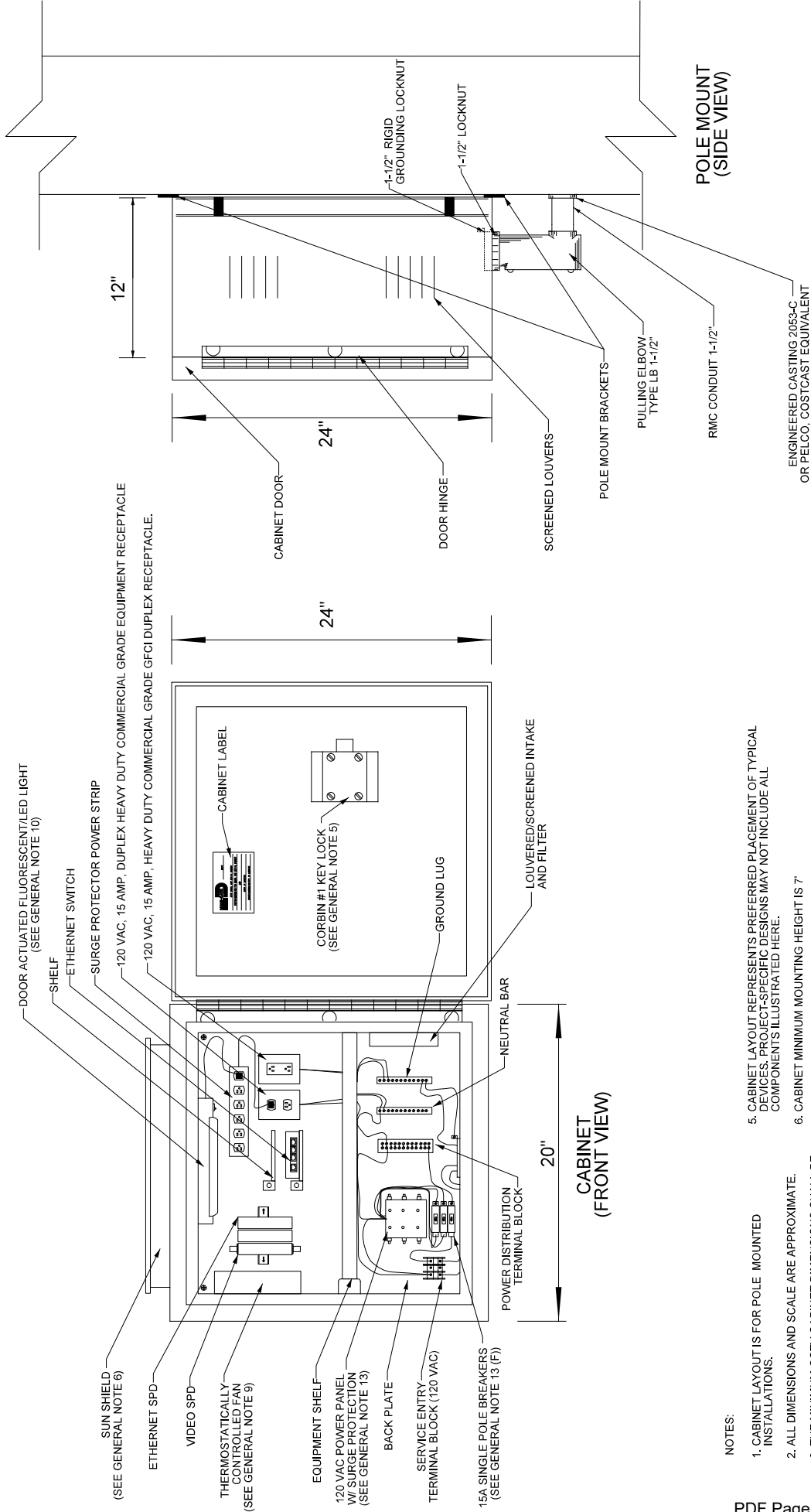

- NOTES:**
- CABINET LAYOUT IS FOR POLE MOUNTED INSTALLATIONS.
  - ALL DIMENSIONS AND SCALE ARE APPROXIMATE.
  - THE MINIMUM CCTV CABINET DIMENSIONS SHALL BE 24"H X 20"W X 12"D.
  - CABINET MUST HAVE A 1-1/2" KNOCKOUT HOLE AT THE BOTTOM FOR POWER CONDUIT.
  - CABINET LAYOUT REPRESENTS PREFERRED PLACEMENT OF TYPICAL DEVICES. PROJECT-SPECIFIC DESIGNS MAY NOT INCLUDE ALL COMPONENTS ILLUSTRATED HERE.
  - CABINET MINIMUM MOUNTING HEIGHT IS 7'
  - WIRING IS SHOWN FOR ILLUSTRATION ONLY. REFER TO MANUFACTURER'S WIRING DIAGRAM FOR DETAILS.

REVISION 04/19/17	DESCRIPTION: TRAFFIC CONTROL EQUIPMENT STANDARDS AND SPECIFICATIONS	DTPW TRAFFIC SIGNALS AND SIGNS DIVISION 100 W 36TH STREET MIAMI, FLORIDA 33166 305.592.3580	NAME TRAVIS BREWER	DATE 10-26-16	SHEET 1 of 2
			DESIGN DIRECTOR INHUM FERNANDEZ	DATE 03-22-17	
			APPROVED BY: FRANK WEA, P.E.		
ALTERNATIVE CCTV CABINET AND EQUIPMENT LAYOUT DETAILS (N.I.S.)					

GENERAL NOTES:

ALTERNATIVE CCTV CABINET MUST BE:

1. MEET THE REQUIREMENTS OF MIAMI-DADE COUNTY TRAFFIC CONTROL EQUIPMENT STANDARDS AND SPECIFICATIONS SECTION 682 (TRAFFIC MANAGEMENT CCTV CAMERAS).
2. UL LISTED, FOOT APL CERTIFIED, AND ON MIAMI-DADE COUNTY TSSOPL.
3. FOOT APL CERTIFIED COMPONENTS AND ENCLOSURE MEETING THE REQUIREMENTS OF FDOT SPECIFICATION SUBARTICLE 676-2.5 EXCEPT THE MINIMUM SIZE MAY BE 24" H X 20" W X 12" D WITH A SINGLE DOOR THAT IS HINGED ON RIGHT SIDE WHEN VIEW FROM FRONT.
4. STAINLESS STEEL CABINET HARDWARE, TYPE 304 AND TWO 19" EIA RACK ANGLES AND MINIMUM 10" DEEP RACK MOUNTED SHELF.
5. DOOR: CORBIN STYLE, #1, DEADBOLT LOCK, WITH TWO KEYS; CONTINUOUS, 14 GAUGE STAINLESS STEEL HINGE WHICH CANNOT BE REMOVED WITHOUT OPENING DOOR.
6. SUN SHIELD THAT SHIELDS THE ENTIRE HOUSING, EXCEPT THE DOOR, FROM DIRECT SUNLIGHT, CONSTRUCTED SO THAT IT ALLOWS THE FREE PASSAGE OF AIR BETWEEN THE CABINET AND THE SHIELD, BUT DOES NOT FORM A "SAIL" PLACING AN EXCESSIVE LOAD ON THE CABINET MOUNTING STRUCTURE IN HIGH WINDS, TOP SLOPED TO REAR TO PREVENT STANDING WATER.
7. ONE SPARE DIN-RAIL.
8. INSULATION PARTS AND WIRE INSULATION CAPABLE OF WITHSTANDING A MINIMUM OF 600 VOLTS.
9. FILTERED VENT OPENINGS WITH 4" 100 CFM BALL BEARING, 120 VAC FAN WITH FAN THERMOSTAT, 1A FUSE AND FUSE HOLDER, AND RIC NOISE SUPPRESSOR.
10. DOOR ACTUATED FLUORESCENT (OR EQUIVALENT LED) LIGHTING FIXTURE INCLUDES A COOL WHITE LAMP, COVERED AND OPERATED BY A NORMAL POWER FACTOR, UL LISTED BALLAST.

11. DOOR SWITCH FOR ALARM LOCATED IN THE BOTTOM POSITION OF THE DOOR SWITCH BRACKET.
12. EQUIP THE CABINET WITH CIRCUIT BREAKERS; RADIO INTERFERENCE FILTERS; GROUND LOOP ISOLATORS; LIGHTING ARRESTERS AND SURGE PROTECTOR MEETING THE REQUIREMENTS OF FDOT SPECIFICATION SECTION 620.
13. POWER PANEL, FRONT RACK MOUNTED, EQUIPPED WITH AND WIRED FOR:
  - A) 15A, 120VAC, 3W, SINGLE PHASE POWER.
  - B) SERVICE ENTRANCE TERMINAL BLOCKS; FINGER-SAFE, SCREW TYPE.
  - C) POWER DISTRIBUTION TERMINAL BLOCKS; FINGER-SAFE, SCREW TYPE.
  - D) GROUNDING LUG.
  - E) (1) MAIN POWER SURGE ARRESTOR, 120 / 240 VAC, 50 KA.
  - F) (1) 15 AMP, SINGLE POLE, MAIN CIRCUIT BREAKER.
  - G) (2) 15 AMP, SINGLE POLE, CIRCUIT BREAKERS; PROTECT THE FLUORESCENT LIGHT, GFCI-PROTECTED DUPLEX RECEPTACLE, AND FAN WITH ONE BREAKER. PROTECT THE CCTV EQUIPMENT WITH OTHER BREAKER.
  - H) RECEPTACLES:
    - 1) 120 VAC, 15 AMP, DUPLEX HEAVY DUTY COMMERCIAL GRADE EQUIPMENT RECEPTACLE.
    - 2) 120 VAC, 15 AMP, HEAVY DUTY COMMERCIAL GRADE GFCI DUPLEX RECEPTACLE.
14. CABINET AND MOUNTING HARDWARE MUST MEET THE LOAD REQUIREMENTS OF SECTION 3 AASHTO L1S-6 AS MODIFIED BY FDOT STRUCTURES MANUAL VOLUME 3 USING A BASIC WIND SPEED (V) OF 150 MPH.

APPENDIX "O" TO SPECIAL PROVISIONS  
"INTERNALLY ILLUMINATED STREET NAME SIGNS (IISNS)  
MIAMI-DADE COUNTY"



**INTERNALLY ILLUMINATED STREET NAME SIGNS (IISNS)  
MIAMI-DADE COUNTY**

**GENERAL:**

1. IISNS shall be manufactured by Southern Manufacturing Co.; Quantum Lite; Transportation Control System, or a Miami-Dade County PWD-TS&S Pre-Approved equivalent.
2. Street Name sign housing shall be either constructed of a one-piece aluminum box or shall have the frame/housing fabricated out of extruded aluminum alloy inserted into aluminum corner brackets with one (1) side provided with a white polycarbonate blank for a street name legend and the backside and/or top/bottom shall be fabricated for rigid mounting of the unit with adjustable rigid mast arm mounting brackets (Pelco Astro-Brac or approved equivalent) for a rigid (face mount) to the traffic signalization mast arm.
3. The sign shall be fabricated with a “standard” length and height of 72-inches x 24-inches. The housing shall a Powder Coat finish, which shall be Flat Black in color.
4. Sign face shall have a Retroreflective Transparent Green Sheeting and shall be applied to the polycarbonate sign blank with completed sign legend. Green Transparent Sheeting shall be equivalent retroreflectivity to the County’s static Overhead Street Name signs currently installed.
5. IISNS must comply with minimum FDOT standards and shall be on the State’s current (Approved Product List) APL. In addition, the IISNS shall comply with all M-DPWD requirements.
6. Signs shall be shipped to the County with street name legends complete and installed in each sign housing per a list provided by the County/State provided to the Vendor and/or Contractor at time of purchase order.
7. Signs shall be fabricated to conform to FDOT Section 699.
8. Housings shall not have any unused holes or openings provided in the housing for any other mounting design(s); hardware (photocell); or wiring, not used or approved for use in Miami-Dade County rigid mast arm street name sign installations.
9. Manufacturer Detail Drawings and specifications submitted to the County for approval shall be complete with weights and wattages for both Fluorescent and LED type IISNS. All manufacturer drawings shall be drawn to scale.

**GENERAL** (Continued)

10. Submittal Data must be approved, by the County, prior to delivery to the County on Purchase Orders (P.O.); or installation by a Contractor; on all County, State, or Private Developer projects in Miami-Dade County, Florida. Failure to do so shall be cause for possible REJECTION by the County. Any additional costs for the IISNS associated with failure to comply with this standard, by the Contractor; other governmental agency; Manufacturer; Supplier/Vendor, shall in no way be cause for additional compensation be paid by the County.
11. All hardware used in the construction of the sign shall be stainless steel type 304 or 305 only.
12. Housing Mounting Designs:

- a) Top/Bottom Standard Mounting (TBSM) bracket design (Southern Manufacturing Co. and Transportation Control System) shall only have holes located where the tri-stud mount is installed. No other holes shall be located outside of the mounting bracket. 4-conductor cable shall be routed thru the mounting bracket into the bottom of the housing per the attached Detail Drawings.

Mounting brackets must conform to MD-PWD standards/specification and manufacturer's recommendations. The adjustable rigid mast arm mounting bracket assemblies shall have holes provided to easily rout cable thru the center of the mast arm adjustable mounting bracket attachment and sign bracket attachment for easy access into the aluminum tubes. The aluminum tubes used in the (TBSM) adjustable bracket shall be provided with a slot, [minimum length of nine-inches (9")] centered for easy access and routing of the 4-conductor cable through the hollow bottom sign bracket assembly into the IISNS.

- b) Top/Bottom Narrow mount (TBNM) Rail clamp bracket design (Quantum Lite) shall have no holes in the top and bottom of the housing. The attachment of the IISNS to the bracket shall be provided by top/bottom rail clamps to the extruded aluminum housing frame. 4-conductor cable shall be routed thru the mounting bracket into the rear of the housing per the attached Detail Drawings.

Mounting brackets must conform to MD-PWD standards/specification and manufacturer's recommendations. Aluminum tubes used in the (TBNM) adjustable bracket shall not require any slot, however, the adjustable rigid mast arm mounting bracket assemblies shall have holes provided to easily rout cable thru the center of the mast arm adjustable mounting bracket attachment and sign bracket attachment for easy access for routing of the 4-

## **GENERAL** (Continued)

conductor cable between the bracket and the IISNS externally rear-mounted electrical junction box.

**13.** Rubber grommets shall be used throughout the sign where wires and/or cables are routed thru the housing and/or panel per National Electrical Code (NEC).

**14.** Sign Legends and Layout Requirements:

- a) Sign legends shall use Highway Gothic only; the series shall be “D” a.k. rev. c; “C” a.k. rev. c; or “B” a.k. rev. c. as noted below.
- b) The sign fabricator shall layout the signs using the larger series (wider/thicker) letter(s) and numerals. In the event the legend layout [do to PWD required legend size and/or long legend(s)] cannot fit the sign parameters, then the fabricator shall either modify the legend spacing and/or reduce series from series “D” to “C” or “B” in extreme cases.
- c) Legends shown in guide (in some cases) may show “worst case” example (i.e. upper/lower case letters with one or more of the following letters: g, j, p, q, or y) in that event a smaller legend size was shown to be used. The fabricator following the guidelines should try to make all legend sizes as large as possible.
- d) Legend layout drawings for each sign face shall be submitted and approved by the PWD prior to fabrication. Failure to do so by the manufacturer, if unacceptable, shall be re-done at no additional cost to the County.
- e) The Typical Legend Layout Guide is provided as a guide to the sign fabricator. It should be noted that each line (one or two), the legend layout for each (letters and numerals) shall be “centered” vertically. NOTE: When used, the Cardinal Directions **NORTH**; **SOUTH**; **EAST**; and **WEST** shall have all letters, as shown, with all letters on the same line as the larger first letter.

## **ADJUSTABLE RIGID MAST ARM MOUNTING BRACKETS:**

1. All brackets shall have the wire entrance arm (hollow arm) supplied with stainless steel tri-studs on the Signal Head or IISNS attachment side; the aluminum tube side (fixed side) shall be provided with an internally cast-in-place 1-1/2-inch NPT into the aluminum casting and with two (2) stainless steel set-screws through the casting to rigidly secure the tube to the hollow arm. The aluminum casting shall have no bushings/nipples of any type cast into the aluminum other than stainless steel components. The aluminum tube shall be supplied threaded at one end only.
2. The bracket arm (solid arm slide-on) used on the other opposite end of the aluminum tube shall be supplied with stainless steel tri-studs on the signal head or IISNS attachment side; the aluminum tube side with the slide-on arm shall be equipped with two (2) stainless steel set screws to secure in place the arm to the aluminum tube.
3. All aluminum tubes used with the attachment method described in 1 and 2 above shall be supplied with a PWD approved wire entrance slot minimum 1/2-inch to maximum 3/4-inch wide centered in the tube length; additionally the aluminum extrusions shall have structural gussets (ribs) for continuous support running the entire length of the tube to prevent deformation of the tube. The interior of aluminum tube shall be required to have ample space for the signal cable to run through the tube between the bracket assembly and the signal head or internally illuminated sign.
4. When more than one Adjustable Rigid Mast Arm Bracket is used for mounting an Internally Illuminated Sign (i.e. IISNS, etc.) the sign assembly can be provided with only one Adjustable Rigid Mast Arm Bracket supplied with the tube assembly with a slot for the signal cable to the "wiring side" of the sign installation. The "second" bracket assembly for the sign can be provided with a threaded non-slotted tube. Non-slotted tubes shall not be required to have structural ribs extruded into the tubing.
5. Brackets shall be of a design and construction similar to Miami-Dade County's vehicular traffic signal head horizontal adjustable rigid mast arm mounting brackets (Pelco Astro-Brac or approved equivalent) and shall be constructed of aluminum with stainless steel aircraft cable and hardware only.
  - a) Top/bottom Standard Mount (TBSM) Tri-stud brackets (Southern Manufacturing Co. design), used with "Standard" IISNS top/bottom mount design signs. Refer to attached referenced Detail Drawings.
  - b) Top/Bottom Narrow mount (TBNM) Rail clamp brackets (Quantum Lite design), used with "Slim-line" top/bottom housing "rail" mount design signs. Refer to attached referenced Detail Drawings.

### **ADJUSTABLE RIGID MAST ARM MOUNTING BRACKETS** (Continued)

6. Attachment of brackets to the mast arm shall be made with stainless steel aircraft grade cable. No other attachment cable/material shall be accepted.
7. Mounting bracket aluminum components/assemblies and shall have natural aluminum finish.
8. Brackets shall be designed to provide easy access and routing for internal wiring of the IISNS between the mast arm and the sign(s). No external method of wiring shall be permitted other than specified herein. Refer to M-DPWD Detail Drawing requirements for different IISNS sign types.

### **PHOTOELECTRIC CELL AND MOUNTING:**

1. The Photoelectric Cell shall be Intermatic Inc. Model # K4221 (120V) or PWD-TS&S approved equivalent. Only the "Lead" IISNS shall have the photocell attached to the housing, which shall be rated to control a minimum of four (4) IISNS per intersection.
2. Only one (1) photocell shall be used per intersection to control the IISNS.

## **SUBMITTAL DATA DOCUMENTATION:**

1. Sign (IISNS) shall include the following:
  - a) Sign Manufacturer Model Number(s) and copy of FDOT APL certificate(s).  
Manufacturer Submittal Drawings and specifications, as specified above, for:
    - 1-Fluorescent Model, when specified (each).
    - 2-LED Model, when specified (each).
  - b) Adjustable Rigid Mast Arm Mounting Brackets – Manufacturer(s) Name and Part Number(s) and copy of FDOT APL certificate(s).
  - c) Photoelectric Cell shall have Manufacturer Name and Part Number complete with specifications and drawings.
2. IISNS mounting bracket and attachment method shall be as per Manufacturer recommendations and M-DPWD standards. The Contractor shall submit, to Miami-Dade County Public Works Department, Traffic Signs & Signal Division, Manufacturer mounting bracket data sheet(s), detail drawings and installation procedure, for approval, prior to any material procurement. Failure to do so by the Contractor, in the event of rejection by the County, shall in no way be cause for additional compensation.

## **WARRANTY:**

1. **Fluorescent IISNS:** The Manufacturer shall guarantee the internally illuminated fluorescent sign for a period of three (3) years from date of receipt by Miami-Dade County, and shall replace, free of charge, any part or parts claimed within the period to be defective in workmanship or materials.
2. **LED IISNS:** The Manufacturer shall guarantee the internally illuminated LED sign for a period of three (3) years from date of receipt by Miami-Dade County, and shall replace, free of charge, any part or parts claimed within the period to be defective in workmanship or materials, however, the LED components (i.e. LED's and electronic circuitry assembly) shall be warranted for a total period of five (5) years from date of receipt by the County, and shall have replaced free of charge by the Manufacturer, any defect in workmanship or materials on these components.

## IISNS TYPICAL LEGEND LAYOUT GUIDE (72" x 24")

### 1) Single Line with Number Legend:

A) **SW 87 AV**

B) **W 41 ST**

C) **5 Street**

UPPER Case  
LETTERS 10"  
Number(s) 12"

UPPER Case  
LETTERS 10"  
Number(s) 12"

UPPER/lower Case+  
LETTERS 10"  
Number(s) 12"

+ Special: When no compass directions are used (i.e. Miami Beach)

### 2) Single Line with Name Legend:

A) **W Flagler St**

B) **Old Cutler Rd**

C) **Byron Av**

UPPER/lower Case\* Letters 12"

\* Reduce spacing/letter height to fit sign (Minimum 10")

### 3) Dual Line with Number & Name Legend:

A) **SW 88 ST**  
**N Kendall Dr**

B) **NW 186 ST**  
**Miami Gardens Dr**

UPPER Case LETTERS 8"; Number(s) 10"

UPPER/lower case\* Letters 6"

\* Reduce spacing/letter height to fit sign (Minimum 5")

**4) Single Line with Number / Number (Municipality & County Designation):**

A) Hialeah **E 25 ST / NW 79 ST**

\*\* (Left side – 1 or 2 Digits) UPPER Case LETTERS 8”; Number(s) 10” /  
\*\* (Right side – 2 Digits) UPPER Case LETTERS 8”; Number(s) 10”

B) Hialeah **W 68 ST / NW 122 ST**

\*\* (Left side - 2 Digits) UPPER Case LETTERS 8”; Number(s) 10” /  
\*\* (Right side 3 - Digits) UPPER Case LETTERS 6”; Number(s) 8”

**5) Dual Line with Number/Number & Name  
(Municipality & County Designation):**

Hialeah

A)\*\* **W 32 AV / NW 92 AV**  
**Ed Wallace Blvd**

\*\* (Left side – 1 or 2 Digits) UPPER Case LETTERS 8”; Number(s) 10” /  
\*\* (Right side – 2 Digits) UPPER Case LETTERS 8”; Number(s) 10”  
UPPER/lower case\* Letters 6”  
\* Reduce spacing/letter height to fit sign (Minimum 4”)

B)\*\* **W 49 ST / NW 104 ST**  
**Palm Springs Mile**

\*\* (Left side - 2 Digits) UPPER Case LETTERS 8”; Number(s) 10” /  
\*\* (Right side 3 - Digits) UPPER Case LETTERS 6”; Number(s) 8”  
UPPER/lower case\* Letters 6”  
\* Reduce spacing/letter height to fit sign (Minimum 4”)



Homestead

A)\*\*

**SE 8 ST/SW 328 ST  
Campbell Dr**

\*\* (Left side - 1 Digit) UPPER Case LETTERS 8"; Number(s) 10" /

\*\* (Right side 3 - Digits) UPPER Case LETTERS 8"; Number(s) 10"  
UPPER/lower case\* Letters 6"

\* Reduce spacing/letter height to fit sign (Minimum 4")

B)\*\*

**SE 12 AV/SW 167 AV  
Tennessee Rd**

\*\* (Left side - 2 Digits) UPPER Case LETTERS 8"; Number(s) 10" /

\*\* (Right side 3 - Digits) UPPER Case LETTERS 6"; Number(s) 8"  
UPPER/lower case\* Letters 6"

\* Reduce spacing/letter height to fit sign (Minimum 4")

**6) Dual Line with Number/Name w/ 2<sup>nd</sup> Name Legend:**

**SW 87 AV / Galloway Rd  
St Marcellin Champagnat Way**

**SW 24 ST / Coral Way  
Brothers to the Rescue Martyrs Blvd**

UPPER Case LETTERS 8";  
Number(s) 10"/ UPPER/lower  
case\* Letters 6"

\* Reduce spacing/letter height to fit sign

UPPER/lower case\*\* 5"

\*\* Reduce spacing/letter height  
(Minimum 4")

UPPER Case LETTERS 8";  
Number(s) 10"/ UPPER/lower  
case\* Letters 6

\* Reduce spacing/letter height to fit sign

UPPER/lower case\*\* 4"

\*\* Reduce spacing/letter height to fit sign  
(Minimum 4")

**7) Dual Line with US 1 & Name:**

**US 1**  
**Biscayne Blvd**

**US 1**  
**S Dixie Hwy**

UPPER Case 'US' LETTERS 10"; Number(s) 10"  
UPPER/lower case Letters 6"

**8) Dual Line with US 1 & Name/Name:**

**US 1 / S Dixie Hwy**  
Trpr Buck Buchanan Mem Hwy

**US 1 / S Dixie Hwy**  
Pinecrest Pkwy

UPPER Case 'US' LETTERS 10"; Number(s) 10" / UPPER/lower case\* Letters 10"  
\* Reduce spacing/letter height to fit sign (Minimum 8")  
UPPER/lower case\*\* Letters 6"; 5" or 4"  
\*\* Reduce spacing/letter height to fit sign (Minimum 4")  
Abbreviations approved on a sign-by-sign basis

**9) Single Line with Expressway Ramps:**

A)

B)

C)

D)

**SR 826 NORTH**

**SR 874 SOUTH**

**SR 836 EAST**

**SR 878 WEST**

UPPER Case LETTERS 'SR' 8" and all letters following the first letter;  
Number(s) 10" and 'First' cardinal direction letter (N, S, E & W)

**10) Single Line with Turnpike Ramps:**

- |    |                       |    |                       |
|----|-----------------------|----|-----------------------|
| A) | <b>Turnpike NORTH</b> | B) | <b>Turnpike SOUTH</b> |
| C) | <b>Turnpike EAST</b>  | D) | <b>Turnpike WEST</b>  |

UPPER/lower Case Letters 'Turnpike' 10" and 'first' cardinal direction letter (N, S, E & W); all letters following the first cardinal direction letter 8"

**11) Single Line with Interstate Ramps:**

- |                   |                   |
|-------------------|-------------------|
| <b>I-95 NORTH</b> | <b>I-75 SOUTH</b> |
| <b>I-395 EAST</b> | <b>I-195 WEST</b> |

UPPER Case Letter 'I' and Number(s) 10" and 'first' cardinal direction letter (N, S, E & W); all letters following the first cardinal direction letter 8"

**12) Dual Line with Number/Name w/ 2<sup>nd</sup> Name & 3<sup>rd</sup> Name Legend:**

- |   |   |
|---|---|
| <b>SW 8 ST/ Tamiami Trail</b><br><b>Calle Ocho / Olga Guillot Way</b> | <b>SW 8 ST/ Tamiami Trail</b><br><b>Calle Ocho / Celia Cruz Way</b> |
|---|---|

UPPER Case LETTERS 8"; Number(s) 10"/ UPPER/lower case\* Letters 6"

\* Reduce spacing/letter height to fit sign

UPPER/lower case\*\* 6"; 5" or 4"

\*\* Reduce spacing/letter height to fit sign (Minimum 4")

**13) Single Line UPPER CASE Only Special Cases:  
( Transit, Places and Fire Station Driveway)**

A) **BUSWAY**

UPPER Case LETTERS 12"

B) **MAST ACADEMY**

UPPER Case LETTERS\* 12"  
\* Reduce spacing/letter height to fit sign

C) **TENNIS CENTER**

UPPER Case LETTERS\* 10"  
\* Reduce spacing/letter height to fit sign

D) \*\* **EMERGENCY SIGNAL**

UPPER Case LETTERS 10"  
\*\* BLACK LEGEND on WHITE BACKGROUND

REVISED 11-01-07  
INTERNALLY ILLUMINATED STREET NAME SIGNS (IISNS)  
MIAMI-DADE COUNTY

INTERNALLY ILLUMINATED STREET NAME SIGNS (IISNS)  
MIAMI-DADE COUNTY-Revised 08-01-08

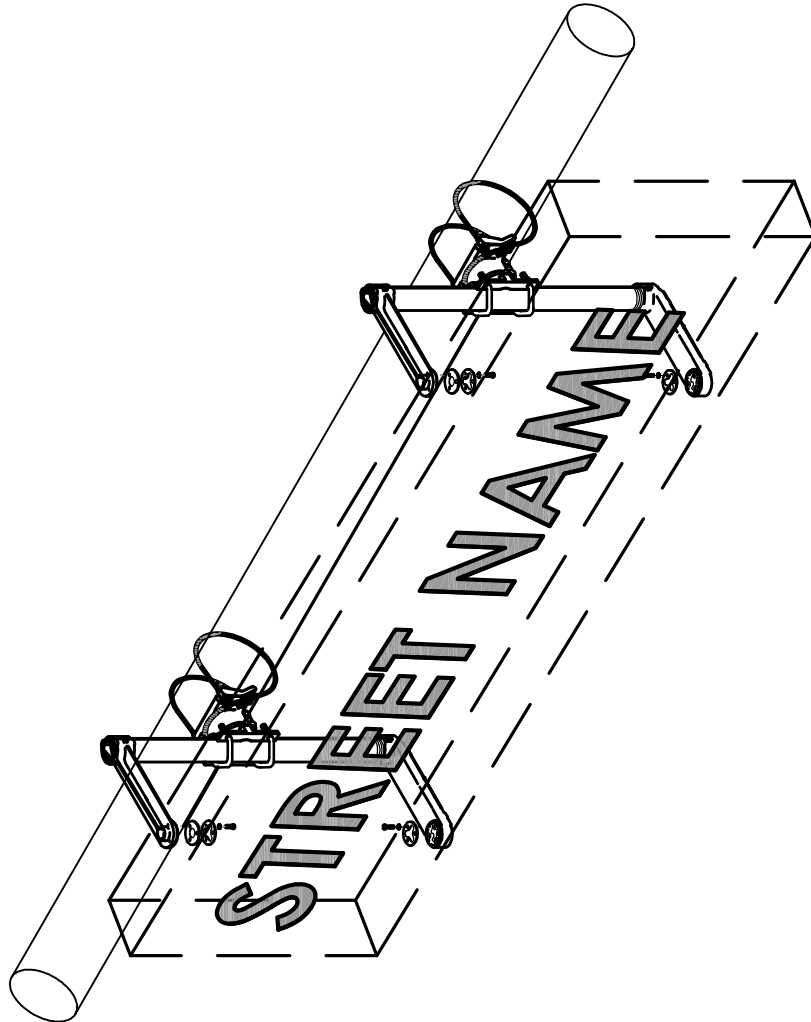

Note: All installation procedures shall follow Traffic Control Equipment Specifications and Standards (TCES) and National Electrical Code (NEC).

TOP/BOTTOM STANDARD MOUNTING (TBSM)  
IISNS DETAIL N.T.S.

3081

3081

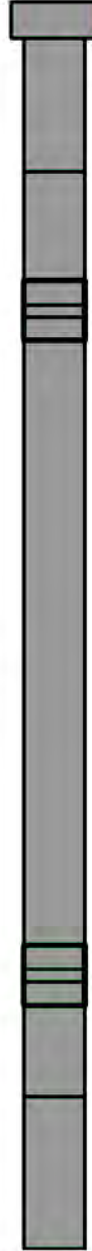
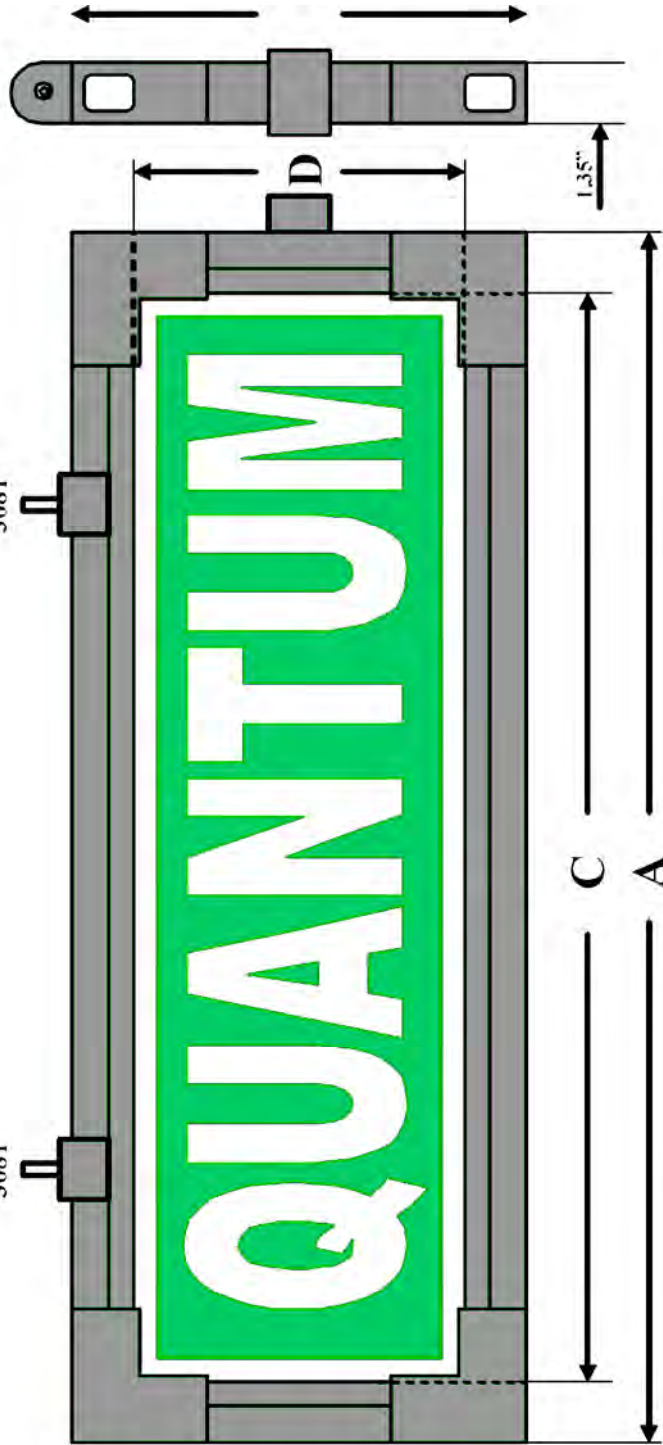

STANDARD STREET NAME SIGN

O.S.N. - 2.4 S / O.S.N. - 2.4 D	A		B		C		D	
	Total Length	Total Width	Total Width	Viewable	Viewable	Viewable Width	Viewable Width	
O.S.N. - 3.6 S / O.S.N. - 3.6 D	2.7 - 2.5 "	1.9 - 2.5 "	1.9 - 2.5 "	2.3 "	1.5 "	1.5 "	1.5 "	
O.S.N. - 4.8 S / O.S.N. - 4.8 D	3.9 - 2.5 "	1.9 - 2.5 "	1.9 - 2.5 "	3.5 "	1.5 "	1.5 "	1.5 "	
O.S.N. - 6.0 S / O.S.N. - 6.0 D	5.1 - 2.5 "	1.9 - 2.5 "	1.9 - 2.5 "	4.7 "	1.5 "	1.5 "	1.5 "	
O.S.N. - 7.2 S / O.S.N. - 7.2 D	6.3 - 2.5 "	1.9 - 2.5 "	1.9 - 2.5 "	5.9 "	1.5 "	1.5 "	1.5 "	
O.S.N. - 8.4 S / O.S.N. - 8.4 D	7.5 - 2.5 "	1.9 - 2.5 "	1.9 - 2.5 "	7.1 "	1.5 "	1.5 "	1.5 "	
O.S.N. - 9.6 S / O.S.N. - 9.6 D	8.7 - 2.5 "	1.9 - 2.5 "	1.9 - 2.5 "	8.3 "	1.5 "	1.5 "	1.5 "	

Note: All installation procedures shall follow Traffic Control Equipment Specifications and Standards (TCESS) and National Electrical Code (NEC).

TOP/BOTTOM STANDARD MOUNTING (TBSM)  
IISNS DETAIL N.T.S.

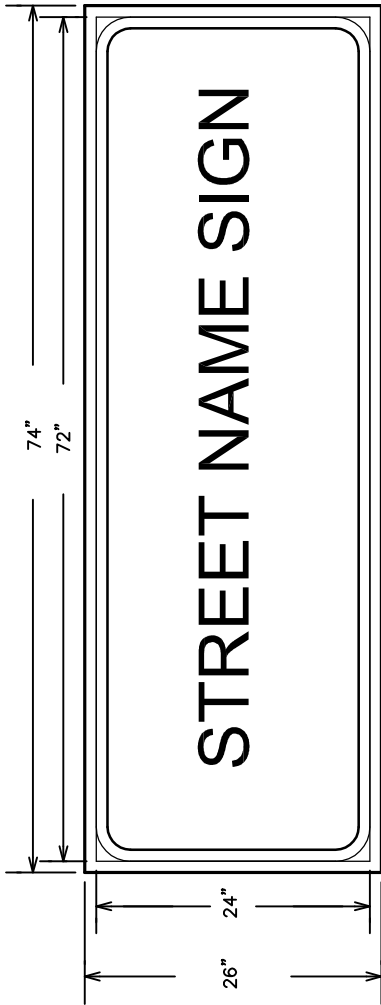

Side View

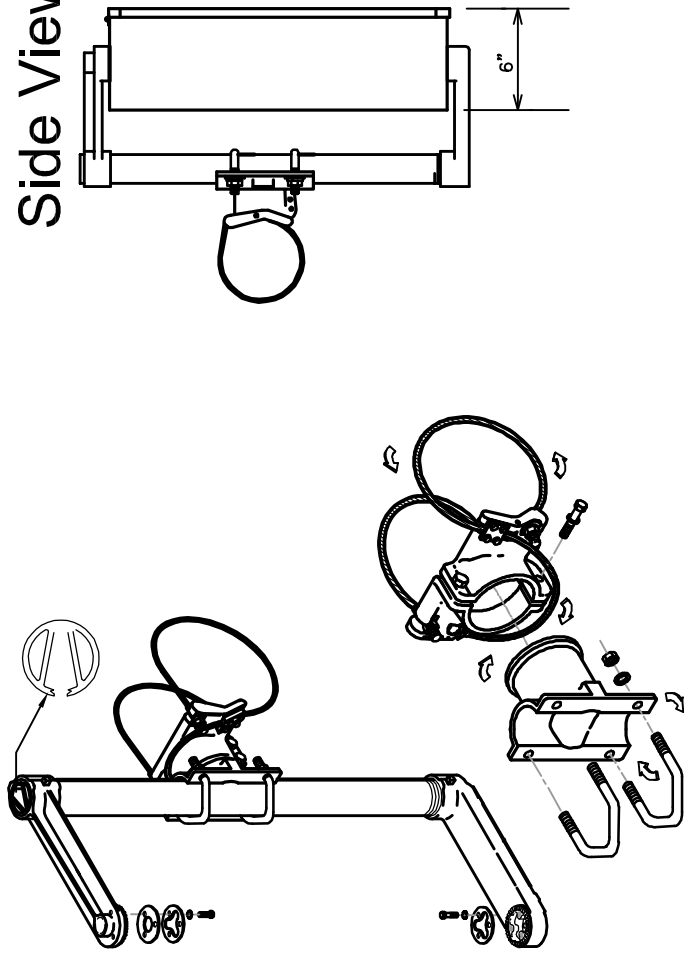

Note: All installation procedures shall follow Traffic Control Equipment Specifications and Standards (TCES) and National Electrical Code (NEC).

TOP/BOTTOM STANDARD MOUNTING (TBSM)  
IISNS DETAIL N.T.S.

# SIDE VIEW

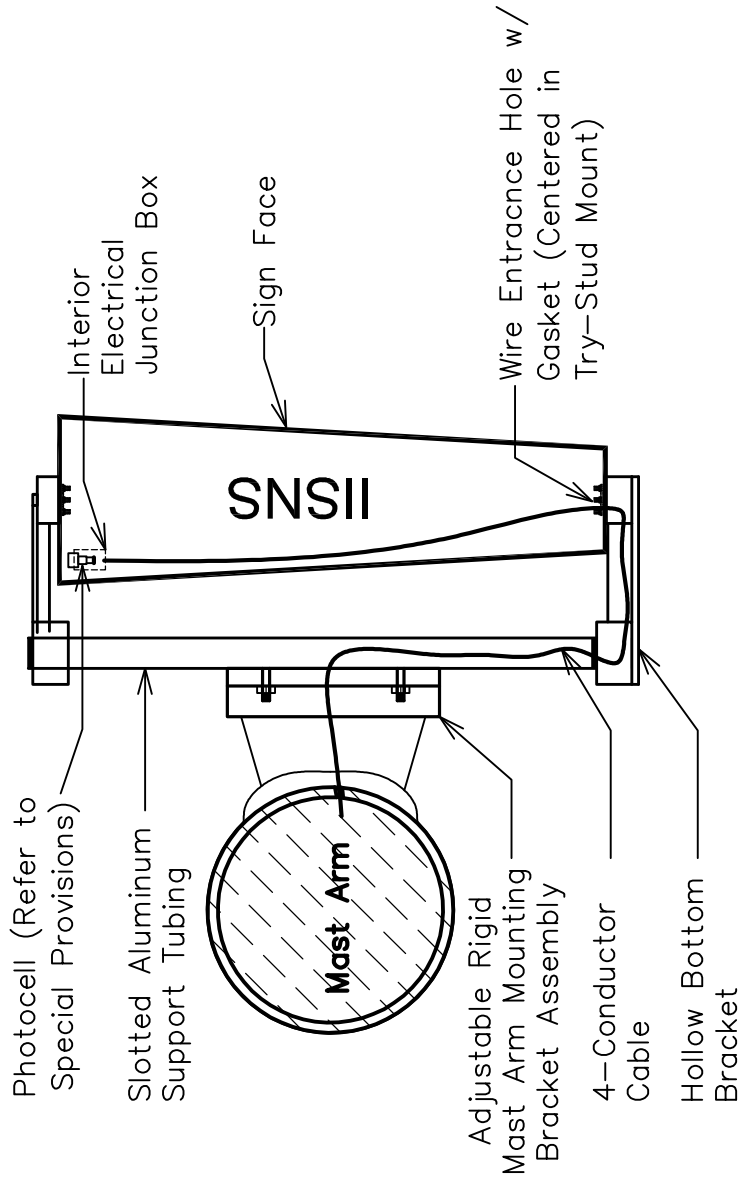

Note: All installation procedures shall follow Traffic Control Equipment Specifications and Standards (TCESS) and National Electrical Code (NEC).

## TOP/BOTTOM STANDARD MOUNTING (TBSM) IISNS DETAIL N.T.S.



# FRONT VIEW

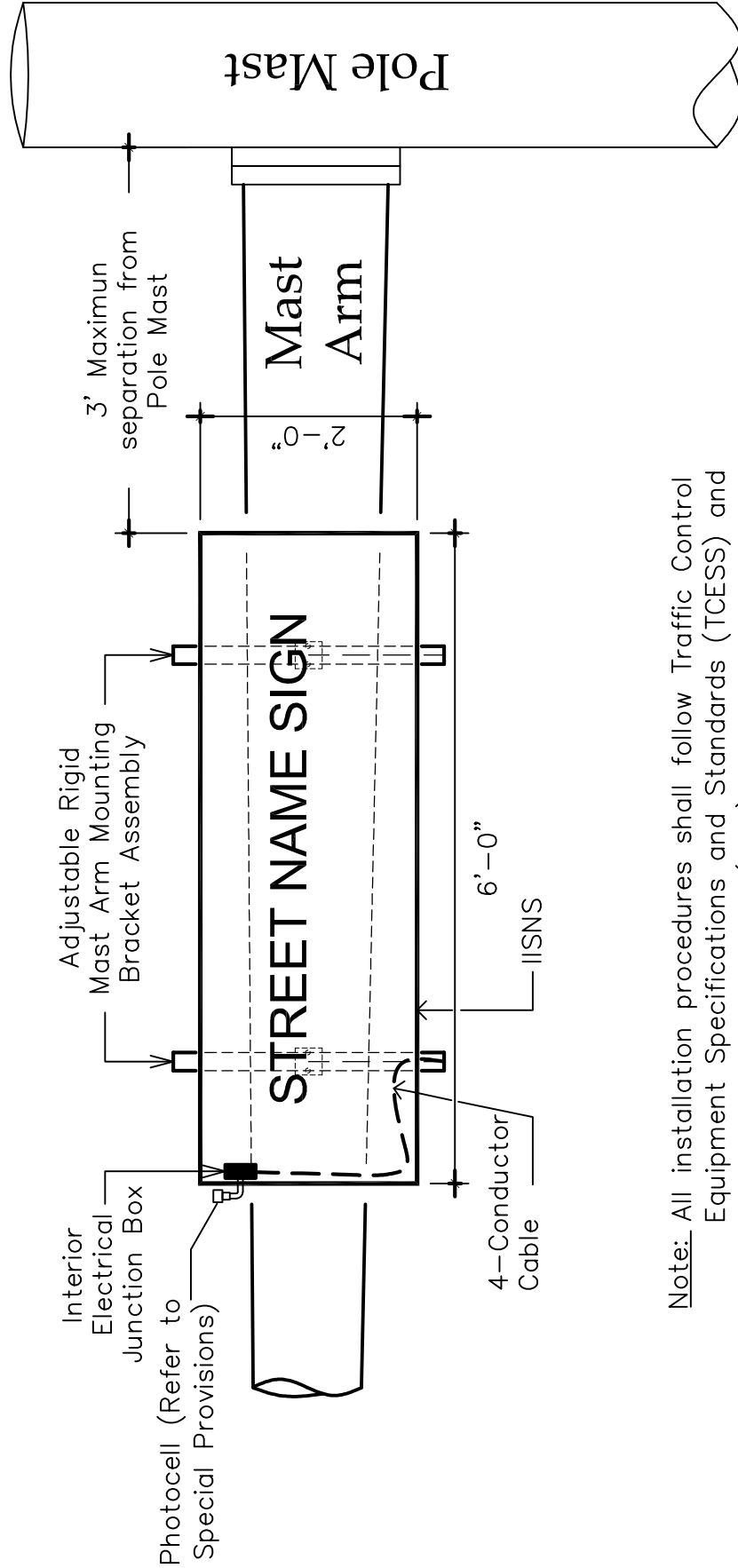

Note: All installation procedures shall follow Traffic Control Equipment Specifications and Standards (TCESS) and National Electrical Code (NEC).

## TOP/BOTTOM STANDARD MOUNTING (TBSM) 11SNS DETAIL N.T.S.

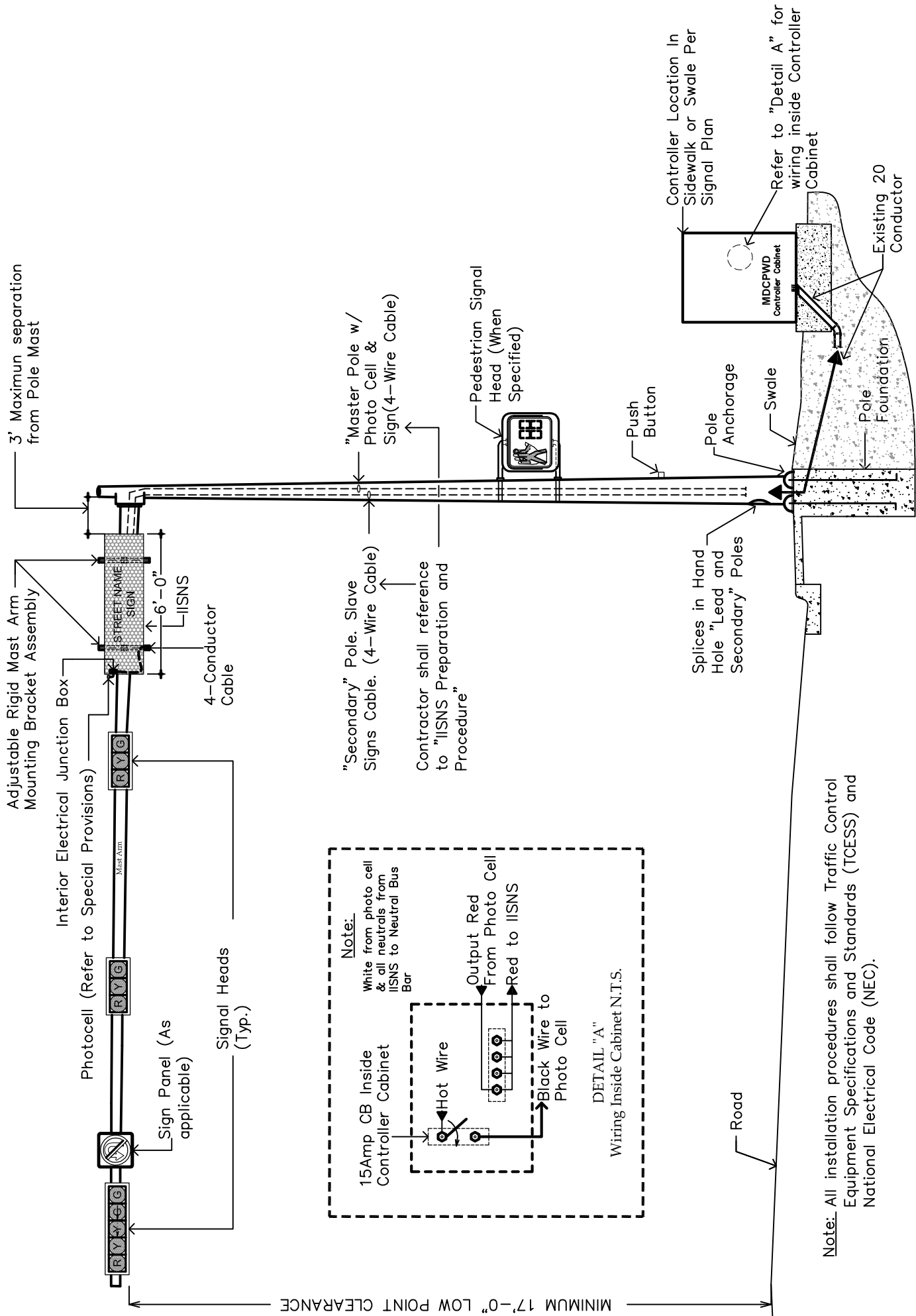

MINIMUM 17'-0" LOW POINT CLEARANCE

Note: All installation procedures shall follow Traffic Control Equipment Specifications and Standards (TCESS) and National Electrical Code (NEC).

TYPICAL IISNS WIRING DIAGRAM N.T.S.

APPENDIX "P" TO SPECIAL PROVISIONS  
"LED PEDESTRIAN COUNTDOWN MODULE (16"X18")" FUNCTIONAL  
SPECIFICATIONS

**MIAMI-DADE COUNTY PUBLIC WORKS DEPARTMENT  
FUNCTIONAL SPECIFICATION LED PEDESTRIAN  
COUNTDOWN MODULE (16" X 18")**

**1.0 General**

- 1.1 The LED pedestrian countdown module shall be as a retrofit replacement for existing modular neon module shall not require special tools for installation.
- 1.2 The LED countdown module shall fit into existing 16" x 18" traffic signal housing built to ITE VTCSH standards without modification to the housing.

**2.0 Environmental**

- 2.1 The LED countdown module shall be rated for use in the ambient operating temperature range of -40°C (-40°F) to + 74°C (+165°F).
- 2.2 The LED countdown module shall be completely sealed against dust and moisture intrusion per the requirement of NEMA Standard 250 – 1991 sections 4.7.2.1 and 4.7.3.2 for type 4 enclosures to protect all internal components.

**3.0 Construction**

- 3.1 The LED countdown module shall be a single, self-contained device, not requiring on-site assembly for installation into existing traffic signal housings.
- 3.2 The assembly of the LED countdown module shall be designed to assure all internal components are adequately supported to withstand mechanical shock and vibration from high winds and other sources.
- 3.3 The AC power wires for the Hand/Person portion of the signal and the Countdown Timer portion of the signal shall be secured, color coded (blue, orange, white), 39 inch long, 600V, 18 AWG anti-capillary wires or approved equivalent, and rated for service at + 105°C. Three wires (blue, orange, white) shall be provided for electrical connection to the Hand/Person portion of the module, and separate set of three wires (blue, red, white) shall be provide for electrical connection to the Countdown Timer portion of the module.
- 3.4 The LED signal module lens shall have a slightly textured surface to reduce glare.

**4.0 Chromaticity**

- 4.1 The measured chromaticity coordinates for the "white" walking person and the "Portland Orange" Hand and digits shall conform to the chromaticity requirements of section 8.04 and Figure 1 of the VTCSH standard.
- 4.2 The chromaticity measurements shall remain unchanged over the input line voltage range of 80 VAC to 135 VAC.

**5.0 Display**

- 5.1 The LED countdown signal module shall consist of a double overlay message combining the symbols of a Hand and Walking Person and two "7 segment" digits forming the time display.
- 5.2 The Pedestrian icon LEDs shall be arranged in a manner to form solid icon symbols. The shape of the symbols shall conform to the standard symbols for pedestrian signals.
- 5.3 The LED's shall be distributed evenly in each Pedestrian icon. The distance between each LED shall be evenly spaced.

- 5.4 The Hand/Person symbols shall be not less than 11" in height and 6.5" in width.
- 5.5 The countdown digits shall be 9" high, and shall be MUTCD compliant for crosswalks over 100 feet.
- 5.6 The countdown digits shall consist of two rows of LEDs in a staggered configuration, producing rounded numeral corners. Each of the two "7-segment" digit.
- 5.7 The "Portland Orange" LED's shall be of the latest AlInGaP technology and the "white" LED's of the latest InGan technology.
- 5.8 The individual LED light sources shall be interconnected so that a catastrophic failure of a single LED will result in a total loss of not more than 3 LED's or 5% of the signal light output.
- 5.9 The luminous output of the Hand/Person symbols and the Countdown numerals shall not vary more than 10% over the voltages range specified in Sec. 6.2, and shall not be perceptible to the human eye.

## **6.0 Drive Circuitry**

- 6.1 The LED's shall be driven at a DC current not exceeding the maximum rating recommended by the LED manufacturer.
- 6.2 The LED drive current on both Hand and Person messages shall be regulated to compensate for line voltage fluctuations over the range of 80VAC to 135 VAC.
- 6.3 The turn-on/turn-off time for the Hand/Person shall be 75ms or less.
- 6.4 The Total Harmonic Distortion induced into an AC power line LED signal module, when operated at nominal operating voltage and at an ambient temperature of 25°C (77°F), shall not exceed 20 percent.
- 6.5 The signal shall provide a power factor of 0.90 or greater when operated at nominal operating and at 25°C (77°F).
- 6.6 The drive circuitry shall include voltage surge protection to withstand high-repetition noise transients and low-repetition high-energy transients as stated in Section 2.1.6 and Section 2.1.8 of NEMA Standard TS-2, 1992.
- 6.7 The on-board circuitry shall meet FCC title 47, Sub-Part B, Section 15 regulations concerning the emission of electronic noise.
- 6.8 The typical power consumption for the Hand shall be 6W, the typical power consumption for the Person shall be 7W and the typical power consumption for countdown shall be 5W.
- 6.9 The circuitry shall ensure compatibility and proper triggering of load switches and conflict monitors in signal controllers currently in use by the procuring traffic authority.
- 6.10 The pedestrian countdown signal shall not be illuminated by input signals under 35 VAC.
- 6.11 The Countdown Timer portion of the signal shall have a high "of state" input impedance so as not to provide a load indication to conflict monitors and interfere with the monitoring of the pedestrian signals. The input impedance of the countdown circuitry shall maintain a voltage reading above 25 VAC to the conflict monitor for a minimum of 4 units connected on the same channel.
- 6.12 The Countdown Timer drive circuitry shall not be damaged when subjected to defective load switched providing a half wave signal output.

## **7.0 Countdown Functionality**

- 7.1 The countdown module shall be compatible with controllers that are compliant to NEMA TS-1, NEMA TS-2, Type 170 207 controller specifications.

- 7.2 The countdown timer module shall have a micro-processor capable of recording its own time when connected to a traffic controller.
- 7.3 When connected, the module shall blank out the display during the initial cycle while it record the countdown time using the Walk & D/Walk signal indications.
- 7.4 The countdown timer shall continuously monitor the traffic controller for any changes to the pedestrian phase time and re-program itself automatically if needed.
- 7.5 The countdown module shall register the time for the walk and clearance intervals individually and shall begin counting down a the beginning of the pedestrian change interval.
- 7.6 When the flashing Hand becomes solid, the module shall display 0 and then blank-out. The display shall remain dark until the beginning of the next countdown.
- 7.7 In the event of a pre-emption sequence, the countdown module shall skip the pre-empted clearance time and reach 0 when the flashing Hand becomes solid.
- 7.8 In the cycle following a pre-emption call, the signal shall display the correct time and not be affected by the reduced previous cycle. The countdown shall remain synchronized with the signal indication and always reach 0 at the same time as the flashing Hand becomes solid.
- 7.9 The countdown timer shall be capable of timing 2 consecutive complete pedestrian cycles outputted by the traffic controller (no steady Hand signal between cycles)
- 7.10 The countdown module shall an internal conflict monitor preventing any possible conflicts between the Hand/Person signal indications and the Countdown Timer display. It shall be impossible for the display to countdown during a solid Hand indication.
- 7.11 The countdown module shall only be capable of counting down the clearance timer clearance interval.

## **8.0 Warranty**

- 8.1 Manufacturers shall provide a written warranty issued by the factory located in the NAFTA country of module origin with the following minimum provision:
- 8.2 Modules shall be repaired or purchase value refunded if the module fails to function as intended due to workmanship or material defects within the first sixty (60) months from the date of delivery.
- 8.3 Modules which exhibit luminous intensities less than the minimum specified values within the first sixty (60) months of the date of delivery shall be replaced, repaired or purchase value refunded.
- 8.4 Upon request, the LED lamp module manufacture shall provide written documentation of its ability to satisfy a worst-case, catastrophic warranty claim. A current corporate annual report duly-certified by an independent auditing firm, containing financial statement illustrating sufficient cash-on-hand and net worth to satisfy a worst-case, catastrophic warranty claim is an example of suitable documentation. The document shall clearly disclose:
  - a)The country in which the factory of module origin is located
  - b)The name of the company or organization that owns the factory of module origin including any and all of its parent companies and/or organizations, and their respective county of corporate citizenship.
  - c)For firms with business and/or corporate citizenship in the United States of less than seven years, the process by which the end-users/owners of the modules will be able to obtain worst-case, catastrophic warranty service in the event of bankruptcy or cassation-of-operations by the firm supplying within North America, or in the event of bankruptcy or cessation-of-operations by the owner of the factory of origin, shall be clearly disclosed.

APPENDIX "Q" TO SPECIAL PROVISIONS  
SCHOOL ZONE SPEED LIMIT BEACON ASSEMBLY DETAIL DRAWINGS

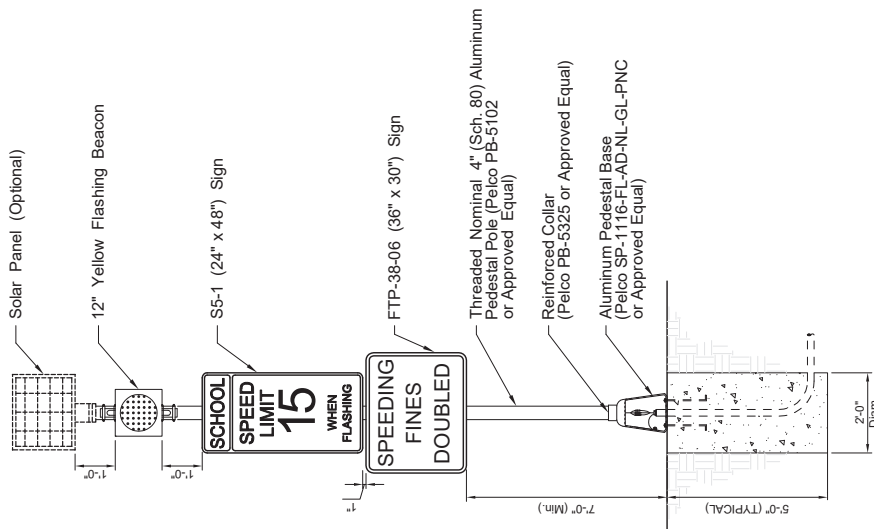

FRONT VIEW

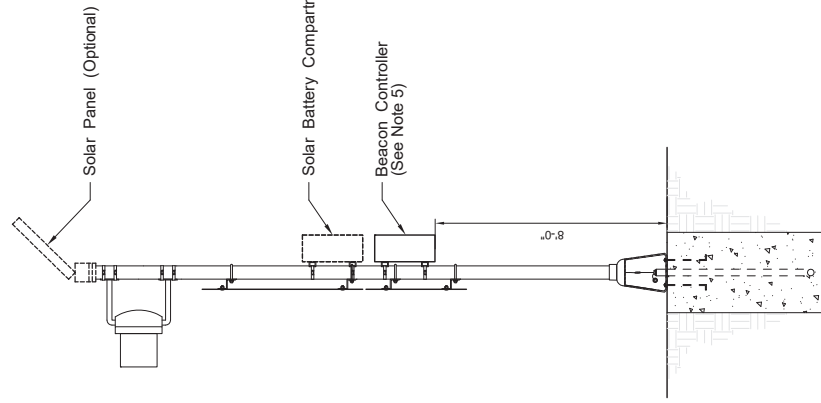

SIDE VIEW

**NOTES:**

1. MEET THE REQUIREMENTS OF SECTION 700 (HIGHWAY SIGNING) OF THE FLORIDA DEPARTMENT OF TRANSPORTATION'S STANDARD SPECIFICATIONS FOR ROAD AND BRIDGE CONSTRUCTION.
2. MEET THE SIGN MOUNTING HARDWARE REQUIREMENTS OF FDOT STANDARD PLANS INDEX 700-010 (SINGLE COLUMN GROUND SIGNS).
3. ENGINEER OF RECORD MUST ENSURE THAT THE PROPOSED SIGN ASSEMBLIES AND FOUNDATION ARE DESIGNED TO WITHSTAND ALL APPLICABLE WIND LOADS.
4. USE ASSEMBLIES AND COMPONENTS THAT ARE LISTED ON THE FOOT ARL AND THE MIAMI DADE COUNTY TSSOR. DETAILS DEPICT OPTIONAL EQUIPMENT NEEDED FOR SOLAR POWERED INSTALLATIONS. THE BEACON CONTROLLER AND BATTERIES MAY BE IN THE SAME CABINET IF CONSISTENT WITH ITS PRODUCT APPROVAL.
5. A PEDESTAL POLE AND TRANSFORMER BASE IS REQUIRED FOR BOTH AC AND SOLAR POWERED ASSEMBLIES. SEE DETAILS ON SHEET 3 FOR GROUNDING AND WIRING REQUIREMENTS.
6. PEDESTAL BASE REQUIRES ANCHOR BOLT CAGE DEPICTED IN THE DETAILS ON SHEET 3.

DATE: 12/8/17  
REVISION:

DESCRIPTION: TRAFFIC CONTROL EQUIPMENT STANDARDS AND SPECIFICATIONS



DTPW TRAFFIC SIGNALS AND SIGNS DIVISION  
7100 NW 36th STREET  
MIAMI, FLORIDA 33166  
305-592-3880

DATE	NAME	APPROVED BY:
12-8-17	LUIS DIAZ	FRANK ARA, P.E.
	MIAMI-DADE COUNTY	

SCHOOL ZONE SPEED LIMIT BEACON ASSEMBLY DETAILS (N.T.S.)

SHEET NO. 1 OF 3



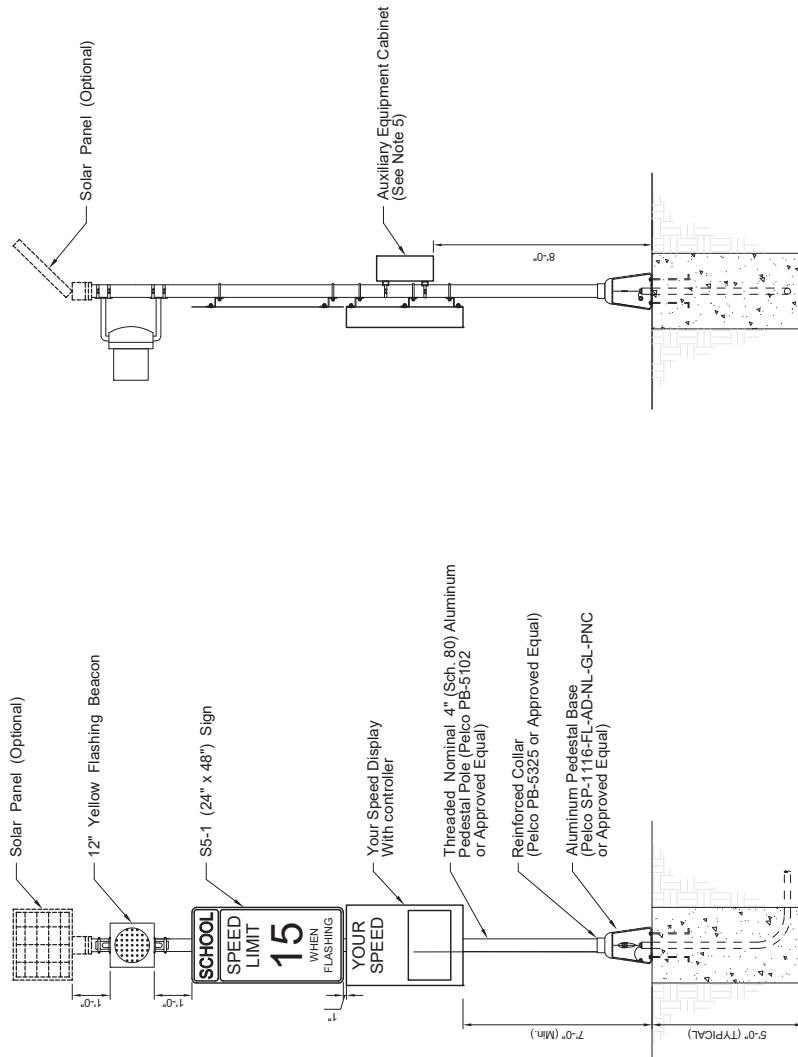

FRONT VIEW

SIDE VIEW

**NOTES:**

1. MEET THE REQUIREMENTS OF SECTION 700 (HIGHWAY SIGNING) OF THE FLORIDA DEPARTMENT OF TRANSPORTATION'S STANDARD SPECIFICATIONS FOR ROAD AND BRIDGE CONSTRUCTION.
2. MEET THE SIGN MOUNTING HARDWARE REQUIREMENTS OF FOOT STANDARD PLANS INDEX 700.010 (SINGLE COLUMN GROUND SIGNS).
3. DETAILS DEPICTED WITH SPEED FEEDBACK SIGN DISPLAY WITH NUMERICAL HEIGHTS OF 15 FOR USE IN AREAS WITH POSTED SPEEDS LESS THAN 45 MPH.
4. ENGINEER OF RECORD MUST ENSURE THAT THE PROPOSED SIGN ASSEMBLIES AND FOUNDATION ARE DESIGNED TO WITHSTAND ALL APPLICABLE WIND LOADS.
5. USE ASSEMBLIES AND COMPONENTS THAT ARE LISTED ON THE FOOT APL AND THE MIAMI/DADE COUNTY TSSOR. DETAILS DEPICT OPTIMAL EQUIPMENT NEEDED FOR SOLAR POWERED INSTALLATIONS. THE BEACON CONTROLLER AND BATTERIES MAY BE IN THE SAME CABINET IF CONSISTENT WITH ITS PRODUCT APPROVAL.
6. A PEDESTAL POLE AND TRANSFORMER BASE IS REQUIRED FOR BOTH AC AND SOLAR POWERED ASSEMBLIES. SEE DETAILS ON SHEET 3 FOR GROUNDING AND WIRING REQUIREMENTS.
7. PEDESTAL BASE REQUIRES ANCHOR BOLT CAGE DEPICTED IN THE DETAIL ON SHEET 3.

DESCRIPTION:  
 BEST REVISION  
 12/11/17

TRAFFIC CONTROL EQUIPMENT  
 STANDARDS AND SPECIFICATIONS



DTPW TRAFFIC SIGNALS AND SIGNS DIVISION  
 MIAMI, FLORIDA 33166  
 305-592-5380

DATE	12-11-17
NAME	USE ONLY
ISSUED FOR	ISSUED FOR
APPROVED BY	APPROVED BY

SCHOOL ZONE SPEED LIMIT  
 BEACON ASSEMBLY WITH ESFS  
 DETAILS (N.T.S.)

SHEET NO.  
 2 OF 3

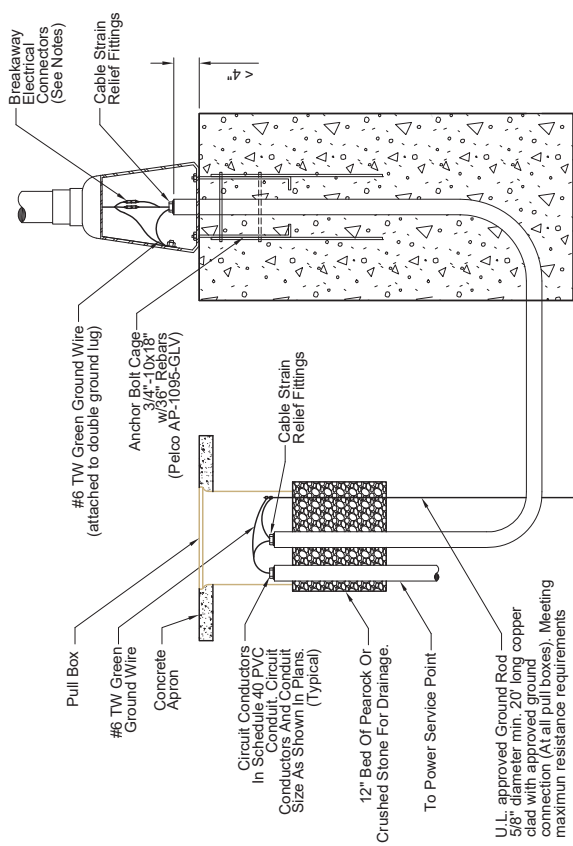

Notes:

1. Fuses: Class CC, 600 VAC, 15 Amps, current limiting, time-delay, UL listed, 200KA VAC RMS Sym. interrupting Rating; Limitron™, Class CC FNQ-R-15 or approved equal.
2. Single-Pole In-Line Fuse Holder with solid Breakaway Option for impact separation: Rated 30A, 600V; Limitron™, HEB-AW-RLC-J for the fused disconnect and HET-AW-RLC-J having a permanently installed solid neutral (for the non-fused disconnect), or approved equal.
3. Cord must be SOW or SOOW type with a 600V rating, minimum 12 AWG.

**POLE GROUND DETAIL  
SOLAR POWERED BEACON**

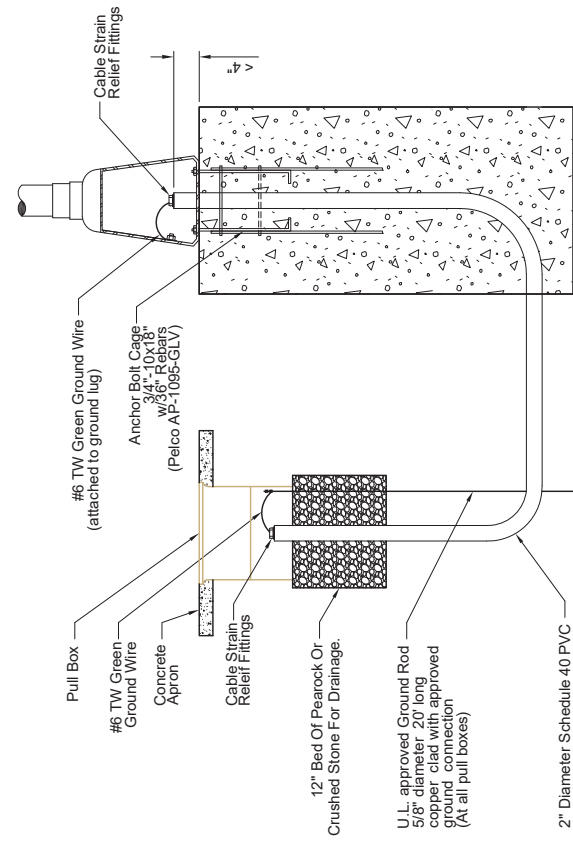

DATE 12/8/17	DESCRIPTION: TRAFFIC CONTROL EQUIPMENT STANDARDS AND SPECIFICATIONS	 DTPW TRAFFIC SIGNALS AND SIGNS DIVISION 7100 NW 38th STREET MIAMI, FL 33149 305-592-3400	<table border="1"> <tr> <th>TEAM</th> <th>NAME</th> <th>DATE</th> </tr> <tr> <td>DESIGNED BY</td> <td>LUZ DIAZ</td> <td>12-2-17</td> </tr> <tr> <td>CHECKED BY</td> <td>MARK FERNANDEZ</td> <td></td> </tr> </table>	TEAM	NAME	DATE	DESIGNED BY	LUZ DIAZ	12-2-17	CHECKED BY	MARK FERNANDEZ		BEACON ASSEMBLY PEDESTAL POLE WIRING DETAILS (N.T.S.)	SHEET NO.
				TEAM	NAME	DATE								
DESIGNED BY	LUZ DIAZ	12-2-17												
CHECKED BY	MARK FERNANDEZ													
3 OF 3														

APPENDIX "R" TO SPECIAL PROVISIONS  
LOOP ASSEMBLY INDUCTANCE AND RESISTANCE TEST

**Miami-Dade County Public Works and Waste Management Department**

**Traffic Signals and Signs Division**

**Loop Assembly Inductance and Resistance Test**

(Complete entire Form and deliver to Engineer prior to Inspection)

Asset No.: \_\_\_\_\_ Project No.: \_\_\_\_\_ Contractor: \_\_\_\_\_

Location: \_\_\_\_\_

(L is inductance in microhenries;  $R_s$  is series resistance in Ohms;  $R_p$  is Insulation Resistance in megohms; Q is Loop Quality Factor)

**Loop Wire (including twisted Lead-in Wire) measured at Junction Box**

* To be filled out by Designer or Engineer			Before and After Sealing Saw cut				RESULTS**
Loop #	L *	$R_s$ *	L	$R_s$	$R_p$	Q	Pass /Fail
1							
2							
3							
4							
5							
6							
7							
8							
9							
10							
11							
12							

**Loop Assembly (Loop Wire and Shielded Lead-in Cable) measured at Control Cabinet**

* To be filled out by Designer or Engineer								RESULTS**
Loop #	Loop Location	L *	$R_s$ *	L	$R_s$	$R_p$	Q	Pass /Fail
1								
2								
3								
4								
5								
6								
7								
8								
9								
10								
11								
12								

**Equipment Used:** Loop Analyzer Manufacturer \_\_\_\_\_ Model \_\_\_\_\_  
 Megger Manufacturer \_\_\_\_\_ Model \_\_\_\_\_

\*\*The undersigned certifies that the loop assemblies were installed pursuant to all applicable specifications, meet all requirements specified therein (unless otherwise recorded on this Form), and that the above tests were performed pursuant to acceptable industry standards.

**Test Completed By:**

**Witness:**

\_\_\_\_\_  
 Signature of Contractor Representative  
 (Traffic Signal Level II, IMSA)

\_\_\_\_\_  
 Date

\_\_\_\_\_  
 Signature

\_\_\_\_\_  
 Print Name

\_\_\_\_\_  
 Print Name

\_\_\_\_\_  
 IMSA Certification No.

APPENDIX "S" TO SPECIAL PROVISIONS

SECTION 700- ROADWAY SIGNS

## **SECTION 700 ROADWAY SIGNS**

### **PART 1 GENERAL**

#### **1.01 SUMMARY**

- A. Furnish and erect roadway signs at the locations and in accordance with the details shown in the Plans unless otherwise referenced herein. These include roadway static sign assemblies, Internally Illuminated Street Name Signs, Electronic Display Sign assemblies, and Sign Beacon assemblies.
  
- B. Related Sections
  - 1. Section 630 (Conduit)
  - 2. Section 635 (Pull, Splice, and Junction Boxes)
  - 3. FDOT Specification Section 620 (Grounding and Lightning Protection)
  - 4. FDOT Specification Section 646 (Aluminum Poles, Pedestals, And Posts)
  - 5. FDOT Specification Section 676 (Controller Cabinets)
  - 6. FDOT Specification Section 700 (Highway Signing)
  
- C. Method of Measurement
  - 1. General:
    - a. Unless otherwise specified herein, a completed assembly includes all materials, equipment, and labor necessary for a complete, functional and accepted installation.
    - b. The cost of furnishing and installing the required installation decals is considered incidental and is included in the unit prices for the signs or assemblies.
    - c. The cost for documenting and returning removed sign panels and assemblies to the Traffic Signals and Signs Division's Yard is considered incidental and is included in the unit prices for removal.
  - 2. Roadway Static Sign Assembly (ground-mounted).
    - a. Single/Multi Post Sign Assembly items: A completed assembly includes the support structure and all the sign panels required to be mounted on the support structure. The Contract unit price per assembly for ground mounted signs (single post and multi-post), furnished and installed, includes furnishing and installing the sign panels, support structure, foundation, hardware, appurtenances, and labor required for a complete and accepted installation.
    - b. Single/Multi Post Sign Assembly Relocation/Removal items: Relocation of sign assembly consists of removing the existing sign assembly and installing the assembly on a new foundation at the location shown in the Plans. When the Plans call for existing ground-mounted signs to be relocated or removed, after removing the sign panel(s) from the assembly, remove support(s) and footing(s). Restore the area of the sign assembly removal or relocation to the condition of the adjacent area at no additional cost.
    - c. Sign Panel Pay Items:

- 1) Pay items for adding/removing sign panel are used only when adding/removing a panel to/from an existing support structure that will remain in place. Adding sign panel requires the use of new attachment hardware. For new single post and multi-column signs, all panels on a new assembly are included in the payment for the assembly. No additional payment will be made for adding/removing panels on single/multi post sign assembly where the entire assembly has been relocated or removed.
- 2) Relocation of sign panels includes new attachment hardware for mounting the relocated signs onto existing support structures as indicated on the Plans.
3. Internally Illuminated Street Name Sign (IISNS).
  - a. Contract unit price per each for IISNS, furnished and installed, will include furnishing the sign panels, housing, hardware, electrical connection, photocontrol, and labor necessary for a complete and accepted installation.
  - b. Includes all hardware necessary to complete the attachment to the mast arm structure as required by the Contract Documents.
4. Electronic Display Sign Assembly (EDS).
  - a. EDS refers to a general category of electronically enhanced signs that includes electronic speed feedback signs and blank-out signs.
  - b. The Contract unit price per assembly for EDS, furnished and installed, includes the sign panels, electronic display, housing, cabinet, controller, speed detector, hardware, electrical connection, wiring, appurtenances, and labor necessary for a complete, functional, and accepted installation as required by the Contract Documents. When the EDS is ground mounted, the Contract unit price includes the sign support structure, conduit, pull box, grounding, and foundation. When the EDS is mounted on span wire or mast arm, the Contract Unit Price includes the hardware necessary to complete the attachment to the support structure; the span wire or mast arm structure will be paid separately.
  - c. In addition:
    - 1) For AC powered assembly does not include the cost of the Electrical Power Service Assembly.
    - 2) For solar powered assembly, price includes solar panels and all components for a complete and functional solar powered installation.
5. Sign Beacon Assembly.
  - a. The Contract unit price per assembly for sign beacon assembly includes the beacons, sign panels, cabinet, electronics, wiring, all necessary appurtenances, and labor necessary for a complete, functional, and accepted installation as required by the Contract Documents. When the sign beacon assembly is ground mounted, the Contract unit price includes the sign support structure, conduit, pull box, grounding, and foundation. When the sign beacon is mounted on span wire or mast arm, the Contract Unit Price includes the hardware necessary to complete the attachment to the support structure; the span wire or mast arm structure will be paid separately.
  - b. In addition:
    - 1) For AC powered beacon assembly, does not include the cost of the Electrical Power Service Assembly.
    - 2) For solar powered beacon assembly, price includes solar panels and all components for a complete and functional solar powered installation.

- 3) For beacon assembly intended for use with school zone signing, price includes equipment approved by the Department for centralized remote calendar programming of days and times of operation.
- 4) For vehicle-activated sign beacon assembly, price includes vehicle detection system listed on the FDOT APL and the TSSQPL.
- 5) For pedestrian-activated sign beacon assembly, price includes a pedestrian detector listed on the FDOT APL and the TSSQPL.
- 6) For warning beacons assembly operated from a wired input received from traffic signal cabinet to temporarily actuate beacons ahead of a change in signal phase, single cable and conduit from the signal cabinet to the sign beacon will be paid separately under the applicable pay items and Specifications in the Contract Documents.

#### D. Basis of Payment

1. Price and Payment will be full compensation for all work specified in this Specification Section that have awarded Contract Unit Prices under the following items:

Pay Item	Description	Unit
700-1-11B	Single Post Sign, F&I Ground Mount, Up To 12 SF	AS
700-1-12C	Single Post Sign, F&I Ground Mount, 12-20 SF	AS
700-1-50	Single Post Sign, Relocate	AS
700-1-60	Single Post Sign, Remove	AS
700-2-12	Multi- Post Sign, F&I Ground Mount, 12-20 SF	AS
700-2-50	Multi- Post Sign, Ground Mount, Relocate	AS
700-2-60	Multi- Post Sign, Remove	AS
700-3-101	Sign Panel, F&I Ground Mount, Up To 12 SF	EA
700-3-102	Sign Panel, F&I Ground Mount, 12-20 SF	EA
700-3-201	Sign Panel, F&I Overhead Mount, Up To 12 SF	EA
700-3-202	Sign Panel, F&I Overhead Mount, 12-20 SF	EA
700-3-203	Sign Panel, F&I Overhead Mount, 21-30 SF	EA
700-3-204	Sign Panel, F&I Overhead Mount, 31-50 SF	EA
700-3-501	Sign Panel, Relocate, Up To 12 SF	EA
700-3-502	Sign Panel, Relocate, 12-20 SF	EA
700-3-503	Sign Panel, Relocate, 21-30 SF	EA
700-3-601	Sign Panel, Remove, Up To 12 SF	EA
700-3-602	Sign Panel, Remove, 12-20 SF	EA
700-5-21	Internally Illuminated Sign, F&I Overhead Mount, Up To 12 SF	EA
700-5-60	Internally Illuminated Sign, Remove	EA
700-11-139	Electronic Display Sign, F&I Ground Mount- AC Powered, Speed Feedback Sign	AS



Pay Item	Description	Unit
700-11-239	Electronic Display Sign, F&I Ground Mount- Solar Power, Speed Feedback	AS
700-11-391	Electronic Display Sign, F&I Overhead Mount- AC Powered, Blank Out Sign, Up To 12 SF	AS
700-12-11	Sign Beacon, F&I Ground Mount- AC Powered, One Beacon	AS
700-12-12	Sign Beacon, F&I Ground Mount- AC Powered, Two Beacons	AS
700-12-21	Sign Beacon, F&I Ground Mount- Solar Powered, One Beacon	AS

**1.02 REFERENCES**

- A. Miami-Dade County Traffic Signals and Signs Division’s Qualified Product List (TSSQPL)
- B. FDOT Approved Product List (APL)
- C. Miami-Dade County’s Public Works Manual, Standard Road Detail Sheets R18.1
- D. American Society for Testing and Materials (ASTM)
- E. FHWA Manual on Uniform Traffic Control Devices (MUTCD)
- F. National Electrical Code, NFPA 70 (NEC)

**1.03 DELIVERY STORAGE AND HANDLING**

- A. Storage, Handling and Labeling:
  - 1. Storage and handling:
    - a. If signs are stored prior to installation, store them in accordance with the manufacturer’s recommendations. Properly package signs to protect them during storage, shipment and handling to prevent damage to the sign face and panel.
  - 2. Installation Decals:
    - a. In addition to the information required in FDOT Specification Section 994, all permanent roadway signs (new, repaired or relocated) must be labeled on the back lower right-hand corner with the date of installation, repair or relocation punched out. The decal must not be placed over any existing installation decal.
    - b. Decals must be manufactured from Type II (ASTM D4956) sheeting with black legend and yellow reflectorized background. The decal must show information that includes the date of installation, repair, or relocation; the name “Miami-Dade County, Florida”; the relevant Florida Statutes and associated fine for sign tampering and the telephone number for reporting damaged or missing signs.
    - c. Make the labels unobtrusive, but legible enough to be easily read by an observer on the ground when the sign is in its final position. Apply the label in a manner that is at least as durable as the sign face.

**1.04 ACCEPTANCE OF SIGNS**

- A. Sign Inspection:

1. Submit certification that the sign assembly meets the material and installation requirements of the Contract Documents and the approved Shop Drawings. Engineer will inspect the signs at the final construction inspection. Repair and replace signs deemed unacceptable by Engineer at no expense to the Department.

B. Certification of Conformance:

1. Provide a Certificate of Conformance with a notarized Affidavit specifying the alloy and domestic source origin of aluminum signs.
2. Provide a certification that all signs, materials, and installation are in strict accordance with the requirements of this Specification Section.

## 1.05 SYSTEM DESCRIPTION

A. Design Requirements

1. Engineer of Record must ensure that the proposed sign assemblies and foundation are designed to withstand all applicable loads and meet performance requirements.
2. Electronic Display Signs
  - a. Electronic Speed Feedback Signs (ESFS).
    - 1) Plans must include a schedule listing the programming parameters for the ESFS including Speed Limit, Violation Alert Speed, "SLOW DOWN" Speed, High Speed Cutoff Function (Blank Display), High Speed Cutout Speed, and Minimum Display Speed.
    - 2) ESFS in a school zone may only operate while the speed limit is in effect in the zone. Otherwise the display must be blank.
  - b. Blank-Out Signs (BOS).
    - 1) Plans must include operational details pertaining to all display phases and blank-out phases.
    - 2) Plan details must depict exact mounting location in relation to other traffic signal components and signs on the Mast Arm.

B. Performance Requirements

1. The sign assembly for IISNS, Sign Beacon Assembly, and EDS must be designed and constructed to meet the requirements of FDOT's Structures Manual using a Design Wind Speed of 150 mph.
2. Manufacturer must provide engineering certification that the assembly's major components along with the recommended attachments for mounting on a 4.5" outer diameter pole (Sign Beacon and EDS Assembly) and other support structures (Mast Arms and Span Wire), meet the load requirements of Section 3 of AASHTO LTS-6 as modified by FDOT Structures Manual Volume 3 using a Basic Wind Speed (V) of 150 mph in the determination of the design wind pressure.

## 1.06 WARRANTY

A. Special Warranty

1. Flashing Beacons and EDS Assemblies: Ensure all EDS, IISNS, and flashing beacon systems have a manufacturer's warranty covering defects in assembly, fabrication, and materials for a minimum of five years from the date of final acceptance. Ensure

the manufacturer will furnish replacements for any part or equipment found to be defective during the warranty period at no cost to the Department within 30 calendar days of notification. In addition, ESFS must include a manufacturer's warranty of ten (10) years on the LEDs, comprising the display segments, from the date of final acceptance.

2. Outbound shipping costs for warranty replacements parts must be paid for by the manufacturer. All control software and firmware updates must be available to the County at no additional charge, during the warranty period.
3. Manufacturer must also provide technical telephone support at no extra charge to the County including replacement components for in-warranty repairs when provided in exchange for the part being replaced.

## PART 2 PRODUCTS

### 2.01 MATERIALS AND EQUIPMENT

#### A. General:

1. Meet the material and equipment requirements of this Specification Section and any additional requirement stipulated in the Contract Documents.
2. Meet the Sign Fabrication requirements of FDOT Specification Section 700 (Highway Signing).
3. Meet the Storage, Handling and Labeling requirements of FDOT Specification Section 700 (Highway Signing).

#### B. Concrete:

1. Use concrete meeting the requirements of FDOT Specification Section 346.
2. Obtain concrete from a plant that is listed on the FDOT's Production Facility Listing.

#### C. Sign Panels.

1. All sign panels must be aluminum unless otherwise shown in the Plans.
2. Sheets and plates for sign panels must meet the requirements of ASTM B209, Aluminum Association Alloy 6061-T6, 5154-H38 or 5052-H38. Sign panels for single column ground mounted signs must utilize aluminum plate with a minimum thickness of 0.08 inches. All other sign panels must utilize aluminum plate with a minimum thickness of 0.125 inches. All panels shall have rounded corners.

#### D. Retroreflective Sign Sheeting.

1. Meet the retroreflective sign sheeting requirements of FDOT Section 700 (Highway Signing).

#### E. Roadway Static Sign Assembly (ground-mounted).

1. Mounting Hardware and Posts for Static Signs Only:
  - a. Unless otherwise specified in the Plans, for static roadway sign assemblies use steel sign post, base post, anchor plate, retainer spacer strap, hardware and

appurtenances meeting Standard Road Detail Sheets R18.1 of the Miami-Dade County's Public Works Manual.

b. Sign Post:

- 1) Sign post must be provided with a galvanized 30 inch base post, retainer strap, galvanized anchor plate and all the miscellaneous hardware needed for installation as required by Standard Road Detail Sheets R18.1 of the Miami-Dade County's Public Works Manual.
- 2) Sign and base post must be rolled from rail steel meeting the properties established in ASTM A499. Minimum weight of each post prior to drilling must be three pounds per foot ( $\pm 5$  percent) with profile dimensions as specified in Standard Road Detail Sheets R18.1 of the Miami-Dade County's Public Works Manual. Post must be galvanized pursuant to ASTM A123 as the last step after fabrication and hole punching has been completed.
- 3) The galvanized steel post must be furnished in appropriate lengths to provide a minimum 7 ft. ground clearance to the bottom of the lowest sign unless otherwise shown in the Contract Documents or Standard Road Detail Sheets R18.1.
- 4) The finished post must be machine straightened and have a smooth uniform finish free from defects affecting strength, durability or appearance.
- 5) Bolt holes having a diameter of  $7 / 16$  of an inch must be punched at one inch centers along the post's center line beginning one inch from the top of the post and continued down the length of the post.

c. Anchor Plate:

- 1) Anchor plate must be 6 inch x 12 inch x 0.120 inch steel, hot dip galvanized per ASTM A123. The anchor plate must have two  $7 / 16$  inch diameter holes for attaching to base post with sign/base post assembly hardware.

d. Hardware:

- 1) Nuts, bolts, and washers for attaching signs must be 2024-T4 aluminum. Hex-head bolts must be  $5 / 16$  inch – 18 UNC x  $2 - 1 / 2$  inch with hexagon nuts and flat washers.
- 2) Hardware for attaching sign post to the base post and anchor plates must be Hex-head integral flange bolt, nut and lockwasher. Bolts must be  $5 / 16$  inch – UNC x  $1 - 3 / 4$  inch meeting ASTM A354, Grade BD (Grade 8). Nuts must be ASTM A563, Grade DH. Lock washer must be heavy duty external type. Finish must be cadmium plated per ASTM A165-80, Type OS, except using clear chromate.
- 3) Retainer-Spacer Strap must be AISI 1020 Steel and be  $17 1 / 8$  inch x one inch x  $0 - 3 / 8$  inch thick with a  $0 - 3 / 8$  inch offset, galvanized per ASTM A123.

F. Internally Illuminated Street Name Sign.

1. Use Internally Illuminated Street Name Sign and mounting hardware that meet the requirements of FDOT Specification Section 700 (Highway Signing) and this Specification.
2. Use Internally Illuminated Street Name Sign and mounting hardware that are listed on the FDOT's APL and the Department's TSSQPL.

G. Electronic Display Sign Assembly.

1. Meet the requirements of FDOT Specification Section 700 (Highway Signing) and this Specification.
2. Use Electronic Display Sign and mounting hardware that meet the requirements of this Specification and are listed on the FDOT's APL and the Department's TSSQPL.
3. Unless otherwise shown in the Plans and approved by Engineer, the ESFS, its components, and sign panels must be U-bolt mounted on a Miami-Dade County TSSQPL approved 4-1/2 inches outer diameter (4 inch nominal) threaded aluminum pedestal pole and square aluminum break away base with a reinforcing collar assembly meeting the requirements of FDOT Specification Section 646. Attachment hardware must meet or exceed the requirements of the Florida Department of Transportation (FDOT) Standard Plans, Index No. 700-010.

H. Sign Beacon Assembly:

1. Meet the requirements of FDOT Specification Section 700 (Highway Signing) and this Specification.
2. Use Sign Beacon assembly and mounting hardware that meet the requirements of this Specification and are listed on the FDOT's APL and the Department's TSSQPL.
  - a. Beacon assemblies intended for use with school zone signing must include a remote means approved by the Department for centralized remote calendar scheduling program days and times of operation.
  - b. Vehicle activated beacons must utilize a vehicle detection system listed on the FDOT APL and the TSSQPL.
  - c. Pedestrian activated beacons must utilize a pedestrian detector listed on the FDOT APL and the TSSQPL.
3. Unless otherwise shown in the Plans and approved by Engineer, the Beacon Assembly, its components, and sign panels must be U-bolt mounted on a Miami-Dade County TSSQPL approved 4-1/2 inches outer diameter (4 inch nominal) threaded aluminum pedestal pole and square aluminum break away base with a reinforcing collar assembly meeting the requirements of FDOT Specification Section 646. Attachment hardware must meet or exceed the requirements of the Florida Department of Transportation (FDOT) Standard Plans, Index No. 700-010.

## PART 3 EXECUTION

### 3.01 INSTALLATION

A. General.

1. Meet all requirements of FDOT Specification Section 620 (Grounding and Lightning Protection) and the National Electrical Code.
2. Perform and document utility clearances.

B. Roadway Static Sign Assembly (ground-mounted).

1. Install pursuant to Standard Road Detail Sheets R18.1 of the Miami-Dade County's Public Works Manual and the Contract Documents.

C. Internally Illuminated Street Name Sign.

1. Install pursuant to FDOT Specification Section 700, the Contract Documents, and the wiring, mounting and installation requirements of the Miami-Dade County TSS Division's "Typical Wiring and Installation Details Internally Illuminated Street Name Signs (IISNS)".
- D. Electronic Display Sign Assembly.
1. Install pursuant to FDOT Specification Section 700 and the Contract Documents.
  2. For ground mounted EDS Assembly.
    - a. Construct foundation and install support structure in accordance with FDOT Section 646, this Specification Section, Standard Plans, Index 700-120, and the Contract Documents.
    - b. Set anchor bolts 90 degrees apart with a bolt circle diameter of 13 inches. Adjust anchor bolts to a plumb line and hold rigidly in position to prevent displacement while pouring concrete.
    - c. Meet the requirements of FDOT Specification Section 620 and the NEC.
- E. Sign Beacon Assembly.
1. Install pursuant to FDOT Specification Section 700 and the Contract Documents.
  2. For ground mounted Sign Beacon Assembly.
    - a. Construct foundation and install support structure in accordance with FDOT Section 646, this Specification Section, Standard Plans, Index 700-120, and the Contract Documents. Bolt circle radius must be thirteen inches.
    - b. Set anchor bolts 90 degrees apart with a bolt circle diameter of 13 inches. Adjust anchor bolts to a plumb line and hold rigidly in position to prevent displacement while pouring concrete.
    - c. Meet the requirements of FDOT Specification Section 620 and the NEC.

### 3.02 REMOVAL

- A. Deliver sign panels, sign assemblies, EDS, IISNS and all sign equipment removed pursuant to these specifications a to the Department of Transportation and Public Works, Traffic Signals and Signs Division's Yard at 7100 NW 36th Street, Miami, FL 33166.
- B. Document delivery and coordinate with the TSS Division's warehouse manager prior to offloading the material.

### 3.03 RESTORATION

- A. Restore all areas impacted by the Work.
- B. Restore any areas impacted by the installation of a crosswalk enhancement assembly to original condition unless otherwise shown in the Plans. Install crosswalk enhancement assembly in accordance with the Americans with Disabilities Act Standards for Transportation Facilities.

END OF SECTION 700

APPENDIX "T" TO SPECIAL PROVISIONS

ROW Certification Form# 575-095-35

STATE OF FLORIDA DEPARTMENT OF TRANSPORTATION  
**LAP CERTIFICATION**

575-095-05  
RIGHT OF WAY  
01/17

R/W ITEM/SEGMENT NO.: VARIES MANAGING DISTRICT: 6  
CONSTRUCTION ITEM/SEGMENT NO.: \_\_\_\_\_ STATE ROAD: NOT APPLICABLE  
F.A.P. NO. (Construction): 439894-1 DESCRIPTION: SAFE ROUTE TO SCHOOL  
FLAGAMI ELE, CARRIE P. MEEK/WESTVIEW ELE,  
SHADOWLAWN ELE AND HUBERT O SIBLEY ELE  
SCHOOLS  
COUNTY: MIAMI-DADE  
LETTING DATE: NOT AVAILABLE

The undersigned hereby certifies as follows:

Title to all property and easements needed for the above construction project is vested in the Florida Department of Transportation (Department) or a state or local government. The Department has obtained sufficient authority to construct and maintain the proposed improvements on property and easements owned by state or local governments. Further:

**Acquisition**

- Right of way was not acquired for this project.
- Right of way was acquired for this project in compliance with applicable state and federal law.

**Relocation**

- No persons or businesses were required to move or move personal property from the project right of way.
- All persons and businesses that were required to move or move personal property from the project right of way have been provided relocation assistance in compliance with applicable state and federal law.

**Demolition**

- No structures or improvements, including encroachments, required removal from the project right of way.
- All structures and/or improvements, including encroachments, have been removed from the project right of way in compliance with applicable state and federal law, or will be included in the construction contract.

**Asbestos Abatement**

- No structures or improvements requiring asbestos abatement were located on the project right of way.
- Asbestos abatement of buildings and/or structures, including those to be removed by the construction contractor, has been completed in compliance with applicable state and federal law, or will be included in the construction contract.

Submitted by Local Agency:   
Title: Jon Orue Date: 10/03/2022

Certified by FDOT: \_\_\_\_\_  
Title: \_\_\_\_\_ Date: \_\_\_\_\_



APPENDIX "U" TO SPECIAL PROVISIONS ROW

Railroad Clear Letter



**Transportation and Public Works**

Traffic Engineering Division  
111 NW 1st Street • Suite 151 0  
Miami, Florida 33128  
T 305-375-2030 F 305-372-6064

DATE: 10/03/2022  
TO: FDOT/ Andre Goins  
FROM: Jon Orue  
CC: Yamilet Senespleda, P.E.  
SUBJECT: Railroad Certification  
*Miami Dade County Department of Transportation & Public  
Works FM #: 439894-1  
Description: Safe Route to Schools*

The referenced project DOES NOT have railroad involvement within the limits of the project.

The project consists of roadways improvements to selected schools in the County so students can walk safety to and from school.

You may consider this project to be railroad **CLEAR**.

Jon Orue

A handwritten signature in black ink, appearing to be "Jon Orue".

10/03/2022

---

Local Agency Project Manager

Date

APPENDIX "V" TO SPECIAL PROVISIONS

Utilities Clear Letter



**Transportation and Public Works**

Traffic Engineering Division  
111 NW 1st Street • Suite 151 0  
Miami, Florida 33128  
T 305-375-2030 F 305-372-6064

DATE: 10/03/2022

TO: FDOT/ Andre Goins

FROM: Jon Orue

CC: Yamilet Senespleda, P.E

SUBJECT: **Utilities Clear**  
*Miami Dade County Department of Transportation & Public Works FM #: 439894-1*  
*Description: Safe Route to Schools (SRTS)*

This is to certify that all utility work has been completed or necessary arrangements made to undertake and complete this project as required for proper coordination with the physical construction schedule.

Jon Orue  10/03/2022

---

Local Agency Project Manager Date

APPENDIX "W" TO SPECIAL PROVISIONS

No Permits Clear Letter



DATE: 10/03/2022  
TO: FDOT / Andree Goins  
FROM: Jon Orue  
CC: Yamilet Senespleda, P.E.  
SUBJECT: 100% Design Memo for Environmental Permits  
*Miami Dade County Department of Transportation and Public Works  
(DTPW) FM #: 439894-1  
Description: Safe Route to Schools (SRTS)*

No environmental permits are required for the referenced project as:

- 1. Drainage is not being changed.
- 2. No wetlands are being impacted.
- 3. There is no encroachment into the 100-year floodplain.
- 4. No additional travel lanes are proposed.

The following “no permit required determinations” were obtained:

If NPDES is required, is SWPPP included in plans? N/A

Jon Orue

10/03/2022

---

Local Agency Project Manager

Date

## **SECTION 8: ENGINEERING DRAWINGS**

ENGINEERING DRAWINGS ARE AVAILABLE SEPARATE FROM THIS  
PORTION OF THE SOLICITATION DOCUMENTS.