



DEPARTMENT OF REGULATORY AND ECONOMIC RESOURCES (RER)
BOARD AND CODE ADMINISTRATION DIVISION

MIAMI-DADE COUNTY
PRODUCT CONTROL SECTION
11805 SW 26 Street, Room 208
Miami, Florida 33175-2474
T (786) 315-2590 F (786) 315-2599
www.miamidade.gov/economy

NOTICE OF ACCEPTANCE (NOA)

IKO Industries Inc.
6 Denny Road, Suite 200
Wilmington, Delaware 19809

SCOPE:

This NOA is being issued under the applicable rules and regulations governing the use of construction materials. The documentation submitted has been reviewed and accepted by Miami-Dade County RER - Product Control Section to be used in Miami-Dade County and other areas where allowed by the Authority Having Jurisdiction (AHJ).

This NOA shall not be valid after the expiration date stated below. The Miami-Dade County Product Control Section (in Miami-Dade County) and/or the AHJ (in areas other than Miami-Dade County) reserve the right to have this product or material tested for quality assurance purposes. If this product or material fails to perform in the accepted manner, the manufacturer will incur the expense of such testing and the AHJ may immediately revoke, modify, or suspend the use of such product or material within their jurisdiction. RER reserves the right to revoke this acceptance, if it is determined by Miami-Dade County Product Control Section that this product or material fails to meet the requirements of the applicable building code.

This product is approved as described herein, and has been designed to comply with the Florida Building Code including the High Velocity Hurricane Zone of the Florida Building Code.

DESCRIPTION: IKO Laminate Shingles

LABELING: Each unit shall bear a permanent label with the manufacturer's name or logo, city, state and following statement: "Miami-Dade County Product Control Approved", unless otherwise noted herein.

RENEWAL of this NOA shall be considered after a renewal application has been filed and there has been no change in the applicable building code negatively affecting the performance of this product.

TERMINATION of this NOA will occur after the expiration date or if there has been a revision or change in the materials, use, and/or manufacture of the product or process. Misuse of this NOA as an endorsement of any product, for sales, advertising or any other purposes shall automatically terminate this NOA. Failure to comply with any section of this NOA shall be cause for termination and removal of NOA.

ADVERTISEMENT: The NOA number preceded by the words Miami-Dade County, Florida, and followed by the expiration date may be displayed in advertising literature. If any portion of the NOA is displayed, then it shall be done in its entirety.

INSPECTION: A copy of this entire NOA shall be provided to the user by the manufacturer or its distributors and shall be available for inspection at the job site at the request of the Building Official.

This NOA renews NOA# 23-0417.02 and consists of pages 1 through 8.
The submitted documentation was reviewed by Rafael Macedo.

04/16/26



NOA No.: 25-1202.02
Expiration Date: 04/21/31
Approval Date: 04/16/26
Page 1 of 8

ROOFING ASSEMBLY APPROVAL

Category:	Roofing
Sub-Category:	Asphalt Shingles
Materials:	Laminate
Deck Type:	Wood

SCOPE

This approves a roofing system using **Dynasty, Cambridge, Armourshake, Nordic, Crowne Slate, and Royal Estate** asphalt shingles manufactured by IKO Industries Inc. as described in Section 2 of his Notice of Acceptance, designed to comply with the High Velocity Hurricane Zone of the Florida Building Code.

PRODUCT DESCRIPTION

<u>Product</u>	<u>Dimensions</u>	<u>Test Specifications</u>	<u>Product Description</u>
Dynasty <i>Manufacturing Location #1, 2, 4</i>	13 3/4" x 40 7/8"	ASTM D 3462	A heavy weight, fiberglass reinforced laminate asphalt shingle.
Cambridge <i>Manufacturing Location #1, 2, 4</i>	13 3/4" x 40 7/8"	ASTM D 3462	A heavy weight, fiberglass reinforced laminate asphalt shingle.
Armourshake <i>Manufacturing Location #3</i>	18 1/2" x 37 3/8"	ASTM D 3462	A heavy weight, fiberglass reinforced laminate asphalt shingle.
Nordic <i>Manufacturing Location #1, 4, 6</i>	13 3/4" x 40 7/8"	ASTM D 3462	A heavy weight, fiberglass reinforced laminate asphalt shingle.
Crowne Slate <i>Manufacturing Location #5</i>	13 1/4" x 39 1/2"	ASTM D 3462	A heavy weight, fiberglass reinforced laminate asphalt shingle.
Royal Estate <i>Manufacturing Location #5</i>	13 1/4" x 40"	ASTM D 3462	A heavy weight, fiberglass reinforced laminate asphalt shingle.

MANUFACTURING LOCATION

1. Kankakee, IL.
2. Sylacauga, AL.
3. Sumas, WA.
4. Hillsboro, TX.
5. Toronto, ON.
6. Calgary, AB



NOA No.: 25-1202.02
Expiration Date: 04/21/31
Approval Date: 04/16/26
Page 2 of 8

EVIDENCE SUBMITTED

<u>Test Agency</u>	<u>Test Identifier</u>	<u>Test Name/Report</u>	<u>Date</u>
PRI Construction Materials Technologies, LLC	IKO-203-02-07	TAS 100	09/29/17
	IKO-203-02-01	ASTM D3462 & E108	12/05/17
	IKO-203-02-02	ASTM D3161	01/09/18
	IKO-201-02-07	TAS 100	09/05/18
	IKO-201-02-01	ASTM D3462 & E108	09/07/18
	IKO-201-02-02	ASTM D3161	09/05/18
	IKO-076-02-01	TAS 100	03/02/12
	IKO-476C0001.1	ASTM D3462	05/12/20
	IKO-476C0001.2	ASTM D3161	05/12/20
	IKO-476C0001.3	ASTM E108	05/13/20
	IKO-114-02-01	TAS 100	09/24/17
	IKO-476C0028.1	ASTM D3462	06/03/20
	IKO-476C0028.2	ASTM D3161	06/03/20
	IKO-476C0028.3	ASTM E108	06/03/20
	IKO-053-02-01.1	TAS 100	01/21/11
	IKO-476T0005	ASTM D3462 & E108	05/04/20
	IKO-476T0006	ASTM D3161	05/04/20
	476C0017.1	ASTM D 3462	03/27/20
	476C0017.2	ASTM D 3161	03/27/20
	476C0017.3	ASTM E 108	03/27/20
	476T0127	TAS 100	09/01/21
	476T0121	ASTM D 3462	10/04/21
	476T0123	ASTM D 3161	10/04/21
	476T0122	ASTM E 108	10/04/21
	476T0126	TAS 100	09/01/21
	476C0015	ASTM D 3462	02/03/22
	476C0015	ASTM D 3161	02/03/22
	476C0015	ASTM E 108	02/02/22
	476T0141	TAS 100	12/16/21
	476T0147	ASTM D 3462	03/02/22
	IKO-202-02-02	ASTM D 3161	3/02/22
	476C0004	ASTM E 108	03/02/22
	476T0138	TAS 100	12/06/21
	476C0020	ASTM D 3462	02/03/22
	476C0020	ASTM D 3161	02/03/22
	476T0020	ASTM E 108	02/03/22
	476T0136	TAS 100	12/06/21
	476C0021, 476C0055, 476C0078, 476C0109, 476C0138	ASTM D 3462	07/11/22
476C0021, 476C0055, 476C0109	ASTM D 3161	07/11/22	
476C0021, 476C0055, 476C0078, 476C0109, 476C0138	ASTM E 108	08/03/24	
476T0169	TAS 100	06/30/22	
476T0264	ASTM D 3462	12/04/23	
476T0265	TAS 107/ASTM D 3161	11/30/23	
476T0237	TAS 100	06/01/23	
476T0192	ASTM D 3462	12/14/22	



476T0193	ASTM D 3462	08/03/23
476T0201	ASTM E 108	08/03/23
476T0196	TAS 107/ASTM D 3161	10/03/22
476T0197	ASTM E 108	12/14/22
476T0202	TAS 100	12/14/22

LIMITATIONS

1. Fire classification is not part of this acceptance; refer to a current Approved Roofing Materials Directory for fire ratings of this product.
2. Shall not be installed on roof mean heights in excess of 33 ft.
3. All products listed herein shall have a quality assurance audit in accordance with the Florida Building Code and Rule 61G20-3 of the Florida Administrative Code.

INSTALLATION

1. Shingles shall be installed in compliance with Roofing Application Standard RAS 115.
2. Flashing shall be in accordance with Roofing Application Standard RAS 115
3. The manufacturer shall provide clearly written application instructions.
4. Exposure and course layout shall be in compliance with Detail 'A', attached.
5. Nailing shall be in compliance with Detail 'B', attached.

LABELING

1. Shingles shall be labeled with the Miami-Dade Seal as seen below, or the wording “Miami-Dade County Product Control Approved”.



BUILDING PERMIT REQUIREMENTS

1. Application for building permit shall be accompanied by copies of the following:
 - 1.1 This Notice of Acceptance.
 - 1.2 Any other documents required by the Building Official or the applicable code in order to properly evaluate the installation of this system.



DETAIL A

NORDIC, DYNASTY, CAMBRIDGE COURSE LAYOUT

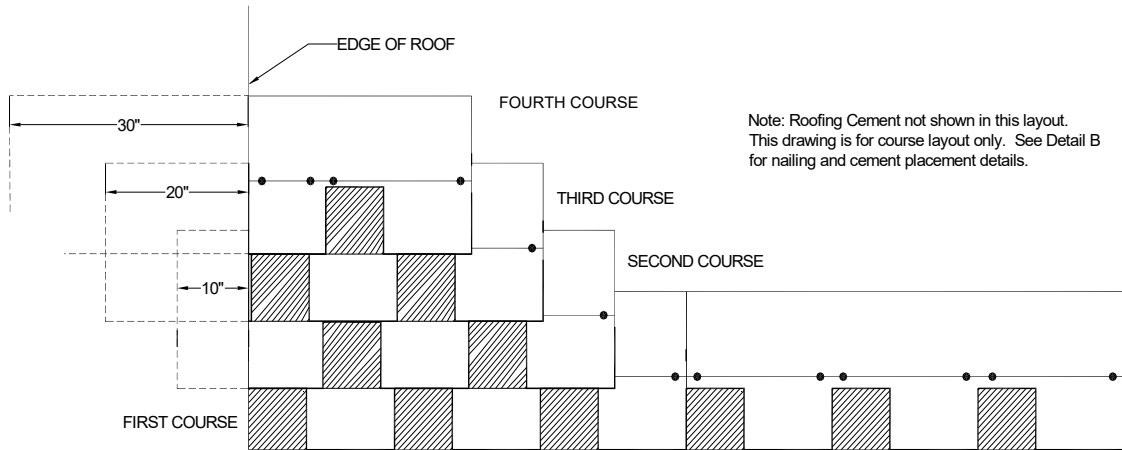

ARMOURSHAKE COURSE LAYOUT

NOTE:

- 1ST COURSE - FULL SHINGLE,
- 2ND COURSE - REMOVE 5-5/8"
- 3RD COURSE - REMOVE 11-1/4"
- 4TH COURSE - REMOVE 16-7/8"
- 5TH COURSE - REMOVE 22-1/2"
- 6TH COURSE - REMOVE 28-1/8"
- 7TH COURSE - FULL SHINGLE

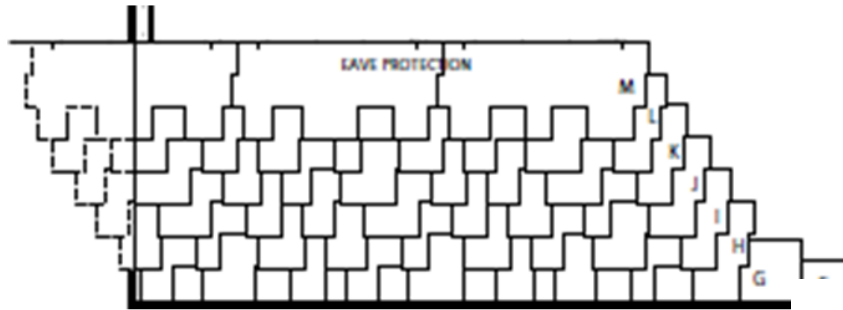

CROWNE SLATE COURSE LAYOUT

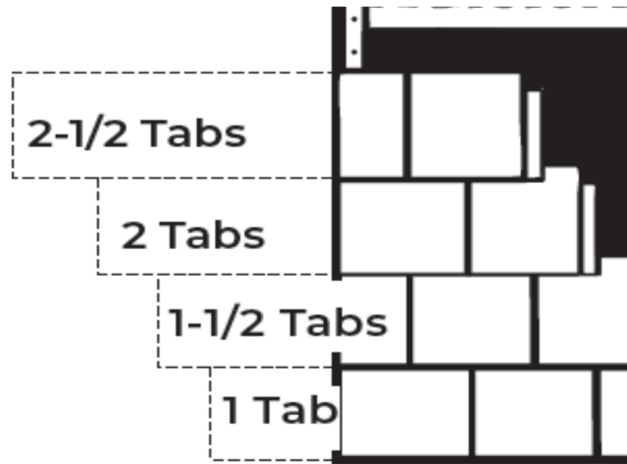

ROYAL ESTATE COURSE LAYOUT

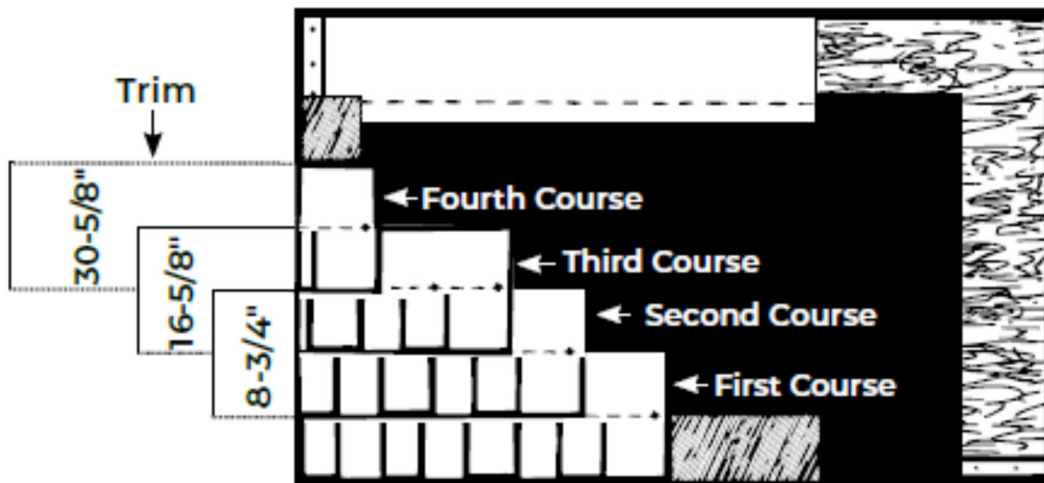

DETAIL B
NORDIC, DYNASTY, CAMBRIDGE NAILING PATTERN

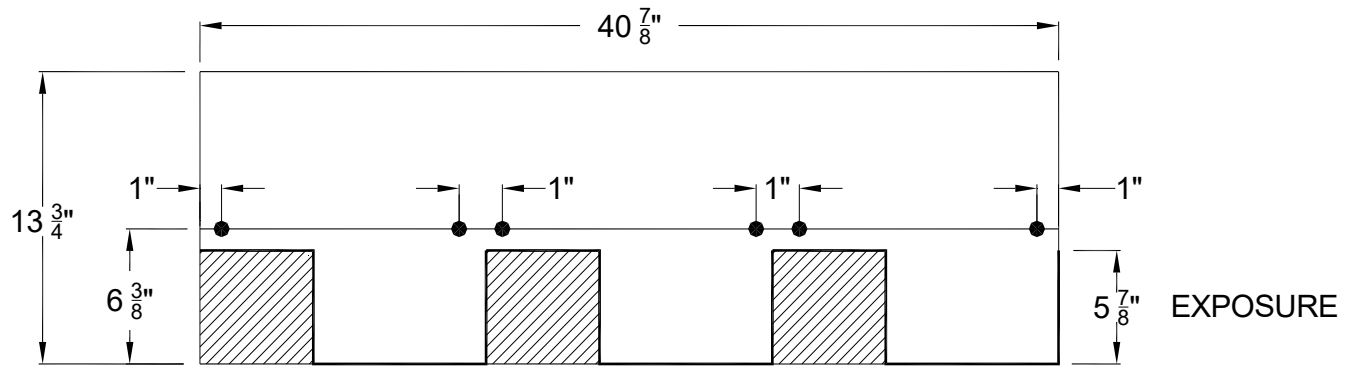

ARMOURSHAKE NAILING PATTERN

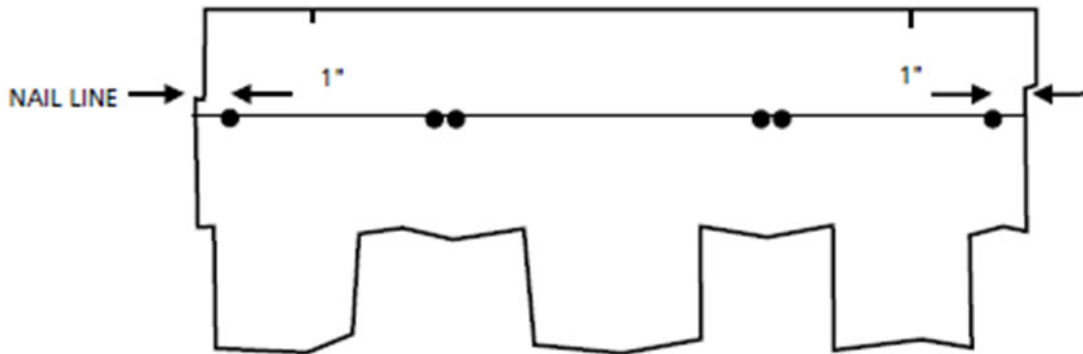

NOTE: USE BUILT IN NOTCH TO DETERMINE PROPER EXPOSURE. NAILS SHALL PENETRATE THE SHINGLE UNDERNEATH.

CROWNE SLATE NAILING PATTERN

Requires **8 Nails**

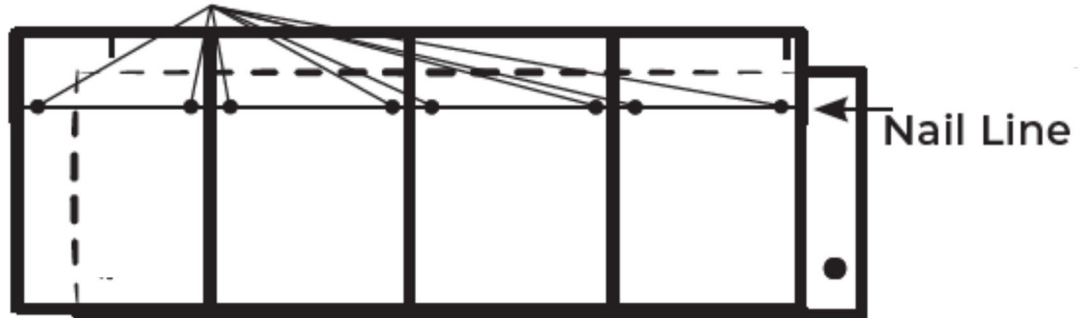

ROYAL ESTATE NAILING PATTERN

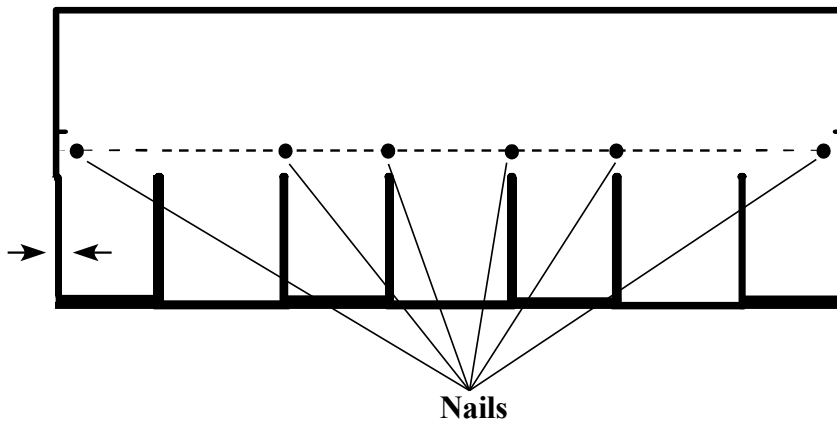

END OF THIS ACCEPTANCE