



## MEMORANDUM

Agenda Item 15(B)4

---

TO: Honorable Chairman Esteban L. Bovo, Jr. and DATE: June 5, 2018  
Members, Board of County Commissioners

FROM: Honorable Harvey Ruvin, Clerk  
Circuit and County Courts

SUBJECT: Proposed Boundary Change  
to the City of Coral Gables  
High Pines/Ponce Davis

Christopher Agrippa, Director  
Clerk of the Board Division

---

Pursuant to the provisions of Chapter 20-5 of the Code of Miami-Dade County, the Clerk of the Board has received a petition from the City of Coral Gables requesting a boundary change to an unincorporated area of the City's western boundary known as High Pines/Ponce Davis area.

Following consideration by the County Commission, the Code provides that this request be forwarded to the Planning Advisory Board for review, study and recommendation.

CA/sm

Attachment

CLERK OF THE BOARD

2018 APR 30 AM 10:15

MIAMI-DADE COUNTY, FLA.  
#1

**City of Coral Gables**

**High Pines / Ponce Davis Annexation Application**

Submittal to: Miami-Dade County

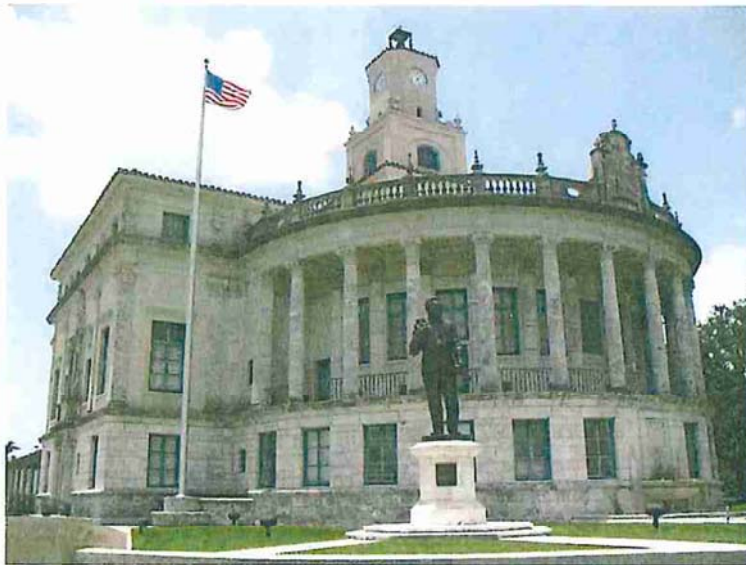

Prepared By: City of Coral Gables

&

**ILER** PLANNING

April 27, 2018

**Table of Contents**

Introduction..... 1

I. Area Description..... 3

II. Land Use and Zoning..... 6

III. Grounds for the Proposed Boundary Change ..... 12

IV. Service Provision..... 18

V. Timetable for Supplying Services..... 22

VI. Financing of Services ..... 23

VII. Tax Load ..... 25

VIII. Conclusion..... 27

**Exhibits**

- A: Coral Gables City Commission Resolution No. 2018 - 105
- B: Legal Description of the High Pines / Ponce Davis Area
- C: Certificate of Publication of Public Hearing Notice
- D: Affidavit Certifying Mailing of Public Hearing Notice to Affected Property Owners
- E: Certificate of County Supervisor of Registration
- F: Applicable City Future Land Use Designations
- G: Applicable City Zoning District Regulations

## Introduction

On March 27, 2018, the Coral Gables City Commission adopted Resolution No. 2018 -105 (see Exhibit A) approving the submittal of an application to Miami-Dade County for the annexation of a 675-acre unincorporated area on the City's western boundary known as High Pines / Ponce Davis and depicted in Figure 1. Exhibit B contains a boundary description for the High Pines / Ponce Davis area.

Since April 2017, two (2) community meetings regarding annexation have been held in this area. A local community group sponsored a well-attended meeting on May 2, 2017, at the Audubon House in which the City made a presentation and answered questions. Following that, on June 6, 2017, the City sponsored a community meeting at the Riviera Presbyterian Church attended by 197 people. In December 2017 and January 2018, staff sent out survey and petition mailings to all registered voters (2,382) in the High Pines / Ponce Davis area. To date, 27.2% of the registered voters in the area have sent in signed petitions supporting the annexation. For the entire area, 60% of responding registered voters support annexation while 40% are against it.

Resolution No. 2018-105 was adopted at an advertised public hearing in accordance with the County Code. The hearing notice was published in the Miami Herald, as well as several other public notice venues including the City's website (see Exhibit C). In addition, all property owners in High Pines / Ponce Davis and within 600 feet outside of its boundary were notified via direct mailing of the March 27, 2018 City Commission meeting. An affidavit certifying the mailing is provided in Exhibit D.

The Supervisor of Elections has reported that the High Pines / Ponce Davis area has 2,387 registered voters and thus, under the County Code, the City is required to submit valid support petitions from a minimum of 20% of those area electors. To meet this percentage, a minimum of 478 support petitions are required. Coral Gables has gathered a total of 663 signed support petitions from area voters (28%). These petitions will be delivered to the Clerk of the Board of County Commissioners under separate cover concurrent with the submittal of this application.

The subsequent sections of this application provide the additional information required by Section 20-3 of the Miami-Dade County Code.

Figure 1: High Pines / Ponce Davis Annexation Area

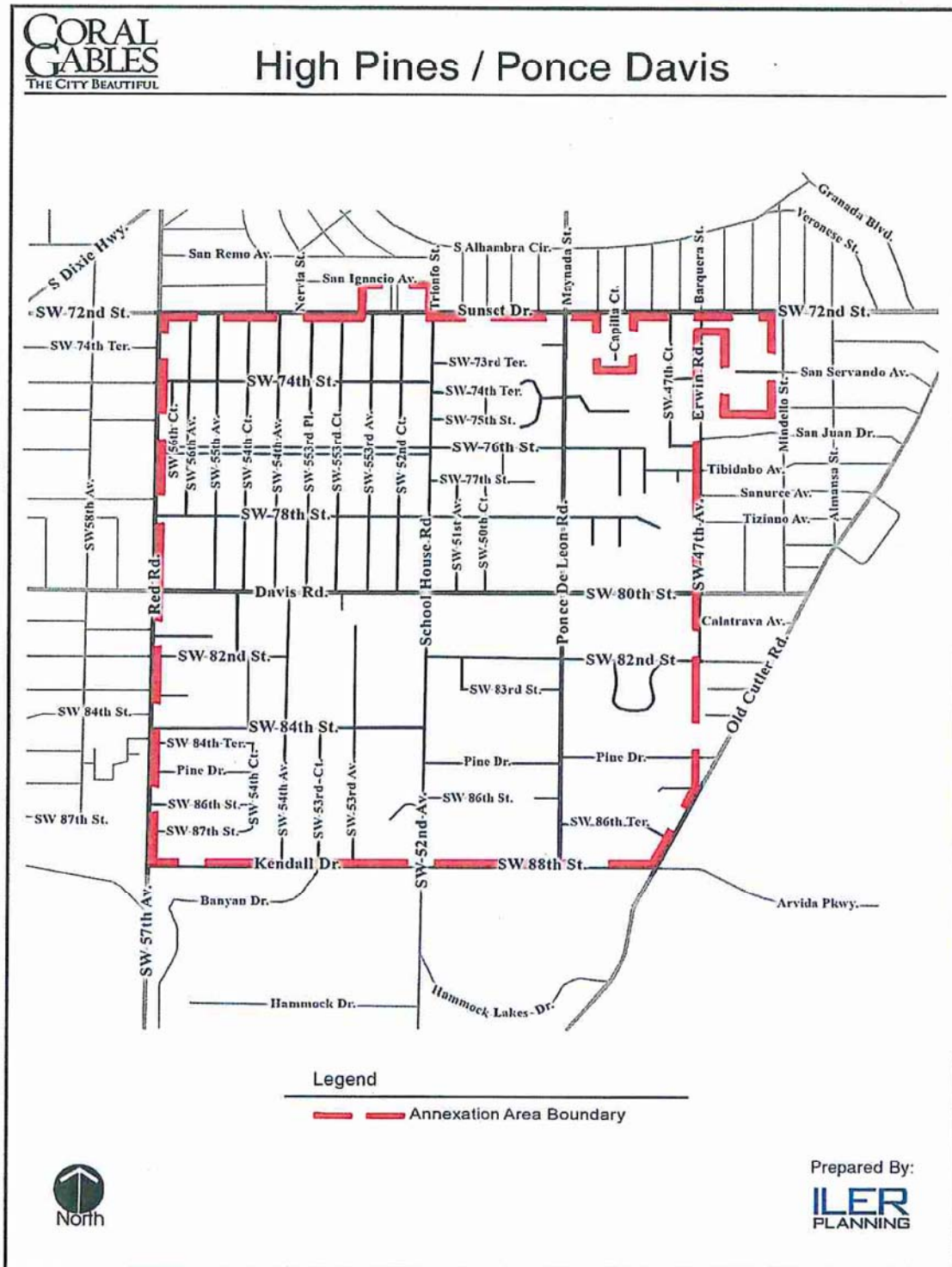

## I. Area Description

Figure 2 provides an aerial view of the High Pines / Ponce Davis area. It encompasses 675 acres and is situated southeast of the intersection of SW 72<sup>nd</sup> Street (Sunset Drive) and SW 57<sup>th</sup> Avenue (Red Road). The population is estimated to be 2,960 with 31% being Hispanic and 65% white (non-Hispanic) persons. The County Elections Department has recently determined there are 2,382 voters. The average household income is \$158,367 and 78% of the housing units are owner-occupied. The land use pattern in High Pines / Ponce Davis is decidedly single-family residential comprising 95% of the neighborhood. There are also 28 acres of multi-family residential and five (5) acres of commercial property. This neighborhood has 20.5 miles of paved roads.

The area is currently served by the Miami-Dade Police Department from its Kendal District Station located at 7707 SW 117<sup>th</sup> Avenue, an estimated seven (7) miles from the neighborhood. High Pines / Ponce Davis is also in the City Police Department's Zone 9 and, via a mutual aid agreement with Miami-Dade County Police, City officers frequently respond to calls in this neighborhood. With annexation, public safety responsibility for this neighborhood would be transferred to the Coral Gables Police Department. The property owners in the southeast portion of this area, generally located south of Davis Road (SW 80<sup>th</sup> Street) and east of SW 52<sup>nd</sup> Avenue, are part of the "Ponce Davis Roving Patrol District" which provides enhanced public safety and security at an annual cost of \$1,691 per year per property.

Fire and emergency medical services are provided by the Miami- Dade County Fire Department from the closest station at 5860 SW 70<sup>th</sup> Street, approximately 1.5 miles away. Coral Gables Station #2 is located at 525 South Dixie Highway, two (2) miles from the neighborhood, with two (2) fire engines, one (1) ladder truck and one (1) rescue truck. The City is planning a new fire station (Station #4) to be located in the vicinity of SW 57<sup>th</sup> Avenue and SW 72<sup>nd</sup> Street, very near the High Pines / Ponce Davis area. If annexation occurs, Fire and EMS services for High Pines / Ponce Davis would be transferred to the Coral Gables Fire Department.



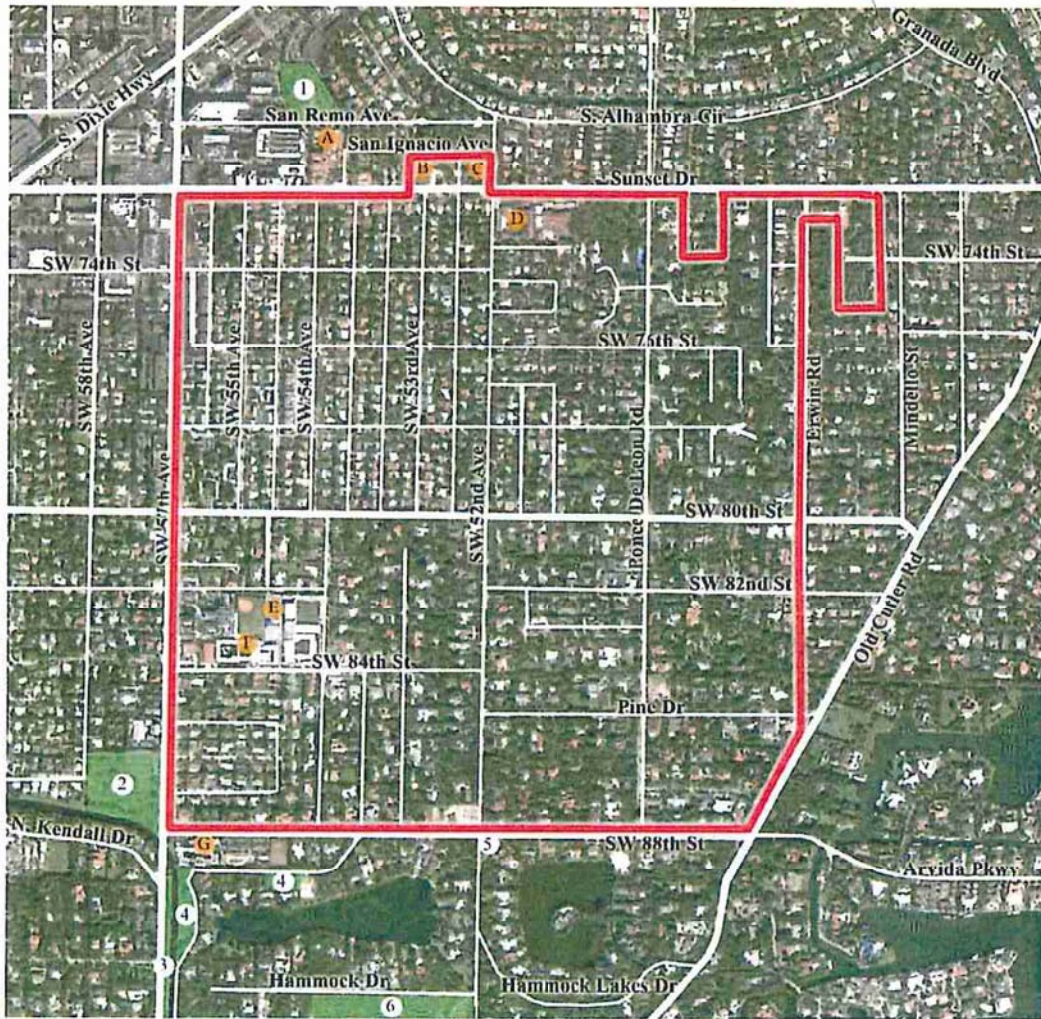

With regard to park and recreation services, the SW 76<sup>th</sup> Street median contains a fitness trail and small open spaces that could be acquired. Riviera Park, Pinewood Cemetery and South Miami's Dante Fascell Park serve a portion of the area as neighborhood parks and open spaces. The area is within the service radius for larger park systems due to the proximity of Matheson Hammock Park. Recreational programming is offered by Coral Gables at William H. Kerdyk Park, Family Park and Jaycee Park and Miami-Dade County provides programming at Chapman Field Park.

Figure 2: Aerial View of High Pines / Ponce Davis Area

## High Pines / Ponce Davis



**Legend**

- |   |  |
|---|--|
|  <ul style="list-style-type: none"> <li> Parks</li> <li>1. Riviera Park</li> <li>2. Dante Fascell Park (City of South Miami)</li> <li>3. Red Road Linear Park</li> <li>4. Banyan Drive Park</li> <li>5. Hammock Lake Park</li> <li>6. Matheson Hammock County Park</li> </ul> | <ul style="list-style-type: none"> <li> Schools</li> <li>A. Riviera Day School</li> <li>B. Child Care Center Inc</li> <li>C. Bilingual Cooperative Preschool</li> <li>D. Sunset Elementary School</li> <li>E. Our Lady of Lords Academy</li> <li>F. Epiphany School</li> <li>G. St. Thomas Episcopal Parish School</li> </ul> |
|  High Pines / Ponce - Davis Neighborhood   |  |

Prepared By:  
**ILER**  
PLANNING

The High Pines / Ponce Davis area has a number of educational facilities as listed below and shown in Figure 2.

- \* Riviera Day School
- \* Child Care Center Inc.
- \* Bilingual Cooperative Preschool
- \* Sunset Elementary School
- \* Our Lady of Lourdes Academy
- \* Epiphany Catholic School
- \* St. Thomas Episcopal Parish School.



## II. Land Use and Zoning

### Land Use

High Pines / Ponce Davis is essentially built-out except for a few scattered vacant parcels. Land use in the annexation area is under the jurisdiction of Miami-Dade County and its adopted Comprehensive Development Master Plan (CDMP). Figure 3 shows the existing future land use pattern in the area according to the County's adopted 2020 and 2030 Land Use Plan. The current County future land use designations applied in High Pines / Ponce Davis are listed below.

- Estate Density Residential (1 - 2.5 dwelling units per acre)
- Low Density Residential (2.5 – 6 dwelling units per acre)
- Low-Medium Density Residential (6-13 dwelling units per acre)
- Business and Office
- Office / Residential

The specific standards and requirements for each of the above future land use designations are contained in the Future Land Use Element of the Miami-Dade County CDMP. The future land use allocation for the High Pines / Ponce Davis area is approximately 64% Estate Density Residential use, 27% Low Density Residential use, 5% Low-Medium Density Residential use and with the remaining 4% in commercial use categories. If the annexation is approved, the City will apply similar future land use categories to those shown on the adopted County Land Use Plan to the extent possible for the High Pines / Ponce Davis area. Figure 4 shows the proposed City future land use pattern and the specific designations are listed below:

- Single Family (0-6 dwelling units per acre)
- Multi-Family Low Density (20-25 dwelling units per acre)
- Commercial Low-Rise Intensity
- Education
- Religious / Institutional

Exhibit F contains the specific standards and requirements for each of the above City future land use designations from the Future Land Use Element of the Coral Gables Comprehensive Plan. Existing property rights are preserved under the City's plan to the maximum extent possible and, in some instances, City land use regulations may be less restrictive than County regulations.

Figure 3: County Land Use Designations

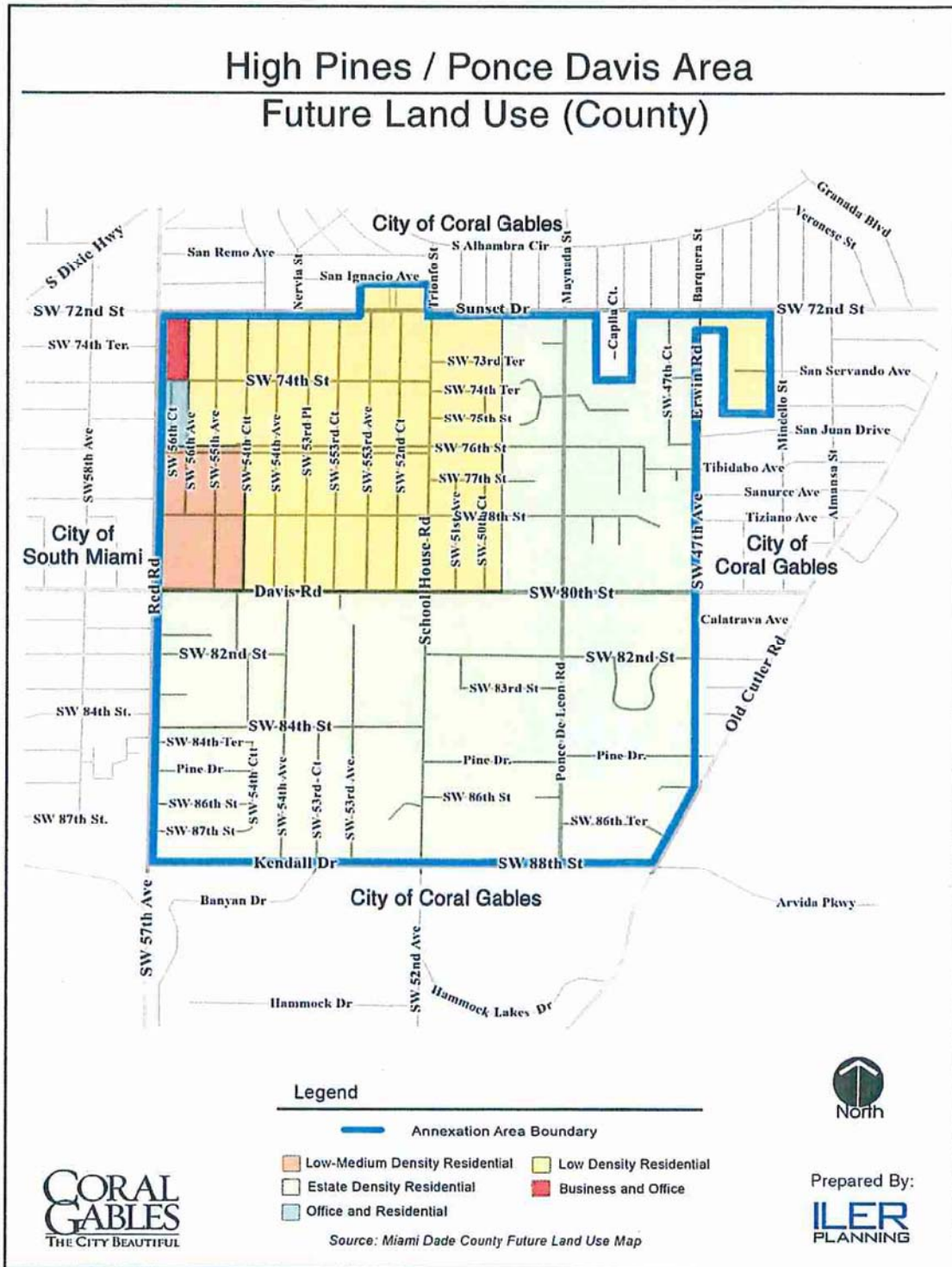
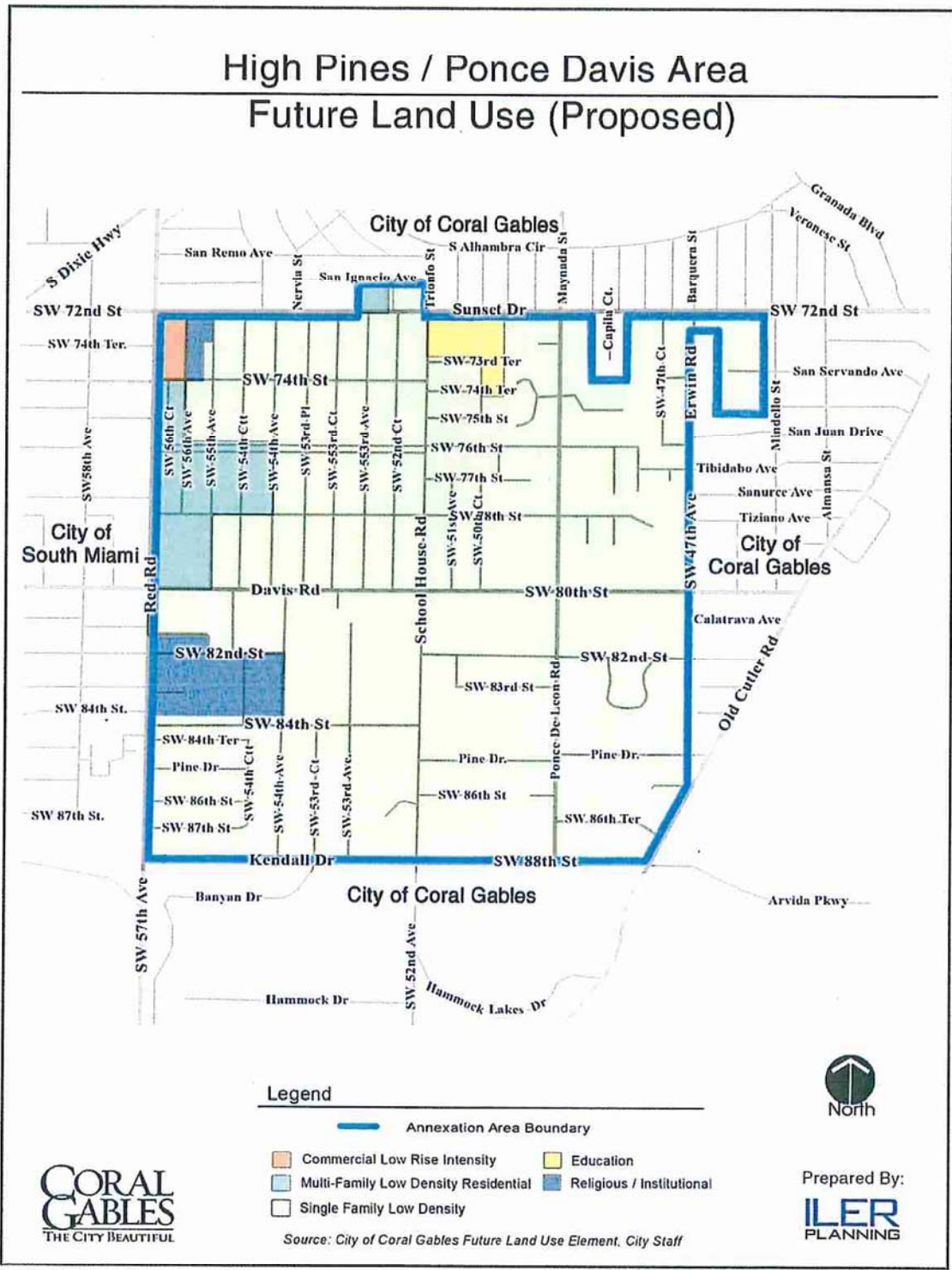

Figure 4: Proposed City Future Land Use Designations



## Zoning

Figure 5 depicts the ten (10) existing zoning districts applied in High Pines / Ponce Davis from the County's current Zoning Map. The existing zoning in the area is a mix of the zoning districts listed below:

- GU Interim Use
- EU-S Estate Use Suburban
- EU-M Estate Use Modified
- EU-1 Single-Family One Acre Estate
- RU-1 Single Family Residential
- RU-3 Four Unit Apartment House
- RU-3M High Density Apartment House
- BU-1 Neighborhood Business
- BU-1A Limited Business
- BU-2 Special Business

The regulations applicable to each of the zoning districts above are contained in the Miami-Dade County Code, Chapter 33. The proposed High Pines / Ponce Davis zoning pattern is presented in Figure 6, consisting of the four (4) districts listed below.

- SFR Single-Family Residential
- MFSA Multi-Family Special Area
- C Commercial
- S Special Use

Exhibit G contains the specific standards and requirements for the City zoning districts listed above. The transition of High Pines / Ponce Davis zoning from the Miami-Dade County Code to the Coral Gables zoning code has been a serious topic of discussion at community meetings. The City intends to apply, in due course, its zoning districts, as generally proposed in Figure 6, to those shown on the County zoning map for the area (Figure 5). In some instances, City zoning regulations may be less restrictive than County regulations. The City will make its best effort to provide for existing uses in High Pines / Ponce Davis that are lawful under the County Code. However, certain uses and structures may be considered nonconforming under the City's zoning code, which may need to come into compliance under certain circumstances such as redevelopment. Illegal uses under the County Code (i.e. those uses and structures established without proper zoning or permits) will not be legal in Coral Gables. Both Miami-Dade County and Coral Gables are governed by the same Florida Building Code, so there will be no change in the building code requirements for building renovations and new construction with annexation.

Figure 5: County Zoning Districts

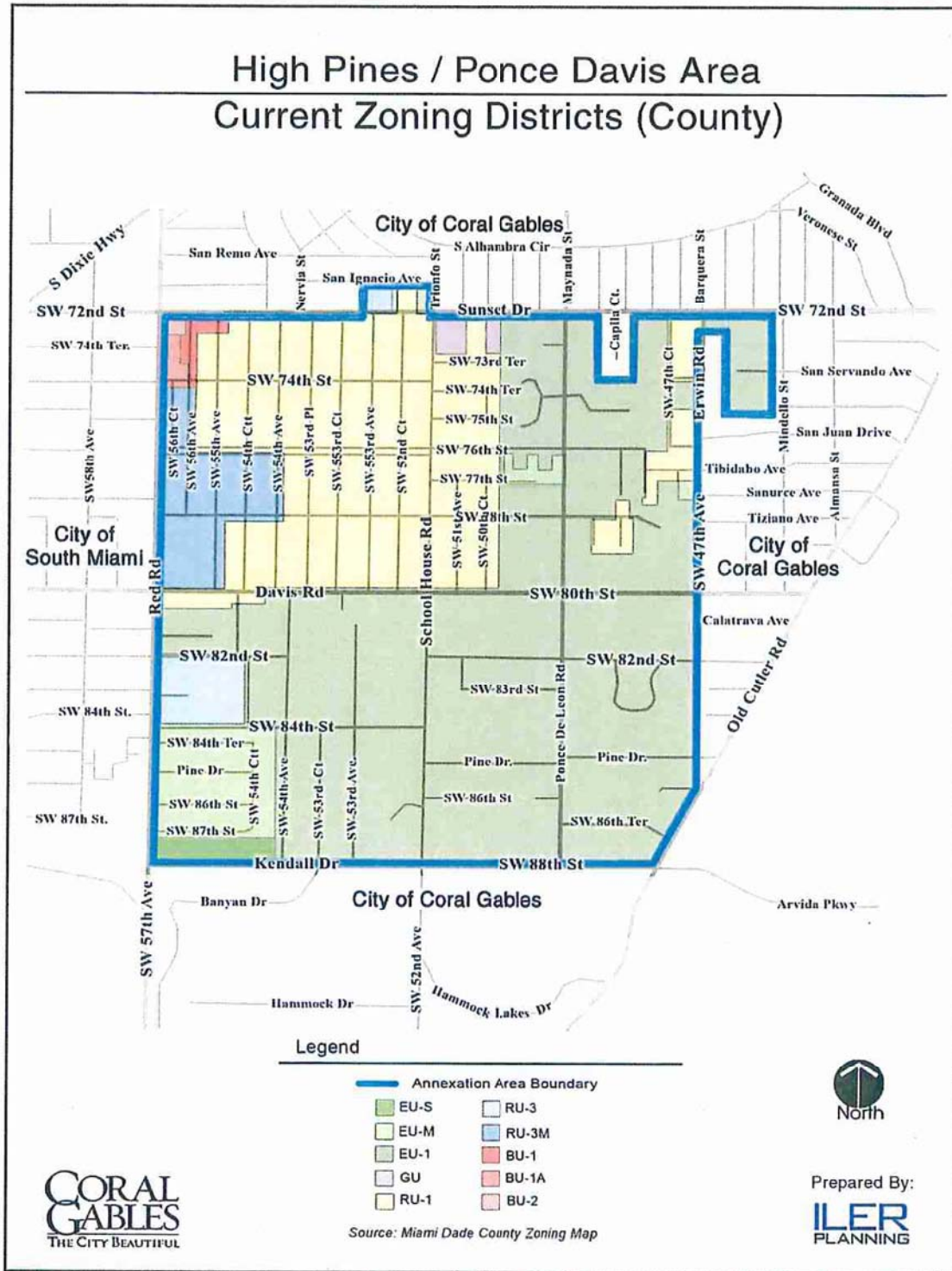
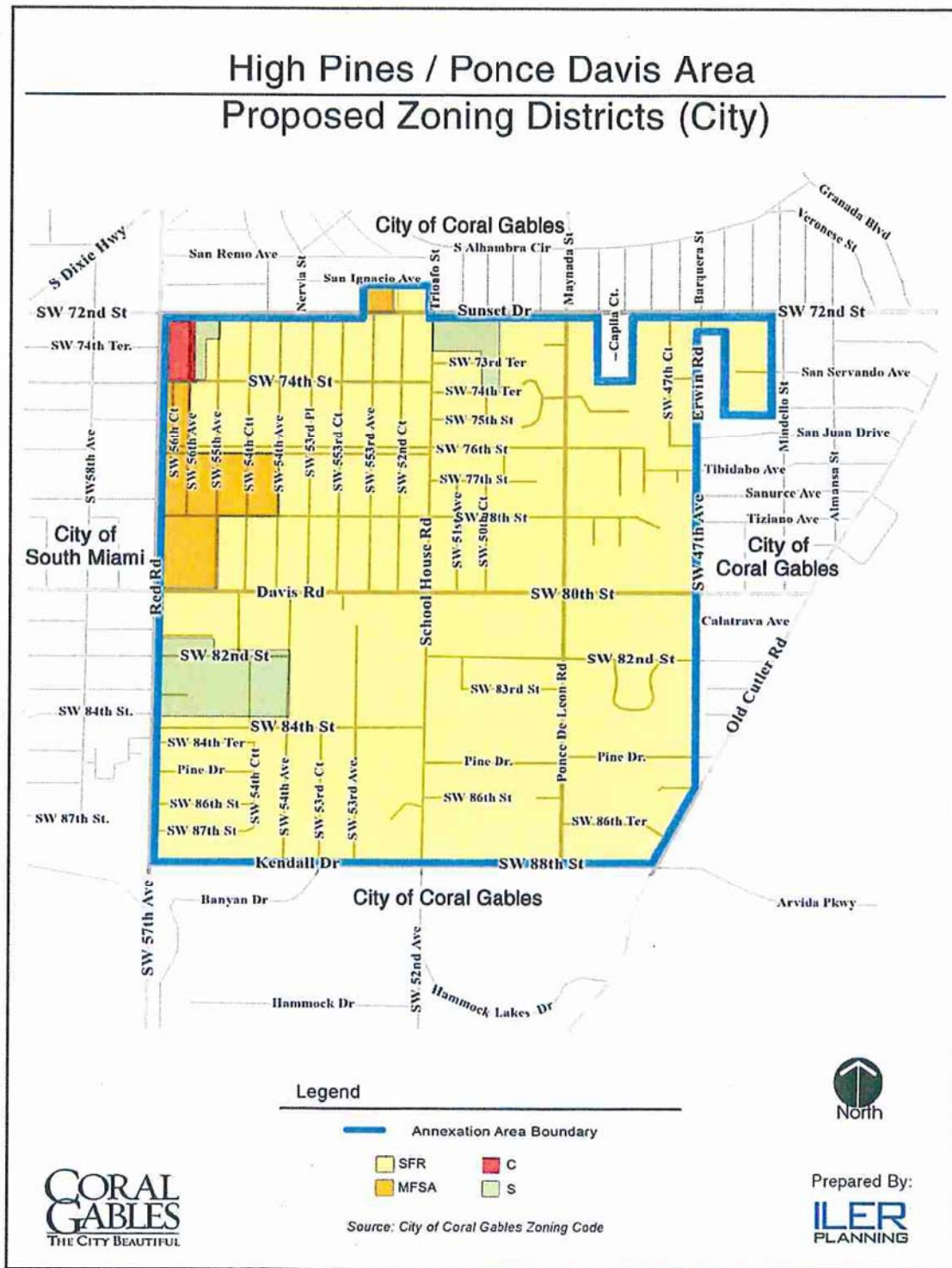

Figure 6: Proposed City Zoning Districts



### **III. Grounds for the Proposed Boundary Change**

There are a number of valid grounds supporting the annexation of High Pines / Ponce Davis into the boundaries of the City of Coral Gables as discussed below.

#### **Enclave Elimination**

High Pines / Ponce Davis is a complete enclave with respect to County jurisdiction, surrounded on three (3) sides by the City of Coral Gables and on the 4<sup>th</sup> side to the west across SW 57<sup>th</sup> Avenue (Red Road) by the City of South Miami. The annexation of High Pines / Ponce Davis into the City of Coral Gables will eliminate the existing County enclave in this area.

#### **Cost-Effective, Accessible and Enhanced Governmental Services**

Given the enclave status of High Pines / Ponce Davis and close proximity of Coral Gables' existing governmental facilities to the residents and property owners of area, the City can provide enhanced public services in a more cost-effective and efficient manner than Miami-Dade County. The primary services involved would be police, fire and emergency medical, parks and recreation, general government, planning and zoning, permitting, stormwater management, and local road maintenance including right-of-way landscape maintenance.

The area is currently served by the Miami-Dade Police Department from its Kendal District Station located at 7707 SW 117<sup>th</sup> Avenue, an estimated seven (7) miles from the neighborhood. High Pines / Ponce Davis is also in the City Police Department's Zone 9 and, via a mutual aid agreement with Miami-Dade County Police, City officers frequently respond to calls in this neighborhood. Based on information obtained from County staff, the Miami-Dade County Police response to this area averages 10 minutes for emergency calls and 34 minutes for non-emergencies. With annexation, public safety responsibility for this neighborhood would be transferred to the Coral Gables Police Department. Over the past 3.5 years, the average City Police response time to calls in and around High Pines / Ponce Davis has been five (5) minutes; non-emergency call response has averaged eight (8) minutes. The property owners in the southeast portion of this area, generally located south of Davis Road (SW 80<sup>th</sup> Street) and east of SW 52<sup>nd</sup> Avenue, are part of the "Ponce Davis Roving Patrol District" which provides enhanced public safety and security at an annual cost of \$1,691 per year per property. Thus, the City can provide this area with significantly faster and more accessible police services.

Currently, the High Pines / Ponce Davis neighborhood is part of the County Fire Service District. Fire and emergency medical services are provided by the Miami- Dade County Fire Department from the closest

station at 5860 SW 70<sup>th</sup> Street, approximately 1.5 miles away. The average County fire response to the area is seven (7) minutes. If annexation occurs, it is proposed that fire and emergency medical services for High Pines / Ponce Davis would be transferred to the Coral Gables Fire Department. Coral Gables Station #2 is located at 525 South Dixie Highway, two (2) miles from the neighborhood, with two (2) fire engines, one (1) ladder truck and one (1) rescue truck. The City is planning a new fire station (Station #4) to be located in the vicinity of SW 57<sup>th</sup> Avenue and SW 72<sup>nd</sup> Street, very near the High Pines / Ponce Davis area. The average City fire and emergency medical response time is six (6) minutes. City response to High Pines / Ponce Davis will be even faster given the City's plan to install a new station closer to High Pines / Ponce Davis. These figures show Coral Gables can provide faster and more accessible fire and emergency medical services to High Pines / Ponce Davis.

The City offers very good park and recreation services near High Pines / Ponce Davis today and plans to expand into the area with annexation. The SW 76<sup>th</sup> Street median contains a fitness trail and small open spaces that can be improved. This median will serve as an open space area and can be renovated with trail improvements and fitness equipment. In terms of park service radius, there is a deficiency according to the City's current park service radius models in open space and neighborhood park for this area. This will leave an open space deficiency along the eastern side of the High Pines / Ponce Davis area and southwest portion of the area. Riviera Park and Pinewood Cemetery serve a portion of the area as neighborhood park and open space, but there is still a deficiency in neighborhood parks in the southeastern portion of the area. The City plans to acquire park land in the High Pines / Ponce Davis area to cure the deficiencies and bring the area up to the Coral Gables park standards. The City also offers recreation programs near the area at William H. Kerdyk, Family Park and Jaycee Park. This programming would also be expanded into the area. In addition, annexation will open the many existing City recreational venues to High Pines / Ponce Davis residents at reduced rates.

The City will be able to provide enhanced residential solid waste collection services compared to the current County services. The County Solid Waste Department provides two (2) weekly garbage pick-ups on the street, recycling collection once per week, and bulky waste pick-up twice per year. Coral Gables has garbage pick-up twice per week at the side of the house and provides recycling and bulky waste services once per week.

Planning and zoning services are very important to residents and other property owners in High Pines / Ponce Davis. The proposed future land use and zoning patterns envisioned by the City were discussed previously in Section II of this application. High Pines / Ponce Davis will benefit greatly from planning that serves to incorporate it into a cohesive whole with its adjacent City neighborhoods to the north, east and south.



Local general government services will be much closer and accessible with annexation. City Hall is 4 miles from High Pines / Ponce Davis traveling, while the County's downtown Administrative Center is 10+ miles from the area. The City also has a full-time "ombudsman" who is available to help residents and business owners with all governmental needs, especially permitting.

If annexation occurs, the management of roads and stormwater facilities in High Pines / Ponce Davis would be transferred to the City. The Coral Gables Public Works Department has a long track record in effectively and efficiently managing these infrastructure systems. The City plans to resurface local roadways and improve the drainage system where needed. In addition, cracked sidewalks would be repaired and new sidewalks installed where gaps exist with input from area residents. Extensive tree plantings and landscape maintenance will also be conducted along the streets in High Pines / Ponce Davis on a regular basis.

#### **Insignificant Fiscal Impact on Miami-Dade County**

This annexation will have an insignificant impact on the County's UMSA budget, reducing it by an estimated \$2.13 million annually in property tax revenue. In exchange for that relatively small amount of revenue loss compared to the overall County budget, the County will be able to forego the cost of providing police, fire and emergency medical, parks and recreation, solid waste, general government, local road maintenance and stormwater management services to a 765-acre complete unincorporated enclave. The total assessed value of High Pines / Ponce Davis property is approximately \$1.24 billion, which is equal to approximately 0.5% of the overall Miami-Dade County tax base of \$250 billion.

#### **Meets Code Guidelines for PAB Review**

The annexation of High Pines / Ponce Davis complies with all nine (9) guidelines for Planning Advisory Board (PAB) review contained in Section 20-6(b) of the County Code as discussed below.

1. It does not divide a historically-recognized community.
2. High Pines / Ponce Davis is compatible with the existing planned land uses and zoning of the City.
3. The Area is not part of any federal/state enterprise zones, or targeted area by public agencies.
4. Public safety responses times will be significantly improved with annexation.
5. Annexation will not introduce any barriers to municipal traffic circulation.
6. High Pines / Ponce Davis will be served by the same public service franchises as the City, to the degree possible.
7. City is prepared to address any extraordinary emergency evacuation needs of High Pines / Ponce Davis.
8. High Pines / Ponce Davis is well connected to City offices and commercial centers by public transportation.

9. High Pines / Ponce Davis will remain in the same school district as current City residents to the degree possible.

**Complies with County Commission Review Guidelines**

The City's annexation application is also consistent with the eleven (11) guidelines for review by the Board of County Commissioners contained in Section 20-7(A) of County Code as discussed below.

(1) Cohesive and Inclusive Boundaries. (a) The annexation does not divide a U. S. Census Designated Place; (b) no ethnic minority and/or lower income residents have petitioned the City to be included that are not already in High Pines / Ponce Davis; (c) High Pines / Ponce Davis is contiguous to the City of Coral Gables on three (3) sides and actually eliminates a complete unincorporated enclave as the City of South Miami borders the 4<sup>th</sup> side; and (d) natural and/or built barriers, such as existing roadways and section lines, were used to the extent feasible in planning the proposed boundary.

(2) Property Tax Cost. The current adopted millage rate for the City of Coral Gables is 5.5590 mills. The current County Urban Municipal Service Area (UMSA) tax rate for unincorporated property owners is 1.9283 mills. If the High Pines / Ponce Davis neighborhood is annexed into Coral Gables, the property owners of the area would begin paying the City's millage rate of 5.5590 mills and the County's UMSA rate (1.9283 mills) would be removed along with the County's Fire District operations rate of 2.4207 mills, leaving a difference of 1.210 mills in additional property tax. Also, single-family homeowners would be charged \$869 per year for City residential solid waste services and they would cease paying the County's waste fee of \$464 per year. It should be noted that Coral Gables offers a discounted residential solid waste fee rate of \$743 for early payment, a savings of \$126. Finally, High Pines / Ponce Davis homeowners, if annexed, would also be assessed the City's \$70/year fire service fee. The figures below show the net annual financial impact on homeowners with annexation for a range of taxable property values, and include additional property tax, increased solid waste fee and the City's fire fee. The estimates below assume 50% of High Pines / Ponce Davis homeowners will take advantage of the City's waste fee 'early pay' option.

<u>Taxable Value</u>	<u>Estimated Additional Homeowner Cost</u>
\$500,000.....	\$1,042/year
\$1,250,000.....	\$1,950/year
\$2,000,000.....	\$2,860/year
\$2,750,000.....	\$3,760/year

(3) Urban Development Boundary. The entire High Pines / Ponce Davis annexation area is well within the County's established Urban Development Boundary (UDB).

(4) Impact on UMSA. This annexation will have an insignificant impact on the UMSA revenue base, reducing it by an estimated \$2.13 million annually. With this comparatively modest revenue reduction, the County will be able to terminate police, parks and recreation, general government, local road maintenance and stormwater management services to a 675-acre complete enclave area. The annexation will not adversely impact the County's ability to efficiently and effectively provide service to remaining unincorporated areas, and in fact should increase overall efficiency by allowing the County to refocus resources to service other non-enclave unincorporated areas closer to its district service centers.

(5) Per Capita Taxable Value. The 2018 taxable property value of all High Pines / Ponce Davis properties is \$1.104 billion, and its estimated population is 2,960. Using these figures, the per capita taxable value of the area is \$372,973. In order to assure fiscal viability is maintained in the unincorporated area, the County Code states that per capita taxable property value should fall within the range of \$20,000-\$48,000. However, the Code goes on to say that this standard shall not apply to unincorporated enclave areas and, as stated previously, High Pines / Ponce Davis is a complete enclave surrounded on three (3) sides by Coral Gables and on the fourth side by South Miami.

(6) Other Factors. This guideline is not applicable.

(7) Special or Unique Circumstances. There are a number of unique circumstances associated with this potential annexation. First and foremost, as discussed earlier, it would eliminate an unincorporated enclave which is a primary criterion of the County's annexation regulations. Coral Gables jurisdiction exists on three (3) sides of High Pines / Ponce Davis today putting the City in best position to serve the area. The City of South Miami is located on the 4<sup>th</sup> side making High Pines / Ponce Davis a complete enclave. In addition, the result of mail surveys to registered voters in the area conducted by the City in the last seven (7) months showed that 60% of respondents favor annexation to Coral Gables.

(8) Designated Terminals. High Pines / Ponce Davis contains no areas designated as terminals on the County's Adopted Land Use Plan Map.

(9) Regulatory Authority over Designated Terminals. High Pines / Ponce Davis contains no areas designated as terminals on the County's Adopted Land Use Plan Map.

(10) Impact of Annexation on Businesses. From a financial viewpoint, High Pines / Ponce Davis businesses that own property will pay an additional 1.21 mills on their property tax bills annually and the City's fire fee. The City's fire fee for non-residential buildings varies according to building size. The figures below show the net annual financial impact on business owners with annexation for a range of taxable property values and includes additional property tax and the City's fire fee. The fire fee was estimated using building sizes

of 4,000 square feet for \$75,000 value, 7,000 square feet for \$150,000 value, 12,000 square feet for \$250,000 value and 17,000 square feet for \$350,000 value.

<u>Property Value</u>	<u>Estimated Additional Business Owner Cost</u>
\$75,000.....	\$255/year
\$150,000.....	\$550/year
\$250,000.....	\$957/year
\$350,000.....	\$1,438/year

With respect to zoning regulations, business owners will benefit greatly from the City's Commercial zoning district. This City district generally permit the same uses as the County's BU districts. In addition, the City Commercial district contains a smaller minimum lot size standard (2,500 square feet) than the corresponding County business districts (5,000 square feet). The City Commercial district has no maximum lot coverage requirement while the County districts limit coverage to no more than 40%. County business districts have a minimum front setback standard of 20 feet, while the City C Commercial District requires 0-10 feet. The County's BU-1A district has a height limit of four (4) stories (44 feet), while the City's Commercial district limits height to 50-77 feet.

(11) Community Redevelopment Agency. There is no Community Redevelopment Agency operating in the High Pines / Ponce Davis area.

### **III. Service Provision**

High Pines / Ponce Davis is located within City of Coral Gables service areas for all of its existing municipal functions that already serve neighborhoods situated on three (3) sides of the area. The City's service provision plan is outlined below.

#### **Police Protection**

For police services, the area would be served within the City Police Department's Zone 9. Over the past three (3) years, the average City Police response time to calls in and around High Pines / Ponce Davis has been five (5) minutes; non-emergency call response has averaged eight (8) minutes. The property owners in the southeast portion of this area, generally located south of Davis Road (SW 80<sup>th</sup> Street) and east of SW 52<sup>nd</sup> Avenue, are part of the "Ponce Davis Roving Patrol District" which provides enhanced public safety and security at an annual cost of \$1,691 per year per property. With annexation and the provision of City public safety services, district residents will have a choice whether to continue the security district or rely solely on City police. The City Police Department plans to hire three (3) additional sworn officers and one (1) neighborhood service aide to service the High Pines / Ponce Davis area plus acquire additional vehicles and equipment for that personnel.

#### **Fire Protection**

Currently, the High Pines / Ponce Davis neighborhood is part of the County Fire Service District. If annexation occurs, fire and emergency medical services for High Pines / Ponce Davis would be transferred to the Coral Gables Fire Department. Coral Gables Station #2 is located at 525 South Dixie Highway, two (2) miles from the neighborhood, with two (2) fire engines, one (1) ladder truck and one (1) rescue truck. The average City fire and emergency medical response time is six (6) minutes. The Department is in the initial stages of identifying potential sites for a new fire station (#4) near the High Pines / Ponce Davis area. When operational, this new station will provide improved service for High Pines / Ponce Davis and other nearby areas of south Coral Gables. A fire engine and associated personnel, currently in service, would be relocated to staff the proposed fire station. Thus, in the initial phase of the annexation, the Fire Department would provide services to the High Pines / Ponce Davis area utilizing current Fire Department facilities, equipment and staffing levels. Eventually, the area would call for the addition of a rescue unit in order to achieve a fire engine and rescue unit configuration commensurate with the minimum staffing of all other fire stations in the City. The phase-in of the staffing and unit would be planned with the Finance Department as part of a multi-year Capital Improvement Plan. Over the long-term, six (6) additional firefighters as well as the procurement of a vehicle will be necessary to properly staff a rescue unit 24 hours a day on an annual basis. The City is committed to making the fire and EMS service enhancements to ensure the continuation of the same high level of service enjoyed by current residents.

**Water Supply and Distribution**

Water supply and distribution services will continue to be provided by the Miami-Dade County Water and Sewer Authority Department.

**Collection and Treatment of Wastewater**

Wastewater collection and treatment will continue to be provided by the Miami-Dade County Water and Sewer Authority Department.

**Garbage and Refuse Collection and Disposal**

Garbage and refuse collection and disposal services will be transferred to the Coral Gables Public Works Department, which is currently responsible for providing these services throughout the City. Coral Gables is prepared to hire additional sanitation workers and acquire equipment as needed to ensure responsive and efficient services.

**Electric Service and Street Lighting**

Florida Power and Light (FPL) provides electric service and the street lighting system in High Pines / Ponce Davis and throughout Coral Gables. It is expected FPL will continue to provide these services to High Pines / Ponce Davis with annexation. It is also anticipated that the standards for future street lighting in High Pines / Ponce Davis would be fully consistent with the Florida Building Code and State Energy Code.

**Street Construction and Maintenance**

City of Coral Gables will provide construction and maintenance services for municipal roads. The Interlocal Agreement between the County and City for the annexation will detail which roads and associated rights-of-way in High Pines / Ponce Davis will be transferred to Coral Gables and which roads that will remain under Miami-Dade County ownership. The City also plans to repair existing sidewalks and install new sidewalks on an as needed basis with input from area residents, as well as install and maintain street trees.

**Park and Recreation Facilities and Services**

Park and recreation facilities and services will be provided by the City's Parks and Recreation Department if annexation occurs. The High Pines / Ponce Davis area needs a neighborhood park and urban open spaces in order to meet the City's park level-of-service criteria and goals. The City would like to purchase land for the park and develop it over a 3-year period following annexation. In addition, two (2) passive urban

open spaces should also be acquired and developed over six (6) years. This neighborhood does not have any current recreation facilities or parks that offer recreation programming. Thus, the City will begin offering local recreational programs to High Pines / Ponce Davis residents upon annexation. Resident input will be solicited following annexation on any planned park facilities and/or recreational programs for the area.

### **Building Permitting and Inspection**

The City maintains a full-service Building Division within the Development Services Department that processes building permits, conducts building inspections, and issues citations for Building Code violations. In addition, the City's full-time "ombudsman" is very helpful with permitting questions and issues. These City services would be much closer to the property owners and residents of High Pines / Ponce Davis than similar services now provided by Miami-Dade County at the downtown County Administrative Center. All applicable federal, state, regional and county stormwater management and environmental permits are required to be obtained prior to the issuance of any City building permit.

### **Zoning Administration**

The City of Coral Gables provides full zoning services to its residents via its Planning and Zoning Division within the Development Services Department. With annexation, the same services would be available to High Pines / Ponce Davis residents and businesses. The Code Enforcement Division is planning to add one (1) Code Enforcement Officer and a Code Enforcement Assistant (0.5 of a position) to help monitor and enforce zoning and building code requirements in the High Pines / Ponce Davis area.

### **Local Planning Services**

Comprehensive planning services in the City are also provided by the Planning and Zoning Division of the Development Services Department. Coral Gables would provide these services to High Pines / Ponce Davis property owners upon annexation.

### **Stormwater Management**

The City of Coral Gables Public Works Department maintains the local drainage system throughout the City currently and will provide the same service level to the High Pines / Ponce Davis area upon annexation. The Interlocal Agreement between the County and City for the annexation will detail which canals and other drainage facilities will be transferred to Coral Gables and which stormwater facilities that will remain under Miami-Dade County jurisdiction.

**General Government**

The City of Coral Gables was established in 1925 with the approval of its Charter by the Florida Legislature. It is governed by an elected Mayor and four (4) City Commissioners. The City provides the full spectrum of general government services and would extend those services to High Pines / Ponce Davis upon annexation.



#### IV. Timetable for Supplying Services

Pursuant to Section 20-3(F) (3) of the County Code, a timetable for City services to be available to High Pines / Ponce Davis is required and provided in the chart below.

**Timetable for the Provision of City Services**

Service	Timeframe*
Police Protection	Within 9-12 months
Fire Protection	Within 9-12 months
Water Supply and Distribution	(County)
Collection and Treatment of Wastewater	(County)
Garbage and Refuse Collection and Disposal	Within 9-12 months
Electric Service and Street Lighting	(FPL)
Street Construction and Maintenance	Within 9-12 months
Park and Recreation Facilities and Services	Within 9-12 months
Building Inspection	Within 9-12 months
Zoning Administration	Within 9-12 months
Local Planning Services	Within 9-12 months
Stormwater Management	Within 9-12 months
General Government	Within 9-12 months

\* The City is requesting a 9-12 month period between final annexation approval and the actual implementation of City services above in High Pines / Ponce Davis to allow for the transition of revenue sources concurrent with the associated provision of services, and the acquisition of vehicles/equipment, transfer of zoning and other records, and training of new personnel.

## **V. Financing of Services**

Financing of the services listed in Section V are detailed below.

### **Police Protection**

The Coral Gables Police Department is funded through the City's General Fund. If the High Pines / Ponce Davis area is annexed into the City, property tax collections from the area will help pay for police and public safety services needed.

### **Fire Protection**

Fire protection and emergency medical services are funded through a combination of General Fund revenues and the City fire fee. If High Pines / Ponce Davis is annexed into the City, property taxes and fire fee collections from the area will help pay for fire and emergency medical services needed.

### **Water Supply and Distribution**

The Miami-Dade County Water and Sewer Authority Department will continue to provide water supply and distribution services to the High Pines / Ponce Davis area.

### **Collection and Treatment of Wastewater**

The Miami-Dade County Water and Sewer Authority Department will continue to provide wastewater collection and treatment services to the / area.

### **Garbage and Refuse Collection and Disposal**

Garbage and refuse collection and disposal is provided by the Coral Gables Public Works Department and funded via the City's solid waste fee. If High Pines / Ponce Davis is annexed, solid waste services in the area would be financed through solid waste fee collections.

### **Street Lighting**

Electric service and street lighting is provided by Florida Power and Light (FPL) through user fees.

### **Street Construction and Maintenance**

Street construction and maintenance is funded through the City's General Fund, local sales tax revenues

and impact fees. Also, private developers are required in some instances to construct/resurface roads to meet the City's level-of-service standards. Upon annexation, this service would be funded from the same sources.

### **Parks and Recreation Facilities and Services**

Parks and recreation facilities and services are funded by the City's General Fund and impact fees. If High Pines / Ponce Davis is annexed, parks and recreation facilities and services would be funded via the same sources.

### **Building Permitting and Inspection**

Building permits and inspections are paid for by permit fees collected from developers, owners, and residents as project applications are submitted. Upon annexation, this service would be funded through the same sources.

### **Zoning Administration**

Zoning administration services are funded by fees collected from developers, owners and residents with the submittal of project applications, as well as the City's General Fund. Upon annexation, this service would be funded through the same sources.

### **Local Planning Services**

Local planning services are funded from the City's General Fund and from fees collected from private developers and property owners seeking Comprehensive Plan amendments. Upon annexation, this service would be funded through the same sources.

### **Stormwater Management**

Stormwater management and maintenance is funded through the City's General Fund. Also, private developers are required in some instances to make drainage improvements in the public right-of-way to meet the City's stormwater level-of-service standards. Upon annexation, this service would be funded through the same sources.

### **General Government**

General government services are funded from the City's General Fund and, if High Pines / Ponce Davis is annexed, they would be funded from the same sources.

**VI. Tax Load**

According to recent information obtained from the Miami-Dade County Property Appraiser's Office, the total 2018 property value in High Pines / Ponce Davis is \$1.240 billion and the area's total taxable property value was \$1.104 billion. Based on these figures, the potential property tax revenue from High Pines / Ponce Davis for the City would be approximately \$6,137,100 annually, while the annual property tax loss for the Miami-Dade County UMSA budget would be an estimated \$2,128,800.

**Financial Impact on Homeowners and Business Owners**

The current adopted millage rate for the City of Coral Gables is 5.5590 mills. The existing County Urban Municipal Service Area (UMSA) tax rate for unincorporated property owners is 1.9283 mills. If the High Pines / Ponce Davis neighborhood is annexed into Coral Gables, the property owners of the area would begin paying the City's millage rate of 5.5590 mills and the County's UMSA rate (1.9283 mills) would be removed from their annual tax bills along with the County's Fire District operations rate of 2.4207 mills, leaving a difference of 1.210 mills in additional property tax. Also, single-family homeowners would be charged \$869 per year for City residential solid waste services and they would cease paying the County's waste fee of \$464 per year. It is relevant to note that Coral Gables offers a discounted residential solid waste fee rate of \$743 for early payment, a savings of \$126. Finally, High Pines / Ponce Davis homeowners, if annexed, would be assessed the City's \$70/year fire service fee. The figures below show the estimated net annual financial impact on homeowners upon annexation for a range of taxable property values, and include additional property tax, increased solid waste fee and the City's fire fee. The residential figures below assume 50% of High Pines / Ponce Davis homeowners will take advantage of the City's waste fee 'early pay' option.

<u>Taxable Value</u>	<u>Estimated Additional Homeowner Cost</u>
\$500,000.....	\$1,042/year
\$1,250,000.....	\$1,950/year
\$2,000,000.....	\$2,860/year
\$2,750,000.....	\$3,760/year

The financial impact on business owners upon annexation is presented below for a range of taxable property values and include additional property tax and the City's fire fee. The fire fee for business owners was estimated using building sizes of 4,000 square feet for \$75,000 value, 7,000 square feet for \$150,000 value, 12,000 square feet for \$250,000 value and 17,000 square feet for \$350,000 value.

---

<u>Property Value</u>	<u>Estimated Additional Business Owner Cost</u>
\$75,000.....	\$255/year
\$150,000.....	\$550/year
\$250,000.....	\$957/year
\$350,000.....	\$1,438/year

## VII. Conclusion

Coral Gables is in the best position to serve the unincorporated enclave of High Pines / Ponce Davis. The City is a full-service municipal government serving its residents for 90+ years. The points below summarize the reasons why this annexation proposal is good for both Coral Gables and Miami-Dade County.

- A complete unincorporated enclave surrounded on three (3) sides by Coral Gables and one (1) side by South Miami will be eliminated.
- Coral Gables is in the unique position to provide significantly more cost-effective, accessible and enhanced governmental services to High Pines / Ponce Davis property owners, businesses and residents.
- Police, and fire and emergency medical response times will be significantly reduced, and these services will be much more accessible to High Pines / Ponce Davis residents and businesses.
- City Hall is within 4 miles of High Pines / Ponce Davis, much closer and accessible to residents than the County's downtown Administrative Center 10+ miles away).
- The City plans to improve roads, drainage, parks and public landscaping in High Pines / Ponce Davis.
- The fiscal impact on the County's budget will not be significant.
- Miami-Dade County service costs associated with High Pines / Ponce Davis will be eliminated.
- The High Pines / Ponce Davis annexation application is fully consistent, and in compliance, with all applicable PAB and BOCC annexation review guidelines contained in County Code Sections 20-6 and 20-7.

For the reasons listed above and other supporting information presented in this application, the City formally requests that the Miami-Dade County Board of County Commissioners approve the annexation of the High Pines / Ponce Davis area into the jurisdiction of the City of Coral Gables and call for a special election for High Pines / Ponce Davis voters to consider the annexation question.

**Exhibit A**

**CORAL GABLES COMMISSION RESOLUTION NO. 2018-105**

**CITY OF CORAL GABLES, FLORIDA**

**RESOLUTION NO. 2018-105**

A RESOLUTION OF THE CITY COMMISSION OF CORAL GABLES APPROVING THE SUBMISSION OF AN APPLICATION TO MIAMI-DADE COUNTY FOR THE ANNEXATION OF THE AREA KNOWN AS HIGH PINES/PONCE-DAVIS INTO THE CITY OF CORAL GABLES PURSUANT TO CHAPTER 20 OF THE MIAMI-DADE COUNTY CODE AND REQUESTING MIAMI-DADE COUNTY APPROVE THE APPLICATION.

**WHEREAS**, the boundaries of the High Pines/Ponce-Davis are described in Exhibit A and graphically-depicted in Exhibit B; and

**WHEREAS**, the City of Coral Gables (City) has prepared an Annexation Feasibility Report showing the projected revenues, costs and service impacts associated with the annexation of the High Pines/Ponce-Davis area; and

**WHEREAS**, the City conducted an advertised public community meeting regarding the annexation of High Pines/Ponce Davis area at the Riviera Presbyterian Church on the evening of June 6, 2017 attended by 197 persons; and

**WHEREAS**, Coral Gables has received 648 signed petitions supporting annexation representing 27.9% of all voters; and

**WHEREAS**, the City Commission has determined that the annexation of the High Pines/Ponce-Davis area is in the best long-term interest of the City of Coral Gables;

**NOW, THEREFORE, BE IT RESOLVED BY THE COMMISSION OF THE CITY OF CORAL GABLES, FLORIDA:**

**SECTION 1.** That the foregoing "WHEREAS" clauses are hereby ratified and confirmed as being true and correct and are hereby made a specific part of this Resolution upon adoption hereof.

**SECTION 2.** That the City Manager and City Attorney are hereby directed to complete and submit a full application for the annexation of the High/Pines Ponce-Davis Area to Miami-Dade County pursuant to Chapter 20, of the Code of Miami-Dade County.

**SECTION 3** That this Resolution shall become effective immediately upon the date of its passage and adoption herein.



PASSED AND ADOPTED THIS TWENTY-SEVENTH DAY OF MARCH, A.D., 2018.  
(Moved: Quesada / Seconded: Lago)  
(Yeas: Mena, Quesada, Keon, Lago, Valdes-Fauli)  
(Unanimous: 5-0 Vote)  
(Agenda Item: F-7)

APPROVED:

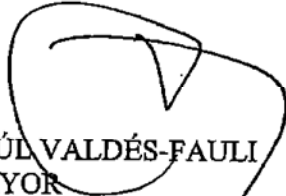

RAÚL VALDÉS-FAULI  
MAYOR

ATTEST:

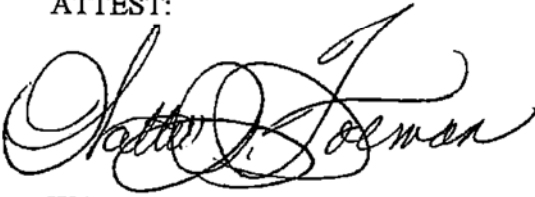

WALTER J. FOEMAN  
CITY CLERK

APPROVED AS TO FORM  
AND LEGAL SUFFICIENCY:



MIRIAM SOLER RAMOS  
CITY ATTORNEY

**EXHIBIT A**

High Pines/Ponce Davis  
General Boundary Description

North: Southwest 72<sup>nd</sup> Street and San Ignacio Avenue.

East: Southwest 47<sup>th</sup> Avenue and Mindello Street

South: Southwest 88<sup>th</sup> Street

West: Southwest 57<sup>th</sup> Avenue.

I, HEREBY CERTIFY that the foregoing (Pages 1 - 4, inclusive) is a true and correct copy of the original on file in this office.

EXHIBIT B

DATE 4/11/2018  
DEPUTY CITY CLERK [Signature]

Proposed High Pines / Ponce Davis Annexation Area

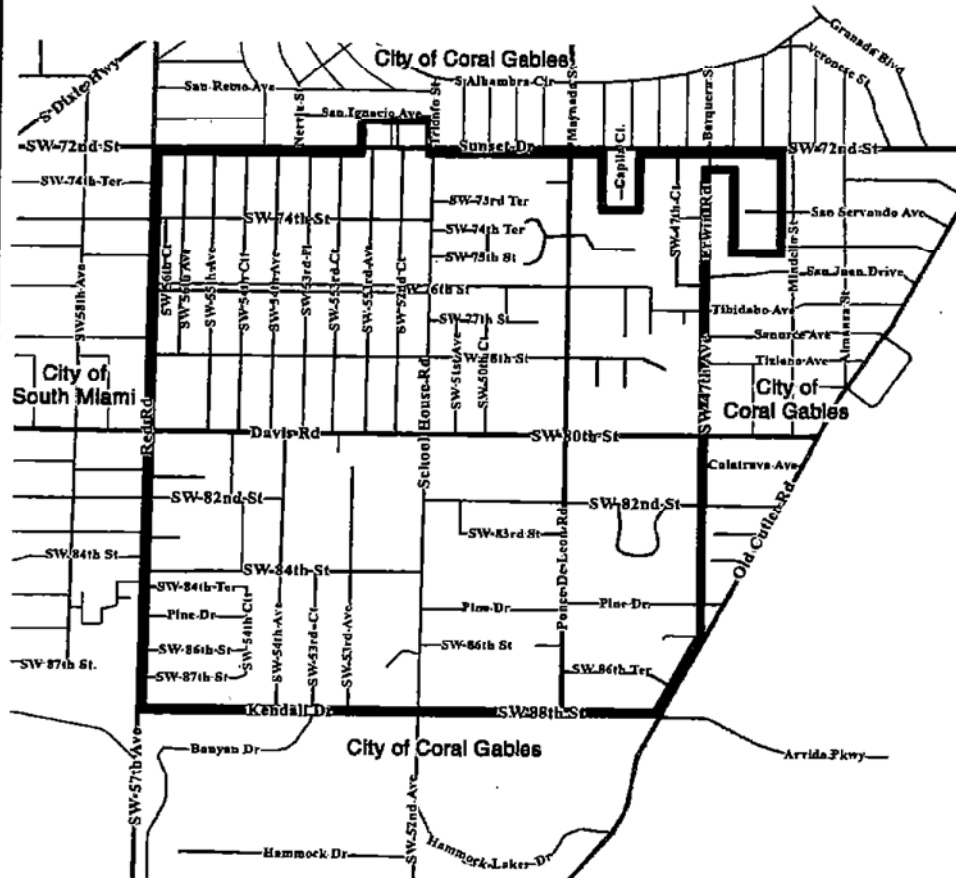

Prepared By:  
**ILER**  
PLANNING

4

**Exhibit B**

**BOUNDARY DESCRIPTION OF HIGH PINES / PONCE DAVIS AREA**

**High Pines / Ponce Davis**  
**General Boundary Description**

North: SW 72<sup>nd</sup> Avenue and San Ignacio Avenue

East: SW 47<sup>th</sup> Avenue and Mindello Street

South: SW 88<sup>th</sup> Street

West: SW 57<sup>th</sup> Avenue

**Exhibit C**

**CERTIFICATE OF PUBLICATION OF PUBLIC HEARING NOTICES**

**MIAMI DAILY BUSINESS REVIEW**

Published Daily except Saturday, Sunday and  
Legal Holidays  
Miami, Miami-Dade County, Florida

STATE OF FLORIDA  
COUNTY OF MIAMI-DADE:

Before the undersigned authority personally appeared KESHA BASSUE, who on oath says that he or she is the LEGAL CLERK, Legal Notices of the Miami Daily Business Review f/k/a Miami Review, a daily (except Saturday, Sunday and Legal Holidays) newspaper, published at Miami in Miami-Dade County, Florida; that the attached copy of advertisement, being a Legal Advertisement of Notice in the matter of

NOTICE OF PROPOSED RESOLUTION - CITY OF CORAL GABLES - MAR 27, 2018

In the XXXX Court,  
was published in said newspaper in the issues of

03/16/2018

Affiant further says that the said Miami Daily Business Review is a newspaper published at Miami, in said Miami-Dade County, Florida and that the said newspaper has heretofore been continuously published in said Miami-Dade County, Florida each day (except Saturday, Sunday and Legal Holidays) and has been entered as second class mail matter at the post office in Miami in said Miami-Dade County, Florida, for a period of one year next preceding the first publication of the attached copy of advertisement; and affiant further says that he or she has neither paid nor promised any person, firm or corporation any discount, rebate, commission or refund for the purpose of securing this advertisement for publication in the said newspaper.

*Kesha Bassue*

Sworn to and subscribed before me this  
16 day of MARCH, A.D. 2018

*Barbara Thomas*

(SEAL)

KESHA BASSUE personally known to me

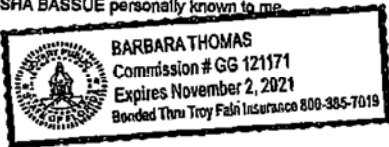

**THE CITY OF CORAL GABLES, FLORIDA  
NOTICE OF PROPOSED RESOLUTION**

The City Commission will hold a public hearing on Tuesday, March 27, 2018 at 10:00 a.m. in the City Hall Commission Chambers, 405 Biltmore Way, Coral Gables, FL 33134, to discuss the possible annexation of the High Pines/Ponce Davis area into the City of Coral Gables, and consider the adoption of a resolution to submit an application to the Board of County Commissioners requesting the annexation of the High Pines/Ponce Davis area as follows:

A RESOLUTION OF THE CITY COMMISSION OF CORAL GABLES APPROVING THE SUBMISSION OF AN APPLICATION TO MIAMI-DADE COUNTY FOR THE ANNEXATION OF THE AREA KNOWN AS HIGH PINES/PONCE DAVIS INTO THE CITY OF CORAL GABLES PURSUANT TO CHAPTER 20 OF THE MIAMI-DADE COUNTY CODE AND REQUESTING MIAMI-DADE COUNTY APPROVE THE APPLICATION.

Pursuant to Section 286.0105, Florida Statutes (2017), anyone wishing to appeal any decision made by the City Commission shall be required to ensure that a verbatim record of the proceedings is made, including all testimony and evidence upon which an appeal may be based.



WALTER J. FOEMAN  
CITY CLERK

Any person who needs assistance in another language in order to speak during the public hearing or public comment portion of the meeting should contact the City's Non-Discrimination Coordinator Raquel Elejabarreta, Esq., Director of Labor Relations and Risk Management (E-mail: [relejabarreta@coralgables.com](mailto:relejabarreta@coralgables.com) at (305) 722-8686, TTY/TDD: 305-460-5010), at least three (3) business days before the meeting.

Any person with a disability requiring communication assistance (such as a sign language interpreter or other auxiliary aid or service), in order to attend or participate in the meeting should contact the City's ADA Coordinator, Raquel Elejabarreta, Esq., Director of Labor Relations and Risk Management (E-mail: [relejabarreta@coralgables.com](mailto:relejabarreta@coralgables.com), Telephone: (305) 722-8686, TTY/TDD: 305-460-5010), at least three (3) days before the meeting. Additional information on the City's procedure to request any accommodations is located on the City's website under the "ADA Notice" tab.  
3/16 18-86000030437SM



Discover. Connect. Compete.

ALM Media, LLC  
PO Box 936174  
Atlanta, GA 31193-6174

2018 MAR 20 PM 2:13  
OFFICE OF THE CLERK

**Daily Business Review**

Miami Dade

Customer No: 9005467

Please Remit To:

CITY OF CORAL GABLES  
Attention To: BILLY URQUIA  
WALTER J FOEMAN  
PO DRAWER 141549  
CORAL GABLES, FL 33114

Invoice #:	10000304373-0316
Invoice Date:	03/16/2018
Due Date:	Due Upon Receipt
<b>AMOUNT DUE:</b>	<b>\$107.35</b>

PLEASE RETURN THIS SECTION WITH PAYMENT

Amount Remitted

TEAR HERE

**Daily Business Review**

Miami Dade

Invoice Date: 03/16/2018	Customer #: 9005467
--------------------------	---------------------

Invoice #	Description	Amount
10000304373-0316	Placement/Position: Other Notices/Miscellaneous / Other Notices Run Dates: 03/16/2018 Ad Size: 2 x 6.02 Inches NOTICE OF PROPOSED RESOLUTION - CITY OF CORAL GABLES - MAR 27, 2018	\$107.35
	<b>Subtotal</b>	<b>\$107.35</b>
	<b>Total Due</b>	<b>\$107.35</b>

Payment By Credit Card		( ) Visa ( ) MC ( ) Amex	
Credit Card #: _____	Exp. Date: _____ / _____	Security Code: _____	
Card Holder Name: _____	Signature: _____		

For billing questions, please email: [ALMcollection@alm.com](mailto:ALMcollection@alm.com).  
Besides the email address you can fax us at 859-692-2209.





# Miami Herald

MEDIA COMPANY

PUBLISHED DAILY  
MIAMI-DADE-FLORIDA

STATE OF FLORIDA  
COUNTY OF MIAMI-DADE

Before the undersigned authority personally  
appeared:

**Jeannette Martinez**

who on oath says that he/she is

**CUSTODIAN OF RECORDS**

of The Miami Herald, a daily newspaper published at  
Miami in Miami-Dade County, Florida; that the attached  
copy of advertisement that was published was published in said  
newspaper in the issue of:

**March 25<sup>th</sup>, 2018**

Affiant further says that the said The Miami Herald  
is a newspaper published at Miami, in the said Miami-Dade  
County, Florida and that the said newspaper has  
heretofore been continuously published in said Dade  
County, Florida each day and has been entered as  
second class mail matter at the post office in Miami,  
in said Miami-Dade County, Florida, for a period of one  
year next preceding the first publication of the  
attached copy of advertisement; and affiant further  
says that he has neither paid nor promised any  
person, firm or corporation any discount, rebate,  
commission or refund for the purpose of securing  
this advertisement for publication in the said  
newspapers(s).

  
Sworn to and subscribed before me this  
11<sup>th</sup>, day of April, 2018

My Commission

Expires: \_\_\_\_\_ August 1, 2018 \_\_\_\_\_

Silvia Sendra

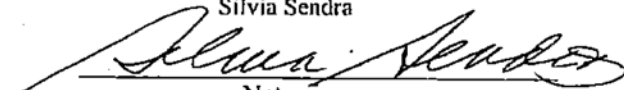
  
Notary



**THE CITY OF CORAL GABLES, FLORIDA  
NOTICE OF PROPOSED RESOLUTION**

The City Commission will hold a public hearing on Tuesday, March 27, 2018 at 10 AM in the City Commission Chambers, 405 Biltmore Way, Coral Gables, FL 33134, to discuss the possible annexation of the High Pines/ Ponce-Davis area into the City of Coral Gables, and consider the adoption of a resolution to submit an application to the Board of County Commissioners requesting the annexation of the High Pines/Ponce-Davis area as follows:

**A RESOLUTION OF THE CITY COMMISSION OF CORAL GABLES APPROVING THE SUBMISSION OF AN APPLICATION TO MIAMI-DADE COUNTY FOR THE ANNEXATION OF THE AREA KNOWN AS HIGH PINES/PONCE-DAVIS INTO THE CITY OF CORAL GABLES PURSUANT TO CHAPTER 20 OF THE MIAMI-DADE COUNTY CODE AND REQUESTING MIAMI-DADE COUNTY APPROVE THE APPLICATION.**

Pursuant to Section 286.0105, Florida Statutes (2017), anyone wishing to appeal any decision made by the City Commission shall be required to ensure that a verbatim record of the proceedings is made, including all testimony and evidence upon which an appeal may be based.



**WALTER J. FOEMAN  
CITY CLERK**

Any person who needs assistance in another language in order to speak during the public hearing or public comment portion of the meeting should contact the City's Non-Discrimination Coordinator Raquel Elejabarrieta, Esq., Director of Labor Relations and Risk Management (E-mail: [relejabarrieta@coralgables.com](mailto:relejabarrieta@coralgables.com) at (305) 722-8686, TTY/TDD: 305-460-5010), at least three (3) business days before the meeting.

Any person with a disability requiring communication assistance (such as a sign language interpreter or other auxiliary aide or service) in order to attend or participate in the meeting should contact the City's ADA Coordinator Raquel Elejabarrieta, Esq., Director of Labor Relations and Risk Management (E-mail: [relejabarrieta@coralgables.com](mailto:relejabarrieta@coralgables.com), Telephone: (305) 722-8686, TTY/TDD: 305-460-5010), at least three (3) days before the meeting. Additional information on the City's procedure to request any accommodations is located on the City's website under the "ADA Notice" tab.

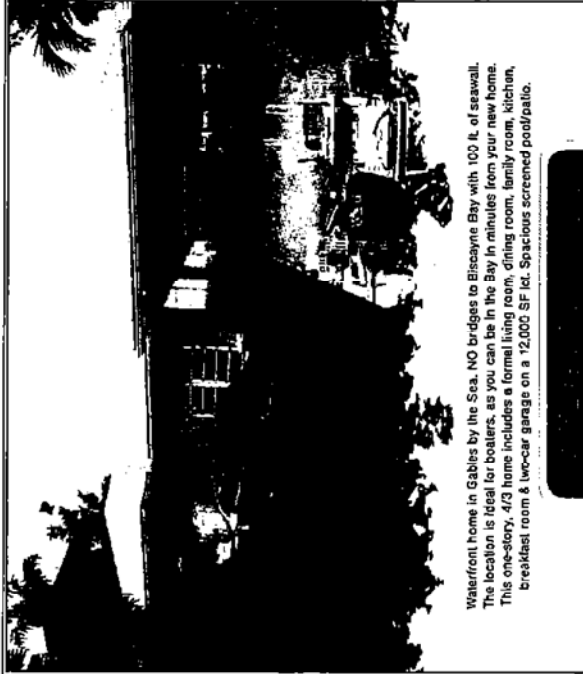

Waterfront home in Gables by the Sea. NO bridges to Biscayne Bay with 100 ft. of seawall. The location is ideal for boaters, as you can be in the Bay in minutes from your new home. This one-story, 4/3 home includes a formal living room, dining room, family room, kitchen, breakfast room & two-car garage on a 72,000 SF lot. Spacious screened pool/patio.

Call Martin Carneal (305) 796-4257 or Melissa LaRocca (305) 588-2314  
of James Spangor Realty Inc. for more information.



**18-Hole Course • Lit Driving Range • Mini-Golf • Party Rentals**

For info, call 305-238-2932 or visit [GOLFPALETTE.COM](http://GOLFPALETTE.COM).

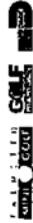

To receive media interest: Be formal, don't beg; be professional, and/or any accommodation to participate in any Miami-Dade News sponsored program or meeting, contact: Mary Buckle, 305-355-7848 or [marybuckle@news.miami.gov](mailto:marybuckle@news.miami.gov) at least 7 days in advance to make your request. TV spots may also be at 311, Florida Relay Service.

**Exhibit D**

**AFFIDAVIT CERTIFYING MAILING OF PUBLIC HEARING NOTICE TO AFFECTED  
PROPERTY OWNERS**

I, Michael Lopez, do hereby attest that I prepared the mailing labels for all property owners within the High Pines / Ponce Davis area along with 600 feet surrounding properties.

*Michael Lopez*

Michael Lopez, Information Technology Technician, City of Coral Gables

STATE OF FLORIDA/COUNTY OF

The foregoing instrument was acknowledged before me this 18<sup>th</sup> day of APRIL 2018 **MICHAEL LOPEZ**

*Lorena Garrido*  
(Signature of Notary Public - State of Florida)



(Print, Type or Stamp Commissioned Name of Notary Public)

Personally Known OR  Produced Identification; Type of Identification Produced \_\_\_\_\_

I, Jon S. Adkins of Adkins & Associates, do hereby attest that notices were mailed to all property owners within the High Pines / Ponce Davis area along with 600 feet surrounding properties based on the mailing labels mentioned above.

*Jon S. Adkins*  
Jon S. Adkins, Adkins & Associates

STATE OF FLORIDA/COUNTY OF

The foregoing instrument was acknowledged before me this 4<sup>th</sup> day of April by

*Solanch Lopez*  
(Signature of Notary Public - State of Florida)



(Print, Type or Stamp Commissioned Name of Notary Public)

Personally Known OR  Produced Identification; Type of Identification Produced \_\_\_\_\_

**Exhibit E**

**CERTIFICATE OF COUNTY SUPERVISOR OF REGISTRATION**



**Elections**  
2700 NW 87th Avenue  
Miami, Florida 33172  
T 305-499-8683 F 305-499-8547  
TTY 305-499-8480

miamidade.gov

## CERTIFICATION

STATE OF FLORIDA)

COUNTY OF MIAMI-DADE)

I, Christina White, Supervisor of Elections of Miami-Dade County, Florida, do hereby certify the proposed City of Coral Gables Annexation area known as High Pines/Ponce-Davis, as shown in the attached map, has 2,387 voters.

WITNESS MY HAND  
AND OFFICIAL SEAL,  
AT MIAMI, MIAMI-DADE  
COUNTY, FLORIDA,  
ON THIS 25<sup>th</sup> DAY OF  
APRIL, 2018

A handwritten signature in black ink, appearing to read "Christina White", written over a horizontal line.

Christina White  
Supervisor of Elections

# High Pines / Ponce - Davis Area

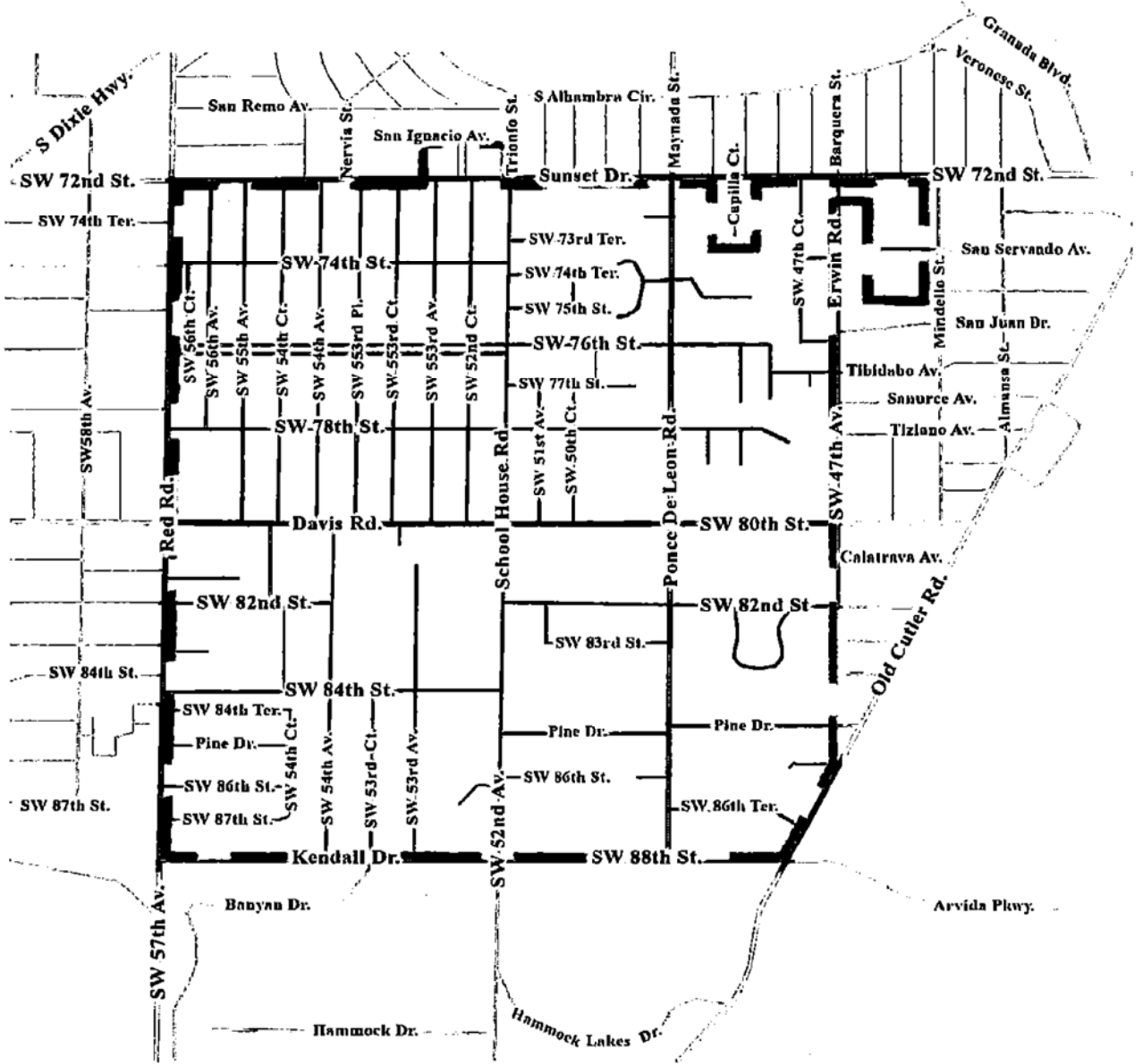

**Legend**

Annexation Area Boundary



Date: 6 - 8 - 17

Prepared By:

**ILER**  
PLANNING

**Exhibit F**

**APPLICABLE CITY FUTURE LAND USE DESIGNATIONS**





# Future Land Use Element

**Vision Statement:** Continue Coral Gables vision and mission as a community that is attractive to live, work, play and visit.

## Goals, Objectives and Policies:

**Goal FLU-1.** Protect, strengthen, and enhance the City of Coral Gables as a vibrant community ensuring that its neighborhoods, business opportunities, shopping, employment centers, cultural activities, historic value, desirable housing, open spaces, and natural resources make the City a very desirable place to work, live and play.

**Objective FLU-1.1.** Preserve Coral Gables as a “placemaker” where the balance of existing and future uses is maintained to achieve a high quality living environment by encouraging compatible land uses, restoring and protecting the natural environment, and providing facilities and services which meet or exceed the minimum Level of Service (LOS) standards and meet the social and economic needs of the community through the Comprehensive Plan and Future Land Use Classifications and Map (see FLU-1: Future Land Use Map).

**Policy FLU-1.1.1.** The City’s Future Land Use Classifications and Map shall describe, assign, and depict the future land uses found to be in the public interest and to be the basis for regulations, programs, actions and rules of the City and other affected agencies.

**Policy FLU-1.1.2** Residential land use classifications are as follows (Land use descriptions provided herein are general descriptions, refer to underlying/assigned Zoning Classification for the list of permitted uses):

Classification	Description	Density / Intensity	Height
Single-Family Low Density.	Single-family detached homes.	Maximum 6 units/acre.	Per the Zoning Code.
Single-Family High Density.	Single-family detached and attached homes, including townhouses.	Maximum 9 units/acre.	Per the Zoning Code.
Multi-Family Duplex Density.	Duplex homes, including townhouses.	Maximum 9 units/acre.	Per the Zoning Code.
Multi-Family Low Density.	Multi-family residential of low height and density.	Maximum 20 units/acre, or 25 units/acre with architectural incentives per the Zoning Code.	Up to 50’ maximum (no limitation on floors), or up to 77’ maximum (with a maximum of 2 additional floors) with architectural incentives per the Zoning Code.
Multi-Family Medium Density.	Multi-family residential of medium height and density.	Maximum 40 units/acre, or 50 units/acre with architectural incentives per the Zoning Code.	Up to 70’ maximum (no limitation on floors), or up to 97’ maximum (with a maximum 2 additional floors) with architectural incentives per the Zoning Code.
Multi-Family High Density.	Multi-family residential of high height and density.	Maximum 60 units/acre, or 75 units/acre with architectural incentives per the Zoning Code.	Up to 150’ maximum (no limitation on floors), or 190.5’ maximum (with a maximum 3 additional floors) with architectural incentives per the Zoning Code.

**Policy FLU-1.1.3.** Commercial land use classifications are as follows (Land use descriptions provided herein are general descriptions, refer to underlying/assigned Zoning Classification for the list of permitted uses):





# Future Land Use Element

Classification	Description	Density / Intensity	Height
Commercial Low-Rise Intensity.	This category is oriented to low intensity pedestrian and neighborhood commercial uses, including residential, retail, services, office, and mixed use.	Maximum F.A.R. of 3.0, or 3.5 with architectural incentives. Up to an additional 25% F.A.R. may be granted for properties qualifying as receiving sites for Transfer of Development Rights (TDRs).  Residential use shall only be permitted as part of a mixed-use development as provided herein.	Up to 50' maximum (no limitation on floors), or up to 77' maximum (with a maximum of 2 additional floors) with architectural incentives per the Zoning Code.
Commercial Mid-Rise Intensity.	This category is oriented to medium intensity pedestrian and neighborhood commercial uses, including residential, retail, services, office, and mixed use.	Maximum F.A.R. of 3.0, or 3.5 with architectural incentives. Up to an additional 25% F.A.R. may be granted for properties qualifying as receiving sites for Transfer of Development Rights (TDRs).  Residential use shall only be permitted as part of a mixed-use development as provided herein.	Up to 70' maximum (no limitation on floors), or up to 97' maximum (with a maximum 2 additional floors) with architectural incentives per the Zoning Code.
Commercial High-Rise Intensity.	This category is oriented to the highest intensity commercial uses, including residential, retail, services, office, and mixed use.	Maximum F.A.R. of 3.0, or 3.5 with architectural incentives. Up to an additional 25% F.A.R. may be granted for properties qualifying as receiving sites for Transfer of Development Rights (TDRs).  Residential use shall only be permitted as part of a mixed-use development as provided herein.	Up to 150' maximum (no limitation on floors), or 190.5' maximum (with a maximum 3 additional floors) with architectural incentives per the Zoning Code.

**Policy FLU-1.1.4.** Industrial land use classification is as follows (Land use descriptions provided herein are general descriptions, refer to underlying/assigned Zoning Classification for the list of permitted uses):

Classification	Description	Density / Intensity	Height
Industrial.	This category is oriented to industrial uses, including automotive services, wholesale, light industry, manufacturing, and all uses allowed in the Commercial land use categories.	Maximum F.A.R. of 3.0, or 3.5 with architectural incentives.  Residential use shall only be permitted as part of a mixed-use development as provided herein.	Up to 70' maximum (no limitation on floors), or up to 97' maximum (with a maximum 2 additional floors) with architectural incentives per the Zoning Code.

**Policy FLU-1.1.5.** Mixed-Use land use classifications are as follows (Land use descriptions provided herein are general descriptions, refer to underlying/assigned Zoning Classification for the list of permitted uses):

Classification	Description
MXD, Mixed-Use or MXOD, Mixed-Use Overlay Districts.	<p>Mixed uses are permitted to varying degrees in the multi-family residential, commercial, and industrial land use categories, pursuant to underlying land use regulations and applicable Zoning Code provisions.</p> <p>The general intent of the MXD is to promote a multi-faceted pedestrian friendly environment comprised of an assortment of uses, including the following:</p> <ul style="list-style-type: none"> <li>• Residential;</li> <li>• Retail/Commercial;</li> <li>• Office;</li> <li>• Industrial; and</li> <li>• Public Open Spaces.</li> </ul> <p>No single use may comprise more than eighty-five (85%) percent of the MXD floor area ratio.</p> <p>The proportionate mix of uses shall be reviewed per development application. The following table</p>

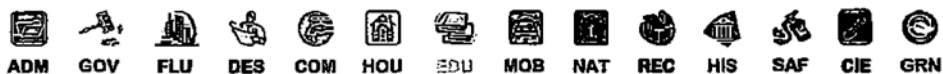



# Future Land Use Element

	<p>establishes minimum and maximum thresholds based upon the FAR of the building.</p> <table border="1"> <thead> <tr> <th>Type of Use</th> <th>Minimum % of FAR</th> <th>Maximum % of FAR</th> </tr> </thead> <tbody> <tr> <td>Residential</td> <td>0%</td> <td>85%</td> </tr> <tr> <td>Retail/Commercial</td> <td>8%</td> <td>40%</td> </tr> <tr> <td>Office</td> <td>0%</td> <td>85%</td> </tr> <tr> <td>Industrial</td> <td>0%</td> <td>5%</td> </tr> </tbody> </table> <p>Additional MXD or Mixed Use Overlay District (MXOD) development standards, including maximum densities, intensities, and height, are provided in the Zoning Code.</p>	Type of Use	Minimum % of FAR	Maximum % of FAR	Residential	0%	85%	Retail/Commercial	8%	40%	Office	0%	85%	Industrial	0%	5%
Type of Use	Minimum % of FAR	Maximum % of FAR														
Residential	0%	85%														
Retail/Commercial	8%	40%														
Office	0%	85%														
Industrial	0%	5%														
MXOD, Mixed-Use Overlay Districts.	<p>An MXOD may be permitted as an overlay in the Commercial and Industrial land use categories (see FLU-2: Mixed-Use Overlay District Map).</p> <p>Properties within the MXOD have the option of developing their property in accordance with the underlying land use. Assigned MXOD within the City are as follows:</p>															

**Policy FLU-1.1.6.** Other land use classifications are as follows (Land use descriptions provided herein are general descriptions, refer to underlying/assigned Zoning Classification for the list of permitted uses):

Classification	Description	Density / Intensity	Height	
University Campus	Land uses for learning, research, living and other uses which are ancillary to a university campus.	Maximum F.A.R. of 0.7 for the entire campus as a planned development site.	Per the Zoning Code.	
	<table border="1"> <thead> <tr> <th colspan="2">Sub Category</th> </tr> </thead> <tbody> <tr> <td>University Campus Multi-use Area</td> <td>In addition to the uses in Table FLU-5 hereinabove, this category shall include other land uses that are associated or affiliated with the university, or directly supportive of the university's mission to educate and nurture students, to create knowledge, and to provide service to the community. Such other uses shall include lodging, conference center, governmental/public sector, research, office, and medical/ healthcare uses. Retail uses ancillary to or which serve the other use(s) permitted in the University Campus and University Campus Multi-Use Area may be integrated in an amount not to exceed fifteen percent (15%) of the total floor area.</td> </tr> </tbody> </table>			Sub Category
Sub Category				
University Campus Multi-use Area	In addition to the uses in Table FLU-5 hereinabove, this category shall include other land uses that are associated or affiliated with the university, or directly supportive of the university's mission to educate and nurture students, to create knowledge, and to provide service to the community. Such other uses shall include lodging, conference center, governmental/public sector, research, office, and medical/ healthcare uses. Retail uses ancillary to or which serve the other use(s) permitted in the University Campus and University Campus Multi-Use Area may be integrated in an amount not to exceed fifteen percent (15%) of the total floor area.			
Education	Primary and secondary schools, both public and private.	Maximum F.A.R. of 2.0.	Per the Zoning Code.	
Parks and Recreation	Public/private land areas and buildings for recreation, both active and passive, including golf, tennis, and similar sporting and leisure activities.	Maximum F.A.R. of 2.0.	Per the Zoning Code.	
Open Space	Open space areas including right-of-way plazas and entranceways.	Maximum F.A.R. of 0.	N/A	
Conservation Areas	Environmentally sensitive areas such as marshes, swamps, mangroves, and natural wildlife habitats. Designated limited support facility development areas shall be restricted to passive support activities such as nature trails and restroom facilities. Proposals for limited development shall be reviewed on an individual basis.	Maximum F.A.R. of 0, except for designated areas specified for limited support facility development.	N/A	
Public Buildings and Grounds	Buildings and adjacent land areas used for local, state, or federal government purposes, and for public and semi-public services, including utilities.	Maximum F.A.R. of 2.0.	Per the Zoning Code.	
Hospital	Buildings and land areas used for medical and health related services.	Maximum F.A.R. of 2.0.	Per the Zoning Code.	
Religious / Institutional	Churches, temples, synagogues, houses of worship, fraternal organizations, and related accessory uses such as educational and child care services and private clubs,	Maximum F.A.R. of 2.0.	Per the Zoning Code.	





# Future Land Use Element

	country clubs and associated uses.		
Community Services and Facilities	Buildings and adjacent land areas that serve a public and/or community function, including local, state, and federal government facilities; public and private schools and educational facilities (excluding University); medical and health facilities; and religious institutions.	Maximum F.A.R. of 2.0.	Per the Zoning Code.
Historic Properties	Buildings, sites, and districts determined to be historically, architecturally, or archeologically significant by National Register listing or local landmark designation. Provides an overlay classification which supplements the underlying land use classification. The location of HP classified properties may be depicted on the Future Land Use Map series or on the Historic Preservation Map series as determined by the City.	Per underlying land use and Zoning Code provisions.	Per underlying land use and Zoning Code provisions.
Downtown Overlay	Provides an overlay classification which supplements the underlying land use classification. The location of the Downtown Overlay is depicted on the Future Land Use Map.	Per underlying land use and Zoning Code provisions.	Per underlying land use and Zoning Code provisions.

**Policy FLU-1.1.7.** A concurrency impact analysis is completed for all development orders issued by the City. This includes changes in use, building permits, and change in zoning or conditional use applications. Applicants are required to satisfy all concurrency conditions prior to issuance of a building permit.

**Policy FLU-1.1.8.** The City shall review on an annual basis the Concurrency Management System, including the adopted levels of services, to ensure that public facilities are available to meet the impacts of new development.

**Policy FLU-1.1.9.** From 2004-2007, the City completed a comprehensive rewrite of its Zoning Code regulations. The City shall annually review its Zoning Code regulations and make necessary changes in order to:

- Effectively regulate future land use activities and natural resources identified on the Future Land Use Map;
- Adequately protect property rights; and
- Implement the goals, objectives, and policies stipulated in the Comprehensive Plan.

**Policy FLU-1.1.10.** The City of Coral Gables shall prepare an Evaluation and Appraisal Report (EAR) for submittal to DCA as required by Chapter 163, F.S. as amended and Rule 9J-5, FAC as amended and pursuant to the schedule in 9J-33, FAC as amended.

**Objective FLU-1.2.** Efforts shall continue to be made to control blighting influences, and redevelopment shall continue to be encouraged in areas experiencing deterioration.

**Policy FLU-1.2.1.** The City's Zoning Code and City Code allow potential problems to be cited and require property owners of cited property to take remedial action.

**Objective FLU-1.3.** By the year 2015 the City shall endeavor to reduce the number of inconsistencies between the Future Land Use Map and the actual land uses from 40 to 20.

**Policy FLU-1.3.1.** Private properties desiring to develop or seek City development order reviews which have inconsistent land use and zoning classifications shall, as a part of the City's development review process, be required to undergo applicable City review for a change in land use and/or zoning to provide for consistent land and zoning designations. The determination as to the proper assignment of land use and/or zoning to correct the inconsistency shall be based on

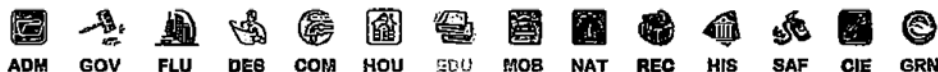

**Exhibit G**

**APPLICABLE CITY ZONING DISTRICT REGULATIONS**

## ARTICLE 4 - ZONING DISTRICTS

The chart on the proceeding page is a summary of the uses permitted in the following zoning districts:

<b>Zoning Districts</b>	<b>Zoning District Abbreviation</b>
Single-Family Residential District	SFR
Multi-Family 1 Duplex District	MF1
Multi-Family 2 District	MF2
Multi-Family Special Area District	MFSA
Mixed Use District	MXD
University Campus District	UCD
Special Use District	S
Preservation District	P
Commercial Limited District	CL
Commercial District	C
Industrial District	I
Downtown Overlay District	DO
Business Improvement Overlay District	BIOD
North Ponce Neighborhood Conservation Overlay District	NPCO
Residential Infill Regulations	RIR

The letter "P" indicates that the use is a permitted use in the district subject to approval as set out in Article 3 and in compliance with the standards in the district and Article 5 of these regulations. The letter "C" indicates that the use is permitted in the district as a conditional use in accordance with the procedures set out in Article 3, Division 4 and the standards in these regulations.

## ARTICLE 4 - ZONING DISTRICTS

Article 4 – Table No. 1. Zoning District Uses												
Use categories	Zoning Districts											
	SFR	MF1	MF2	MFSA	CL	C	I	MXD	S	UCD	P	
<b>Residential uses</b>												
Accessory uses, buildings, and structures (see Table No. 2 for list of permitted accessory uses)	P	P	P	P	P	P	P	See Section 4-201	P	See Section 4-202	See Section 4-205	
Single-family dwellings	P	P	P	P								
Duplex dwellings		P	P	P								
Multi-family dwellings			P	P								
Townhouse dwellings			P	P								
Live-work					P	P	P					
<b>Non-residential uses</b>												
Accessory uses, buildings, and structures (see Table No. 2 for list of permitted accessory uses)	P	P	P	P	P	P	P	See Section 4-201	P	See Section 4-202	See Section 4-205	
Adult uses							C					
Alcoholic beverage sales					P	P	P					
Animal grooming or boarding						P	P					
Assisted living facilities			C	C	C	C	C					
Auto service stations					C	P	P					
Bed and breakfast			C									
Botanical gardens									P/C			
Camps					P	P	P		C			
Cemeteries									C			
City Parks	P	P	P	P	P	P	P		P			
Commercial laundry							P					
Community center					C	P	P					
Congregate care					P	P						
Country club									C			
Day care						P	P					
Drive-through facilities					C	C						
Educational facilities					P/C	P						
Family day care	P	P	P	P								
Funeral homes						P						
Golf course (Primary use)									C			
Government uses						P	P		C			
Heliport									C			
Helistop						C	C		C			
Hospitals and uses accessory to . . .									C			
Indoor recreation / entertainment					P	P	P					
Manufacturing							P					
Marina facilities						C			C			
Medical clinic					P/C	P	P					
Medical Marijuana Retail Center						C						
Mixed use buildings						C	C					
Municipal facilities					P	P	P		C			
Museum					C	P	P		C			

## ARTICLE 4 - ZONING DISTRICTS

Article 4 – Table No. 1. Zoning District Uses												
Use categories	Zoning Districts											
	SFR	MF1	MF2	MFSA	CL	C	I	MXD	S	UCD	P	
Nighttime uses					C	P						
Nursing homes					P	P						
Offices					P	P	P					
Open space areas									C			
Outdoor recreation / entertainment					C	C	P					
Outdoor retail sales, display and/or storage							P					
Overnight accommodations					P/C	P	P					
Parking garages						P	P					
Parking lots					C	P	P					
Private club									C			
Private yacht basin	C	C	C			C						
Public transportation facility						P	P		C			
Religious institutions									C			
Research and technology uses							P					
Restaurants					P	P	P					
Restaurants, fast food						P	P					
Retail sales and service					P	P	P					
Sales and/or leasing offices												
Schools									C			
Self-storage warehouses							P					
Temporary uses					P	P	P		P			
Tennis court (Primary use)									C			
TV / radio studios						P	P					
Utility / infrastructure facilities	P	P	P	P	P	P	P		P			
Utility substations							P					
Vehicle sales / displays						P	P					
Vehicle sales / displays, major							P					
Vehicle service, major						P	P					
Veterinary offices						P	P					
Wholesale / distribution / warehouse facility							P					

P – Permitted Use  
C – Conditional Use



## ARTICLE 4 - ZONING DISTRICTS

Article 4 – Table No. 2. Zoning District Accessory Uses												
Accessory uses, buildings and structures categories	Zoning Districts											
	SFR	MF1	MF2	MFSA	CL	C	I	MXD	S	UCD	P	
Accessory dwelling	P										See Section 4-202	See Section 4-205
Antennae's and associated telecommunication uses	See Division 20. Telecommunications.											
Awnings and canopies	P	P	P	P	P	P	P	P	P	P		
Boathouse and/or boat slip	P											
Cabana	P											
Docks, davits and floating boat lifts	See Division 8. Dock, wharves, mooring piles, watercraft moorings.											
Drive-throughs, walk-up windows, and automated teller machines (ATM)	See Section 5-115. Drive-throughs, walk-up windows, and automated teller machines											
Emergency preparedness shelter	P	P	P	P	P	P	P	P	P	P		
Flagpoles	P	P	P	P	P	P	P	P	P	P		
Fountains.	P	P	P	P	P	P	P	P	P	P		
Garage and/or porte-cochere	P	P	P	P					P	P		
Gazebo	P	P	P	P					P	P		
Guesthouse (Residential Estate only)	See Section 5-105. Guesthouse.											
Greenhouse	P	P	P	P								
Massage establishment	See Section 5-117. Massage establishment.											
Permanently installed stand-by generators	P	P	P	P					P			
Planters	P	P	P	P	P	P	P	P	P	P		
Playhouse	P	P	P	P								
Recreational equipment	P	P	P	P	P	P	P	P	P	P		
Reflecting pool or fish pond	P	P	P	P	P	P	P	P	P	P		
Restaurant, open air	See Section 5-119. Restaurant, open air.											
Screened enclosures	P	P	P	P					P	P		
Storage building and/or utility room	P	P	P	P	P	P	P	P	P	P		
Swimming pool and/or spa	P	P	P	P	P	P	P	P	P	P		
Tennis courts	P	P	P	P					P	P		
Trellises	P	P	P	P	P	P	P	P	P	P		
Used car lot						P*						
Wood decks	P	P										

P – Permitted Use.

\*Permitted as an accessory use in association with a new car dealership.

## ARTICLE 4 - ZONING DISTRICTS

### Division 1. Residential Districts

#### Section 4-101. Single-Family Residential (SFR) District.

- A. Purpose and applicability. The Single-Family Residential (SFR) District is intended to accommodate low density, single-family dwelling units with adequate yards and open space that characterize the residential neighborhoods of the City. The City is unique not only in South Florida but in the country for its historic and architectural treasures, its leafy canopy, and its well-defined and livable neighborhoods. These residential areas, with tree-lined streets and architecture of harmonious proportion and human scale, provide an oasis of charm and tranquility in the midst of an increasingly built-up metropolitan environment. The intent of the Code is to protect the distinctive character of the City, while encouraging excellent architectural design that is responsible and responsive to the individual context of the City's diverse neighborhoods. The single-family regulations, as well as the design and performance standards in the Zoning Code, seek to ensure that the renovation of residences as well as the building of residences is in accord with the civic pride and sense of stewardship felt by the citizens of Coral Gables. By preserving the community character of the Gables, the Zoning Code safeguards both individual property values, as well as the quality of life that best serves the collective interest. In an SFR District no use other than these listed below shall be permitted. No buildings or premises shall be used, nor shall any building or structure be erected, altered or enlarged which is arranged, intended or designed to be used for a use other than a single-family use as defined in this code.
- B. Permitted principal uses and structures. The following uses are permitted:
1. Accessory dwelling.
  2. Accessory uses, buildings or structures as provided in Article 4, Table No. 2. Accessory uses, buildings or structures customarily associated with permitted uses within this Zoning District and not listed within the Table No. 2 may be permitted subject to Development Review Official review and approval.
  3. Family day care as required and defined pursuant to Florida Statutes.
  4. Parks, City.
  5. Single-family dwellings.
  6. Utility infrastructure facilities.
- C. Conditional uses. The following uses are permitted in the SFR District as conditional uses, if approved under the provisions of Article 3, Division 4, subject to the standards in this Section and other applicable regulations in Article 5:
1. Private yacht basins.
- D. Performance standards. The following performance standards shall govern the general development of structures in the District. Where there are specific standards for properties that are specifically set forth in the Site Specific Zoning Regulations, the regulations in the Site Specific Zoning Regulations shall apply (see Appendix A).
1. Building sites. Buildings and structures shall be constructed or erected upon a building site containing at least one (1) platted lot, and such building site shall have a minimum street frontage of fifty (50) feet. See also Section 3-206, Building site determination.
  2. Density. One (1) principal building per building site.
  3. Facing of lots and buildings. Every lot shall be deemed to face the street upon which it abuts; if a lot

## ARTICLE 4 - ZONING DISTRICTS

abuts upon more than one street, it shall be deemed to face the street upon which it has the shortest street line; and any building shall face the front of the lot, and be subject to the restrictions governing buildings on each street on which it is deemed to face. The facing of a building site shall be based on the platting of the lots that comprise the building site, except for specific deviations or exceptions prescribed in Section 3-905.

4. Setback requirements. No building or structure, or any part thereof, including porches, projections or terraces, but not including uncovered steps, shall be erected at a lesser distance from the front, side or rear line of any building site than the front, side or rear setback distance, respectively, prescribed and established herein for such building site. Nothing herein shall prohibit a building or structure from having more than the minimum required setbacks.
  - a. Front setback. A minimum front setback of twenty-five (25) feet shall be maintained and required on all building sites except that on existing building sites on platted lots less than seventy-five (75) feet in depth, a minimum front setback of fifteen (15) feet shall be required.
  - b. Side setbacks. Inside lots shall have minimum side setbacks, which total twenty (20%) percent of the width of the lot measured across the front setback line with a minimum total of ten (10) feet and up to a maximum of twenty (20) feet. A minimum side setback of fifteen (15) feet shall be required and maintained from any side line of a building site that abuts upon a street, provided, however, that buildings on corner lots which have one (1) side abutting upon a street on which other lots in the same block face, shall setback a minimum distance from such side street as is provided herein as the minimum front setback for buildings facing such side street. The required side setbacks shall be equal on both sides unless an uneven distribution is used to mitigate an existing contextual condition on the property as determined by the Board of Architects. An existing contextual condition may include but shall not be limited to the location of tree(s), existing structures on the property, or existing non-conforming setback conditions. In no case shall a side setback be less than five (5) feet
  - c. Rear setback. A minimum rear setback of ten (10) feet shall be maintained and required on all buildings.
  - d. Setback from canal, waterway, lake or bay. On all building sites abutting upon a canal, waterway, lake or bay, the minimum setback from the waterway for all buildings, or portions thereof designed or used for occupancy for residential purposes shall be thirty-five (35) feet from the canal, waterway, lake or bay as platted.
5. Setback requirements for auxiliary, accessory buildings and/or structures. Except as specifically prescribed herein to the contrary, auxiliary, accessory buildings and/or structures shall be governed by the same minimum setback requirements as provided for the main or principal building, provided that:
  - a. Except as may be otherwise noted no accessory or auxiliary building or structures may be located in the area between the street and the main residential building or any part thereof.
  - b. In no case shall an auxiliary building or structure be located closer to the front or side street of a lot or building site than the main or principal building.
  - c. One (1) story detached garages located in the rear yard area, with a height that does not exceed sixteen (16) feet above established grade and a floor area that does not exceed three hundred-and-fifty (350) square feet, may have a side setback of five (5) feet and a rear setback of five (5) feet.
6. Height of single-family residence buildings and height of special-use buildings. No single-family building shall be constructed in the City that is more than two (2) stories in height. No subordinate or accessory building permitted by this code as an auxiliary use shall exceed in height the maximum height of the principal building on the building site. Except in Journey's End where

## ARTICLE 4 - ZONING DISTRICTS

single-family residences may have a permitted height of thirty-four (34) feet above established grade, said two (2) stories shall not exceed a height of twenty-nine (29) feet above established grade in all instances including ridgeline, domes, steeples, towers, cupolas, decorative features and such other similar structures, and excluding chimneys having a maximum height of three (3) feet above the ridgeline and a maximum area of seventeen (17) square feet.

7. Height of residences in flood hazard districts. Single-family residences in flood hazard districts shall not exceed a height of two (2) stories or thirty-nine (39) feet above established grade including ridgeline, domes, steeples, towers, cupolas, decorative features and such other similar structures, and excluding chimneys having a maximum height of three (3) feet above the ridgeline and a maximum area of seventeen (17) square feet. That portion of a single-family residence located above the garage in the coastal flood hazard district may in no case be more than one (1) story in height, and may be one (1) story in height, subject to the following conditions and restrictions:
  - a. That the elevation of the garage floor shall not be more than six (6) inches above established grade.
  - b. That the area of the garage shall not exceed a gross floor area of greater than six-hundred (600) square feet or one-third (1/3) of the ground area of the main building on the premises, whichever is greater, including any service or storage, or access area located within the garage.
8. Ground area coverage. Buildings or structures designed and constructed shall not occupy more than thirty-five (35%) percent of the ground area of the building site upon which the building or structure is erected. The area utilized for calculating the maximum ground area coverage for the principal building shall be computed from the exterior face of exterior walls and the exterior face of exterior columns of the ground floor of the building. Cantilevered portions of the building above the ground floor or roof overhangs that are greater than five (5) feet shall be computed in the calculation of the ground area coverage of the principal building. Auxiliary buildings or structures, including swimming pools, may occupy additional ground coverage, but the total ground area occupied by the main building or structure and auxiliary structures shall not exceed forty-five (45%) percent of the building site upon which the structures are located. In no case shall the main building or structure exceed thirty-five (35%) percent of the lot or lots composing the building site. Special Use buildings or structures which may be permitted by ordinance to be located in the SFR District subject to the same minimum ground area coverage as set forth for single-family residences in the SFR District.
9. Maximum square foot floor area for single-family residences. The maximum square foot floor area permitted for single-family residences shall be equal to forty-eight (48%) percent for the first five-thousand (5,000) square feet of building site area and thirty-five (35%) percent for the next five-thousand (5,000) square feet of building site area and thirty (30%) percent for the remainder of the building site area.
10. Determination of maximum square foot floor area. The maximum square foot floor area of a single-family residence shall be the sum of the gross areas of all the floors of the building or buildings, measured from the exterior faces of exterior walls and exterior faces of supporting columns for any floor not enclosed by exterior walls. The Board of Architects may require such changes in the plans and specifications for single-family residences as are necessary or appropriate to the maintenance of a high standard of construction, architecture, beauty, and harmony with the aesthetic quality of the surrounding neighborhood in the carrying out of the provisions of this section of the "Zoning Code."
  - a. In particular, gross floor area shall include the following:

All floor space used for dwelling purpose, such as living rooms, bedrooms, kitchens, utility rooms, mechanical equipment rooms, and any other similar space, no matter where located within a building, including the following:

## ARTICLE 4 - ZONING DISTRICTS

- i. Elevator shafts and stairwells at each floor.
  - ii. The floor space in penthouses, interior balconies and mezzanines.
  - iii. The floor space in auxiliary or accessory buildings.
  - iv. The floor space in screened porches located on the second floor. The floor space in screened porches located on the first floor shall be computed at one-half (1/2) of the square foot floor area contained therein; provided, a covenant is submitted stating that such screen porch will not be enclosed if it will cause the residence to exceed the maximum permitted floor area.
  - v. The floor space in any garage and/or garage storage area shall be computed at three-quarters (3/4) of floor area for one (1) story detached garages located in the rear yard area with a height that does not exceed sixteen (16) feet above established grade and a floor area that does not exceed three-hundred-and-fifty (350) square feet.
  - vi. In those cases where the average floor to the bottom of the structural member of roof support height exceeds thirteen (13) feet clear, without intermediate structural floor members, then that area shall be counted twice in the maximum floor area factor computation.
  - vii. The floor space in roofed terraces, breezeways, and porches located on the second floor.
  - viii. The floor space in interior courtyards and if a portion of the interior court yard is created in whole or in part with a two (2) story portion of the residence then the interior court yard shall count twice.
- b. The following areas or structures shall not be computed into the gross floor area of the building except as stated herein:
- i. Floor space in one (1) story roofed terraces, breezeways, and porches that do not have an average floor to ceiling height that exceeds thirteen (13) feet provided, a covenant is submitted stating that such roofed terrace, and breezeway or porch will not be enclosed if it will cause the residence to exceed the maximum permitted floor area.
  - ii. Floor space in screen enclosures.
  - iii. Carports that consist of a roofed structure that is open on three (3) sides and attached to the main building for the purpose of providing shelter for one (1) or more motor vehicles.
  - iv. Basements.
11. Determination of maximum square foot floor area in flood hazard districts. The maximum square foot floor area of a single-family residence in a flood hazard district shall be the sum of the gross areas of all the floors of the building or buildings, measured from the exterior faces of exterior walls and exterior faces of supporting columns for any floor not enclosed by exterior walls. The Board of Architects may require such changes in the plans and specifications for single-family residences as are necessary or appropriate to the maintenance of a high standard of construction, architecture, beauty and harmony in the carrying out of the provisions of this section of the "Zoning Code."
- a. In particular, gross floor area shall include the following:
- i. All floor space used for dwelling purpose, such as living rooms, bedrooms, kitchens, utility rooms, mechanical equipment rooms, and any other similar space, no matter where located within a building.
  - ii. Elevator shafts and stairwells at each floor.
  - iii. The floor space in penthouses, interior balconies and mezzanines.
  - iv. The floor space in auxiliary or accessory buildings.
  - v. Screened porches shall be computed at one-half (1/2) of the square foot floor area contained therein; provided, a covenant is submitted stating that such screen porch will not be enclosed if it will cause the residence to exceed the maximum permitted floor area.
  - vi. The floor space in any garage or garage and storage area.
  - vii. In those cases where the average floor to the bottom of the structural member of roof support height exceeds fifteen (15) feet clear, without intermediate structural floor

## ARTICLE 4 - ZONING DISTRICTS

members, then that area shall be counted twice in the maximum floor area factor computation.

- b. The following areas or structures shall not be computed into the gross floor area of the building except as stated herein:
  - i. Floor space in roofed terraces, breezeways, and porches, provided, a covenant is submitted stating that such roofed terrace, and breezeway or porch will not be enclosed if it will cause the residence to exceed the maximum permitted floor area.
  - ii. Floor space in screen enclosures.
  - iii. Carports that consist of a roofed structure that is open on three (3) sides and attached to the main building for the purpose of providing shelter for one (1) or more motor vehicles.
  - iv. Basements.
12. **Garage facades.** A garage that faces upon a street shall not exceed one-third (1/3) of the width of the façade of the residence that faces upon a street and the remaining two-third (2/3) of the façade shall not include other garage areas or detached garages visible from the front of the street. In the event a building site has less than fifty (50) feet of street frontage or does not have sufficient depth on a side street to provide a garage, then a one (1) car garage with a maximum interior dimension of twelve (12) feet by twenty-five (25) feet deep shall be permitted to face upon the front street.
13. Carport canopies are prohibited in SFR zoning districts. Existing carport canopies in SFR zoning districts shall be considered as nonconforming and are subject to the provisions in Article 6.
14. Architectural style. See Article 5, Division 6.

### Section 4-102. Multi-Family 1 Duplex (MF1) District.

- A. **Purpose and applicability.** The Multi-Family 1 Duplex (MF1) District is intended to accommodate low density, duplex dwelling units with adequate yards and open space to characterize a residential environment. In an MF1 District no buildings or premises shall be used, nor shall any building or structure be erected, altered or enlarged which is arranged, intended or designed to be used, for a use other than uses permitted in the district.
- B. **Permitted principal uses and structures.** The following uses are permitted in the MF1 district:
  1. Accessory uses, buildings or structures as provided in Article 4, Table No. 2. Accessory uses, buildings or structures customarily associated with permitted uses within this Zoning District and not listed within the Table No. 2 may be permitted subject to Development Review Official review and approval.
  2. Duplex dwellings.
  3. Family day care as required and defined pursuant to Florida Statutes.
  4. Parks, City.
  5. Single-family dwellings that conform to the standards for single-family residences in an SFR District.
  6. Utility infrastructure facilities.
- C. **Conditional uses.** The following uses are permitted in the MF1 District as conditional uses, if approved under the provisions of Article 3, Division 4, subject to the standards in this Section and other applicable regulations in Article 5:
  1. Private yacht basins.

## ARTICLE 4 - ZONING DISTRICTS

11. **Parking garages.** In the event that structured parking is to be constructed above grade, the facades of the garage shall be designed and improved so that the use of the building as a garage is not readily apparent. That portion of the parking garage that is constructed at ground level shall be screened from street view with living units, portions of living units, or other usable building area, except for vehicular entrance and exit areas. Entrances and exits to garage areas shall have gates that at least partially conceal the interior of the garage from street view. The sides and if necessary the rear of parking structures shall be screened from view of the street with a combination of walls and landscaping as shall be approved by the Board of Architects.
12. **Refuse and waste disposal facilities.** Refuse and waste disposal facilities shall be enclosed within a building or structure which reflects the architectural character and exterior finishes of the building which is to be served by the facilities. An enclosure used exclusively for refuse and waste facilities may be located in a required front setback area.
13. **Minimum dwelling unit floor area.** Each dwelling unit shall have a minimum floor area of five-hundred-seventy-five (575) square feet.
14. **Architectural style.** See Article 5, Division 6.

### **Section 4-104. Multi-Family Special Area (MFSA) District.**

- A. **Purpose and applicability.** The purpose of the Multi-Family Special Area (MFSA) District is to accommodate various forms of multi-family housing to meet the housing needs of a diverse community, while ensuring that there is a transition to single-family neighborhoods which protects the integrity of those neighborhoods.
- B. **Permitted principal uses and structures.** The following uses are permitted:
  1. Accessory uses, buildings or structures as provided in Article 4, Table No. 2. Accessory uses, buildings or structures customarily associated with permitted uses within this Zoning District and not listed within the Table No. 2 may be permitted subject to Development Review Official review and approval.
  2. Duplex dwellings that conform to the performance standards for duplex buildings in an MF1 District.
  3. Family day care as required and defined pursuant to Florida Statutes.
  4. Multi-family dwellings.
  5. Parks, City.
  6. Single-family dwellings that conform to the standards for single-family residences in an SFR District.
  7. Townhouse/row house dwellings.
  8. Utility infrastructure facilities.
- C. **Conditional uses.** The following uses are permitted in the MFSA District as conditional uses, if approved under the provisions of Article 3, Division 4, subject to the standards in this Section and other applicable regulations in Article 5:
  1. Assisted living facilities (ALF).
  2. Bed and breakfast establishments.

## ARTICLE 4 - ZONING DISTRICTS

3. Private yacht basins.
- D. Performance standards. The following performance standards shall govern the general development of structures in this District. Where there are specific standards for properties that are specifically set forth in the Site Specific Zoning Regulations, the regulations in the Site Specific Regulations shall apply (see Appendix A).
  1. Building sites. Buildings and structures constructed in this District shall be constructed or erected upon a building site containing at least one (1) platted lot, and such building site shall have a minimum street frontage of fifty (50) feet.
  2. Minimum parcel dimensions.
    - a. Buildings with a height of less than seventy (70) feet. Multi-family dwellings shall be depth of not

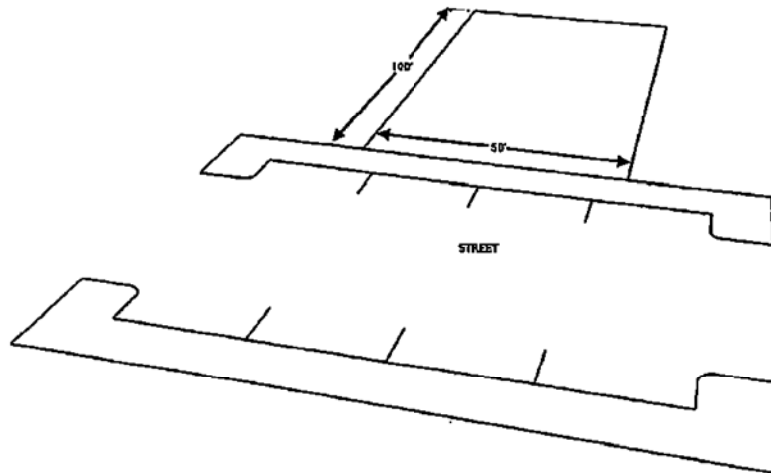



## ARTICLE 4 - ZONING DISTRICTS

- b. Buildings with a height of seventy (70) feet or greater. Multi-family dwellings with a height of seventy (70) feet or greater shall be constructed on a parcel of land with an area of not less than twenty thousand (20,000) square feet and at least one hundred (100) feet of frontage on a public road.

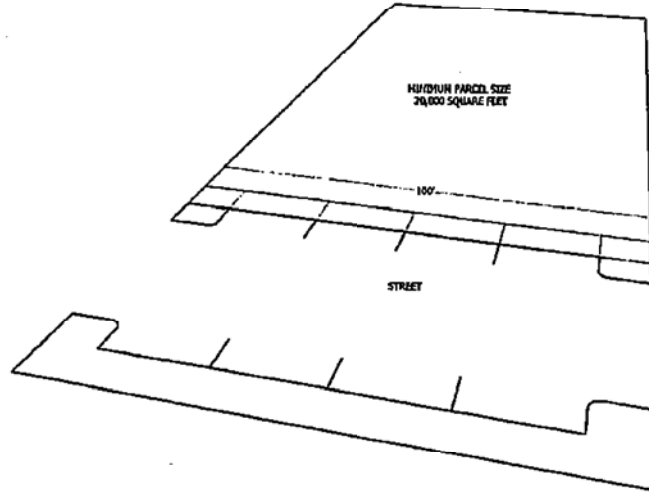

- c. Townhouses/row houses. Minimum building/parcel width of twenty-two (22) feet.
3. Maximum density. Sixty (60) dwelling units per acre or the density provided in the Comprehensive Plan, with architectural incentives, whichever is less.
4. Facing of lots and buildings.
- a. The facing of a building site shall be based on the platting of the lots that comprise the building site, except for specific deviations or exceptions prescribed in the Site Specific Zoning Regulations in Appendix A.
- b. Every lot shall be deemed to face the street upon which it abuts; if a lot abuts upon more than one (1) street, it shall be deemed to face the street upon which it has the shortest street line; and any building shall face the front of the lot, and be subject to the restrictions governing buildings on each street on which it is deemed to face.
- c. Townhouse/row house units on a street shall be designed in a row house building typology that is oriented towards the street. All units shall have their primary pedestrian entrance facing and visible from a street, with off-street parking accessed from the rear of the property.
5. Setback requirements. No building or structure, or any part thereof, including porches, projections or terraces, but not including uncovered steps, shall be erected at a lesser distance from the front, side or rear line of any building site than the front, side or rear setback distance, respectively, prescribed and established herein for such building site.

## ARTICLE 4 - ZONING DISTRICTS

- a. Front setback. The front setback shall also be a build to line for the ground level of any building.

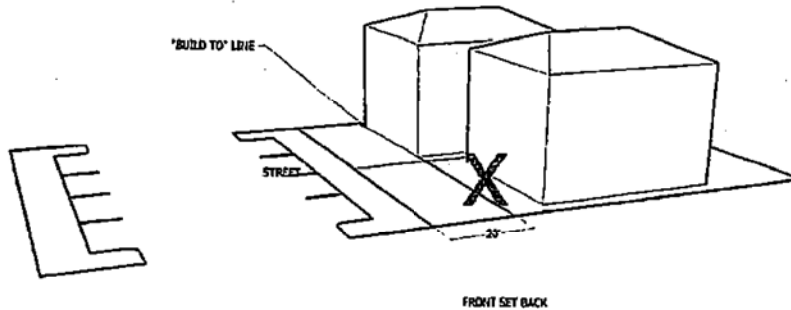

- i. Townhouses/row houses with a height of forty-five (45) feet or less. Ten (10) feet.
- ii. Buildings with a height of forty-five (45) feet or less. Twenty (20) feet.
- iii. Buildings with a height greater than forty-five (45) feet. Twenty (20) feet, provided however, that any portion of a building which has a height of greater than twenty-four (24) feet, shall be set back an additional ten (10) feet.

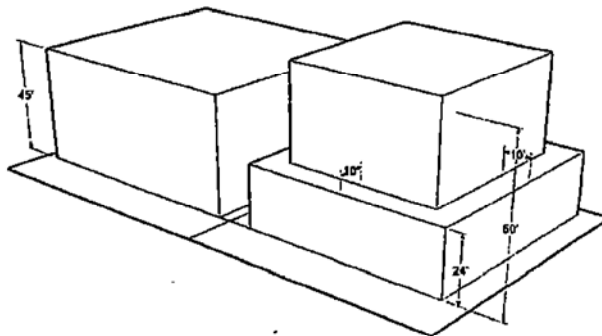

- iv. Adjustment to front setback. In the event that there is public right-of-way between the edge of street pavement and the front property line of the parcel proposed for development, the required front setback shall be reduced by the distance between the edge of pavement and the front property line; provided however, that in no case shall a building be constructed within five (5) feet of the front property line.

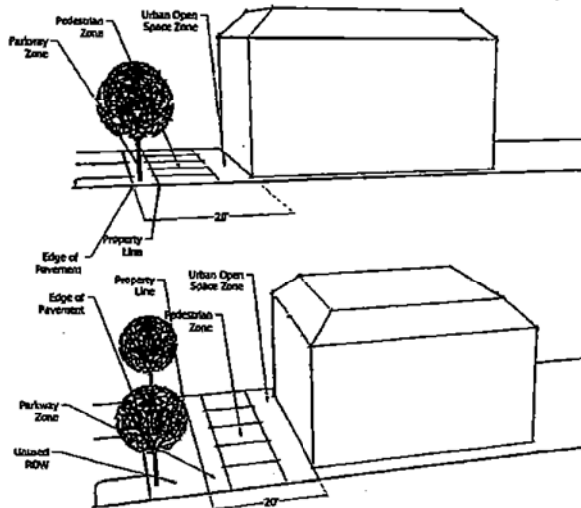

## ARTICLE 4 - ZONING DISTRICTS

- b. Side setbacks.
    - i. Interior property line and abutting alley side setback.
      - (a) Townhouses with a height of forty-five (45) feet or less. None.
      - (b) Buildings with a height of forty-five (45) feet or less. Five (5) feet.
      - (c) Buildings with a height of greater than forty-five (45) feet. Ten (10) feet, provided however, that any portion of a building which has a height of greater than twenty-four (24) feet, shall be set back an additional ten (10) feet.
    - ii. Abutting a public street.
      - (a) Buildings with a height of forty-five (45) feet or less. Ten (10) feet.
      - (b) Buildings with a height of greater than forty-five (45) feet. Ten (10) feet, provided however, that any portion of a building which has a height of greater than twenty-four (24) feet, shall be set back an additional five (5) feet.
  - c. Rear setback. Ten (10) feet or five (5) feet if rear property line abuts an alley.
6. Floor area ratio. Maximum floor area ratio (FAR) shall not exceed 2.0.
7. Determination of maximum square foot floor area or FAR. The total floor area of a building or buildings on a building site divided by the area of the site. The total floor area shall include the gross horizontal area of the several stories of any building or buildings on the site, as measured from the exterior face of exterior walls (not the windows or doors in the exterior walls), and shall include any building area not specifically excluded by this section as floor area excluded from computing the FAR of a building or buildings. The floor area of a building that is excluded from the determination of a buildings floor area ratio in this District shall include the following:
- a. Unenclosed private balconies.
  - b. Off-street parking garages.
  - c. Lobbies and corridors on the ground floor of the building.
  - d. Corridors located above the ground floor that are at least fifty (50%) percent open and unenclosed.
  - e. Open stairwells.
8. Height. The maximum permitted height is as follows:
- a. Pursuant to the Comprehensive Plan Map designation and/or Site Specific Zoning regulations.
  - b. MFSA properties shall have a height limitation of thirty five (35) feet within fifty (50) feet of an adjacent, abutting or contiguous (including streets, waterways, or alleys) SFR and/or MF1 property, as measured from the MFSA property line. MFSA properties shall have a height limitation of three (3) floors or forty-five (45) feet, whichever is less, on the remaining portions adjacent, abutting or contiguous (including streets, waterways, or alleys) to an SFR and/or MF1 property.
  - c. Parcels of land which are contiguous or adjacent to MF1 Districts or land designated as public buildings and grounds. Forty-five (45) feet.
  - d. Parcels of land designated Comprehensive Plan Residential Use - multi-family low-density.
    - i. Parcels of land which are contiguous or adjacent to parcels designated residential use - multi-family low-density land use designations: forty-five (45) feet.

## ARTICLE 4 - ZONING DISTRICTS

- ii. Parcels of land which are contiguous or adjacent to other parcels designated residential use - multi-family medium density land use designations: forty-five (45) feet.
  - iii. Parcels of land which are contiguous or adjacent to parcels designated residential use - multi-family high density or commercial use high-rise intensity land use designations: sixty (60) feet.
- e. Parcels of land designated Comprehensive Plan Residential Use - multi-family medium-density.
- i. Parcels of land which are contiguous or adjacent to parcels designated residential use - multi-family low-density land use designations: sixty (60) feet.
  - ii. Parcels of land which are contiguous or adjacent to parcels designated residential use - multi-family medium-density land use designations: sixty (60) feet or seventy (70) feet if a parcel of land has an area of twenty-thousand (20,000) square feet or more.
  - iii. Parcels of land which are contiguous or adjacent to parcels designated residential use - multi-family high-density or commercial use high-rise intensity land use designations: sixty (60) feet or one-hundred (100) feet if a parcel of land has an area of twenty-thousand (20,000) square feet or more.
- f. Parcels of land designated Comprehensive Plan Residential Use - multi-family high-density.
- i. Parcels of land which are contiguous or adjacent to parcels designated residential use - multi-family low-density land use designations: sixty (60) feet or seventy (70) feet if a parcel of land has an area of twenty-thousand (20,000) square feet or more.
  - ii. Parcels of land which are contiguous or adjacent to parcels designated residential use - multi-family medium-density land use designations:
    - (a) Sixty (60) feet if a parcel of land is less than ten-thousand (10,000) square feet, or seventy (70) feet if a parcel of land has an area of ten-thousand (10,000) square feet or greater but less than twenty-thousand (20,000) square feet; or,
    - (b) One hundred (100) feet if a parcel of land has an area of twenty-thousand (20,000) square feet or more.
  - iii. Parcels of land which are contiguous or adjacent to other parcels designated residential use - multi-family high-density or commercial use high-rise intensity land use designations: sixty (60) feet or one-hundred-fifty (150) feet if a parcel of land has an area of twenty-thousand (20,000) square feet or more.
- g. Parcels of land abutting existing buildings with non-conforming heights. Notwithstanding any other provision of this Subsection 8, a parcel of land which is proposed for development which abuts parcels of land on three (3) sides improved with existing buildings with heights exceeding the maximum permitted height shall have a maximum permitted height of the lowest height of the three (3) buildings on the parcels abutting the parcel proposed for development.

## ARTICLE 4 - ZONING DISTRICTS

h. Height summary. The following matrix summarizes the provisions of Subsection 8, a-f:

<i>Maximum height</i>						
	<i>Parcel size</i>	<i>SFR</i>	<i>MF1</i>	<i>MF L</i>	<i>MF M</i>	<i>MF H</i>
<i>MF L</i>		35'	45'	45'	45'	60'
<i>MF M</i>	<20 K	35'	45'	60'	60'	60'
	>20 K	35'	45'	60'	70'	100'
<i>MF H</i>	<10 K	35'	45'	60'	60'	60'
	10K – 20K	35'	45'	60'	70'	70'
	>20 K	35'	45'	70'	100'	150'

"SFR" means any of the SFR District in the Zoning Code.

"MF1" means any of the MF1 District in the Zoning Code.

"MF L" means the residential multi-family low density category in the Comprehensive Plan.

"MF M" means the residential multi-family medium density category in the Comprehensive Plan.

"MF H" means the residential multi-family high density category in the Comprehensive Plan.

i. The maximum permitted height is measured from established grade to the flat roof deck and when there is no flat roof deck the height shall be to the tie-beam on the top floor of the building. Mechanical equipment areas and decorative roof structures may extend beyond the permitted height a total of ten (10) feet. When more than one (1) of the following conditions occurs for a specific property, the more restrictive condition shall apply.

### 9. Streetscape standards.

a. Streetscape required. The developer of all new residential buildings shall be responsible for the improvement of the area between the front set back and edge of pavement as an urban or suburban streetscape. If the parcel of land proposed for development is adjacent to parcels of land designated multi-family high density or multi-family medium density, then an urban streetscape shall be required. If the parcel of land proposed for development is designated multi-family low density and is adjacent to parcels of land designated multi-family low density, then a suburban streetscape shall be required. Any improvements constructed within the public right-of-way shall be dedicated to and maintained by the City.

b. Minimum width of required streetscape. An urban streetscape shall have a minimum width of twenty-nine (29) feet. A suburban streetscape shall have a minimum width of fifteen (15) feet.

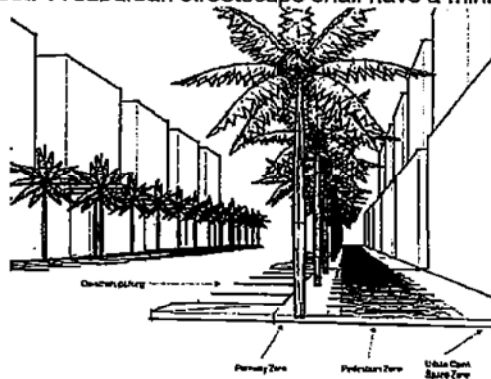

c. Required urban streetscape elements. The required urban streetscape shall be comprised of four (4) zones:

## ARTICLE 4 - ZONING DISTRICTS

- i. On-street parking zone.
  - ii. A parkway zone of at least four (4) feet in width.
  - iii. A pedestrian zone of at least eight (8) feet in width except that the zone width may be reduced to six (6) feet where the existing sidewalks adjacent to the parcel proposed for development are five (5) feet or less.
  - iv. An urban open space zone located between the building and the pedestrian zone, except that no urban open space zone shall be required for townhouses.
- d. Required suburban streetscape elements. The required suburban streetscape shall be comprised of two (2) zones:
- i. A parkway zone of at least four (4) feet in width.
  - ii. A pedestrian zone of at least six (6) feet in width.
  - iii. If the placement of streetscape elements results in removal of existing on-street parking, the Directors of Public Service and Public Works may reduce the required elements to provide for the preservation of the existing on-street parking.
- e. On-street parking requirements. Parallel parking spaces shall be provided within the public right-of-way with dimensions of nine (9) feet by twenty (20) feet. Parallel parking spaces shall be separated with "landscape bulb outs" or pedestrian crosswalks so that no more than six (6) spaces shall be contiguous to one another. If the placement of the spaces results in removal of existing on-street over story trees, the Directors of Public Service and Public Works may reduce the on-street parking requirement to provide for the preservation of the existing over story trees.
- f. Parkway zone requirements.
- i. At least twenty-five (25%) percent of the parkway zone shall be landscaped with groundcover, flower planters or tree grates.
  - ii. Street trees shall be located in the parkway zone on thirty (30) foot centers.
  - iii. Portions of the parkway zone which are not landscaped shall be improved with pavers.
  - iv. Planters shall not be located in those portions of the parkway zone which are contiguous to parking spaces in an on-street parking zone.
  - v. Pavers shall be Coral Gables beige with neutral borders and internal patterns.
  - vi. The pedestrian zone shall be free of obstacles such as street furniture and landscaping.
- g. Urban open space zone.
- i. The urban open space zone shall be improved with:
    - (a) Landscape, hardscape or a mix of landscape and hardscape material.
    - (b) Water features, fountains, planters, street lighting and street furniture.
    - (c) Entrance features including steps may be located within the zone.
  - ii. If the urban open space zone is located on private property, the zone may be enclosed with ornamental fencing not to exceed five (5) feet in height. No more than thirty five (35%) percent of the fencing shall be solid and the fencing shall have gates to allow residents to access the pedestrian zone of the required streetscape.
  - iii. Include one (1) tree of at least fourteen (14) feet in overall height per one hundred twenty-five (125) square feet of required open space area.
- h. Building facades. Building facades abutting the required streetscape shall be animated by windows, shutters, planters, columns, relief elements, and other architectural details to give character to the street. All windows shall be recessed at least four (4) inches.
- i. Parking garages.

## ARTICLE 4 - ZONING DISTRICTS

- i. No portion of a building which is above grade and within twenty (20) feet of the front setback line shall be used for the storage of vehicles or off-street parking unless the façade is treated with a decorative wall or fence of four and one-half (4½) feet in height along the portion of the building used for off-street parking, with landscaping and urban open space which screens the building to a height of at least seven (7) feet at time of planting.

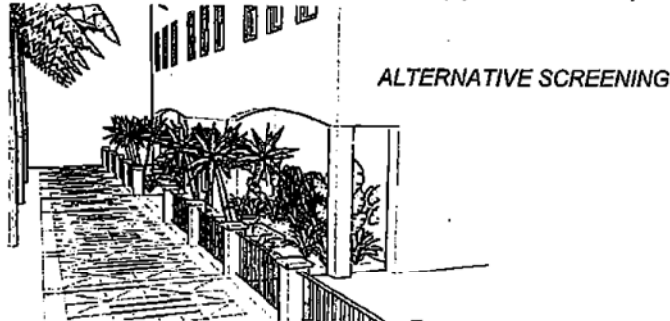

- ii. In the event that structured parking is to be constructed above grade, the facades of the garage shall be designed and improved so that the use of the building as a garage is not readily apparent.
  - iii. Parking garages shall reflect the architectural character and exterior finishes of the building which is to be served by the garage.
- j. Refuse and waste disposal facilities. Refuse and waste disposal facilities shall be enclosed within a building or structure which reflects the architectural character and exterior finishes of the building which is to be served by the facilities. An enclosure used exclusively for refuse and waste facilities may be located in a required front setback area.
  - k. Architectural standards. See Article 5, Division 6.
  - l. All development shall comply with Article 5, Division 6 for residential uses which are set out in Table 1 of Division 6 and five (5) of ten (10) of the standards in Table 2 of Division 6; however, the bonus intensity and heights shall not apply.

### Division 2. Overlay and Special Purpose Districts

#### Section 4-201. Mixed Use District (MXD).

##### A. Purpose. The purpose of this District is to:

1. Provide the method by which tracts of land may be developed as a planned unified project rather than on a lot-by-lot basis as provided for in the City's other regulations.
2. Provide for residential uses at higher densities in exchange for public realm improvements.
3. Provide maximum design freedom by permitting property owners an opportunity to more fully utilize the physical characteristics of the site through modified development regulations and the planned mixing of uses.
4. Require that property within the District will be developed through a unified design providing continuity among the various elements causing a better environment.
5. Create a diversity of uses within walking distance, including but not limited to: residential, offices, workplaces, neighborhood commercial, and public open spaces including the following attributes:
  - a. Provide a variety of uses in the area which can be traversed in a ten (10) minute walk which

## ARTICLE 4 - ZONING DISTRICTS

and the subject properties shall be considered as if they were a single building site for all purposes under these regulations and such application shall be subject to the following requirements:

1. The properties shall be designated High-Rise Intensity Commercial Land Use on the Comprehensive Plan Map from the right-of-way line of Miracle Mile north to Aragon Avenue and the right-of-way line of Miracle Mile south to Andalusia Avenue.
2. The building height of the development of the properties shall be limited to not more than six (6) stories or seventy (70) feet of building height or, whichever is less, for properties from Miracle Mile to the centerline of the alley to the north or south of Miracle Mile.
3. A minimum of ninety (90%) percent of the lot front facing Miracle Mile, at ground level, shall be storefronts limited to retail, restaurant, art galleries, personal services, courtyards and building entries.
4. Except for pedestrian building entrances and pedestrian courtyards there shall be a mandatory zero (0) foot setback along the Miracle Mile frontage and there shall be no side setbacks along Miracle Mile to ensure a continuous pedestrian scale façade.
5. In order to ensure consistency with these regulations and to ensure that the development as proposed will be compatible with and further the development of the pedestrian character and scale of Miracle Mile, all such projects shall be subject to site plan review by the Planning and Zoning Board with recommendation to the City Commission.
6. Where the designated site or project is subject to multiple ownership, as part of the application for site plan review, the Planning and Zoning Board may allow the Owners of the property to submit a Covenant in Lieu of Unity of Title in accordance with the provisions of Article 5, Division 23.
7. Alterations, expansions, renovations, and similar improvements of existing structures shall, to the extent feasible, conform to the requirements of this section and other applicable provisions of these regulations.

### Section 4-204. Special Use (S) District.

- A. Purpose and applicability. The purpose of the Special Use (S) District is to provide a zoning classification which accommodates uses which have the potential of adversely impacting adjacent uses but which enhance the quality of life of the citizens of the City.
- B. Permitted uses. The following uses are permitted subject to the standards in this Section and other applicable regulations in Article 5:
  1. Accessory uses, buildings or structures as provided in Article 4, Table No. 2. Accessory uses, buildings or structures customarily associated with permitted uses within this Zoning District and not listed within the Table No. 2 may be permitted subject to Development Review Official review and approval.
  2. Canopies, including permanent freestanding shelter canopy structure(s) or structure(s) attached to a building.
  3. Botanical gardens with previously approved master plan. Allow for the placement of the following uses to solely serve the patrons of the botanical gardens:
    - a. Offices.
    - b. Research and technology.
    - c. Retail sales and services.



## ARTICLE 4 - ZONING DISTRICTS

- d. Restaurant.
  - e. Educational facility.
  - f. Nighttime uses.
  - g. Outdoor recreation/entertainment.
  - h. Camps.
  - i. Other such uses as are customary for botanical gardens.
- 4. Parks, City.
  - 5. Utility/infrastructure facilities.
  - 6. Temporary uses, in accordance with the provisions of Article 5, Division 21.
- C. Conditional Uses. The following uses are permitted in the S District as conditional uses, if approved under the provisions of Article 3, Division 4, subject to the standards in this Section and other applicable regulations in Article 5:
- 1. Botanical gardens master plan.
  - 2. Camps.
  - 3. Cemeteries.
  - 4. Country clubs.
  - 5. Golf course.
  - 6. Government uses.
  - 7. Heliport and helistop.
  - 8. Hospital and uses accessory to, and customarily associated with, a hospital, as follows:
    - a. Convenience facilities for hospital users such as: snack bar, gift shop, chapel and florist.
    - b. Diagnostic facility.
    - c. Health/fitness facilities.
    - d. Intermediate care facility.
    - e. Laboratory and research facilities.
    - f. Medical clinic and/or office.
    - g. Medical educational facilities.
    - h. Municipal facilities.
    - i. Pharmacy.
    - j. Rehabilitation facilities.

## ARTICLE 4 - ZONING DISTRICTS

- k. Support facilities such as: cafeteria, laundry, dietary services, childcare, administrative offices, data processing and printing.
  - 9. Marina facilities.
  - 10. Municipal facilities.
  - 11. Museum.
  - 12. Open space areas.
  - 13. Private club.
  - 14. Public transportation facilities.
  - 15. Religious Institutions.
  - 16. Schools.
  - 17. Tennis courts.
- D. Performance standards:
- 1. Setbacks:
    - a. Front: Twenty-five (25) feet, except that platted lots less than seventy-five (75) feet in depth, a minimum front setback of fifteen (15) feet shall be required.
    - b. Side:
      - i. Inside lots: Minimum side setbacks which total twenty (20%) percent of the width of the lot measured across the front setback line up to a maximum of twenty (20) feet.
      - ii. Side street: Fifteen (15) feet, provided, however, that buildings on corner lots which have one (1) side abutting upon a street on which other lots in the same block face, shall setback a minimum distance from such side street as is provided herein as the minimum front setback for buildings facing such side street. In no case shall a side setback be less than five (5) feet.
    - c. Rear: Five (5) feet.
    - d. Setback from canal, waterway, lake or bay: Thirty-five (35) feet, except as provided in site specific regulations included as Appendix A.
  - 2. Height: forty-five (45) feet except as provided in Site Specific Zoning Regulations (see Appendix A).
  - 3. Landscaped open space: Not less than thirty-five (35%) percent of the area of the building site.
  - 4. Floor area ratio:
    - a. .35, when adjacent to a single-family residential district.
    - b. 1.0, when not adjacent to a single-family residential district.

### Section 4-205. Preservation (P) District.

- A. Purpose and applicability. The purpose of the Preservation (P) District is for the preservation and conservation of natural and cultural resources and environmentally sensitive lands such as wetlands,

## ARTICLE 4 - ZONING DISTRICTS

- b. No music (live or recorded) shall be performed or played except within an enclosed building between the hours of 8:00 PM and 6:00 AM.
- c. No kitchen with outside venting shall be directed toward residential districts and shall not be operated between the hours of 10:00 PM and 6:00 AM.

### Section 4-302. Commercial District (C).

- A. Purpose and applicability. The purpose of the Commercial (C) District is to provide convenient access to higher intensity goods and services throughout the City in conjunction with providing economic stability without adversely impacting the integrity of residential neighborhoods, diminishing the scenic quality of the City or negatively impacting the safe and efficient movement of people and things within the City.
- B. Permitted uses. The following uses are permitted subject to the standards in this Section and other applicable regulations in Article 5:
  - 1. Accessory uses, buildings or structures as provided in Article 4, Table No. 2. Accessory uses, buildings or structures customarily associated with permitted uses within this Zoning District and not listed within the Table No. 2 may be permitted subject to Development Review Official review and approval.
  - 2. Alcoholic beverage sales.
  - 3. Animal grooming and boarding.
  - 4. Automobile service station.
  - 5. Camps.
  - 6. Community center.
  - 7. Congregate care.
  - 8. Day care.
  - 9. Educational facilities.
  - 10. Funeral home.
  - 11. Government uses.
  - 12. Indoor recreation/entertainment.
  - 13. Medical clinic.
  - 14. Municipal facilities.
  - 15. Museum.
  - 16. Nighttime uses.
  - 17. Nursing homes.
  - 18. Offices.

## ARTICLE 4 - ZONING DISTRICTS

19. Overnight accommodations.
  20. Parking garages.
  21. Parking lots.
  22. Parks, City.
  23. Public transportation facility.
  24. Restaurants.
  25. Restaurants, fast food.
  26. Retail sales and services.
  27. Swimming pools as an accessory use.
  28. Temporary uses.
  29. TV/radio studios.
  30. Utility/infrastructure facilities.
  31. Vehicle sales/displays.
  32. Vehicle service, major.
  33. Veterinary offices.
- C. Conditional uses. The following uses are permitted as conditional uses, if approved under the provisions of Article 3, Division 4, subject to the standards in this Section and other applicable regulations in Article 5:
1. Assisted living facilities (ALF).
  2. Drive through facilities.
  3. Helistop.
  4. Marina facilities.
  5. Medical Marijuana Retail Center, unless prohibited under state or federal law, subject to all of the following additional requirements:
    - a. Application. In addition to meeting the application requirements for a Medical Marijuana Permit in Chapter 14 "Businesses," Article 5 "Marijuana Sales" of the City Code of Ordinances, an application for conditional use approval for a Medical Marijuana Retail Center shall:
      - i. Be a joint application by the property owner and the tenant, if the Medical Marijuana Treatment Center and the property are not owned by the same person or entity;
      - ii. Be accompanied by a lease identifying the specific use, if the Medical Marijuana Treatment Center and the property are not owned by the same person or entity;
      - iii. Include a survey sealed by a registered land surveyor who is licensed by the State of Florida. The survey shall indicate the distance between the proposed Medical Marijuana Retail Center and any other Medical Marijuana Retail Center, SFR or MF1 zoning district,

## ARTICLE 4 - ZONING DISTRICTS

- elementary, middle or secondary school, child day care facility, county or municipal park, or place of worship, as identified in Section 4-302(C)4.b;
- iv. Conduct the public information meeting required pursuant to Section 3-302(D). Notice of the public information meeting shall be provided to all property owners and tenants within 1,000 feet of the property on which the Medical Marijuana Retail Center is proposed; and
  - v. Provide, in addition to the quasi-judicial notice of conditional use hearings to property owners required by this Code, no later than 10 days prior to each and every public hearing, notice of the public hearing to all tenants within 1,000 feet of the property on which the Medical Marijuana Retail Center is proposed.
- b. Location requirements. A Medical Marijuana Retail Center shall not be located:
- i. Within 500 feet of any SFR or MF1 zoning district;
  - ii. Within 1,000 feet of another Medical Marijuana Retail Center, whether it is located in the City or in another jurisdiction;
  - iii. Within 1,000 feet of a Medical Marijuana Treatment Center located in another jurisdiction (Medical Marijuana Treatment Centers are not allowed in the City);
  - iv. Within 1,000 feet of an elementary, middle or secondary school, child day care facility, county or municipal park, or place of worship; and
  - iv. Within the Central Business District.
- c. Effect of future uses on spacing. Where a Medical Marijuana Retail Center is located in conformity with the provisions of this Chapter, the subsequent locating of one of the uses listed in b. above within the specified distance of an existing Medical Marijuana Retail Center shall not cause a violation of this Section. Whenever a Conditional Use approval for a Medical Marijuana Retail Center has been lawfully procured and thereafter an elementary, middle or secondary school, child day care facility, county or municipal park, or place of worship be established within a distance otherwise prohibited by law, the establishment of such use shall not be cause for the revocation of the Conditional Use approval or related Medical Marijuana Permit or prevent the subsequent renewal of same.
- d. Measurement. Distances shall be measured using an airline measurement from the property line of the property on which the Medical Marijuana Retail Center is located to the nearest property line of the use or zone identified in b.i. through b.iv. that existed before the date the Medical Marijuana Retail Center submitted its initial application for approval.
- e. Building requirements and use.
- i. If the Medical Marijuana Retail Center is located in a freestanding building the Center shall be the only use permitted on the property.
  - ii. If the Medical Marijuana Retail Center is located in a bay or multi-bay space within a multi-tenant structure, the Center shall be the only use permitted within the bay or multi-bay space it occupies.
  - iii. Odor and air quality. A complete air filtration and odor elimination filter and scrubber system shall be provided ensuring the use will not cause or result in dissemination of dust, smoke, or odors beyond the confines of the building, or in the case of a tenant in a multi-tenant building, beyond the confines of the occupied space. A double door system shall be provided at all entrances to mitigate odor intrusion into the air outside the Medical Marijuana Retail Center.
  - iv. Signage. Notwithstanding other provisions of this Code and the City Zoning Code, signage for a Medical Marijuana Retail Center shall be limited as follows:
    - (1) One (1) Wall Sign, not to exceed 18 square feet;
    - (2) No other signage, except as required by this subsection, shall be allowed;
    - (3) Graphics, symbols and logos are prohibited;
    - (4) Neon shall be prohibited;
    - (5) Signs shall not be internally illuminated;

## ARTICLE 4 - ZONING DISTRICTS

- (6) Signs may be externally illuminated only during hours of operation;
- (7) A Medical Marijuana Retail Center shall post, at each entrance to the Medical Marijuana Retail Center the following language:

ONLY INDIVIDUALS WITH LEGALLY RECOGNIZED MARIJUANA OR CANNABIS QUALIFYING PATIENT OR CAREGIVER IDENTIFICATION CARDS OR A QUALIFYING PATIENT'S LEGAL GUARDIAN MAY OBTAIN MARIJUANA FROM A MEDICAL MARIJUANA RETAIL CENTER.

The required text shall be a minimum one-half inch in height.

- f. Queuing of vehicles. The Medical Marijuana Retail Center shall ensure that there is no queuing of vehicles in the adjacent rights-of-way, the drive aisles of the Center's parking lot, or on any adjacent properties. The Medical Marijuana Retail Center shall take all necessary and immediate steps to ensure compliance with this paragraph.
- g. No drive-through service. No Medical Marijuana Retail Center shall have a drive-through service aisle. All activities will occur within an enclosed building.
- h. Prohibited activities. A Medical Marijuana Retail Center shall not engage in any activity other than those activities specifically defined herein as an authorized part of the use. The preparation, wholesale storage, cultivation, or processing of any form of Marijuana or Marijuana product and on-site consumption of any Marijuana or Marijuana product is specifically prohibited. On-site storage of any form of Marijuana or Marijuana product is prohibited, except to the extent reasonably necessary for the conduct of the on-site retail business.
- i. Conditional use duration. A conditional use approval for a Medical Marijuana Retail Center shall be valid for two (2) years, subject to compliance with the conditions of approval and all state and federal laws, licensing and operational requirements. A new conditional use approval must be obtained prior to expiration of the active approval to ensure continued operation.
- j. Revocation of conditional use approval. Any conditional use approval granted under this section shall be immediately terminated if any one or more of the following occur:
  - i. The Applicant provides false or misleading information to the City;
  - ii. Anyone on the premises knowingly dispenses, delivers, or otherwise transfers any Marijuana or Marijuana product to an individual or entity not authorized by state and federal law to receive such substance or product;
  - iii. An Applicant, Owner or manager is convicted of a felony offense;
  - iv. Any Applicant, Owner, manager or Employee is convicted of any drug-related crime under Florida Statutes;
  - v. The Applicant fails to correct any City Code violation or to otherwise provide an action plan to remedy the violation acceptable to the City Manager within 30 days of citation;
  - vi. The Applicant fails to correct any State law violation or address any warning in accordance with any corrective action plan required by the State within the timeframes and completion date the Applicant provided to the City;
  - vii. The Applicant's State license or approval authorizing the dispensing of Medical Marijuana expires or is revoked; or
  - viii. The Applicant fails to maintain a Medical Marijuana Permit as required by Chapter 14 "Businesses," Article 5 "Marijuana Sales" of the City Code of Ordinances.
- k. Transfer of Medical Marijuana Conditional Use Approval.
  - i. A Conditional Use Approval for a Medical Marijuana Retail Center shall not be transferred to a new Owner, or possession, control, or operation of the establishment surrendered to such other person until a new Medical Marijuana Permit has been obtained by the new Applicant in accordance with Chapter 14 "Businesses," Article 5 "Marijuana Sales" of the City Code.

## ARTICLE 4 - ZONING DISTRICTS

- ii. An application for a Conditional Use Approval transfer, meeting the requirements of Section 4-302.C.4.a., shall be filed with the City at the same time the new Applicant files its application for a Medical Marijuana Permit.
  - iii. The Application for a Conditional Use Approval transfer shall be accompanied by a Conditional Use Approval transfer fee to be set by resolution of the Commission.
  - iv. If the new Applicant is granted a Medical Marijuana Permit and the transfer application meets the material requirements of Section 4-302.C.4., the City Manager shall approve the Conditional Use Approval transfer.
  - v. A Conditional Use approval is particular only to the applicant at the approved location and shall not be transferred to another applicant, owner or location.
  - vi. An attempt to transfer a Conditional Use approval either directly or indirectly in violation of this Section is hereby declared void, and in that event the Conditional Use shall be deemed abandoned, and the related Medical Marijuana Permit shall be forfeited.
- 6. Mixed use building(s).
  - 7. Outdoor recreation/entertainment.
  - 8. Private yacht basin.
  - 9. Walk-up counter only as an accessory use to a restaurant.
- K. Performance standards.
- 1. Minimum parcel of land:
    - a. Less than forty-five (45) feet in height shall be a minimum two-thousand-five-hundred (2,500) square feet.
    - b. Greater than forty-five (45) feet in height shall have a minimum of two-hundred (200) feet of primary street frontage and minimum land area of twenty-thousand (20,000) square feet.
  - 2. Minimum parcel dimensions:
    - a. Width. Twenty (25) feet.
    - b. Depth. One-hundred (100) feet.
  - 3. Minimum setbacks. The following setbacks shall be provided for all buildings:
    - a. Front:
      - i. Up to fifteen (15) feet in height: None.
      - ii. The portion of a building above fifteen (15) feet shall be set back ten (10) feet from the property line at the lower of: a) a cornice line above fifteen (15) feet; b) the top of a parking pedestal; or c) forty (40) feet.
    - b. Side:
      - i. Interior side: Up to forty-five (45) feet in height – zero (0) feet, greater than forty-five (45) feet in height – fifteen (15) feet plus one (1) foot of additional setback for each three (3) feet of height above forty-five (45) feet.
      - ii. Side street: Fifteen (15) feet.

## ARTICLE 4 - ZONING DISTRICTS

- c. Rear:
    - i. Abutting a dedicated alley or street: None.
    - ii. Not abutting dedicated alley or street: Ten (10) feet.
  - d. Setback from canal, waterway, lake or bay: On all building sites abutting upon a canal, waterway, lake or bay, the minimum setback from the waterway for all buildings, or portions thereof designed or used shall be thirty-five (35) feet from the canal, waterway, lake or bay as platted.
  - e. Balconies: Cantilevered open balconies may project into the required setback areas a maximum of six (6) feet.
4. Floor area ratio: 3.0.
5. Height. The maximum permitted height is as follows:
- a. Pursuant to the Comprehensive Plan Map designation and/or Site Specific Zoning regulations.
  - b. C properties shall have a height limitation of three (3) floors or forty-five (45) feet, whichever is less, within one-hundred (100) feet of an adjacent, abutting or contiguous (including streets, waterways, or alleys) SFR and/or MF1 property, as measured from the C property line.
6. Nighttime uses adjacent to a residential district.
- a. Parking lots for nighttime uses shall be screened with opaque wall, fences or hedges to a height of a minimum of four (4) feet at time of installation so that vehicle headlamps cannot illuminate land which is designated as a residential district.
  - b. No patron or customer access for nighttime uses which is visible from land designated as a residential district shall be available for use from the hours of 8:00 PM to 6:00 AM.
  - c. No deliveries shall be accepted between the hours of 8:00 PM and 6:00 AM for nighttime uses.
  - d. Windows and doors facing land designated as a residential district shall be opaque or shall be provided with shades, screens, or drapes to screen illumination from within the building.
  - e. A landscape buffer comprised of a continuous hedge and small trees with a height of at least fourteen (14) feet at intervals of not less than ten (10) feet on centers shall be located along any property line of a nighttime use which has a common property line with property designated as a residential district, or is separated only by an alley.
  - f. Signage which is visible from land designated as a residential district shall not be illuminated between the hours of 10:00 PM and 6:00 AM.
  - g. Additional criteria for medical clinics.
    - i. Overnight stays at a medical clinic shall not exceed twenty-four (24) consecutive hours.
    - ii. Overnight stays shall be prohibited on Saturday or Sunday on property that abuts a residential district.
    - iii. Patients shall not be admitted or discharged between the hours of 10:00 PM and 6:00 AM.
    - iv. A maximum of six (6) beds or sleeping rooms shall be permitted, and a total of six (6) patients at one time may remain overnight in any medical clinic, regardless of the number of medical personnel affiliated with such clinic.
    - v. The medical clinic shall be closed to the public between the hours of 10:00 PM and 6:00 AM.
    - vi. All doors in the medical clinic that face a residential district shall remain closed at all



## ARTICLE 4 - ZONING DISTRICTS

times between the hours of 10:00 PM and 6:00 AM.

- vii. No loitering of any kind shall be permitted in any area which is visible from land which is designated as a residential district.
  - viii. Compliance with all applicable federal, state, and local laws, including, without limitation, all licensing requirements.
- h. Overnight accommodations.
- i. No outdoor facilities, including pools, decks, outdoor dining or drinking facilities which are visible from land designated residential shall be used or operated after 10:00 PM.
  - ii. No music (live or recorded) shall be performed or played except within in an enclosed building between the hours of 8:00 PM and 6:00 AM.
  - iii. No kitchen with outside venting shall be operated between the hours of 10:00 PM and 6:00 AM.
7. Additional standards for mixed-use development.
- a. Mix of uses. In order to encourage the creative mix of uses, all mixed-use developments shall have at least eight (8%) percent of the entire ground floor of retail commercial and/or office uses. The remaining portions of the building may be uses permitted in the underlying zoning designations.
  - b. Floor area ratio. When multiple uses are incorporated into a development of four (4) or more stories in height, the floor area ratio (FAR) for each use shall be individually determined and the highest of the individual FAR shall be applied to the entire development.
  - c. Ground floor treatment. Ground floor treatment for all Mixed-Use development shall be pedestrian oriented, and shall detail the percent glazing to solids, pedestrian-oriented landscaping and other features when submitting to the Board of Architects and Planning and Zoning Board.

### Section 4-303. Industrial District (I).

- A. Purpose. The purpose of the Industrial (I) District is to accommodate related industrial uses in the City.
- B. Permitted uses. The following uses are permitted subject to the standards in this Section and other applicable regulations in Article 5:
- 1. Accessory uses, buildings or structures as provided in Article 4, Table No. 2. Accessory uses, buildings or structures customarily associated with permitted uses within this Zoning District and not listed within the Table No. 2 may be permitted subject to Development Review Official review and approval.
  - 2. Alcoholic beverage sales, including wine shops and similar uses.
  - 3. Animal grooming or boarding.
  - 4. Automobile service stations.
  - 5. Camps.
  - 6. Commercial laundry.
  - 7. Community center.
  - 8. Day care.